

<https://doi.org/10.21122/1029-7448-2018-61-5-385-395>

UDC 621.383.51

Simulation of Tandem Thin-Film Solar Cell on the Basis of CuInSe_2

A. K. Esman¹⁾, V. K. Kuleshov²⁾, V. A. Potachits¹⁾, G. L. Zykov¹⁾

¹⁾Belarusian National Technical University (Minsk, Republic of Belarus),

²⁾The University of Civil Protection of the Ministry for Emergency Situations of the Republic of Belarus (Minsk, Republic of Belarus)

Abstract. CuInSe_2 thin-film solar cells are promising materials for photovoltaic devices. One of the main tasks of researchers is to find ways to increase the solar cells efficiency. In this paper we propose an original structure of a thin-film solar cell based on a tandem connection of a photoelectric converter and a thermoelectric layer based on CuInSe_2 . The photoelectric converter consists of CuInSe_2 and CdS layers. A 3D model of the proposed thin-film solar cell was implemented in the COMSOL Multiphysics environment with using the Heat Transfer module. The simulation was carried out taking into account the diurnal and seasonal variations of both the ambient temperature and the power density of the AM1.5 solar spectrum for the geographical coordinates of Minsk. The solar radiation power density of about 500 kW/m^2 can be achieved by using concentrators. The temperature pattern and temperature gradients are calculated in each layer of the solar cell without and with the temperature stabilization of the substrate back side as well as without and with the thermal insulation of the substrate ends. Graphs of the temperature gradients of the thermoelectric layer and the temperature variations of the photoelectric converter of the solar cell are given. As a result of the simulation, it is shown how the uneven heating of both the surface of a thin-film solar cell and its layers occur under conditions of diurnal and seasonal variations of both the ambient temperature and the solar radiation power density. Under concentrated solar radiation exposure, the photoelectric converter surface can be heated up to $700 \text{ }^\circ\text{C}$ without temperature stabilization of the solar cell substrate. The operating temperature of the photoelectric converter was maintained at no more than $2.35 \text{ }^\circ\text{C}$ in January and at no more than $14.23 \text{ }^\circ\text{C}$ in July due to the temperature stabilization of the substrate back side of the proposed device. This made it possible to achieve an increase in the output power of the solar cell both by summing the photo- and thermoelectric output voltages and by the concentration of solar radiation.

Keywords: CuInSe_2 thin-film solar cell, numerical simulation, COMSOL Multiphysics, thermoelectric layer, photoelectric converter, temperature gradient, temperature stabilization, substrate, solar concentrator

For citation: Esman A. K., Kuleshov V. K., Potachits V. A., Zykov G. L. (2018) Simulation of Tandem Thin-Film Solar Cell on the Basis of CuInSe_2 . *Energetika. Proc. CIS Higher Educ. Inst. and Power Eng. Assoc.* 61 (5) 385–395. <https://doi.org/10.21122/1029-7448-2018-61-5-385-395>

Адрес для переписки

Есман Александр Константинович
Белорусский национальный технический университет,
ул. Б. Хмельницкого, 9,
220013, г. Минск, Республика Беларусь
Тел.: +375 17 331-00-50
ak_esman@bntu.by

Address for correspondence

Esman Alexander K.
Belarusian National Technical University,
9 B. Khmel'nitskogo str.,
220013, Minsk, Republic of Belarus
Tel.: +375 17 331-00-50
ak_esman@bntu.by

Моделирование тандемного тонкопленочного солнечного элемента на основе CuInSe_2

А. К. Есман¹⁾, В. К. Кулешов²⁾, В. А. Потачиц¹⁾, Г. Л. Зыков¹⁾

¹⁾Белорусский национальный технический университет (Минск, Республика Беларусь),

²⁾Университет гражданской защиты Министерства по чрезвычайным ситуациям Республики Беларусь (Минск, Республика Беларусь)

© Белорусский национальный технический университет, 2018
Belarusian National Technical University, 2018

Реферат. Тонкопленочные солнечные элементы CuInSe_2 зарекомендовали себя как перспективные материалы для солнечной энергетики. Одной из главных задач исследователей является поиск путей повышения эффективности солнечных элементов. В данной работе предложена оригинальная структура тонкопленочного солнечного элемента на основе тандемного соединения фотоэлектрического преобразователя, состоящего из слоев CuInSe_2 и CdS , и термоэлектрического слоя, выполненного на основе CuInSe_2 . Трехмерная модель предлагаемого тонкопленочного солнечного элемента была реализована в программной среде COMSOL Multiphysics с использованием модуля «Теплопередача». Моделирование осуществлялось для географических координат г. Минска с учетом суточного и сезонного изменения как температуры окружающей среды, так и плотности мощности солнечного излучения спектра AM1.5, максимальное значение которой может быть достигнуто порядка 500 кВт/м^2 при использовании концентраторов. Рассчитано распределение температуры и градиентов температуры в каждом слое солнечного элемента без стабилизации и со стабилизацией температуры тыльной стороны подложки, а также при отсутствии и наличии теплоизоляции торцов подложки. Приведены графики градиентов температуры термоэлектрического слоя и изменения температуры фотоэлектрического преобразователя солнечного элемента. В результате моделирования показано, в какой степени происходит неравномерный нагрев как поверхности тонкопленочного солнечного элемента, так и его слоев в условиях суточного и сезонного изменения температуры и плотности мощности солнечного излучения. При воздействии концентрированного солнечного излучения поверхность фотоэлектрического преобразователя солнечного элемента без термостабилизации подложки может нагреваться до $700 \text{ }^\circ\text{C}$. Рабочая температура фотоэлектрического преобразователя на уровне не более $2,35 \text{ }^\circ\text{C}$ в январе и $14,23 \text{ }^\circ\text{C}$ в июле поддерживалась за счет термостабилизации тыльной стороны подложки предложенного устройства. Это позволило достичь увеличения выходной мощности солнечного элемента как путем суммирования фото- и термоэлектрических выходных напряжений, так и концентрации солнечного излучения.

Ключевые слова: тонкопленочный солнечный элемент CuInSe_2 , численное моделирование, COMSOL Multiphysics, термоэлектрический слой, фотоэлектрический преобразователь, градиент температуры, термостабилизация, подложка, концентратор солнечного излучения

Для цитирования: Моделирование тандемного тонкопленочного солнечного элемента на основе CuInSe_2 / А. К. Есман [и др.] // *Энергетика. Изв. высш. учеб. заведений и энерг. объединений СНГ*. 2018. Т. 61, № 5. С. 385–395. <https://doi.org/10.21122/1029-7448-2018-61-5-385-395>

Introduction

Development and study of the properties of thin-film solar cells is one of the topical problems of modern semiconductor power industry [1]. Copper indium selenide (CuInSe_2) has recently been used as a material of such elements [2–5]. It most fully meets the requirements for use in terrestrial conditions, owing to its narrow band gap (1.04 eV at 300 K), presence of homo- and heterojunctions, flexibility [6], high radiation resistance, environmental safety and cost.

Experimental studies show that long-term operation of solar cells leads to a decrease in their operational efficiency and a service life [7] due to their heating above ambient temperatures (up to 50–55 °C and more). Therefore, it is of interest to search for efficient ways of reducing the operating temperature of the solar cell and increasing the solar photovoltaic conversion efficiency [8–12].

The purpose of this paper is to develop methods for increasing the solar photovoltaic conversion efficiency of a thin-film semiconductor cell based on CuInSe_2 by using both the thermal energy released in this cell and the infrared radiation of the sun and the environment.

Construction of the thin-film solar cell

The structure of the proposed thin-film solar cell based on CuInSe_2 is shown in the fig. 1 [9], where the first electrode layer 2, the thermoelectric layer 3 based on CuInSe_2 , the second electrode layer 4, the photoelectric converter 5 and 6 consisting of CuInSe_2 and CdS layers respectively, as well as a transparent electrode 7 are electrically connected and sequentially arranged on the polished face surface of the substrate 1 made of stainless steel and with rounded edges.

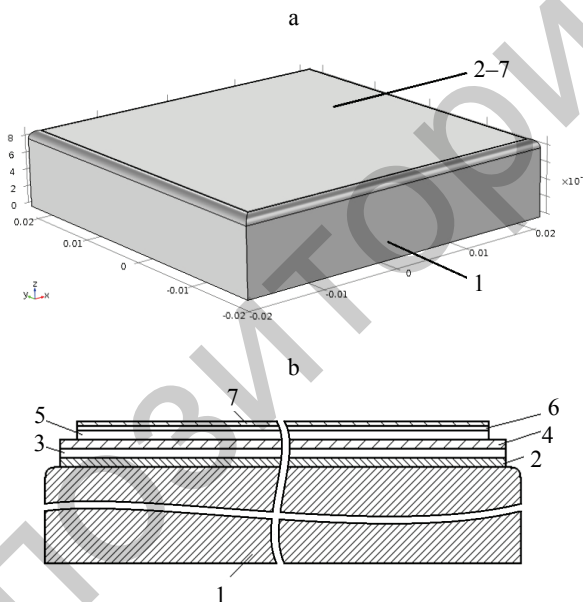

Fig. 1. The thin-film solar cell structure (a) and its cross-section (b): 1 – substrate;
2 – first electrode layer; 3 – thermoelectric layer based on CuInSe_2 ; 4 – second electrode layer;
5, 6 – photoelectric converter consisting of CuInSe_2 and CdS layers respectively;
7 – transparent electrode

Operation algorithm of the thin-film solar cell

The material of the transparent electrode 7 is zinc oxide with a band gap of 3.3 eV and a visible light transmittance of more than 80 %. This electrode passes input solar radiation, the visible part of which is absorbed in the layers 5 and 6 of the photoelectric converter that generates electric charges. The infrared part

of input solar radiation heats the layers 5 and 6 of the photoelectric converter. One fraction of the charges generated in the layer 5 is separated by the electric field of the $p-n$ junction of the photoelectric converter, which generates photo-electromotive-force (photo-emf) between the transparent electrode 7 and the second electrode layer 4. The remaining fraction of the photogenerated charges recombine and thereby contribute to the heating of the photoelectric converter. Therefore, a temperature gradient is generated between the first 2 and the second 4 electrode layers. This gradient induces thermo-electromotive-force (thermo-emf) between the upper and lower sides of the thermoelectric layer 3. As a result of this, the solar cell output voltage consisting of photo- and thermo-emf between the first electrode layer 2, electrically connected to the lower side of the thermoelectric layer 3, and the transparent electrode 7 is produced. Since the solar cell efficiency depends on the temperature, it is necessary to stabilize the photoelectric converter temperature, maintaining its efficiency at a constant level.

Computer simulation

Computer-aided design is an essential tool for construction of modern technical facilities. This is due to several factors. It makes it possible to significantly reduce the financial costs of developing the hardware components of photovoltaic devices and moreover to optimize the production processes in order to reduce the energy and resource intensity of output products, to improve its consumer qualities, and ultimately to increase its competitiveness.

The simulation was carried out using the COMSOL Multiphysics software package, which served to solve most scientific and engineering problems (starting from the geometric parameters definition and the physics description and ending with the visualization and preservation of the results) based on the system of nonlinear partial differential equations by the finite element method. The Heat Transfer Module of this software package was used to quantify the increase in the power produced by the proposed thin-film solar cell based on CuInSe_2 . This module is a specialized tool for modeling thermal processes in electronics components and power engineering, which include solar cells working under real operating conditions. Predefined settings are available for solar and ambient radiation, where the surface absorptivity for short wavelengths (the solar spectral band) may differ from the surface emissivity for the longer wavelengths (the ambient spectral band). Further, the sun radiation direction can be easily defined from the geographical position and time. The view factors are computed by using the hemicube or direct integration area method. For computationally effective simulations, it is possible to define planes or sectors of symmetry [13].

In the developed numerical three-dimensional model of a thin-film solar cell, the various conditions of its operation were considered in the presence and absence of the thermal insulation of the substrate ends as well as in the presence and absence of the temperature stabilization of the substrate back side.

The calculations were carried out taking into account the diurnal and seasonal variations of both the ambient temperature and the power density of the AM1.5 solar spectrum for the geographical coordinates of Minsk (fig. 2). The maximum value of the solar radiation power density was equal to 500 kW/m² [14] by using concentrators [15]. In climatology, the diurnal variation of the ambient temperature is averaged over many years, moreover, non-periodic temperature changes offset each other and the ambient temperature follows a simple 24 hour periodic sinusoidal distribution around an average temperature [16]:

$$T_{amb}(t) = T_{avg} + \Delta T \cos\left(2\pi \frac{t-14}{24}\right).$$

Here T_{avg} and ΔT are two customizable parameters corresponding to the average temperature and half diurnal temperature variation, respectively. The time variable t is expressed in hours. In the simulation we used above-mentioned function and average minimum ($T_{avg} - \Delta T$) and average maximum ($T_{avg} + \Delta T$) monthly ambient temperatures data in Minsk from the site: <http://belmeteo.net>. The substrate temperature was set taking into account both the change in the ambient temperature and the stabilization at 1 and 10 °C.

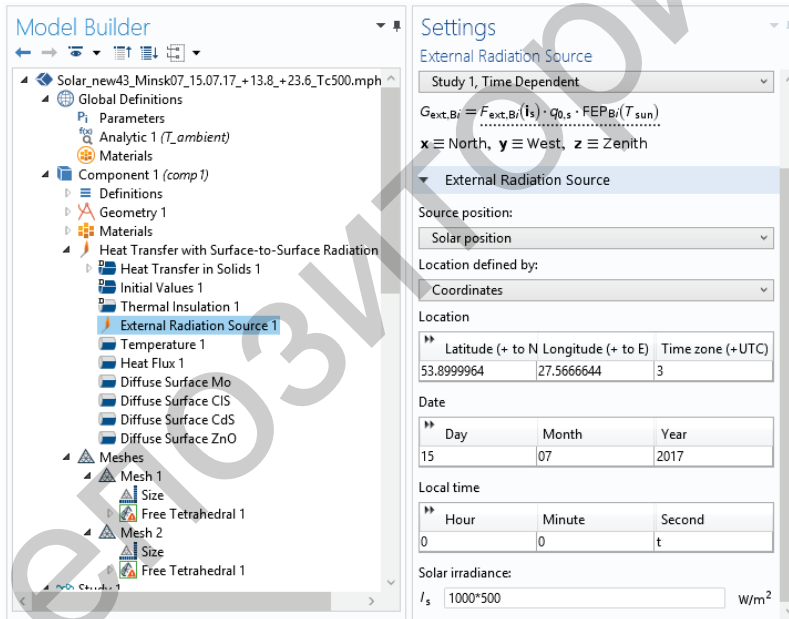

Fig. 2. Screenshot of the setting window in the COMSOL Multiphysics when defining an external radiation source using the Solar Position option

The thin-film solar cell was divided into finite tetrahedral elements in the simulation (fig. 3). At calculations, the grid density for each layer of the solar cell was adjusted taking into account its geometrical configuration by selecting one of nine preset modes: from extremely fine to extremely rough. If it is ne-

cessary to use a finer grid in any area, for example for 50 nm thick layers 6 and 7, the partition operation was performed manually. The problem solving was carried out taking into account the change in the ambient temperature. The program facilities made it possible to visualize and process calculated numerical data for all the concerned operating regimes of the thin-film solar cell.

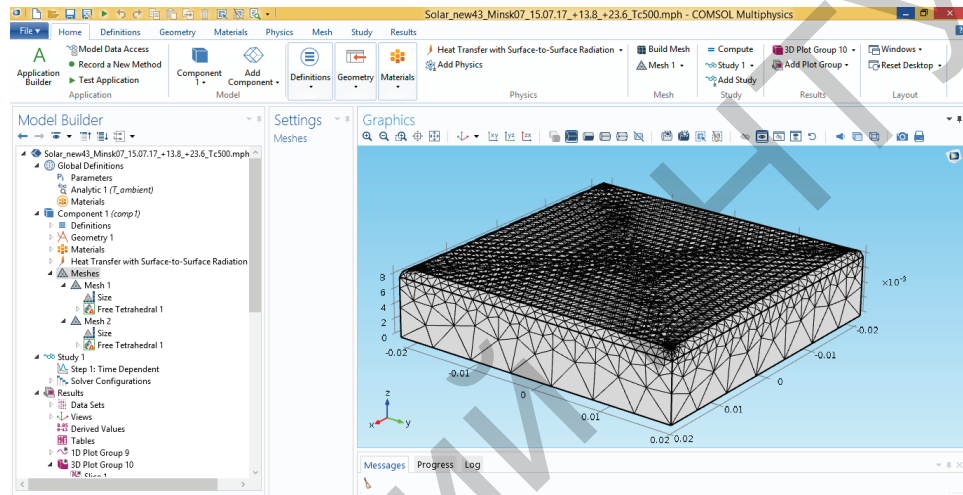

Fig. 3. Screenshot of the mesh operation of the thin-film solar cell in the COMSOL Multiphysics

Analysis of the results

As calculations have shown, the uneven heating of both the surface of a thin-film solar cell and its layers occur under conditions of diurnal and seasonal variations of both the ambient temperature and the solar radiation power density. Under the above conditions, the surface of a proposed CuInSe_2 thin-film solar cell without both its cooling and thermal insulation of the substrate ends can be heated up to the temperature (T_S) of about 700 °C (fig. 4a), which leads to permanently damages. The temperature stabilization of the substrate back side at the ambient (air) temperature ($T_0 = T_{amb}$) makes it possible to reduce the surface temperature of CuInSe_2 solar cell up to $T_S \approx 55$ °C (fig. 4b). When the temperature of the substrate back side is stabilized ($T_0 = 10$ °C), the temperature (T_S) on the surface of CuInSe_2 solar cell reaches a maximum value of about 44 °C (fig. 4c). By thermal insulation of the substrate ends and temperature stabilization of the substrate back side at $T_0 = 10$ °C, it was possible to reduce the surface temperature of CuInSe_2 thin-film solar cell up to values $T_S \approx 14.2$ °C (fig. 4d). Precisely for these boundary conditions, temperature gradients were calculated at the lower boundary of the thermoelectric layer as a function of the time of day (fig. 5). As can be seen from the graph, the temperature gradient reaches its maximum value of about $1.7 \cdot 10^5$ K/m at this boundary on the southeast side at about 12.30 hours (curve 1, fig. 5) first and then on the southwest side at about 14 hours (curve 2, fig. 5). The temperature gradients on the northeast and northwest at the given boundary are lower and equal to $1.5 \cdot 10^5$ K/m (curves 3 and 4, fig. 5).

Therefore, it is appropriate to present the results of calculations only for the southeast side of the solar cell, since there the temperature gradient has a maximum value. The thickness increase of CuInSe₂ layers to 3 μm leads only to a slight decrease of the temperature gradient to about $1.65 \cdot 10^5$ K/m at the boundary of the first electrode layer / thermoelectric layer.

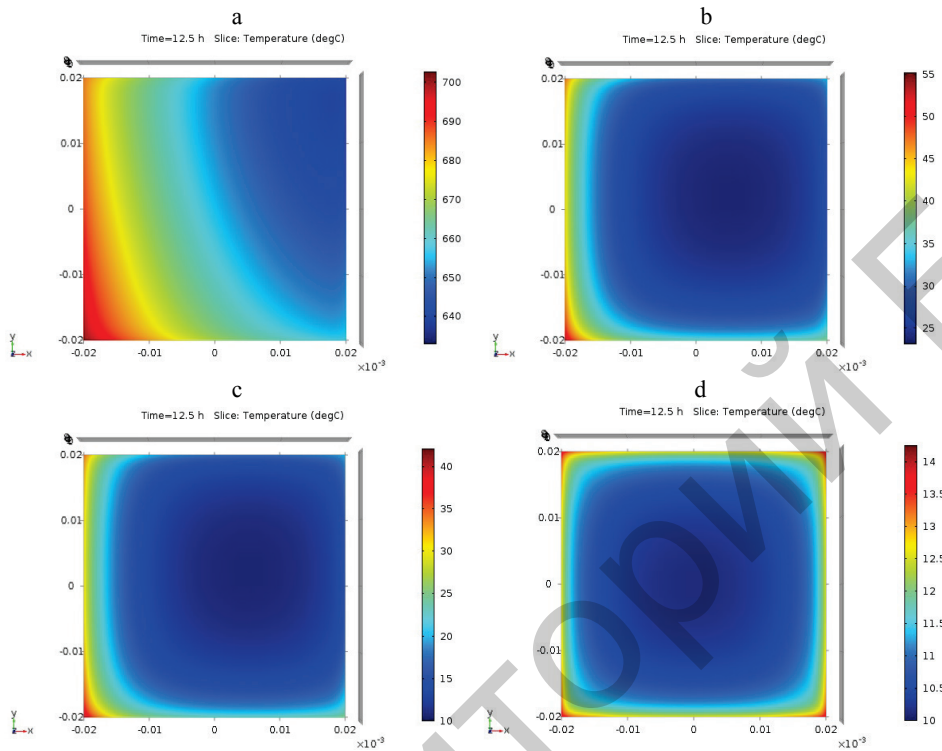

Fig. 4. The surface temperature pattern of CuInSe₂ thin-film solar cell without (a) and with ($T_0 = T_{amb}$ (b) and $T_0 = 10^\circ\text{C}$ (c, d) the temperature stabilization of the substrate back side as well as without (a, b, c) and with (d) the thermal insulation of the substrate ends at 12.30 hours in the middle of July

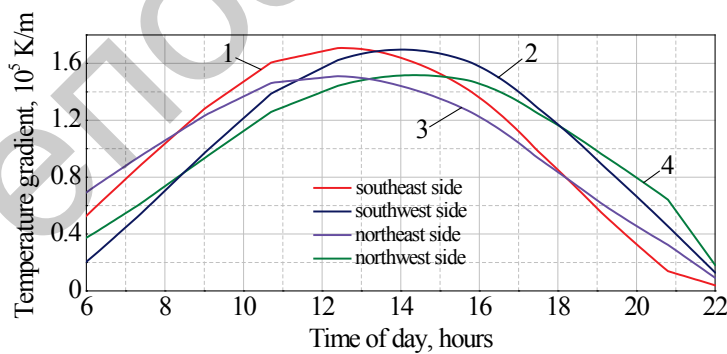

Fig. 5. The temperature gradients of CuInSe₂ solar cell at the lower boundary of the thermoelectric layer on the southeast (curve 1), southwest (curve 2), northeast (curve 3) and northwest (curve 4) sides in July

According to the calculations, the temperature gradient of the thermoelectric layer varies within a year from about $1.7 \cdot 10^5$ to about $0.5 \cdot 10^5$ K/m (fig. 6).

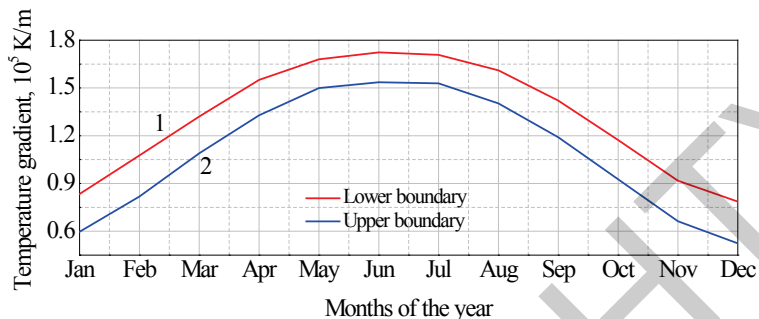

Fig. 6. The temperature gradients of CuInSe₂ solar cell with the thermal insulation of the substrate ends at the lower (curve 1) and upper (curve 2) boundaries of the thermoelectric layer on the southeast side during the year

Fig. 7 shows the daily changes of the temperature gradients at the upper and lower boundaries of the thermoelectric layer, i.e. between the first and second electrode layers, which cause the generation of thermo-emf.

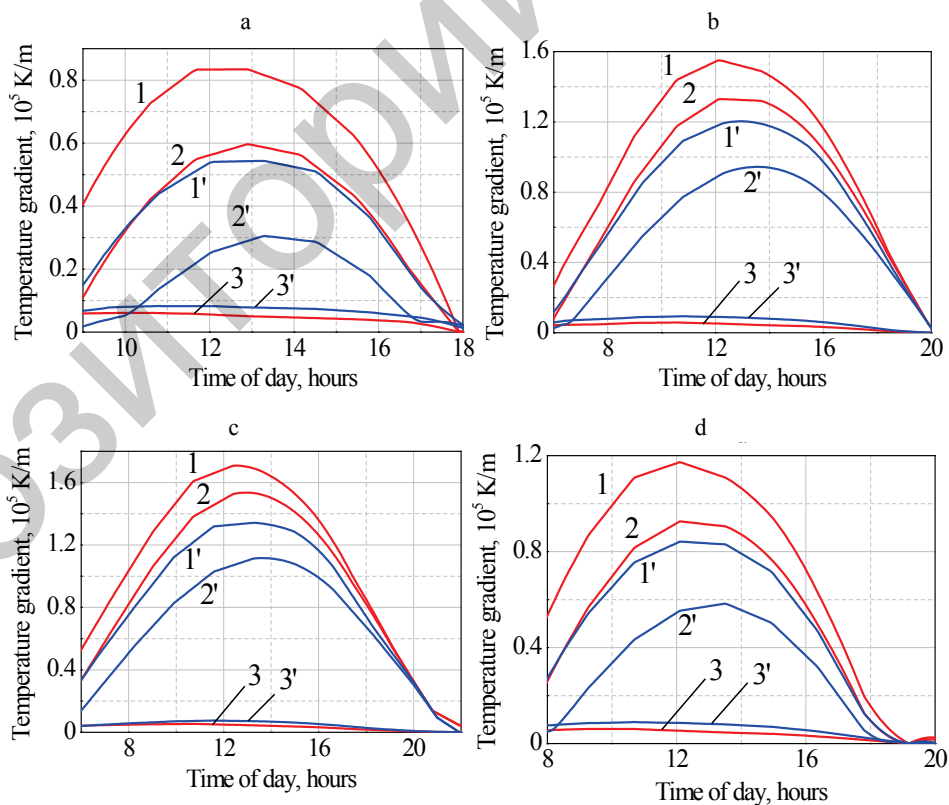

Fig. 7. The temperature gradients of CuInSe₂ solar cell at the upper (curves 1, 1') and lower (curves 2, 2') boundaries of the thermoelectric layer and at the upper (curves 3, 3') boundary of the photoelectric converter on the southeast side in the presence (curves 1, 2, 3) and the absence (curves 1', 2', 3') of the thermal insulation of the substrate ends in January (a), April (b), July (c) and October (d)

As can be seen from these graphs, the temperature gradient has a maximum value at the lower boundary of the thermoelectric layer based on CuInSe₂ (curves 1, fig. 7) irrespective of the time of year, as well as the ambient air temperature and the upper surface temperature of the transparent electrode. For example in July, when the average minimum and average maximum air temperatures can be 13.8 °C and 23.6 °C respectively, and the temperature of the substrate back side is stabilized at the level of 10 °C, the temperature gradient has a maximum value of $1.34 \cdot 10^5$ K/m (fig. 7c) at the lower boundary of the thermoelectric layer based on CuInSe₂ and in the absence of thermal insulation of the substrate ends. The temperature of the photoelectric converter in this case is equal to 44.35 °C (fig. 8c). Due to the temperature stabilization of the substrate back side and the thermal insulation of the substrate ends, it is possible to optimize the photoelectric converter operating temperature, which cannot exceed: 2.35 °C in January (fig. 8a), 13.59 °C in April (fig. 8b), 14.23 °C in July (fig. 8c) and 12.31 °C in October (fig. 8d).

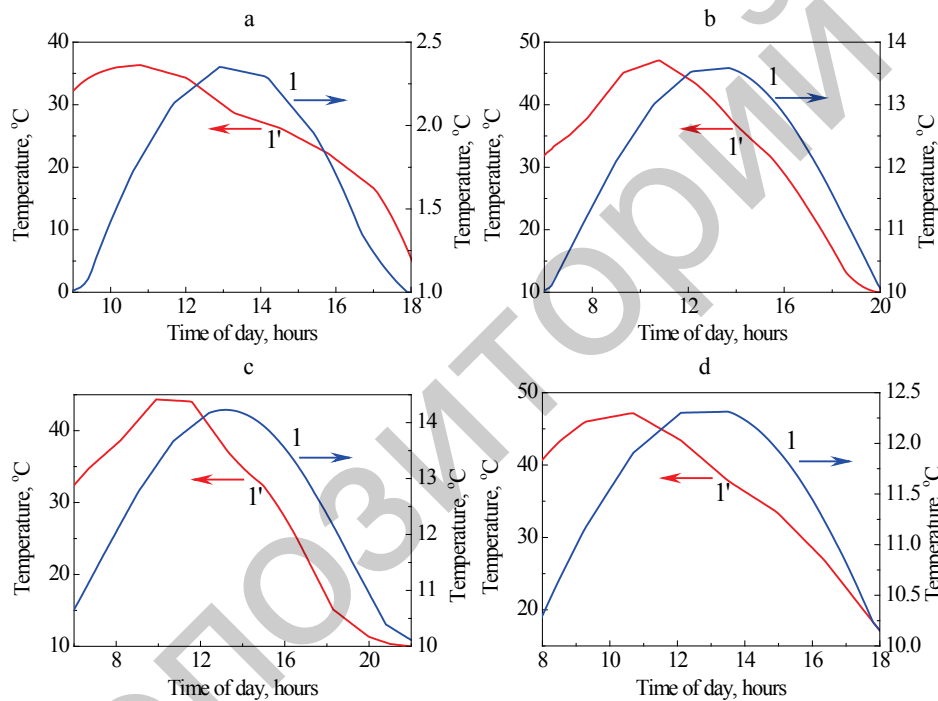

Fig. 8. The temperature of CuInSe₂ solar cell at the upper boundary of the photoelectric converter on the southeast side in the presence (curve 1) and the absence (curve 1') of the thermal insulation of the substrate ends in January (a), April (b), July (c) and October (d)

CONCLUSION

The performed simulation shows that the amplitude of the output voltage which generated by the thermoelectric layer of CuInSe₂ thin-film solar cell varies from 2.1 mV (in December) to 5.23 mV (in June and July). This means

that by selecting an operating point on the current-voltage characteristic of the proposed solar cell and by using a thermoelectric layer, its output power can be increased up to 5 %. Moreover, a more significant increase in the output power of the concerned solar cell can be achieved even by means of substrate temperature stabilization and the presence of a solar concentrator. It should be noted that the cooling inertia of a thin-film solar cell stabilizes the output voltage in some degree under partly cloudy conditions.

REFERENCES

1. Novikov G. F., Gapanovich M. V. (2017) Third Generation Cu-In-Ga-(S, Se)-Based Solar Inverters. *Physics-Uspekhi*, 60 (2), 161–178. <https://doi.org/10.3367/ufne.2016.06.037827>.
2. Haloui H., Touafek K., Zaabat M., Ben Cheikh el Hocine B., Khelifa A. (2015) The Copper Indium Selenium (CuInSe₂) Thin-Films Solar Cells for Hybrid Photovoltaic Thermal Collectors (PVT). *Energy Procedia*, 74, 1213–1219. <https://doi.org/10.1016/j.egypro.2015.07.765>.
3. Mahdjoub A., Remache L., Moualkia H., Bordji B., Hafid A. (2015) Easily Realizable Heterojunction CdS/CuInSe₂ for Thin Films Photovoltaic Application. *Chalcogenide Letters*, 12 (2), 59–66.
4. Dottermusch S., Quintilla A., Gomard G., Roslizar A., Voggu V. R., Simonsen B. A., Park J. S., Pernik D. R., Korgel B. A., Paetzold U. W., Richards B. S. (2017) Infiltrated Photonic Crystals for Light-Trapping in CuInSe₂ Nanocrystal-Based Solar Cells. *Optics Express*, 25 (12), A502–A514. <https://doi.org/10.1364/oe.25.00a502>.
5. Sadewasser S., Salome P. M. P., Rodriguez-Alvarez H. (2017) Materials Efficient Deposition and Heat Management of CuInSe₂ Micro-Concentrator Solar Cells. *Solar Energy Materials and Solar Cells*, 159, 496–502. <https://doi.org/10.1016/j.solmat.2016.09.041>.
6. Voggu V. R., Sham J., Preffer S., Pate J., Phillip L., Harvey T. B., Brown R. M. Jr., Korgel B. A. (2017) Flexible CuInSe₂ Nanocrystal Solar Cells on Paper. *ACS Energy Letters*, 2 (3), 574–581. <https://doi.org/10.1021/acseenergylett.7b00001>.
7. Davis M. W., Fannee A. H., Dougherty B. P. (2001) Prediction of Building Integrated Photovoltaic Cell Temperatures. *Journal of Solar Energy Engineering*, 123 (2), 200–210. <https://doi.org/10.1115/1.1385825>.
8. Esman A. K., Potachits V. A., Zykov G. L. (2016) Increasing Energy Efficiency of Thin-Film Solar Cell on the Basis of CuIn_{1-x}Ga_xSe₂. *Problemy Fiziki, Matematiki i Tekhniki = Problems of Physics, Mathematics and Technics*, 1 (26), 30–33 (in Russian).
9. Esman A. K., Kuleshov V. K., Zykov G. L., Zaleski V. B., Leonova T. R. (2016) *Method for Manufacturing Thin-Film Solar Cell*: Patent of the Republic of Belarus No 20481 (in Russian).
10. Patel Ch., Shah P., Pandey A. I. (2017) Performance Improvement of Solar PV Cells using Various Cooling Methods: a Review. *International Journal on Recent Trends in Computing and Communication*, 5 (11), 194–198.
11. Esman A. K., Zykov G. L., Kuleshov V. K., Potachits V. A. (2017) Generated Electric Power Increase by a Thin Film Solar Cell Based on CuInSe₂. *Innovatsionnyye Tekhnologii Obucheniya Fiziko-Matematicheskim i Professional'no-Tekhnicheskim Disttsiplinam: Materialy IX Mezhdunarodnoy Nauchno-Prakticheskoy Internet-Konferentsii [Innovative Teaching Techniques in Physics, Mathematics, Vocational and Mechanical Training: Materials of the IX International Online Research-to-Practice Conference]*. Mozyr, Mozyr State Pedagogical University Named after I. P. Shamyakin, 138–139 (in Russian).
12. Esman A. K., Potachits V. A., Zykov G. L. (2017) High-Efficiency Thin-Film Solar Cell. *Priborostroyeniye-2017: Materialy X Mezhdunarodnoy Nauchno-Tekhnicheskoy Konferentsii [Instrument Making Engineering-2017: Materials of the X International Scientific and Technical Conference]*. Minsk, Belarusian National Technical University, 364–366 (in Russian).
13. *Analyze Thermal Effects with the Heat Transfer Module*. Available at: <https://www.comsol.com/heat-transfer-module> (Accessed: 15 May 2018).

14. Alferov Zh. I., Andreev V. M., Rummyantsev V. D. (2004) Solar Photovoltaics: Trends and Prospects. *Semiconductors*, 38 (8), 899–908. <https://doi.org/10.1134/1.1787110>.
15. Khamooshi M., Salati H., Egelioglu F., Hooshyar Faghiri A., Tarabishi J., Babadi S. (2014) A Review of Solar Photovoltaic Concentrators. *International Journal of Photoenergy*, 2014, 958521-1–17. <https://doi.org/10.1155/2014/958521>.
16. Parasol and Solar Irradiation. Created in COMSOL Multiphysics 5.3a. Available at: https://www.comsol.com/model/download/466231/applications.parasol_and_solar_irradiation.pdf (Accessed: 15 May 2018).

Received: 19 March 2018

Accepted: 25 May 2018

Published online: 28 September 2018

ЛИТЕРАТУРА

1. Новиков, Г. Ф. Солнечные преобразователи третьего поколения на основе Cu-In-Ga-(S, Se) / Г. Ф. Новиков, М. В. Гапанович // Успехи физических наук. 2017. Т. 187, № 2. С. 173–191.
2. The Copper Indium Selenium (CuInSe₂) Thin-Films Solar Cells for Hybrid Photovoltaic Thermal Collectors (PVT) / H. Haloui [et al.] // Energy Procedia. 2015. Vol. 74. P. 1213–1219.
3. Easily Realizable Heterojunction CdS/CuInSe₂ Thin-Films Photovoltaic Application / A. Mandjoub [et al.] // Chalcogenide Letters. 2015. Vol. 12, No 2. P. 59–66.
4. Infiltrated Photonic Crystals for Light-Trapping in CuInSe₂ Nanocrystal-Based Solar Cells / S. Dottermusch [et al.] // Optics Express. 2017. Vol. 25, No 12. P. A502–A514.
5. Sadewasser, S. Materials Efficient Deposition and Heat Management of CuInSe₂ Micro-Concentrator Solar Cells / S. Sadewasser, P. M. P. Salome, H. Rodriguez-Alvarez // Solar Energy Materials and Solar Cells. 2017. Vol. 159. P. 496–502.
6. Flexible CuInSe₂ Nanocrystal Solar Cells on Paper / V. R. Voggu [et al.] // ACS Energy Lett. 2017. Vol. 2, No 3. P. 574–581.
7. Davis, M. W. Prediction of Building Integrated Photovoltaic Cell Temperatures / M. W. Davis, A. H. Fanney, B. P. Dougherty // J. Sol. Energy Eng. 2001. Vol. 123, No 2. P. 200–210.
8. Есман, А. К. Повышение энергоэффективности тонкопленочных солнечных элементов на основе соединения CuIn_{1-x}Ga_xSe₂ / А. К. Есман, В. А. Потачиц, Г. Л. Зыков // Проблемы физики, математики и техники. 2016. Т. 1, № 26. С. 30–33.
9. Способ изготовления тонкопленочного солнечного элемента: пат. 20481 Респ. Беларусь: МПК Н 01L 31/18, Н 01L 31/0264 / А. К. Есман, В. К. Кулешов, Г. Л. Зыков [и др.]; дата публ. 30.10.2016.
10. Patel, Ch. Performance Improvement of Solar PV Cells Using Various Cooling Methods: a Review / Ch. Patel, P. Shah, A. I. Pandey // International Journal on Recent Trends in Computing and Communication. 2017. Vol. 5, Iss. 11. P. 194–198.
11. Повышение вырабатываемой электроэнергии тонкопленочным солнечным элементом на основе CuInSe₂ / А. К. Есман [и др.] // Инновационные технологии обучения физико-математическим и профессионально-техническим дисциплинам: материалы IX Междунар. науч.-практ. интернет-конф., Мозырь, 21–24 марта 2017 г. / УО МГПУ имени И. П. Шамякина; редкол.: И. Н. Ковальчук (отв. ред.) [и др.]. Мозырь, 2017. С. 138–139.
12. Есман, А. К. Высокоэффективный тонкопленочный солнечный элемент / А. К. Есман, В. А. Потачиц, Г. Л. Зыков // Приборостроение-2017: материалы X Междунар. науч.-техн. конф., 1–3 нояб. 2017 г., Минск / Белорусский национальный технический университет; редкол.: О. К. Гусев [и др.]. Минск: БНТУ, 2017. С. 364–366.
13. Analyze Thermal Effects with the Heat Transfer Module. USA, COMSOL, Inc. Режим доступа: <https://www.comsol.com/heat-transfer-module>. Дата доступа: 19.03.2018.
14. Алферов, Ж. И. Тенденции и перспективы развития солнечной фотоэнергетики / Ж. И. Алферов, В. М. Андреев, В. Д. Румянцев // Физика и техника полупроводников. 2004. Т. 38, вып. 8. С. 937–948.
15. A Review of Solar Photovoltaic Concentrators / M. Khamooshi [et al.] // International Journal of Photoenergy. 2014. Vol. 2014. P. 958521-1–17.
16. Parasol and Solar Irradiation. Created in COMSOL Multiphysics 5.3a. USA, COMSOL, Inc. Режим доступа: https://www.comsol.com/model/download/466231/applications.parasol_and_solar_irradiation.pdf. Дата доступа: 19.03.2018.

Поступила 19.03.2018

Подписана в печать 25.05.2018

Опубликована онлайн 28.09.2018