

**Белорусский национальный технический университет**  
Факультет горного дела и инженерной экологии  
Кафедра «Английский язык № 1»

СОГЛАСОВАНО

Заведующий кафедрой

\_\_\_\_\_ С.А. Хоменко

«\_\_\_» \_\_\_\_\_ 2013 г.

СОГЛАСОВАНО

Декан факультета

\_\_\_\_\_ П.В. Цыбуленко

«\_\_\_» \_\_\_\_\_ 2013 г.

**ЭЛЕКТРОННЫЙ УЧЕБНО-МЕТОДИЧЕСКИЙ КОМПЛЕКС ПО  
УЧЕБНЫМ ДИСЦИПЛИНАМ**

**ИНОСТРАННЫЙ ЯЗЫК (АНГЛИЙСКИЙ)  
СПЕЦКУРС ИНОСТРАННОГО ЯЗЫКА (АНГЛИЙСКИЙ ЯЗЫК)**

для студентов специальности  
1-44 01 01 Организация перевозок и управление на автомобильном и  
городском транспорте

Составители: Хоменко С.А., Боярская А.О., Личевская С.П., Ваник И.Ю.

Рассмотрено и утверждено

на заседании Совета факультета горного дела и инженерной экологии

«\_\_\_» \_\_\_\_\_ 2013 г., протокол № \_\_\_\_\_

**Перечень материалов:** Электронный учебно-методический комплекс содержит материалы для теоретического изучения дисциплин, пакет учебных пособий по изучаемым дисциплинам, примерные планы-конспекты практических занятий по дисциплинам, комплект тестов для промежуточного и итогового контроля знаний, учебно-программную документацию, состоящую из базовой и рабочей учебных программ, учебно-методическую документацию, которая включает методические рекомендации по дисциплинам для преподавателей, методические рекомендации по обучению профессионально ориентированной устной речи, методические рекомендации по изучению дисциплин для студентов. Электронный учебно-методический комплекс предназначен для студентов и преподавателей.

**Рецензенты:** Кафедра английского языка экономических специальностей Белорусского государственного университета;

Е.З. Шевалдышева, кандидат филологических наук, доцент кафедры английского языка естественных факультетов Белорусского государственного университета

## Пояснительная записка

Расширение международного сотрудничества в экономической, научно-технической и образовательной областях требует от современного выпускника высшей школы активного владения иностранным языком, которое позволяет реализовать такие аспекты профессиональной деятельности, как своевременное ознакомление с новейшими технологиями, открытиями и тенденциями в развитии науки и техники, установление профессиональных контактов с зарубежными партнерами и повышение уровня профессиональной компетентности.

Данный электронный учебно-методический комплекс (ЭУМК) разработан для студентов автотракторного факультета для специальности 1-44 01 01 Организация перевозок и управление на автомобильном и городском транспорте. Такой комплекс является одним из вариантов нового поколения учебных материалов по дисциплинам «Иностранный язык (английский)» и «Спецкурс иностранного языка (английский язык)» для данной специальности.

Представленный ЭУМК содержит учебно-программную документацию, пакет учебных пособий по изучаемым дисциплинам, примерный план-конспект практического занятия по дисциплинам, полный комплект тестов для промежуточного и итогового контроля, методические рекомендации по дисциплинам для преподавателей, методические рекомендации по дисциплинам для студентов, методические рекомендации по организации самостоятельной работы студентов, методические рекомендации по подготовке презентаций.

Основной **целью** данного ЭУМК является формирование у студентов указанной специальности навыков и развитие умений профессионально-ориентированного иноязычного общения в устной и письменной форме в предполагаемых ситуациях социокультурной и профессиональной деятельности, а также в ознакомлении с зарубежным опытом в соответствующей области знания.

Весь курс обучения разделен на две дисциплины: базовый курс «Иностранный язык (английский)», рассчитанный на 136 часов аудиторных занятий в 1-4 семестрах, и «Спецкурс иностранного языка (английский язык)», предусматривающий 172 часа аудиторных занятий в 1, 2 и 7 учебных семестрах.

Изучение дисциплин «Иностранный язык (английский)» и «Спецкурс иностранного языка (английский язык)» предусматривается учебным планом подготовки студентов автотракторного факультета БНТУ по специальности «1-44 01 01 Организация перевозок и управление на автомобильном и городском транспорте» и является обязательным в цикле общепрофессиональных и специальных дисциплин.

Иностранный язык в техническом университете как ни какой другой предмет имеет тесную связь со множеством дисциплин естественнонаучного

цикла («Математика», «Физика», «Химия», «Информатика», «Основы экологии» и т.д.). Он также связан с рядом специальных дисциплин, преподаваемых студентам вышеуказанной специальности, таких как: «Внешнеэкономическая деятельность», «Таможенные и визовые системы», «Логистика», «Автомобильные перевозки грузов и пассажиров», «Транспортная экология», «Информационные системы на транспорте» и др. Это обеспечивает практическую направленность в системе обучения и соответствующий уровень использования иностранного языка в будущей профессиональной деятельности. Например, на занятиях по английскому языку студенты специальности «Организация перевозок и управление на автомобильном и городском транспорте» изучают принципы составления международных контрактов, деловой корреспонденции и толкование международных терминов, принятых в странах ЕС. Составление терминологического словаря по специальности облегчает будущим специалистам по международным перевозкам чтение специальной технической литературы на иностранном языке, заполнение накладных и работу с документацией.

Поэтому основной целью изучения иностранного языка является формирование иноязычной коммуникативной компетентности будущего специалиста, позволяющей использовать иностранный язык как средство профессионального и межличностного общения в ситуациях производственной и социокультурной деятельности.

Задачи обучения можно сформулировать следующим образом:

- переориентировать студентов в психологическом плане и практически с понимания иностранного языка лишь как внешнего источника информации и иноязычного средства коммуникации на усвоение и использование иностранного языка для выражения собственных высказываний и понимания других людей;
- подготовить студентов к естественной коммуникации в устной и письменной формах иноязычного общения;
- научить студентов видеть в иностранном языке средство получения, расширения и углубления системных знаний по специальности и средство самостоятельного повышения своей профессиональной квалификации.

## Содержание

### 1. Теоретический раздел

#### 1.1 Материалы для теоретического изучения

### 2. Практический раздел

#### 2.1 Учебные пособия для проведения практических занятий

#### 2.2 План-конспект практического занятия по английскому языку для студентов I курса АТФ к пособию Basic English for Technical Students

#### 2.3 План - конспект практического занятия по английскому языку с использованием технологии «Обучение в сотрудничестве» к пособию Basic English for Technical Students

#### 2.4 План - конспект практического занятия по английскому языку к пособию Spoken English for Transportation

### 3. Раздел контроля знаний

#### 3.1 Ситуации для промежуточного и итогового контроля навыков и умений устной речи

#### 3.2 Тесты к пособию Basic English for Technical Students

#### 3.3 Тесты к пособию English for Transportation

#### 3.4 Тесты к пособию Spoken English for Transportation

#### 3.5 Тесты к пособию Transport Business Documentation

#### 3.6 Тесты к пособию по переводу

### 4. Вспомогательный раздел

#### 4.1 Учебно-программная документация

##### 4.1.1 Учебная программа по дисциплине «Иностранный язык (английский)» (рабочий вариант).

##### 4.1.2 Базовая учебная программа по дисциплине «Спецкурс иностранного языка (английский язык)».

#### 4.2 Учебно-методическая документация

##### 4.2.1 Методические рекомендации по изучению дисциплин «Иностранный язык (английский)» и «Спецкурс иностранного языка (английский язык)» для преподавателей

##### 4.2.2 Методические рекомендации по обучению профессионально ориентированной устной речи

##### 4.2.3 Методические рекомендации по изучению дисциплин «Иностранный язык (английский)» и «Спецкурс иностранного языка (английский язык)» для студентов

## 1. Теоретический раздел

### 1.1 Материалы для теоретического изучения

Кипнис, И.Ю. Грамматические особенности перевода английского научно-технического текста / И.Ю. Кипнис, С.А. Хоменко. – Минск: БНТУ, 2010. – 121 с.

## 2. Практический раздел

### 2.1 Учебные пособия для проведения практических занятий

1. Английский язык для студентов технических вузов: основной курс. Basic English for Technical Students / С.А. Хоменко [и др.]; под общ. ред. С.А. Хоменко, В.Ф. Скалабан. – Минск: Вышэйшая школа, 2004. В 2 ч. – 494 с.
2. Методическое пособие по обучению устной речи студентов технических вузов / И. Ю. Ваник [и др.]. – Минск: БНТУ, 2012. – 65 с.
3. Боярская, А.О. Пособие по практическому курсу научно-технического перевода для студентов технических специальностей автотракторного факультета / А.О.Боярская, С.Д. Симонова, Е.В. Слесаренок. – Минск, 2006. – 104 с.
4. Боярская, А.О. English for Transportation. Пособие по английскому языку для специалистов по организации перевозок / А.О. Боярская, Л.В. Педько, Е.В. Слесаренок. – Минск, 2009. – 111 с.
5. Боярская, А.О. Transport Business Documentation: пособие / А.О. Боярская, Л.В. Педько, Е.В. Слесаренок. – Минск, 2011. – 110 с.
6. Боярская, А.О. Spoken English for Transportation: пособие / А.О. Боярская, Н.Ф. Ладутько, Т.Е. Митьковец.– БНТУ, 2012. – 78 с.

### 2.2 План-конспект практического занятия по английскому языку для студентов I курса АТФ к пособию Basic English for Technical Students, Part I

**Тема:** Motor Vehicles

**Речевые функции:** выражение своей точки зрения, ответы на вопросы

**Образовательная цель:** формирование знаний о типах транспортных средств и типах двигателей, формирование лексических навыков; употребление конструкции there is/are

**Воспитательная цель:** повышение престижа белорусской автомобильной промышленности

**Развивающая цель:** развитие внимания, памяти, воображения, логического мышления, умения работать в команде

**Сопутствующие задачи:** совершенствование навыков монологической и диалогической речи

**Лексический материал:** engineering, petrol, engine, vehicle, injector, valve, fuel, spark plug, spare parts

**Грамматический материал:** конструкция there is/are

**Оснащение:** Basic English for Technical Students. Ч.1, Хоменко С.А., Скалабан В.Ф. и др., Минск 2004, раздаточный материал.

Этап	Задача этапа	Преподаватель	Студенты	Время
Начало занятия	Введение в атмосферу иноязычного общения	Good morning, students! How are you today? How did you spend your weekend?	Студенты отвечают на заданные вопросы	2 мин
		Thank you. At home you had to read the dialogue on page 44 and define the meaning of the words in bold. I'll distribute you some cards. Work in pairs. One of you reads the definition, the other names the word and then vice versa (см. приложение А 1)	Студенты работают в парах, проверяя друг у друга домашнее задание	10 мин
		Now, complete the dialogue on page 45 using the expressions of certainty and uncertainty from the box	Студенты работают в парах	10 мин
Введение нового лексического и грамматического явления	Формирование знаний, лексических и грамматических умений и навыков	Well done! Now, let's learn more about other parts of motor vehicles. Open your books on page 45 and look through exercises 1, 2. Check any unknown words in active vocabulary on page 248-249. We'll check your answers in 5 minutes	При выполнении упражнения студенты выписывают активную лексику в конспект	10 мин
		Let's continue our work and pass to the new grammar material. Study the tables with the construction there is/are on page 264. Pay special	Студенты изучают и конспектируют грамматический	8 мин

Тренировка нового грамматического материала	Формирование грамматических навыков	attention to interrogative and negative forms.	материал	
		Now, let's see how this construction can be translated into Russian. Match the English sentences with their Russian equivalents (см. приложение А 2)	Студенты выполняют упражнение на карточках	5 мин
		Ok. Thank you for your work. Now You can have a break	Студенты выполняют упражнения по модели	5 мин
		Let's pass to exercises 3, 4 on page 46. You are to change the structure of the sentences using the model	Студенты работают в парах	10 мин
		Look at exercise 5 on page 47 and make up short dialogues following the model	Студенты читают текст и обсуждают информацию в мини группах,	5 мин
		Now, let's pass to page 48 and read the text to learn more about different types of engines	отвечая на вопросы после текста (упр.2 стр.49) После обсуждения они выходят к доске и	15 мин



		Now, let's discuss the information that you have learnt from the text	делают презентацию, используя подстановочную таблицу упр.3 стр.49	12 мин
Завершающий этап	Объяснение домашнего задания, рефлексия	Thank you for your participation. You've worked very productively today. Have you enjoyed the class? What new information have you learnt? And now write down your home assignment for the next class: ex. 7 p. 47, ex. 8 p. 48 You are to find mistakes in the sentences and correct them. In the next exercise you are to translate the sentences from Russian into English using active vocabulary OK. Our time is up. The class is over.	Студенты записывают домашнее задание	3 мин

## Приложение А 1

### The definitions of the active words

1. a vehicle with four wheels and an engine, that can carry a small number of passengers (a car)
2. a fast two-wheeled vehicle with an engine (a motorcycle)
3. the part of a vehicle that produces power to make it move (an engine)
4. a machine with an engine that is used to take people or things from one place to another (a vehicle)
5. the part of a car or aircraft which stops the engine from getting too hot (a radiator)
6. a way in which two or more people or things are not like each other (difference)

**Match the English sentences with their Russian equivalents**

1. There are no spark plugs in diesel engines.
2. There are 2 types of engines.
3. Is there a steering wheel in a motorcycle?
4. Are there spark plugs in all petrol engines?
5. There are water-cooled and air-cooled engines.
6. There is a spare tyre in the boot.
7. There isn't a jack under the car.

- a) Существует 2 типа двигателей.
- b) В дизельных двигателях нет свечей зажигания.
- c) Существуют двигатели с водяным и воздушным охлаждением.
- d) В багажнике находится запасная шина.
- e) Есть ли в мотоцикле рулевое колесо?
- f) Под автомобилем нет домкрата.
- g) Во всех ли бензиновых двигателях есть свечи зажигания?

**2.3 План - конспект практического занятия по английскому языку с использованием технологии «Обучение в сотрудничестве» к пособию Basic English for Technical Students, Part I, Unit 9, Robotics**

Фрагмент № 1. Формирование навыков чтения с использованием приема «*Student's team learning (обучение в команде)*»

Цель:

- ✓ *образовательная*: формирование лексических навыков, навыков чтения технических текстов у студентов, формирование навыков монологической речи.
- ✓ *воспитательная*: воспитание у учащихся умений работать сообща, в команде, развитие чувства взаимопомощи и ответственности за выполнение общего задания;
- ✓ *развивающая*: развитие психологических индивидуальных особенностей учащихся через работы в микро-группах.

*Сопутствующие задачи*: совершенствование произносительных навыков, формирование навыков восприятия речи на слух.

*Оснащение*: учебное пособие “Basic English for Technical Students” Ч.1, под редакцией С.А. Хоменко, В.Ф. Скалабан, Минск 2004.

№ п\п	Этап	Преподаватель	Студенты
1.	Введение в атмосферу	Good afternoon, students! How are things with you?	Студенты реагируют на речь преподавателя.

	иноязычного общения	Actually, have you ever heard about robots? What do you imagine when you hear this word?	
2.	Формирование навыков чтения	<p>Well, there are lots of articles written about robots. These articles give one an opportunity to learn much about the topic discussed.</p> <p>And now get divided into 3 groups. Each group receives a text about robotics. You will have to read it, in groups, make up a vocabulary list with unknown words. After reading a text you are to make a presentation of the topic you dealt with. Don't forget to prepare some questions for discussion in class. You are given 20 minutes to get prepared.</p> <p><i>Преподаватель подходит к каждой из групп, отвечает на задаваемые вопросы, помогает при возникновении трудностей.</i></p>	<p>Студенты внимательно слушают объяснение инструкций</p> <p>Студенты выполняют задание преподавателя. Каждая мини-группа читает текст. Первая мини-группа получает текст на стр. 148 упр. 2, вторая - на стр. 153 упр. 2, третья - на стр. 161 упр. 3. Участники внимательно читают тексты, составляют словари и готовят доклады по прочитанному. Также они составляют вопросы для обсуждения темы в классе.</p> <p>По истечении времени представители каждой из групп делают презентацию, после которой студенты начинают дискуссию.</p>
3.	Анализ достижений студентов. Рефлексия	Well, you have worked very productively today. Actually what have you learned from our discussion? What skills have you received?	Обучаемые рассказывают о своих впечатлениях и отвечают на вопросы преподавателя.

Фрагмент № 2. Формирование грамматических навыков употребления *Present Perfect (Active)* с использованием приема "*Learning Together (учимся вместе)*"

Цель:

- ✓ *образовательная*: формирование навыков употребления Present Perfect Active у студентов; формирование знаний о том, что одна и та же мысль в разных языках может быть выражена по-разному;
- ✓ *воспитательная*: воспитать у студентов умение работать сообща, в команде, развить чувство взаимопомощи и ответственности за выполнение общего задания;
- ✓ *развивающая*: развитие психологических индивидуальных особенностей учащихся через работы в микро-группах.

*Сопутствующие задачи*: развитие произносительных, развитие навыков восприятия речи на слух, развитие навыков монологической речи.

*Оснащение*: учебное пособие “Basic English for Technical Students” Ч.1, под редакцией С.А. Хоменко, В.Ф. Скалабан, Минск 2004., раздаточный материал, карточки-опоры.

№ п\п	Этап	Преподаватель	Студенты
1.	Введение в атмосферу иноязычного общения	Good afternoon, students! How are things with you? How is your mood today?	Студенты реагируют на речь преподавателя.
2.	Формирование навыков употребления Present Perfect Active	Well, as far as you know, there are lots of ways to express the tense form. Today we are going to deal with the Present Perfect tense form. I'll divide you into 3 groups. Each group will have to fulfill its own task. Then you will interchange with other student and present the information you dealt with to them. You are given 20 minutes to get prepared.	Студенты внимательно слушают объяснение заданий.  <i>Преподаватель делит группу на 3 мини-группы. Основной критерий-уровень обученности студентов. Так, учащиеся с низким уровнем успеваемости получают задание выяснить формы образования Present Perfect (карточка №1). Обучаемые со средним уровнем изучают случаи употребления (карточка №2). Студенты</i>

		<p><i>Преподаватель подходит к каждой из групп, отвечает на задаваемые вопросы, помогает при возникновении трудностей.</i></p>	<p><i>высокого уровня подготовки должны найти и объяснить все случаи употребления Present Perfect в данных предложениях (карточка №3).</i></p> <p>После того, как преподаватель раздал задания, группы приступают к их выполнению. По истечении выделенного времени участники группы смешиваются с другими подгруппами и начинают обсуждения правила. (Карточки-задания см. в приложении Б 1)</p>
3.	Анализ достижений студентов. Рефлексия	<p>Well, you have done a very serious research today. Now I'll distribute a special sheet of paper for you. You will have to assess progress and the progress of your partners. (Self-evaluation sheet см. в приложении Б 2)</p>	<p>Студенты заполняют self-evaluation sheets, в которых оценивают свои результаты.</p>

## Приложение Б 1

К фрагменту № 2 «Формирование грамматических навыков употребления *Present Perfect (Active)* с использованием приема “*Learning Together (учимся вместе)*”»

I. Карточка № 1. Заполните схему.

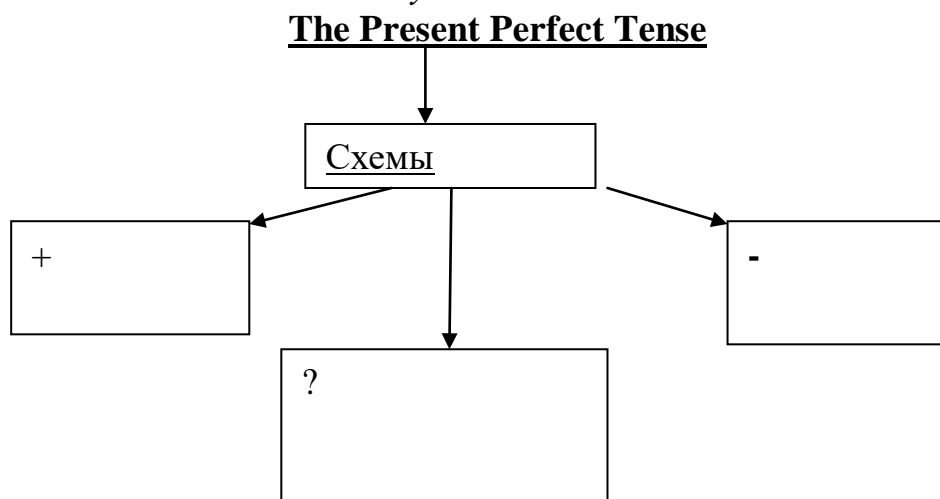

II. Карточка № 2. Выявите случаи употребления и указатели Present Perfect

The Present Perfect Tense	
Употребление	Указатели
1.	
2.	
3.	
4.	
5.	

III. Карточка №3. Найдите формы Present Perfect и проанализировать случаи его употребления в данных предложениях.

1. Andrew has been a student of this technical university for 3 years.
2. Helen has just carried out a new experiment with a robot.
3. The Professor has described achievements in robotics to his students.
4. They have invented new robot components this week.
5. The laboratory has recently received a new model of robot.

Приложение Б 2

Self-evaluation sheet к фрагменту № 2

Your Work with your Partner Processing Sheet	
1.	We did a good job together Yes_____ No_____
2.	We encouraged each other and we cooperated with each other during the discussion. Yes___ No_____
3.	We were friendly and helpful. Yes_____ No_____
4.	We eagerly shared our ideas and appreciated them. Yes_____ Not always_____ No_____
5.	We did best at_____
6.	Next time we will improve at_____
7.	We realized the advantage of working in pairs Yes_____ No _____
8.	We hope that we deserve the following mark for our activity: 10 ___ 9 ___ 8 ___ 7 ___ 6 ___ 5 ___ 4 ___ 3 ___ 2 ___ 1

## 2.4 План - конспект практического занятия по английскому языку к пособию *Spoken English for Transportation, Unit 3, Trucks and Cargoes*

- Books closed. Divide the class into groups.

Ask groups to write as many European countries as they can in three minutes.

Get groups to take turns calling out countries. Write ideas on the board. Check pronunciation.

You can make the activity competitive by awarding groups a point for any country that the other group do not have on their list.

- Ask Ss to find the countries they have already mentioned on the map in **Ex.1**. Ss continue to do **Ex. 1** individually and then compare ideas with the partner. Circulate and monitor. Check answers.

- Ask Ss to work in pairs, taking it in turns to ask and answer about the map of Europe (**Ex.2**). Help where needed.

- Say the name of three companies you think the class will know and ask Ss to say the nationalities. Elicit ideas around the class.

*Michelin – French*

*Volvo – Swedish*

*Siemens –German*

Get Ss to think of three companies each. Make sure they choose companies that they know the nationality of. Ask them to take it in turns to say the name of the company and guess what nationality it is. Help with pronunciation where needed. Spend some time comparing the word stress for countries and nationalities.

- In pairs, allow students a few minutes to identify the European vehicle signs (**Ex.3**). Check answers.
- Give Ss time to do matching **Exercise 4**, and then check answers. Encourage students to write the words in their notebooks.
- Ensure Ss understand the vocabulary from the previous exercise, then allow five minutes for them to complete the sentences in **Exercise 5**. Check answers.
- **Exercise 6**. Ask students to read the notes. Give students time to ask questions and clarify where needed.

Write the following on the board:

*If you prefer..., we could also arrange...*

*Could you tell me how much/ many/long/often... ?*

*You should also consider air transport for...*

To check Ss' understanding, discuss which of these phrases can be used to make enquiries, to offer alternatives, and to advise the customer.

- Ask Ss to read the telephone conversation (**Ex.7**) individually, and decide which underlined phrases are used to make enquiries, to offer alternatives, and to advise the customer. Clarify any unfamiliar terms and vocabulary. Get students to compare their answers in pairs.
- Choose a pair of confident Ss to read the conversation to the class. Focus on pronunciation and intonation. Divide the group into pairs and tell Ss to practise the conversation with their partner. Circulate and monitor.
- Ask students to complete **Exercise 8** using the information from **Ex.7**. Help where necessary. Check the answers around the class.
- **Exercise 9.** Check that Ss know the meaning of *perishable /non-perishable*. Go through the words in the box with the whole class, pausing to check or model the pronunciation; explain any words your Ss may have problems with. Put the first three words into the correct column with the whole group. Then Ss continue the exercise individually. Check the answers around the class. Ask Ss to decide which trucks can be used to transport these goods. Encourage Ss to discuss which of the suggestions they agree with and why.
- **Exercise 10.** Do the matching exercise together with the whole class.
- **Exercise 11.** Divide the class into pairs. Ask Ss to complete the extracts from a conversation with phrases from the previous exercise.
- Go over all the phrases and vocabulary of the unit. Tell Ss to use these phrases and vocabulary to role-play a telephone conversation (**Ex.12**). Less confident students may prefer to write notes first. Circulate, monitor and help if necessary. Then ask pairs to come to the front and act out their conversation.



### **3. Раздел контроля знаний**

**3.1 Ситуации для промежуточного и итогового контроля навыков и умений устной речи**

**3.2 Тесты к пособию Basic English for Technical Students**

**3.3 Тесты к пособию English for Transportation**

**3.4 Тесты к пособию Spoken English for Transportation**

**3.5 Тесты к пособию Transport Business Documentation**

**3.6 Тесты к пособию по переводу**

### **4. Вспомогательный раздел**

#### **4.1 Учебно-программная документация**

**4.1.1** Учебная программа по дисциплине «Иностранный язык (английский)» (рабочий вариант).

**4.1.2** Базовая учебная программа по дисциплине «Спецкурс иностранного языка (английский язык)».

#### **4.2 Учебно-методическая документация**

##### **4.2.1 Методические рекомендации по изучению дисциплин «Иностранный язык (английский)» и «Спецкурс иностранного языка (английский язык)» для преподавателей**

Студенты специальности «1-44 01 01 Организация перевозок и управление на автомобильном и городском транспорте» изучают дисциплину «Иностранный язык (английский)» в течение 1-4 семестров. Базовыми учебными пособиями по данной дисциплине являются:

1. Английский язык для студентов технических вузов: основной курс. Basic English for Technical Students / С.А. Хоменко [и др.]; под общ. ред. С.А. Хоменко, В.Ф. Скалабан. – Минск: Вышэйшая школа, 2004. В 2 ч. – 494 с.
2. Методическое пособие по обучению устной речи студентов технических вузов / И. Ю. Ваник [и др.]. – Минск: БНТУ, 2012. – 65 с.
3. Боярская, А.О. Пособие по практическому курсу научно-технического перевода для студентов технических специальностей

автотракторного факультета / А.О.Боярская, С.Д. Симонова, Е.В. Слесаренок. – Минск, 2006. – 104 с.

4. Кипнис, И.Ю. Грамматические особенности перевода английского научно-технического текста / И.Ю. Кипнис, С.А. Хоменко. – Минск: БНТУ, 2010. – 121 с.

Одновременно с базовым курсом английского языка учебным планом подготовки студентов указанной специальности предусмотрено изучение дисциплины «Спецкурс иностранного языка (английский язык)», главной целью которой является формирование навыков профессионально ориентированного общения в сфере международных автомобильных перевозок; совершенствование навыков письменного и устного перевода по специальности с английского языка на русский и с русского на английский; формирование навыков ведения деловой переписки и составления транспортной документации на иностранном языке.

Основными учебными пособиями для изучения данной дисциплины являются:

1. Боярская, А.О. English for Transportation. Пособие по английскому языку для специалистов по организации перевозок / А.О. Боярская, Л.В. Педько, Е.В. Слесаренок. – Минск, 2009. – 111 с.
2. Боярская, А.О. Transport Business Documentation: пособие / А.О. Боярская, Л.В. Педько, Е.В. Слесаренок. – Минск, 2011. – 110 с.
3. Боярская, А.О. Spoken English for Transportation: пособие / А.О. Боярская, Н.Ф. Ладутько, Т.Е. Митьковец.– БНТУ, 2012. – 78 с.

Содержание практических занятий по изучаемым дисциплинам определяется учебными календарно-производственными планами.

Изучение дисциплины «Иностранный язык (английский)» начинается с корректирующего этапа, на котором осуществляется повторение и систематизация языковых знаний, умений и навыков, приобретенных учащимися в процессе обучения в средней школе.

Основным направлением последующего обучения является достижение практических, образовательных, развивающих и воспитательных целей. При этом на протяжении всего курса обучения иностранному языку продолжается работа по усвоению языковых знаний (фонетических, лексических, грамматических и орфографических), формированию и совершенствованию языковых навыков и развитию речевых умений, а также по углублению и расширению культурологических знаний. Наряду с этим в связи с ограниченной сеткой часов аудиторных занятий при реализации практической цели обучения – формировании способности и готовности будущего специалиста к межкультурной коммуникации – рекомендуется сделать упор на формирование профессиональной компетенции, которая заключается в овладении умениями профессионально ориентированного иноязычного общения в предполагаемых ситуациях производственной деятельности, а также в ознакомлении с зарубежным опытом в соответствующей области знания.

Последующее обучение характеризуется прагматической ориентацией, увеличением объема приобретаемой студентами профессионально значимой информации, а также в расширении иноязычных знаний, умений и навыков в разных видах речевой деятельности.

Методика преподавания дисциплин «Иностранный язык (английский)» и «Спецкурс иностранного языка (английский язык)» основывается на применении активных методов обучения. Принципами организации учебного процесса являются:

- выбор методов преподавания в зависимости от различных факторов, влияющих на организацию учебного процесса;
- объединение нескольких методов в единый преподавательский модуль в целях повышения эффективности процесса обучения;
- активное участие студентов в учебном процессе;
- проведение практических занятий, направленных на приобретение практических навыков владения языком.

С целью более эффективного усвоения студентами материала рекомендуется при проведении занятий использовать все рекомендуемые пособия и раздаточные материалы, а также технические средства обучения для прослушивания аудиотекстов и просмотра видеофильмов.

*Примечание.* – Примерный план-конспект занятия с использованием базового учебного пособия приведен в **разделе 2.2.**

Работая с лексикой, при объяснении значений отдельных слов кроме перевода как наиболее распространенного способа можно использовать анализ этимологии слов или их сопоставление с другими уже известными иностранными словами – синонимами и антонимами. Выявить значение незнакомого слова возможно через сочетаемость данного слова с другими словами изучаемого языка либо на основе контекста. При работе со специальными текстами незнакомые понятия можно семантизировать с помощью их определений на родном языке и одновременным толкованием на иностранном языке, что будет способствовать дальнейшему правильному употреблению студентами данного слова в речи.

Параллельно с изучением языка как системы отдельных лексических и грамматических структур студенты учатся использовать данные структуры в речи, приобретают навыки употребления их в реальных коммуникативных ситуациях. Естественные ситуации общения могут создаваться на основе читаемых в аудитории текстов из рекомендуемых пособий, когда определенные задания преподавателя по обсуждению содержания текстов побуждают студентов к высказыванию своего оценочного отношения к рассматриваемой проблеме. Более активным такое обсуждение будет при использовании некоторой наглядности – рисунков, схем, диаграмм и т.п., представленных в компонентах данного учебно-методического комплекса.

Закреплению и активизации форм речевого общения в значительной степени способствует просмотр и обсуждение учебных видеопрограмм и видеофильмов. Задача преподавателя заключается в рациональном

построении занятия, на котором применяются видеоматериалы, и умелой организации их обсуждения со студентами с использованием заранее определенных речевых образцов.

Работая с вышеуказанными пособиями, следует комбинировать содержащийся в них материал в зависимости от целей занятия и формируемых навыков.

Цель учебного пособия «*Spoken English for Transportation*» - научить будущих специалистов в области организации перевозок и управления на автомобильном и городском транспорте общаться в различных профессионально ориентированных ситуациях.

Пособие включает 8 разделов, каждый из которых рассчитан в среднем на 4-6 часов аудиторной работы. Гибкая организация позволяет изменять порядок прохождения разделов, а также создавать мини-курсы по определенной тематике (например, курс, посвященный деловым звонкам). Эта особенность построения может быть особенно полезна при меньшем количестве учебных часов. Каждый раздел начинается с вопросов или заданий, которые способствуют погружению студентов в тему с самой первой строки и/ или активизируют знания по данной теме.

При работе над лексической стороной речи рекомендуется заострять внимание студентов на изучении реплик-клише, в том числе этикетного характера (например, в телефонных разговорах); на работе над устойчивыми словосочетаниями, фразовыми глаголами и т.п.

Работу над развитием умений говорения следует подразделить на 2 основных вида: тренировочную и творческую.

Первый вид – это работа над диалогом-моделью при помощи различных упражнений, таких как заполнение пропусков, расстановка реплик в логическом порядке, воспроизведение содержания по ключевым словам и др.

Второй вид работы представляет собой ролевые игры, либо задания — ситуации, где студентам задана форма передачи информации. Такие задания даются в конце каждого раздела, когда студенты готовы к использованию речевых клише, изученной лексики и грамматики.

**Примечание.** – Пример занятия по данному пособию приведен в разделе 2.4.

Разнообразные формы работы по совершенствованию навыков устной речи, ролевые игры, имитирующие типичные ситуации делового общения, вызывают огромный интерес у студентов и повышают их мотивацию.

При изучении грамматики грамматические явления следует рассматривать по мере того, как возникает необходимость в их использовании в речи. Таким образом, пособие обеспечивает повторение изученных грамматических структур в новом контексте, что выводит студентов на уровень достаточно свободного владения грамматическими структурами английского языка.

Пособие также содержит задания, направленные на развитие компенсаторных умений и навыков, в том числе навыков работы со словарем и справочной литературой, умений пользоваться Интернет-ресурсами.

Одним из разделов дисциплины «Спецкурс английского языка» является изучение деловой и транспортной документации. Поэтому преподавателям при работе с учебным пособием «*Transport Business Documentation*» следует делать упор на изучение особенностей стиля делового письма, резюме, контракта, соглашения, транспортной сопроводительной документации. Студенты должны знать стандартные языковые клише и правила внешнего оформления документов.

Весь процесс обучения составлению деловой и транспортной документации следует построить на основе иноязычного текста-образца. Он должен включать несколько этапов.

1. Первичное ознакомление с образцом документа и анализ его структурно-композиционных и лингвистических особенностей, включающий выделение намерения документа, логического плана, объяснение употребления соответствующих языковых средств.
2. Интенсивная тренировка с целью усвоения употребления языкового материала путем выполнения трансформационных, подстановочных, переводческих упражнений.
3. Дальнейшее закрепление и активизация материала текста-образца в аналогичной или новой ситуации при соблюдении управляемости с помощью опор в виде ключевых слов и словосочетаний.
4. Самостоятельное составление целого документа, где студенту сообщается только тема и ситуация общения, в соответствии с которой он должен определить замысел, логическую последовательность и наиболее подходящее языковое оформление.

При изучении дисциплины «Спецкурс иностранного языка (английский язык)» особое внимание следует уделить работе с текстами по специальности, формированию навыков адекватного перевода научно-технической литературы. Этот процесс рекомендуется построить на базе учебного пособия «*English for Transportation*». Его целью является знакомство студентов с основными закономерностями, особенностями и трудностями технического перевода с английского языка на русский. Содержание пособия, его разделы и тематика составлены с учетом профессиональной направленности студентов и предполагают использование полученных навыков перевода, прежде всего, в своей профессиональной сфере. Работа с данным пособием предполагает аудиторные практические занятия, а также определенный объем внеаудиторной самостоятельной работы.

Пособие состоит из 12 тематических уроков (Units), направленных на формирование и совершенствование навыков перевода научно-технического текста. Каждый урок пособия включает:

1. Основной текст для перевода с английского языка на русский.

2. Упражнения на решение грамматических и лексических задач, упражнения на перевод терминов, а также упражнения, направленные на поиск нужной информации в тексте и закрепление навыков как устного, так и письменного аннотирования текста.
3. Дополнительный текст для перевода с английского языка на русский.

Основные тексты уроков подобраны таким образом, чтобы каждый из них отражал определенные грамматические и лексические явления, прорабатываемые в уроке. Тексты составлены на материале оригинальной (аутентичной) научно-технической литературы. Новая лексика, предназначенная для усвоения, вынесена в упражнение № 1.

Грамматические упражнения уроков преследуют цель формирования грамматических навыков перевода. Они решают всю сумму вопросов, возникающих при переводе на русский язык отдельных грамматических явлений: 1) узнавание данного грамматического явления в тексте по формальным признакам (например, по окончанию) или с учетом его синтаксических связей; 2) нахождение соответствий (грамматических или лексических) для изучаемого явления в русском языке.

Лексические упражнения предназначены для формирования и совершенствования необходимых лексических навыков перевода. Они включают перевод синонимов, перевод словосочетаний в узком контексте, перевод терминологических словосочетаний.

В качестве материала для грамматических и лексических упражнений используются предложения и отрывки, взятые из оригинальной научно-технической литературы.

Упражнения на перевод терминов служат для того, чтобы показать, как можно раскрыть значение сложного термина путем установления смысловых связей между его компонентами.

В конце каждого урока приведен текст для перевода с англо-русским словарем. Эти тексты подобраны таким образом, что они содержат пройденные грамматические явления и некоторое количество незнакомых слов.

Пособие рассчитано примерно на 68-72 часов аудиторных занятий. Независимо от того, ведется ли работа под руководством преподавателя или пособие прорабатывается студентами самостоятельно, изучение уроков рекомендуется начинать с проработки лексического материала. Студент знакомится с новыми словами и выражениями, выполняет упражнения на выбор правильного определения и значений слов, на подбор синонимов, на перевод терминологических словосочетаний, а также на поиск интернациональных слов в тексте. Лексические упражнения следует, как правило, выполнять устно. На заключительном этапе работы рекомендуется проводить письменный контроль усвоения слов данного урока с включением в него некоторого количества старых слов.

Грамматические упражнения можно выполнять как письменно, так и устно. При выполнении упражнений письменно студентам рекомендуется выписать в тетрадь ту часть английского предложения, в которой содержится прорабатываемая конструкция, а затем письменно перевести всё предложение, подчеркивая ту его часть, которая соответствует выписанной английской конструкции. Например, прорабатывая грамматическую тему "Перевод эмфатических конструкций", студент, переводя предложение *'It is a transport logistic system that ensures fast and safe movement of goods'*, делает в тетради следующую запись: *'It is a transport logistic system that ensures...'* *'Именно транспортная логистическая система обеспечивает быстрое и безопасное движение товаров'*.

К переводу основного текста следует приступать после закрепления лексического и грамматического материала. Ввиду того, что основной текст относительно велик по объему и содержит значительное количество лексических и грамматических трудностей, рекомендуется делить текст на две части и отводить время для работы над ним на двух занятиях. Переведенная на первом занятии часть текста задается на дом для повторения, а на втором занятии контролируется усвоение этой части и переводится вторая часть текста; на третьем занятии проводится контрольный перевод всего текста.

Следует всегда иметь в виду, что перевод текста должен занимать центральное место в аудиторной работе, так как перевод в присутствии преподавателя дает возможность формировать у студента правильные навыки перевода: умение воспринимать слово как определенную часть речи; умение узнавать грамматическую конструкцию и находить для нее соответствие в русском языке; умение правильно выбирать значение, слова в зависимости от его связей с другими словами в предложении, а также в зависимости от более широкого контекста; умение ориентироваться в предложении, например, временно обойти незнакомое слово, с тем, чтобы вернуться к непонятному месту после перевода остальной части предложения. Таким образом, на связном тексте студент комплексно решает самые разнообразные задачи перевода, которые он по частям учится решать на грамматических, лексических и других видах упражнений.

Дополнительные тексты можно использовать как при самостоятельной работе студентов, так и при работе в аудитории.

На изучение каждого урока следует отводить четыре-шесть часов аудиторных занятий.

После завершения разбора уроков № 3, 6, 9, 12 рекомендуется провести контроль знаний полученных навыков, предложив студентам выполнить контрольные работы.

#### 4.2.1.2 Технологии обучения, рекомендуемые к использованию в процессе обучения иностранному языку

Для вовлечения студентов в поиск и управление знаниями, а также для приобретения опыта самостоятельного решения речемыслительных задач рекомендуется использовать в учебном процессе следующие инновационные технологии обучения:

- *кейс-технология*, в основе которой лежат осмысление, критический анализ и решение конкретных социальных проблем, с которыми студенты непосредственно сталкиваются в жизни;
- *проектную технологию*, представляющую самостоятельную, долгосрочную групповую работу по теме, выбранной студентами в рамках изучаемой проблематики;
- *технологию “обучение в сотрудничестве”*, предполагающую создание условий для работы в командах и позволяющую достаточно эффективно овладеть материалом;
- *игровую симуляцию*, которая представляет собой подражательное, разыгранное воспроизведение межличностных контактов, организованных вокруг проблемной ситуации, максимально приближенной к реальной;
- *презентацию*.

Кратко становимся на каждой из них.

**Кейс-технология (case-study)** состоит в том, что в начале обучения, составляется индивидуальный план, каждый обучающийся получает так называемый кейс, содержащий пакет учебной литературы. Сущность технологии кейс-стади заключается в *самостоятельной иноязычной деятельности* обучающихся в искусственно созданной профессиональной среде, которая даёт возможность соединить воедино теоретическую подготовку и практические умения, необходимые для творческой деятельности в профессиональной сфере. Обучающимся предлагается осмыслить ситуации профессиональной деятельности, которые предусматривают необходимость решения проблемы. В процессе разрешения возникшей проблемы обучающиеся вынужденно актуализируют необходимый для этого комплекс усвоенных знаний. Кейс-технология позволяет учитывать профессиональную подготовку студентов, интересы, выработанный стиль мышления и поведения, что даёт возможность широко использовать его для обучения иностранному языку профессии. Эта технология имеет сильные стороны, к которым можно отнести:

- возможность работы в группах на едином проблемном поле;
- использование краткой информации, снижающей степень неопределенности в условиях лимита времени;
- использование принципов проблемного обучения;
- возможность получения студентами не только знания, но и глубокое осмысление теоретических концепций;



- возможность создания новых моделей деятельности;
- выработки навыков простейшего обобщения информации.

Однако следует отметить, что кейс-технология требует подготовленности студентов, наличия у них навыков самостоятельной работы. Неподготовленность студентов, неразвитость их мотивации может привести к поверхностному обсуждению кейса, поэтому кейс-технология на занятиях по английскому языку рекомендуется применять на старших курсах, т.к. необходим определённый запас знаний по специальности и достаточный уровень владения английским языком.

**Проектная технология** в обучении иностранному языку студентов представляет собой самостоятельную групповую работу по теме-проблеме, выбранной студентами и включающую в себя поиск, отбор и презентацию информации. Благодаря проектной технологии обеспечиваются межпредметные связи, происходит развитие творческих возможностей студентов. Кроме того, обучающиеся учатся анализировать полученную информацию, поскольку в разные моменты познавательной, экспериментальной или прикладной, творческой деятельности они используют совокупность всех интеллектуальных навыков и умений. Умение анализировать полученную информацию—один из главных факторов успешной профессиональной деятельности.

Проектная технология включает в себя несколько видов:

1. проекты-сообщения или исследовательские проекты (Information and Research projects);
2. проекты-интервью (Survey projects);
3. проекты-производства (Production projects);
4. проекты-ролевые игры и драматические представления (Performance and Organisational projects).

Использование технологии проектов:

- развивает интеллект студента, умение планировать и отслеживать последовательность выполняемых действий, усваивать знания и применять их в практической деятельности;
- развивает творческие способности и самостоятельность;
- ориентирует на самостоятельную деятельность обучающихся, которая предполагает владение определенными умениями: анализа, синтеза, мысленного экспериментирования, прогнозирования;
- предполагает совокупность исследовательских, поисковых, проблемных методов;
- позволяет обучить умению получать знания через свою деятельность.

Более подробно хотелось бы остановиться на технологиях «обучение в сотрудничестве» и «игровой технологии», и в частности использовании данных технологий для обучения грамматики.

Технология **«обучение в сотрудничестве»** - это технология, предполагающая создание условий для работы в командах и позволяющая достаточно эффективно овладеть материалом. Главной идеей этой

технологии является учение вместе, а не просто выполнение какой-либо работы совместно. Целью учения в сотрудничестве является «эффект социализации», то есть это не только овладение знаниями, умениями и навыками каждым обучающимся на должном уровне, но и формирование коммуникативных умений в процессе обучения. Данная технология позволяет не только улучшить коммуникативную компетенцию у участников иноязычного общения, но также развивать и совершенствовать ответственность всей команды и лично каждого за результат. Ведь основными принципами обучения в сотрудничестве являются: одно задание для группы, одно поощрение на группу, распределение ролей. Использование технологии «обучение в сотрудничестве» возможно практически на всех этапах обучения: от начального до завершающего. (Рекомендации и пример использования данной технологии на практическом занятии приведены в разделе 2.3).

Кроме того, применение технологии «обучение в сотрудничестве» обеспечивает необходимые условия для активизации познавательной и речевой деятельности каждого студента группы, для формирования необходимых знаний и умений, позволяет наиболее эффективно достигать прогнозируемых результатов обучения и раскрывать потенциальные возможности каждого студента.

В технологии «обучение в сотрудничестве» можно выделить следующие приемы. Приведем некоторые из них и покажем возможности использования каждого из них применительно к грамматике:

- *обучение в команде (student's team learning)*. Главная идея этого типа работы – самостоятельная работа каждого члена группы и постоянное взаимодействие с другими участниками группы. Студенты работают над заданной проблемой, после чего начинается ее обсуждение.
- *«мозаика» (jigsaw)*. При этом типе работы материал разбивается на фрагменты, каждый член группы получает свой фрагмент и работает над ним, затем все участники команды собираются и обмениваются друг с другом информацией. После окончания работы по данному приему, преподаватель может задавать вопросы по всей теме каждому из участников группы. Более того, преподаватель может провести тест-срез, либо контрольную работу;
- *«учимся вместе» (learning together)*. Данный вид работы подразумевает, что каждая из групп получает задание, являющееся частью какой-либо большой темы. В результате работы каждой из групп над своей частью материала достигается усвоение всей темы студентами. Например, группа из 12 человек разбивается на 3 группы (слабые, средние и сильные студенты). Каждой группе дается задание: изучить тему “Употребление прошедшего продолженного времени (Past Continuous)”. Студентам раздаются карточки, при заполнении которых в конце работы составляется полная таблица с правилом. Слабой группе дается задание на выяснение случаев употребления Past

Continuous; группа середнячков выполняет работу по выявлению указателей времени, влияющих на его образование; сильные студенты анализируют схемы предложений;

- *исследовательская работа студентов* – еще одна разновидность технологии «обучение в сотрудничестве». Исследовательская работа подразумевает самостоятельную работу студентов либо индивидуально, либо в группах до 6 человек. Одна большая тема разбивается на подтемы, которые, в свою очередь, делятся еще на каждого члена группы, так что каждый участник исследования имеет возможность внести свой вклад в разработку темы. После проведенного исследования каждая группа делает доклад-презентацию по своей теме.

Еще одна технология, которая представляет интерес – это **коммуникативная игра (КИ)**. КИ – это учебное задание, включающее языковую, коммуникативную и деятельностную задачи, обладающие высокой степенью наглядности и позволяющие активизировать изучаемый языковой материал в речевых ситуациях, моделирующих и имитирующих реальный процесс общения. Решение языковой задачи предусматривает формирование или совершенствование речевых навыков в процессе целенаправленного использования заданного языкового материала в речевой деятельности. Коммуникативная задача заключается в обмене информацией между участниками игры в процессе совместной деятельности. Более того, все внимание студентов направлено на решение задачи общения. Основной акцент в коммуникативных играх делается не столько на правильность употребления языковых явлений, сколько на успешное общение.

Игровая деятельность на уроке иностранного языка позволяет приблизить общение на данном языке к естественному. Игры увлекают даже самых равнодушных к иностранному языку студентов, что в итоге положительно сказывается на успеваемости таких обучающихся.

Кроме того, применение на уроке иностранного языка коммуникативных игр обеспечивает необходимые условия для активизации познавательной и речевой деятельности каждого студента группы, для формирования необходимых знаний и умений; позволяет наиболее эффективно достигать прогнозируемых результатов обучения и раскрывать потенциальные возможности каждого студента.

Можно рекомендовать использовать на занятиях следующие виды коммуникативных игр, которые можно использовать на этапе совершенствования грамматического материала.

1. *Коммуникативные игры, в основе которых лежит прием ранжирования.* Этот прием предусматривает расположение определенных предметов в порядке значимости, важности их предпочтения. В ходе игры часто возникает дискуссия из-за расхождения мнений при распределении информации, и учащиеся обосновывают свой выбор в парах или группах.

2. *Коммуникативные игры, построенные на основе преднамеренного создания различий в объеме информации у учащихся.* Преподаватель преднамеренно неравномерно распределяет определенную информацию между партнерами по общению, благодаря чему стимулируется их речевая деятельность и появляется желание выяснить неизвестные факты. Обмен информацией может быть односторонним или двусторонним. При одностороннем обмене один из партнеров имеет доступ к определенной информации, которой не обладает второй. Второй участник внимает недостающую информацию, чтобы завершить выполнение полученного задания. Двусторонний обмен информацией предполагает, что оба участника частично владеют информацией и должны объединить имеющиеся у них знания для решения поставленной задачи.
3. *Игры, предполагающие группирование или подбор подходящих вариантов.* Каждый студент получает свою часть информации и ему необходимо найти недостающую часть у партнера по общению.
4. *Игры на поиск пары и координацию действий.* Каждый участник в группе имеет свою пару, о которой не знает и которую ему нужно отыскать, задавая учащимся наводящие вопросы.
5. *Интервью.* Цель интервью — опросить как можно большее количество человек с тем, чтобы выяснить их мнения и суждения по заданной проблеме.
6. *Ролевые игры.* Ролевое общение — стимул к развитию спонтанной, неподготовленной речи студентов, направленной на решение коммуникативной задачи. Участники игры должны находиться в таких условиях, в которых им необходимо выяснить социальные, эмоциональные, межличностные стороны отношений. Для ролевой игры необходимо наличие единого сюжета, соответствующего коммуникативной ситуации и ролевых отношений между участниками общения.

Следует отметить, что по статистике, данные виды работы очень нравятся студентам. Изучив различные варианты применения упомянутых выше технологий, мы пришли к выводу, что их целесообразно использовать для формирования и совершенствования грамматических навыков, навыков устного речевого общения, а также на этапе тренировки и применения полученных знаний. Подобные виды работы также уместно использовать в таких разделах урока, как проверка домашнего задания, закрепление, тренировка, развитие умений, повторение изученного материала по теме, разделу. Можно ставить вопросы, направленные на рефлекссию учебного занятия, что будет способствовать развитию логического мышления и речи, что очень важно для развития личности в целом.

### 4.2.1.3 Методические рекомендации по подготовке презентаций

В настоящее время современному инженеру для успешной профессиональной деятельности мало уметь прочесть статью на иностранном языке с целью общей оценки содержания или нахождения нужной информации. Сегодня специалисты все чаще и чаще получают возможность обмениваться опытом, принимая участие в зарубежных конференциях, конгрессах. Поэтому овладение ими навыками подготовки доклада на иностранном языке и выступление на конференции, составление мультимедийной презентации становится просто насущной необходимостью. Такая презентация является сочетанием самых разнообразных средств представления информации, объединенных в единую структуру. Чередование или комбинирование текста, графики, видео и звукового ряда позволяет донести информацию о новом изобретении, разработке какого-либо продукта в максимально наглядной и легко воспринимаемой форме. При подготовке презентации студенты имеют возможность воспользоваться практически любой крупной библиотекой мира, архивами международных научных организаций, богатейшей тематической коллекцией фотографий, что является бесспорным преимуществом мультимедийных средств информации.

Интернет-ресурсы, которые мы рекомендуем студентам для подготовки презентации, можно разделить на три группы:

1. Интернет-ресурсы по обучению языковым средствам, используемым в презентациях. Здесь безусловным лидером является сайт Пирсона Брауна (Pearson Brown) Effective Public Speaking Skills <http://www.effective-public-speaking.com/index.html>.

Этот сайт предлагает практически все структуры и выражения, которые необходимы на стадии подготовки презентации. Сайт полезен как преподавателям, так и студентам. Преподавателям он подскажет, на какие аспекты обратить внимание, и предложит лексические ресурсы по подготовке материалов для занятий в форме упражнений и тестов. А студентам он даст возможность работать в индивидуальном режиме дома и обрабатывать лексические формы в интерактивных упражнениях.

2. Видео-Интернет-ресурсы, обучающие различным аспектам презентации (как начать и закончить презентацию, как использовать невербальные средства коммуникации, как правильно сделать Power Point Presentation, какие риторические приемы можно использовать в речи для достижения максимального эффекта). Здесь студентам можно рекомендовать следующий сайт: <http://www.youtube.com/watch?v=0vo2KJdgCqQ>.

Информацию о том, как правильно создать слайд, какой шрифт и цвет использовать, каково должно быть соотношение текста «картинки»/свободного пространства, как правильно комбинировать текст и образ для лучшего эффекта можно найти на сайте <http://www.presentationzen.com>.

3. Аутентичные материалы, сделанные известными людьми; речи всемирно известных политических лидеров и бизнесменов, клипы из художественных фильмов. На сайте <http://www.youtube.com/watch?v=PZoPdBh8KUs> можно посмотреть, как Стив Джобс, создатель i-Phone, компьютера MacBook Air, делает классическую презентацию i-Phone с использованием приемов ораторского искусства. На сайте [http://www.ted.com/index.php/speakers\\_'TED TALK ideas worth spreading'](http://www.ted.com/index.php/speakers_'TED TALK ideas worth spreading') можно найти коллекцию эффектных презентаций лидеров общественного мнения, мыслителей, учителей. Сайт по искусству публичных выступлений <http://www.americanrhetoric.com/> содержит архив политических, религиозных выступлений речей из кинофильмов, а также статьи, глоссарий по риторике. Этот сайт поможет тем, кто при обучении презентации хочет сделать акцент на самом выступлении и искусстве риторики.

#### **4.2.1.3.1 Требования к составлению презентации**

1. Презентация на английском языке на определенную тему выполняется в PowerPoint для подготовки к выступлению на семинаре, конференции или для поддержки доклада. Основная задача – подготовить презентацию так, чтобы изображение на слайдах в презентации, сделанных в PowerPoint, было совмещено с текстом выступления на английском языке.

2. Непосредственно графические изображения на слайдах не должны быть основной частью и нести большую смысловую нагрузку, чем речь выступающего с презентацией. Наоборот, презентация, выполненная в PowerPoint, подкрепляет текст выступления графическим наполнением, придавая большую содержательность выступлению. Поэтому нужно подготовить презентацию с учетом данного фактора.

3. Выступление с презентацией на английском языке не следует перегружать пересказом всего и вся. Следует сосредоточиться на основных моментах темы и ключевых особенностях, которые будут изображены на слайдах в презентации в PowerPoint. При этом презентация на английском языке включает в себя только основные положения текста выступления. Не стоит пытаться вместить в презентацию весь текст выступления. В презентации не должно быть ничего лишнего. Каждый слайд должен представлять собой необходимое звено повествования и работать на общую идею презентации.

4. Слайды в презентации не повторяют выступление, а дополняют его в качестве графических иллюстраций. Не стоит перегружать слайды лишними деталями. Иногда лучше вместо одного сложного слайда представить несколько простых. Не следует пытаться "затолкать" в один слайд слишком много информации.

5. Не стоит в презентации PowerPoint на английском языке создавать слайды с большим количеством перечислений текстовой или числовой информации. Слайды с перечислением плохо воспринимаются аудиторией,

так как это не лист бумаги, который человек держит в руках. Однако если подойти к построению слайда творчески и красиво подготовить презентацию и оформить представленный текст, то списки перечислений могут выглядеть вполне уместно. В этом случае перечисление должно органично выделяться на общем пространстве слайда.

6. Если в выступлении планируется представить большой объем важной информации в текстовом виде, которые также стоит отразить в слайдах, то можно использовать прием тезисной передачи информации для того, чтобы подготовить презентацию. Суть заключается в том, чтобы слайд презентации на английском языке содержал не просто текстовый массив, в котором передается интересующая информация, а включал три или четыре предложения, которые в лаконичной форме передают основную суть.

7. Презентация должна быть краткой, доступной и композиционно целостной. Продолжительность презентации должна составлять не более 15 минут. Для демонстрации нужно подготовить примерно 10-12 слайдов (показ одного слайда занимает около 1 минуты, плюс время для ответов на вопросы слушателей).

8. При изложении материала следует выделить несколько ключевых моментов и в ходе демонстрации время от времени возвращаться к ним, чтобы осветить вопрос с разных сторон. Это гарантирует должное восприятие информации аудиторией.

9. Дополнительные эффекты не должны превращаться в самоцель. Их следует свести к минимуму и использовать только с целью привлечения внимания аудитории к ключевым моментам демонстрации. Звуковые и визуальные эффекты ни в коем случае не должны выступать на передний план и заслонять полезную информацию.

10. Шрифты рекомендуется использовать стандартные – Times, Arial. Лучше всего ограничиться использованием двух или трех шрифтов для всей презентации. Например, основной текст презентации – шрифт Times New Roman, заголовок слайда – Arial.

11. Целесообразно применение различных маркеров для выделения элементов текста (маркированные списки).

12. Мультимедийная презентация должна обладать удобной системой навигации, позволяющей легко перемещаться по презентации.

13. Каждый слайд презентации должен иметь заголовок.

14. Слайды должны иметь ссылки на литературные источники, электронные библиотеки и на источники информации в сети Интернет.

15. Презентация должна обладать доступностью – быстрой загрузкой, без усложнения эффектами.

16. Важно проверять презентацию на удобство чтения с экрана компьютера. Тексты презентации не должны быть большими. Рекомендуется использовать сжатый, информационный стиль изложения материала.

17. Выступление в виде презентации на английском языке должно соответствовать уровню владения языком выступающего.

18. Презентация предполагает определенную структуру:

- 1) выступление с изложением цели и основной идеи выступления;
- 2) развитие основной идеи;
- 3) заключение;
- 4) приглашение к обсуждению услышанного.

19. Студенты должны уметь не только подготовить выступление на английском языке, но и эффективно преподнести его аудитории, предварительно установив с ней контакт и поддерживая его в течение всей презентации. С этой целью студентам предлагается использовать следующие фразы:

## Начало

### Starting

#### Formal Meeting

**Good morning/afternoon/evening** dear friends. My name is ... and I'm a student of ... department. Our **purpose** this morning is to hear a presentation, and to **discuss** it with all of you.

**Take a seat** – присаживайтесь, **purpose** – цель, **get started** – начать, **discuss** – обсуждать, **feel free to ask** – свободно спрашивайте, **fresh ideas** – свежие идеи.

#### Informal Meeting

Okay everybody. Please **take a seat**. Let's **get started**. If you have any questions, please **feel free to ask** me at the end of the presentation. We'll hear a presentation and discuss it to see if there are any **fresh ideas**.

## Главная часть

Здесь необходимо рассказать о структуре презентации.

### Introduction

#### Formal Meeting

As you already know, today's presentation **is designed** to present some important points of ... This first **slide** shows our **agenda for** the day.

First, I will begin with an **overview** of ... Then, I will **present the data** that I gathered and my ideas for ... Then we'll discuss..., and **at last** I'll make a **conclusion** with the main recommendations.

#### Informal Meeting

All right, **let me start by saying thanks** to all of you for the interest in this presentation.

I would like to talk to you today about .... for... minutes.

First, I would like to talk about.... Then I would like you to take a look at... Following that we're going to talk about... Then I'm going to **wrap things up** with our team's recommendations.



Lastly we are going to discuss...

Since we have very limited time today, please **hold your questions** until the end of the presentation.

Any questions **so far**? Please feel free to **interrupt** me at any time.

**Be designed** – быть задуманным, **slide** – слайд, **agenda** – повестка дня, **let me start** – позвольте начать, **say thanks** – благодарить, **overview** – обзор, **present the data** – представлять данные, **at last** – наконец, **conclusion** – заключение, **wrap things up** – завершим, **hold the questions** – держать (не забывать) вопросы, **so far** – пока, **interrupt** – прерывать.

Представляя **визуальные материалы** своей презентации, необходимо также иметь некоторое количество дежурных фраз, которые создают "**связки-переходы**" между слайдами, и помогают слушателям не потерять основной идеи, заложенной в презентации.

Некоторые фразы, данные ниже, помогут не растеряться и сфокусировать внимание аудитории на наиболее важных моментах презентации. Фразы одинаковы для любого типа презентации – формального и неформального.

### English

Now we will look at...  
I'd like now to discuss...  
Let's now talk about...  
Let's now turn to...  
Let's move on to...  
That will bring us to our next point...  
Moving on to our next slide ...

### Russian

Теперь взглянем на ...  
Теперь мне хотелось бы  
обсудить...  
Давайте теперь поговорим о ...  
Теперь давайте перейдем к ...  
Продолжим с ...  
Это отсылает нас к следующему  
пункту ...  
Двигаемся к нашему следующему  
слайду ...

Также необходимо знать элементарные названия **графиков, таблиц** и т.д. на английском языке.

**Pie chart** – круговая диаграмма, **table** – таблица, **bar chart** – гистограмма, **line graph** – линейная диаграмма, **market share** – сегмент рынка.

Следующие термины помогут корректно донести до слушателя основную идею презентации и доходчиво представить информацию в графиках, таблицах и т.д.:

**Represent** – представлять, **rise slowly** – медленно подниматься, **go up steadily** – неуклонно подниматься, **rise gradually** – постепенно расти, **rise sharply** – резко взлететь, **hold steadily** – держаться на определенном уровне, **descend** – снижаться, **fall/go down/drop** – падать, **fall slowly** – медленно падать, **fall steadily** – неуклонно снижаться, **drop sharply** – резко упасть, **justify** – подтверждать, **currently** – в настоящее время, **raise the price** – поднять цену, **compared to** – по сравнению с, **revenue** – доход, **rise by 5%** –

подняться на 5%, **drop from ... to ...** - цена упала с ... до..., **go to the level of 35%** - выйти на уровень 35%.

## Заключение

Фразы, заключающие презентацию, как правило, мало отличаются в формальном и неформальном вариантах.

### English

Let's sum it up.  
Let's wrap it up.  
I would like to sum up the main points again...  
So, in conclusion...  
Finally let me just sum up today's main topics...

### Russian

Давайте суммируем.  
Завершим.  
Еще раз хотел бы суммировать главное...  
Итак, в заключение...  
Наконец, подведем итог сегодняшним главным моментам...

## Ответы на вопросы

Презентация может быть представлена так, что вопросов не возникает. Но плох тот оратор, который не подготовился к возможным вопросам заранее. Поэтому важным моментом в подготовке к презентации на английском языке является, в том числе, и вычисление "слабых" мест своего выступления и подготовка ответов на возможные вопросы заранее.

Тем не менее, все вопросы просчитать не всегда возможно. Поэтому хорошо, если будет заготовлена пара шаблонных фраз, которые позволят немного "потянуть" время и собраться с мыслями, если вдруг будет задан совершенно неожиданный трудный вопрос.

Потренироваться в ответах на вопросы можно с любым человеком, который знает английский язык. Это может быть одноклассник, сокурсник с достаточно высоким уровнем владения английским языком.

### English

I think I answered your question earlier.  
I'm glad you asked that.  
Well, as I already said...  
That's a very good question (of you to ask).  
So you are asking about...  
If I've understood you correctly, you are asking about...

### Russian

Я думаю, я ответил уже на Ваш вопрос ранее.  
Рад, что Вы спросили об этом.  
Итак, как я уже и говорил ...  
Очень хороший вопрос (который Вы задали).  
Итак, Вы спрашиваете о ...  
Если я Вас правильно понял, Вы спрашиваете о ...

#### 4.2.1.3.2 Алгоритм работы над презентацией:

- 1) Структуризация отобранного материала;
- 2) Составление сценария реализации;
- 3) Разработка дизайна презентации;
- 4) Подготовка медиафрагментов (текстов, иллюстраций, видеосъемки, запись аудиофрагментов);
- 5) Подготовка музыкального сопровождения;
- 6) Тестирование-проверка.

Одним из основных компонентов дизайна презентации является учет физиологических особенностей восприятия цветов и форм. К наиболее значимым из них относят:

- стимулирующие (теплые) цвета способствуют возбуждению и действуют как раздражители (в порядке убывания интенсивности воздействия): красный, оранжевый, желтый;
- дезинтегрирующие (холодные) цвета успокаивают, вызывают сонное состояние (в том же порядке): фиолетовый, синий, голубой, сине-зеленый; зеленый;
- нейтральные цвета: светло-розовый, серо-голубой, желто-зеленый, коричневый;
- сочетание двух цветов — цвета знака и цвета фона — существенно влияет на зрительный комфорт, причем некоторые пары цветов не только утомляют зрение, но и могут привести к стрессу (например, зеленые буквы на красном фоне);
- составление цветовой схемы презентации начинается с выбора трех главных функциональных цветов, которые используются для представления обычного текста, гиперссылок и посещенных ссылок. Цветовая схема должна быть одинаковой на всех слайдах. Это создает у аудитории ощущение связности, преемственности, стильности, комфортности;
- при выборе шрифтов для вербальной информации следует учитывать, что прописные буквы воспринимаются тяжелее, чем строчные; отношение толщины основных штрихов шрифта к их высоте ориентировочно составляет 1:5; наиболее удобочитаемое отношение размера шрифта к промежуткам между буквами: от 1:0,375 до 1:0,75;
- наиболее хорошо воспринимаемые сочетания цветов шрифта и фона: белый на темно-синем, лимонно-желтый на пурпурном, черный на белом, желтый на синем;
- белое пространство признается одним из сильнейших средств выразительности, малогарнитурный набор — признаком стиля;
- любой фоновый рисунок повышает утомляемость глаз обучаемого и снижает эффективность восприятия материала;

- фон является элементом заднего (второго) плана, должен выделять, оттенять, подчеркивать информацию, находящуюся на слайде, но не заслонять ее;

- большое влияние на подсознание человека оказывает мультипликация. Ее воздействие гораздо сильнее, чем действие обычного видео. Четкие, яркие, быстро сменяющиеся картинки легко «впечатываются» в подсознание. Причем, чем короче воздействие, тем оно сильнее;

- любой нерелевантный движущийся (анимированный) объект понижает восприятие материала, оказывает сильное отвлекающее воздействие, нарушает динамику внимания;

- включение в качестве фонового сопровождения нерелевантных звуков (песен, мелодий) приводит к быстрой утомляемости аудитории, рассеиванию внимания и снижению производительности обучения.

Учет указанных особенностей оформления презентации в значительной степени влияет на эффективность восприятия представленной в ней информации.

Важно неоднократно «прогнать» готовую презентацию, чтобы избежать досадных технических сбоев, отработать произношение, выверить время.

#### **4.2.1.3.3 Критерии оценки презентации**

Критериями оценки презентации являются параметры, связанные с содержательной стороной исследования:

- глубина исследования;
- четкость;
- самостоятельность выводов;
- умение выделять главную и второстепенную информацию;
- умение обобщать, критически анализировать и давать собственную оценку обнаруженным фактам;
- последовательность изложения;
- языковое оформление (правильность произношения, адаптированность языка).

С формальной стороны оцениваются, прежде всего, уместность и адекватность использования мультимедийных технологий, т.е. соответствие выбора технических средств цели их применения (подчеркнуть, выделить мысль, показать причинно-следственные связи явлений, их иерархический характер, структурировать текст, проиллюстрировать примерами), оформление слайдов.

Целесообразно перед просмотром студенческих презентаций дать остальным студентам в группе задание проанализировать предлагаемую работу по 10-балльной шкале по нижеуказанным критериям:

- правильная организация структуры презентации;
- умение ясно и лаконично излагать информацию;

- владение правильной техникой речи (голос, дикция, темп, интонация, паузы);
- владение техникой невербального поведения;
- соответствие интересам и ожиданиям аудитории;
- умение устанавливать контакт с аудиторией;
- умение отвечать на вопросы аудитории;
- умение правильно использовать наглядный материал;
- соблюдение регламента выступления.

Студентам необходимо составить связное высказывание-оценку выступления одnogруппника, выделить очевидные недостатки и промахи, определить, что мешало восприятию предлагаемого материала, дать рекомендации, которые помогли бы исправить допущенные ошибки.

Заключительную оценку предъявленной презентации дает преподаватель. Замечания должны носить исключительно конструктивный характер.

Основными недостатками создаваемых студентами мультимедийных презентаций являются:

1) их формальный характер, т.е. отсутствие критического анализа проблемы, склонность к копированию и "склеиванию" информации, полученной из Интернет-ресурсов, и ее формальное оформление в виде слайдов;

2) отсутствие лаконичности, логичности в составлении последовательности слайдов, использовании ссылок;

3) отсутствие осознания назначения самой презентации как иллюстративного способа предъявления результатов исследования, играющего роль вспомогательного технического средства;

4) увлечение внешним оформлением, использованием анимационных спецэффектов в ущерб содержательной стороне.

Указывая на подобные недостатки студенческих работ в корректной форме, преподаватель должен подробно объяснить, как их можно было бы устранить. Главное – сохранить мотивацию студентов, их заинтересованность данным видом деятельности, показать реальные пути решения той или иной проблемы.

Сознательный подход студентов к собственной деятельности в рамках работы по составлению мультимедийных презентаций в сопровождении преподавателя, выступающего в роли консультанта или эксперта, способствует формированию у них критически рефлексивного мышления.

#### 4.2.2 Методические рекомендации по обучению профессионально ориентированной устной речи (на примере методического пособия по обучению устной речи для студентов технических вузов. Авторы: Ваник И.Ю., Ляхевич Е.Г., Лапко О.А., Сурунтович Н.В. – Минск, 2012.)

В связи с тем, что в настоящее время обучение говорению является одной из главных целей обучения иностранному языку, ведущий методический принцип данного учебного пособия – принцип коммуникативной направленности. Это означает, что обучение строится на вовлечении студентов в устную коммуникацию, т.е. общение на изучаемом языке должно реализовываться на протяжении всего курса в форме монологической и диалогической речи.

Следуя данному подходу, методическое пособие по обучению устной профессионально ориентированной речи студентов включает в себя комплекс упражнений, направленных на формирование навыков устной монологической и диалогической речи.

Говорение характеризуется наличием сложной мыслительной деятельности с опорой на речевой слух, память, прогнозирование, внимание. Поэтому для говорения как самостоятельного вида речевой деятельности характерны три этапа: этап планирования, осуществления и контроля. Рассмотрим данный процесс на примере формирования навыков устной монологической и диалогической речи при изучении темы “The BNTU”.

На первом этапе (этапе планирования) изучения темы The BNTU мы рекомендуем:

1. выполнение упражнений Starting-up для активизации фактических знаний студентов и подготовки их к восприятию нового тематического материала. Предпочтительно использовать условно-речевые упражнения, которые характеризуются ситуативностью, наличием речевой задачи. Следует отметить необходимость использования вербальных опор ФСТ, особенно для студентов с низким уровнем языковой подготовки. Например, *Give your opinion on the statement ‘Knowledge is power’, using the expressions from the Useful language box:*

##### ***Useful language***

*In my opinion, one of the most important things in our life is...*

*I consider that learning is always hard but...*

*From my point of view, many young people...*

*As I see it, it is necessary to ...*

*I believe getting higher education is a good way to find...*

*It seems to me, education provides a good opportunity to...*

*I’m sure that deep knowledge in different fields helps to...*

*It is clear that in order to be successful you have to...*

2. введение блока новых лексических единиц, их тренировку и закрепление при помощи переводных и беспереводных способов их семантизации, используя подстановочные и трансформационные упражнения. Например,

- *Complete the sentences below with the following word combinations.*

Academic staff, full-time and part-time basis

1. ... supports students to develop the skills they need to do well in their studies.

2. The university offers an opportunity for students to study on ...

- *Translate the sentences below into English using your active vocabulary.*

На **втором этапе (этапе осуществления)** обучения, учитывая низкий уровень подготовки студентов технического вуза, следует использовать **текст-образец**. Следует отметить, что при отборе текстов для обучения монологической речи необходимо обращать внимание на их развивающий и культурологический потенциал, мотивационную способность, а также на проблемный и изучающий характер содержания, то есть, может ли он являться источником дополнительной информации, образцом, стимулом для порождения собственного высказывания. Учитывая невысокий уровень языковой подготовки студентов технического вуза, преподавателю предлагается детально проработать текстовый материал на всех языковых уровнях:

- на *фонетико-фонологическом уровне* при чтении текста следует акцентировать внимание студентов на лексических единицах, сложных для произношения. Например, *Check the unknown words in the dictionary, Repeat after the teacher.*

- на *уровне прогнозирования* преподаватель может предложить студентам сделать предположение о содержании текста по заглавию, по первому абзацу, по ключевым словам. Например, *Do the general knowledge quiz below and then check your answers by reading the text.*

- на *лексико-грамматическом уровне* при переводе текста преподавателю необходимо обращать внимание на лексические и грамматические особенности его перевода: явления интерференции, перевод многозначных и многофункциональных слов, на словообразовательный анализ, а также анализ структуры сложного предложения и сложных оборотов с неличными формами глагола. Так, например, в предложении, *'The BNTU graduates stand at the forefront of Belarusian industry possessing strong leadership characteristics, ingenuity and technical proficiency'* следует обратить внимание на контекстуальное значение слова *'forefront'*, на способы словообразования слов *'Belarusian'*, *'leadership'*, на перевод именной группы *'leadership characteristics'*; а также на перевод неличной формы глагола *'possessing'*.

- на *уровне понимания прочитанного текста* преподавателю рекомендуется выполнять репродуктивные упражнения. При осуществлении контроля за сформированностью монологической речи следует исходить из того, что на репродуктивном уровне контролируется правильность воспроизведения,

темп и эмоциональная окрашенность. Например, *Answer the questions about the text, Define the statements as true or false.*

На **третьем этапе (этапе контроля)** студенты строят самостоятельные монологические высказывания. Следует использовать условно-речевые и речевые упражнения, предполагающие некоторые элементы творческого и самостоятельного высказывания. Так, студент комбинирует изученные ранее речевые образцы, добавляет или изменяет лексические единицы, а также на основе своего языкового и речевого опыта может выразить свое отношение к фактам и событиям, построить высказывание в соответствии со своим замыслом. На репродуктивно-продуктивном уровне контролируется и оценивается объем высказывания, языковая правильность и соотношение репродуктивного и продуктивного. На продуктивном уровне оценивается объем, его языковая правильность и самостоятельность в выборе языковых средств, в логике построения, умении начать изложение, развернуть его должным образом и закончить высказывание. Например, *'The University Open Day is a day to discover what it's really like to be at University'. Have you attended the Open Day? If yes, then was the visit useful? Describe your general impressions. If you haven't attended the Open Day, describe what applicants (абитуриенты) can find out on this day using your general knowledge and expressions from the Useful language box.*

#### ***Useful language***

*to have the opportunity to look around the campus, to find out detailed information about the admission process and career prospects, to take part in a number of talks on many aspects of life and study at the University, to find information on issues such as scholarships and fees (оплата за обучение), accommodation and extracurricular activities, to gain impression of a student life at the University, to have the chance to talk to the current students and hear a firsthand account (мнение из первых уст) of the student experience, to learn more about courses and facilities, to have the opportunity to ask the Faculty staff any questions about the Faculty and the courses it offers*

***You can begin like this:*** *'The Open Day as a whole was an amazing experience because it gave me an idea of what to expect if I were to study at the BNTU. I learnt more about ...'*

Что касается обучения диалогической речи на **втором и третьем этапах**, необходимо учитывать **технику пошагового овладения диалогическим единством**. Используя этот способ, удобно обучать разворачиванию реплики и вкраплению микродиалогов. Для этого стимулирующая реплика строится таким образом, что она вызывает развернутый ответ. Например,

*A: Excuse me, are you also a BNTU student?*



*B: Yeah, I'm a first-year student of Mechanical Engineering Faculty.*

Техника пошагового овладения диалогической речью подразумевает несколько уровней овладения диалогическим единством. Однако в условиях технического вуза из-за ограниченного количества часов, отводимого на изучение дисциплины «Иностранный язык (английский)», мы рекомендуем объединять несколько уровней:

- *Овладение студентами отдельными репликами (переспрос, запрос об информации, просьба) и умение соотносить их друг с другом (утверждение-переспрос, утверждение-несогласие).* Например,

*Put the words in these questions in the correct order. Then match them with the answers to make a dialogue about the University.*

1. it / for you / hard / university life / to settle down / was / into?
2. any / there / difference / is / university and school / between?
3. you / feel / any / do / support / the teachers / from?

a. Well, it was a bit scary, to be honest, leaving home for the first time, going to live in a new place, but I quickly settled in and found it very friendly.

b. I think there's a big difference between university and school. Here you're far more independent and responsible for your own learning.

c. There are really good teachers. They really give a lot of help. It might seem there's no support there, but as soon as you just ask for it, it's always available.

- *Овладение типами микродиалогов (двусторонний диалог-расспрос) и на основе этих микродиалогов овладение умением вести развернутый диалог.* Так, например, в данном пособии студентам предлагается изучить несколько диалогов, объединенных общей тематикой, и на их основе составить развернутый диалог, используя различные типы микродиалогов. Например,

*Role-play the University Open Day. Work in pairs to complete the dialogues below. Discuss university life at the BNTU. Student A is an applicant who wants to learn more about university life. Student B is a current BNTU student who offers firsthand advice based on his/her experience of life at the University.*

### Dialogue 1

A: Excuse me, are you a BNTU student?

B: Yeah, I'm a first-year student of Mechanical Engineering Faculty.

A: You know, I'm going to enter the BNTU this year. Do you have any idea if all the Faculties are located on the campus?

B: Sure, many Faculties including Automobile and Tractor Faculty are located on the campus, others are in a short walk from it.

### Dialogue 2

A: Excuse me, I'm looking for the Automobile and Tractor Faculty?

B: Yeah, it's situated in Building 8.

A: Oh, the campus is so large! Is there a library and a sports complex?

B: Actually, there are all these facilities on the campus. The BNTU library is one of the largest university libraries in Belarus. A state-of-the-art sports complex offers indoor and outdoor sports facilities.

### Dialogue 3

A: Excuse me, is there a café on the campus?

B: Sure, there is a café or a canteen in each building. They serve a wide range of hot meals, snacks, drinks.

A: Thanks. By the way, don't you live in the halls of residence? I'm just interested, as I'm going to enter the BNTU this year.

B: I see. Yeah, I have the University's accommodation.

### Dialogue 4

A: Excuse me, is there a photocopy centre on the campus?

B: Yes, the nearest one is in the library.

A: What other facilities are available at the library? I'm just interested, as I'm going to enter the BNTU this year.

B: Oh, I see. As I know, there is a Wireless Access Point, a lot of reading halls and computing centers.

**На этапе контроля** студенты составляют диалог в соответствии с ситуацией, данной преподавателем, на основе изученных ранее диалогических единств. Суть этой тактики заключается в том, что когда перед говорящим возникает цель, он обдумывает, как ее можно достичь, т.е. тактическую линию своего поведения. Преподаватель в данном случае может оказать помощь, предоставляя функциональную модель диалога студентам.

## **4.2.3 Методические рекомендации по изучению дисциплин «Иностранный язык (английский)» и «Спецкурс иностранного языка (английский язык)» для студентов**

### **4.2.3.1 Общие методические указания по изучению дисциплин**

Успешное овладение иностранным языком не только зависит от профессионального мастерства преподавателя, но и от умения студентов понять и принять задачи и содержание учебных дисциплин. Необходимо принимать активное участие в учебном процессе и быть ответственным за то, что делаете на практических занятиях по английскому языку и во время самостоятельной внеаудиторной подготовки.

Успешное изучение иностранного языка возможно только при систематической самостоятельной работе над ним. Важную роль при этом играют накопление достаточного словарного запаса, знание грамматических конструкций и фонетического строя изучаемого языка посредством внеаудиторного чтения.

Для того чтобы научиться правильно читать, понимать на слух иностранную речь, а также говорить на иностранном языке, следует широко использовать технические средства, сочетающие зрительное и звуковое восприятие: слушать аудиозаписи, смотреть видеофильмы на иностранном языке.

Для формирования умений и навыков работы над текстом без словаря необходима регулярная и систематическая работа над накоплением запаса слов, а это в свою очередь, неизбежно связано с развитием навыков работы со словарём. Кроме того, для более точного понимания содержания текста рекомендуется использование грамматического и лексического анализа текста.

Работу над закреплением и обогащением лексического запаса рекомендуем строить следующим образом:

- Ознакомьтесь с работой со словарём – изучите построение словаря и систему условных обозначений. При переводе технических текстов по специальности пользуйтесь помимо общезыкового словаря также отраслевыми техническими словарями. Вам может быть полезен следующий словарь, который можно найти в режиме on-line:

Большой англо-русский политехнический словарь  
<http://www.classes.ru/dictionary-english-russian-polytechnicalenru.htm>.

- Выписывайте незнакомые слова в тетрадь в исходной форме с соответствующей грамматической характеристикой, т.е. имена существительные – в именительном падеже единственного числа; глаголы – в неопределённой форме (в инфинитиве), указывая для неправильных глаголов основные формы; прилагательные – в форме мужского рода единственного числа. Слова в тетрадь-словарь лучше выписывать не по алфавиту, а по тематическим группам, например: «Автомобили и их детали», «Компьютеры и их комплектующие», «Инструменты и приборы», «Различные виды материалов» и т.д.

- Записывая английское слово в его традиционной орфографии, напишите рядом в квадратных скобках его фонетическую транскрипцию.

- Выписывайте и запоминайте в первую очередь наиболее употребительные глаголы, существительные, прилагательные и наречия, а также строевые слова (т.е. все местоимения, модальные и вспомогательные глаголы, предлоги, союзы и частицы).

- Учитывайте при переводе многозначность слов и выбирайте в словаре подходящее по значению русское слово, исходя из общего содержания переводимого текста.

- Выписывая так называемые интернациональные слова, обратите внимание на то, что наряду с частым совпадением значений слов в русском и иностранном языках бывает сильное расхождение в значениях слов.

- Эффективным средством расширения запаса слов служит знание способов словообразования в иностранном языке. Умея расчленить производное слово на корень, префикс и суффикс, легче определить значение неизвестного нового слова. Кроме того, зная значение наиболее употребительных префиксов и суффиксов, вы сможете без труда понять значение всех слов, образованных от одного корневого слова, которое вам известно.

- В каждом языке имеются специфические словосочетания, свойственные только данному языку. Эти устойчивые словосочетания (так называемые идиоматические выражения) являются неразрывным целым, значение которого не всегда можно уяснить путём перевода составляющих его слов. Устойчивые словосочетания одного языка не могут быть буквально переведены на другой язык. Такие выражения следует выписывать и заучивать наизусть целиком.

Для практического овладения иностранным языком, необходимо усвоить его структурные особенности, в особенности те, которые отличают его от русского языка. К таким особенностям относится, прежде всего, твёрдый порядок слов в предложении, а также некоторое число грамматических окончаний и словообразовательных суффиксов.

Учебные умения, необходимые для успешной учебной деятельности можно и нужно развивать самостоятельно и с помощью преподавателя.

#### **4.2.3.2 Методические рекомендации по организации самостоятельной работы студентов**

Обучение английскому языку в техническом университете предполагает следующие формы самостоятельной работы:

- индивидуальная самостоятельная аудиторная работа под контролем преподавателя;
- обязательная самостоятельная работа студентов по заданию преподавателя, выполняемая во внеаудиторное время, в том числе с использованием технических средств обучения.

В соответствии с учебным планом специальности 1-44 01 01 Организация перевозок и управление на автомобильном и городском транспорте на базовый курс обучения английскому языку и на спецкурс предусматриваются 316 часов самостоятельной работы.

Основной целью самостоятельной работы является закрепление, углубление и совершенствование полученных знаний, навыков и умений, т.е. достижение соответствующего уровня иноязычной компетентности за период обучения.

Для достижения данной цели самостоятельная работа должна носить систематический и непрерывный характер.

При подготовке к каждому занятию необходимо обратиться к уроку в основном учебном пособии по данной теме и дополнительным учебным пособиям, чтобы уточнить новую лексику, терминологию, грамматические структуры. При работе с лексико-грамматическим материалом необходимо стремиться не только к узнаванию слова или грамматического оборота, но и к пониманию цели его употребления в данном контексте, функциональной нагрузки, которой данная языковая единица обладает.

Организацию самостоятельной работы следует осуществлять с учетом особенностей различных видов речевой деятельности.

*1. Работа с текстами, составление тематического глоссария по прочитанному тексту.*

Рекомендуется: неоднократно прочитать текст вслух, отработать технику чтения. Обратить внимание на чтение трудных слов (после текстов часто указываются трудные слова с транскрипцией). Составить тематический глоссарий по прочитанному тексту.

*2. Выполнение различного рода коммуникативных упражнений по закреплению навыков.*

Рекомендуется: сначала записать коммуникативное высказывание (ответ на вопрос, пересказ текста, и др.) в письменной форме, затем отработать это высказывание в устной форме. Можно записывать свой ответ дома на магнитофон с его последующим прослушиванием. При подготовке обратить внимание на формат, структуру, речевые клише для данной функции (формальный - неформальный стиль, процедура и структура общения и т.п.).

*3. Чтение материалов учебных пособий или дополнительной литературы по заданной теме.*

Рекомендуется выполнять задание по чтению дополнительной литературы небольшими порциями несколько раз в неделю, так как трудно прочитать и проработать большой объем страниц за один прием.

*4. Написание делового письма.*

Для успешного овладения навыками письменной деловой речи важно следовать следующим рекомендациям:

- внимательно прочитайте задание;
- определите вид письма;
- найдите образец данного вида делового письма в учебном пособии;
- вспомните структуру письма, оформление, речевые обороты, объем;
- напишите деловое письмо, учитывая все основные требования;
- перечитайте свою работу, обращая внимание на содержание, логику изложения, формат письма, лексику и грамматику.

*5. Подготовка к зачетам, экзамену.*

Узнайте у преподавателя, в какой форме будет проводиться зачет или экзамен, и какие типы заданий он будет включать. При подготовке делайте

особенный упор именно на те виды заданий, которые будут на зачете или экзамене. При выполнении письменного перевода текста следует избегать дословного перевода, смысл фраз и предложений нужно передавать целиком.

Устные темы надо составлять заранее (желательно самому, на худой конец, компилируя из нескольких пособий – так больше шанс избежать ошибки) и учить наизусть. Выучите список слов-связок типа *'in fact'*, *'to my mind'*, *'for example'*, *'at the same time'*, чтобы заполнять ими паузы, когда будете собираться с мыслями.

Немаловажно также помнить, что на любом экзамене время на подготовку ответа будет ограничено. Учитесь работать в сжатые сроки: ставьте перед собой часы, засекайте время и начинайте читать-писать-переводить.

Пытайтесь равномерно распределять время между заданиями. Одна из самых распространенных ошибочных стратегий во время экзамена — медленно и вдумчиво сделать первую половину, а потом вдруг обнаружить, что время почти закончилось и наспех, кое-как, доделать вторую.

Помните, что Вы не сможете за несколько дней выучить все. К сожалению, студенты не столько учат материал, сколько зазубривают его. Следует иметь в виду, что, во-первых, сведения, выученные в большом объеме за короткий период времени, которые Вы не обдумали и не усвоили должным образом, не задерживаются в памяти дольше, чем на пару дней. Во-вторых, заучивание наизусть требует гораздо больших затрат времени и энергии нежели «правильное» освоение материала. Поэтому не расслабляйтесь во время учебного процесса. Усваивайте учебный материал постепенно.

Министерство образования Республики Беларусь  
Белорусский национальный технический университет  
Кафедра английского языка №1

И.Ю. Кипнис  
С.А. Хоменко

**ГРАММАТИЧЕСКИЕ ОСОБЕННОСТИ ПЕРЕВОДА  
АНГЛИЙСКОГО НАУЧНО-ТЕХНИЧЕСКОГО ТЕКСТА**

**Грамматический справочник**

Минск  
БНТУ  
2010

УДК 808.03(03)  
ББК 81.2 Англ. я 7  
к 42

Рецензенты:

кандидат филологических наук, доцент кафедры английского языка естественных факультетов Белорусского государственного университета *Е.З. Шевалдышева*; кандидат филологических наук, доцент кафедры иностранных языков Белорусского государственного педагогического университета им. М. Танка *Е.И. Маркосьян*.

Кипнис И.Ю.

К 42 Грамматические особенности перевода английского научно-технического текста. Грамматический справочник / И.Ю. Кипнис, С.А. Хоменко. – Минск: БНТУ, 2010. – 121 с.

ISBN 978–985–525–

Настоящее пособие представляет собой второе, исправленное и дополненное издание, предназначенное для обучения переводу аутентичной научно-технической литературы с английского языка на русский. Основное назначение пособия – способствовать выработке умений анализировать различные грамматические элементы текста и правильно переводить его.

Пособие предназначается для студентов втузов и всех, кто хочет совершенствовать свои навыки чтения, понимания и перевода оригинальной английской научно-технической литературы.

УДК 808.03(03)  
ББК 81.2 Англ. я 7

ISBN 978–985–525–

© Кипнис И.Ю.,  
Хоменко С.А., 2010  
© БНТУ, 2010



Таблица 1

## Словообразование

Префиксы	Значение	Примеры	
<b>un- dis- in- im- il- ir- non-</b>	отрицательные	unhappy to dismount inexperienced immovable illogical irresponsible non-ferrous	-несчастный -демонтировать -неопытный -неподвижный -нелогичный -безответственный -цветной
<b>re-</b>	повтор действия	to re-use to remake	-вновь (снова)использовать -переработать
<b>mis-</b>	ошибочно, неверно	to misuse	-неправильно употреблять
<b>over-</b>	сверх, чрезмерно	to overpay	-переплачивать
<b>under-</b>	недостаточно	to underpay	-недоплачивать, оплачивать низко
<b>pre-</b>	перед, ранее; предварительно	prewar to preheat	-предвоенный, довоенный -предварительно нагревать
<b>post-</b>	после	post-war	-послевоенный
<b>anti-</b>	анти-, противо-	antifriction antiphase	-антифрикционный -противофаза
<b>counter-</b>	контр-, противо-	countershaft counter-pressure	-контрпривод -противодавление
<b>inter-</b>	между, взаимно	intergranular intercoagulation	-межзернистый -взаимная коагуляция
<b>sub-</b>	под-	subprogram subscale	-подпрограмма, часть программы -подокалина
<b>super-</b>	сверх-, супер-	superfast superheat superfinish	-сверхскоростной -перегрев -суперфинишировать

## СЛОВООБРАЗОВАНИЕ

Таблица 2

Суффиксы			
существительных	прилагательных	глаголов	наречий
<b>-er (-or)</b> (указывает на действующее лицо или устройство) to supply <b>supplier</b> to heat - <b>heater</b>	<b>-ful</b> (указывает на присутствие качества) <b>care - careful</b> заботливый, осторожный	<b>-ize (-ise)</b> <b>crystal to crystallize</b> кристаллизовать (ся)	<b>-ly</b> <b>easy easily</b> легко <b>week weekly</b> еженедельно <b>first - firstly</b> во-первых
<b>-ment</b> to agree - <b>agreement</b> соглашение	<b>-less</b> (указывает на отсутствие качества) <b>care - careless</b> беззаботный, неосторожный	<b>-ify</b> <b>pure to purify</b> очищать <b>simple to simplify</b> упрощать	
<b>-ance (-ence)</b> to resist <b>resistance</b> to differ - <b>difference</b>	<b>-able (-ible)</b> to attain <b>attainable</b> достижимый to convert - <b>convertible</b> обратимый	<b>-en</b> <b>strength to strengthen</b> усиливать (ся)	
<b>-ness</b> <b>brittle - brittleness</b> хрупкость	<b>-ant (-ent)</b> to resist - <b>resistant</b> сопротивляющийся to differ - <b>different</b> различный		
<b>-ion (-ation, -tion, -sion, -ssion)</b> to connect - <b>connection</b> соединение to transmit - <b>transmission</b> передача	<b>-ous</b> <b>danger - dangerous</b> опасный		
<b>-ship</b> <b>leader - leadership</b> руководство	<b>-ive</b> to act - <b>active</b> деятельный		
<b>-ity (-jty)</b> productive - <b>productivity</b> производительность	<b>-ic</b> <b>base - basic</b> основной		
<b>-ability (-ibility)</b> machinable - <b>machinability</b> обрабатываемость	<b>-al</b> <b>centre - central</b> центральный		
<b>-ure (-ture, -sure, -ssure)</b> to press - <b>pressure</b> давление			

### **Словопроизводство при помощи изменения места ударения.**

Формы многих существительных совпадают с формами глаголов, но отличаются от них ударением – существительные имеют ударение на первом слоге, а соответствующие им глаголы на втором:

'increase [            ] (увеличение) – to increase [            ] (увеличивать)

'export [            ] (экспорт) – to export [            ] (экспортировать)

### **Словопроизводство при помощи чередования звуков.**

Многие существительные и глаголы, образованные от одного корня, различаются чередованием последнего согласного звука, который является глухим в существительном и звонким в глаголе. При этом в ряде случаев наблюдается чередование корневого гласного звука и изменение написания слова:

use [            ] (употребление) – to use [            ] (употреблять)

life [            ] (жизнь) – to live [            ] (жить)

loss [            ] (потеря) – to lose [            ] (терять)

### ***I. Переведите на русский язык, обращая внимание на префиксы:***

- a) to connect – to disconnect, to assemble – to disassemble, measurable – immeasurable, movable – immovable, probable – improbable, essential – non-essential, productive – non-productive, accuracy – inaccuracy, active – inactive, rational – irrational, responsible – irresponsible, legal – illegal;
- b) pressure – overpressure – underpressure, to work – to underwork – to overwork; to heat – to preheat – to overheat – to underheat; to set – to reset – to preset – to misset; to produce – to reproduce – to overproduce – to underproduce; to calculate – to miscalculate – to recalculate; to apply – to misapply; worker – co-worker, author – co-author; existence – co-existence; action – interaction; dependent – interdependent.

## **II. Переведите производные слова:**

a)	to equip	– оборудовать	equipment	–
	to govern	– управлять	government	–
	to compress	– сжимать	compression	–
	to produce	– производить	production	–
	brittle	– хрупкий	brittleness	–
	hard	– твердый	hardness	–
	resistant	– сопротивляющийся	resistance	–
	to depart	– уезжать	departure	–
b)	to work	– работать	worker	–
	to supply	– поставлять	supplier	–
	to use	– использовать	user	–
	to make	– делать	maker	–
	to heat	– нагревать	heater	–
	to cool	– охлаждать	cooler	–
	to change	– менять	changer	–
c)	to change	– изменять	changeable	–
	to measure	– измерять	measurable	–
	end	– конец	endless	–
	shape	– форма	shapeless	–
	care	– забота	careful	–
	doubt	– сомнение	doubtful	–
	dimension	– размер	dimensional	–
	economy	– экономика	economic	–
	danger	– опасность	dangerous	–
	to resist	– сопротивляться	resistant	–
d)	hard	– твердый	harden	–
	wide	– широкий	widen	–
	acid	– кислый	acidify	–
	simple	– простой	simplify	–
	sympathy	– сочувствие	sympathize	–

## **III. Определите часть речи:**

intensify, camless, weakness, connector, lubrication, adjustment, axial, strengthen, obtainable, normalize, slowly, mixture, governor, hopeful, numerous,

equalize, specify, dependent, convertible, deepen, helpless, influential, displacement.

**Таблица 3**

Личные местоимения				Притяжательные местоимения			
Именительный падеж		Объектный падеж		Присоединительная форма		Абсолютная форма	
I	я	me	меня, мне...	my	мой	mine	
He	он	him	его, ему...	his	его	his	
She	она	her	ее, ей...	her	ее	hers	
It	он, она, оно (обозначает неодушевлен- ный предмет)	it	его, ему... ее, ей	its	его, ее	its	
We	мы	us	нас, нам...	our	наш	ours	
You	ты, вы	you	тебя, тебе; вас, вам	your	твой, ваш	yours	
They	они	them	их, им...	their	их	theirs	
<i>всегда подлежащее в предложении</i>		<i>всегда дополнение в предложении, отвечает на вопросы косвенных падежей</i>		<i>предшествует существительному как определение, отвечает на вопрос "чей?"</i>		<i>никогда не сопровождается существительным</i>	

Nick is an engineer. **He** works at a factory.

**He** showed **her** a new book.

**He** showed **her his** new book.

**I** haven't got a dictionary. Can you give **me yours**?

**I. Выберите правильную форму местоимения:**

- a) (We, us) are in the laboratory. There are some students here. There are computers in front of (they, them, its). Let (us, we) start (our, us) work. The laboratory works are in front of (us, we);

- b) Helen is a student. (She, her) is in (her, she) fourth year. Next year (she, her) will submit (her, she) degree project;
- c) Nick is (our, we) monitor. Now he is sitting behind (me, I). (He, him) is (me, my) friend. (Our, us) students like (he, him) very much;
- d) Minsk is the capital of the Republic of Belarus. (It, she) is a large, beautiful city. (Its, it) streets are wide and clean. (Its, her) parks are large and beautiful too. We like (our, us) city very much;
- e) Mathematics is very difficult for (us, our). But (us, our) lectures in mathematics are very interesting. (We, us) are always present at these lectures.

**II. Заполните пропуски личными местоимениями:**

1. ... studies at the University.
2. ... are full-time students.
3. ... go into their classroom and sit down at the tables.
4. "Does ... sometimes meet his friends at the office?" – "Yes, ... does".
5. ... have our English in the morning.
6. ... does not speak English to her teacher.
7. ... do not learn English, ... learn French.
8. Do ... have lessons in the morning?
9. "What do ... usually read in the class?" – "... usually read our text-book".
10. ... take exams twice a year.

**III. Заполните пропуски местоимениями:**

1. My sister knows English well. ... often do my homework with ...
2. When the teacher entered the laboratory, the students were waiting for ... .
3. Have you see this film? – Yes, ... have, ... saw ... two days ago.
4. Is he going to speak to ... about his new work?
5. Take these texts and translate ... well.
6. I know this girl, ... studies with ... .
7. Our friend is good at mathematics. ... often ask ... to help ... .

#### ***IV. Заполните пропуски притяжательными местоимениями:***

1. Tell him not to forget ... ticket.
2. Whose books are those? Are they ... or ... ?
3. Give them ... dictionary, they have left ... at home.
4. We have taken ... dictionaries, has she taken ... ?
5. This does not look like ... book, it must be ... .
6. We are engineers. ... friends are engineers, too.
7. What are ... names? – ... names are Nick and Jack.
8. When I was away in the South on holiday, I met a friend of ... and we talked a lot about you.
9. We met an old friend of ... in the library.

#### ***V. Переведите на английский язык:***

1. Тема лекции - «Интернет и его использование в нашем университете».
2. Попросите их придти сюда после занятий. Я хочу объяснить им их ошибки в грамматических тестах.
3. Можно мне пользоваться сегодня вашим учебником, Я оставил свой дома.
4. Она рассказала мне вчера о своей поездке в Лондон.
5. Это очень интересный журнал. Дайте мне его, пожалуйста.
6. У них не будет урока английского языка сегодня, так как их преподаватель болен.
7. Мой друг – студент, он учится на первом курсе.
8. Один из его друзей поступил в технический университет в прошлом году.
9. Я прошу тебя объяснить мне это правило еще раз.
10. Расскажите нам о вашем университете, о его факультетах.
11. Мы очень любим свой город, его улицы и парки.

Таблица 4

Местоимения *many, much, few, little*

Исчисляемые существительные (одушевленные и неодушевленные)			Неисчисляемые существительные		
many	<i>много</i>	engineers plants	much	<i>много</i>	water work
few	<i>мало</i>		little	<i>мало</i>	
a few	<i>немного, несколько</i>		a little	<i>немного</i>	

Таблица 5

## Неопределенные и отрицательные местоимения

some	<i>некоторый, какой-нибудь, (перед исчисляемым существительным), немного (перед неисчисляемым существительным)</i>	somebody, someone	<i>кто-то, кто-нибудь</i>
any	<i>какой-нибудь, всякий, любой</i>	something anybody, anyone	<i>что-то, что-нибудь кто-нибудь, всякий</i>
no	<i>никакой</i>	anything nobody, no one nothing	<i>все, что-нибудь никто ничто</i>

Местоимения **some**, **any** обычно служат определением к существительному, которое всегда стоит без артикля.

Местоимение **some** обычно употребляется в утвердительных предложениях:

He asked me some questions.

*Он задал мне несколько вопросов.*

Местоимение **any** обычно употребляется в вопросительных и отрицательных предложениях:

Are there any new magazines in the library?

*В библиотеке есть (какие-нибудь) новые журналы?*

Today we do not have any lessons but mathematics.

*Сегодня у нас нет никаких занятий кроме математики.*



В утвердительных предложениях перед исчисляемыми существительными **any** означает любой, всякий.

You can get any book you like in our library.

*В нашей библиотеке вы можете взять любую книгу, какую захотите.*

**I. Заполните пропуски местоимениями *tuch, many*.**

1. How ... sheets of paper do you want?
2. How ... time does it take you to get to the University?
3. He does not have ... friends among the students of his group.
4. He has ... friends.
5. He has got ... work to do.
6. Have you invited ... people to the party?
7. He translates very ... letters into English.
8. The teacher gives us ... homework.
9. My friend reads ... .

**II. Заполните пропуски местоимениями *little, a little, few, a few*.**

1. He had very ... friends.
2. Let him think ... .
3. I have been to ... lectures here and liked them very much.
4. You know ... German, don't you?
5. My friend is coming to London in ... days.
6. I don't know any French, but I like to hear it. Please say ... words in French.
7. I have got ... free time today.
8. We can read English ... .
9. I have got ... letters on my desk today.

**III. Переведите на английский язык, обращая внимание на употребление *tuch, many, little, a little, few, a few*.**

1. У вас много работы сегодня?

2. Вы читали много книг по этой проблеме?
3. Он много читал по этой проблеме.
4. Мало написано по этому вопросу.
5. Разрешите мне сказать несколько слов о нашем Университете.
6. У нас слишком мало времени для того, чтобы обсуждать все эти вопросы сегодня.
7. Он немного знает английский язык.
8. Подождите немного, я вернусь через несколько минут.
9. Мои друзья читают много английских книг.
10. Мы очень много читаем и очень мало пишем в аудитории.

**IV. Заполните пропуски местоимениями *some, any*.**

1. Have you got ... friends among the students of your group?
2. I haven't got ... questions.
3. Please take ... magazine you like.
4. I don't think we have got ... time to discuss this problem.
5. We have made ... interesting experiments.
6. My friends know ... foreign languages.
7. Can you give me ... more information?

**V. Переведите на английский язык, обращая внимание на употребление местоимений *some, any*.**

1. Есть ли иллюстрации в этом журнале?
2. В этом журнале нет иллюстраций.
3. Я принес вам почитать интересные книги.
4. Есть ли английские журналы в вашей библиотеке?
5. Некоторые студенты первого курса уже сдали экзамен по математике.
6. Некоторые из книг, которые вы мне дали, очень интересные, а некоторые – нет.
7. Вы знаете какой-нибудь иностранный язык?
8. Вы можете достать эту книгу в любой библиотеке.

## Основные формы глагола

V <sub>1</sub> инфинитив	V <sub>2</sub> Past Simple	V <sub>3</sub> Past Participle	V <sub>4</sub> Participle I	
to use	<u>used</u>	<u>used</u>	using	правильный глагол
to get to know	got knew	got known	getting knowing	неправильные глаголы

## Личные и неличные формы глагола.

Формы глагола делятся на:

- Личные**, которые выражают лицо, число, время, залог и наклонение. Они служат в предложении сказуемым и при них всегда имеется подлежащее;
- Неличные**, которые выражают действие **без** указания лица, числа и наклонения; они могут быть только частью сказуемого или выполнять функции других членов предложения. К ним относятся инфинитив, причастие и герундий.

## I. Дайте основные формы следующих глаголов.

to provide, to work, to make, to speak, to come.

## II. Прочтите а) первые формы; б) вторые формы; в) третьи формы.

writing, written, wrote, teach, taught, go, gone, went, be, was, been, had, have, seen, see, saw.

## III. Определите личные и неличные формы глагола.

to be studied, is studied, studies, to have studied, had studied, are studying, to be studying, to have been studied, has been studied.

Функции глагола **to be**

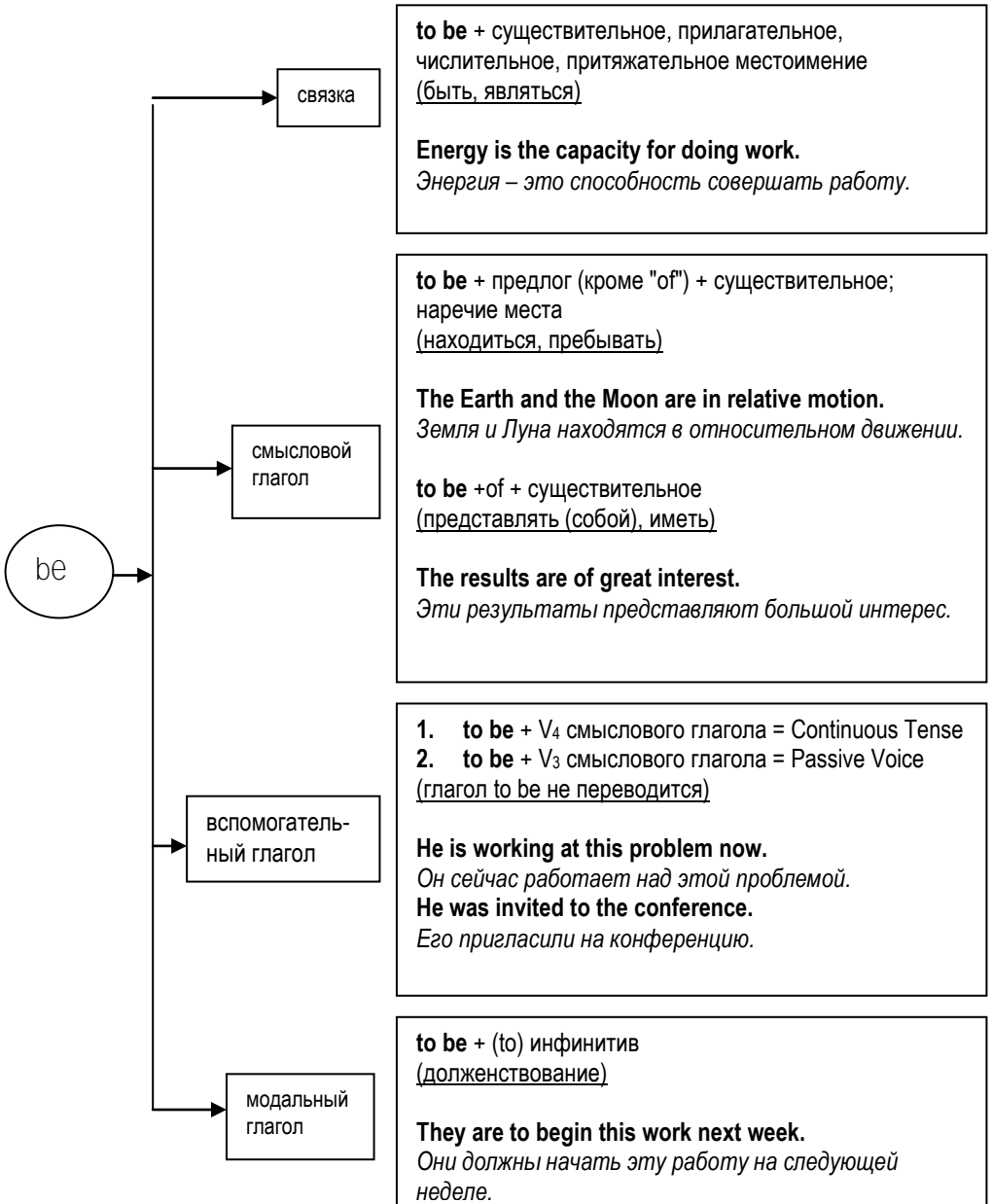

**I. Выберите правильную форму глагола to be.**

1. Our technical University (was, were) founded in 1920.
2. Research work (are, is) being done on the most urgent scientific problems.
3. All of us (was, were) provided with hostel accommodation.
4. Great success (was, were) achieved in this sphere.
5. The new laboratory (am, is) equipped with up-to-date machinery.
6. These machines (was, were) produced last year.
7. This fact (was, were) mentioned in his report.
8. My friend (is, are) a qualified engineer.

**II. Определите функцию глагола to be в следующих предложениях.**

1. The point of application of the force is to be changed.
2. The Earth and the Moon are in relative motion.
3. Mechanical and thermal equilibrium is the natural state of all bodies.
4. In the experiment both bodies are to move with acceleration.
5. It is to be noted that force is a vector quantity.
6. At present only a little part of solar energy is being used directly.
7. The change of velocity in a unit of time is called acceleration.
8. Sometimes it is difficult to stop an object when it is in motion.
9. Force, work, energy and power are studied in physics.
10. The next problem was to find the suitable instruments for the experiment.

**III. Поставьте все возможные вопросы к следующим предложениям.**

1. My friend and I are first-year students.
2. We are students of the technical University.
3. My friend and I are full-time students.
4. My elder brother is a part-time student.
5. He is in his third year.

6. We are all students of the Department of Mechanical Engineering.

**IV. Переведите следующие предложения на английский язык, используя глагол "to be".**

- a) 1. Я – студент технического университета.  
2. Я учусь на первом курсе.  
3. Я учусь на дневном отделении.  
4. Мой брат занимается на заочном отделении.  
5. Он на третьем курсе.  
6. Мы с братом учимся на одном факультете – машиностроительном.  
7. Наш факультет – один из самых больших в университете.
- b) 1. Моя курсовая работа очень интересная, но сложная.  
2. Мой друг сейчас в Англии. Он знает английский язык лучше меня.  
3. Два года назад я был в Москве.  
4. Я очень занят сейчас.  
5. Его нет, он на лекции в ауд. 306.

**Оборот There is/are.**

(есть, находится, имеется, существует)

Этот оборот служит для выражения присутствия (отсутствия) в определенном месте еще неизвестного собеседнику или читателю лица или предмета. Данный оборот стоит в начале предложения, за ним следует подлежащее, выраженное существительным, т.е. имеет место обратный порядок слов (инверсия).

Если в предложении с оборотом **There is/are** имеется обстоятельство места, то перевод начинается с этого обстоятельства.

There are deposits of diamonds in the country.

*В этой стране есть запасы алмазов.*



При отсутствии обстоятельства перевод предложения начинается с самого оборота, т.е. со слов “существует”, “имеется”.

There are different forms of energy

*Существуют различные формы энергии.*

После оборота There is/are исчисляемое существительное в единственном числе употребляется с неопределенным артиклем, а исчисляемое существительное во множественном числе и неисчисляемые существительные употребляются с местоимениями **some, any**.

There is a computer on the desk.

*На письменном столе компьютер.*

There are some (many) students in the library.

*В библиотеке несколько (много) студентов.*

There is some water in the jug.

*В кувшине есть немного воды.*

Примечание: **there** в конструкции *there is/are* теряет свое лексическое значение и отдельно не переводится.

### **I. Выберите правильную форму глагола:**

1. There (are, is) lots of colleges and higher educational establishments in Belarus.
2. Our University (is, are) very large. There (is, are) more than ten thousand students in it.
3. There (are, is) ten departments in it.
4. There (are, is) a lot of class-rooms and laboratories in our University.
5. On the second floor there (are, is) two large reading halls.
6. There (are, is) many magazines and newspapers in them.
7. There (are, is) a library on the first floor.
8. There (are, is) a cloak-room on the ground floor.

### **II. Выберите правильную форму.**

1. (it, there) is autumn.



2. (they, there) are three months in autumn.
3. (they, there) are September, October and November.
4. (it, there) is warm today.
5. (it, there) is no sun in the sky.
6. (they, there) are few clouds in the sky.
7. (there, it) is a nice park near my house.
8. (there, they) are many trees there.
9. (they, there) are green.
10. (they, there) are many children in the park today.

**III. Поставьте следующие предложения в вопросительную форму.**

1. There are many sunny days in autumn.
2. There was much snow in winter last year.
3. There are some students in the classroom.
4. There are some English books on the table.

**IV. Переведите следующие предложения на английский язык.**

1. В университете много иностранных студентов. В университете много иностранных студентов?
2. В нашем техническом университете десять факультетов. Сколько факультетов в вашем университете?
3. В вашем университете есть вечернее отделение? – Нет, в нашем университете нет вечернего отделения.
4. В университете много хорошо оборудованных лабораторий. В университете много хорошо оборудованных лабораторий? Сколько лабораторий в университете?
5. В библиотеке много книг по всем специальностям. В библиотеке много книг? Какие книги есть в библиотеке?
6. В читальном зале будет новая выставка книг по информатике. Какая новая выставка будет в читальном зале?

7. В нашем компьютерном классе один компьютер преподавателя и пятнадцать компьютеров для студентов.

Таблица 8

### Функции глагола to have

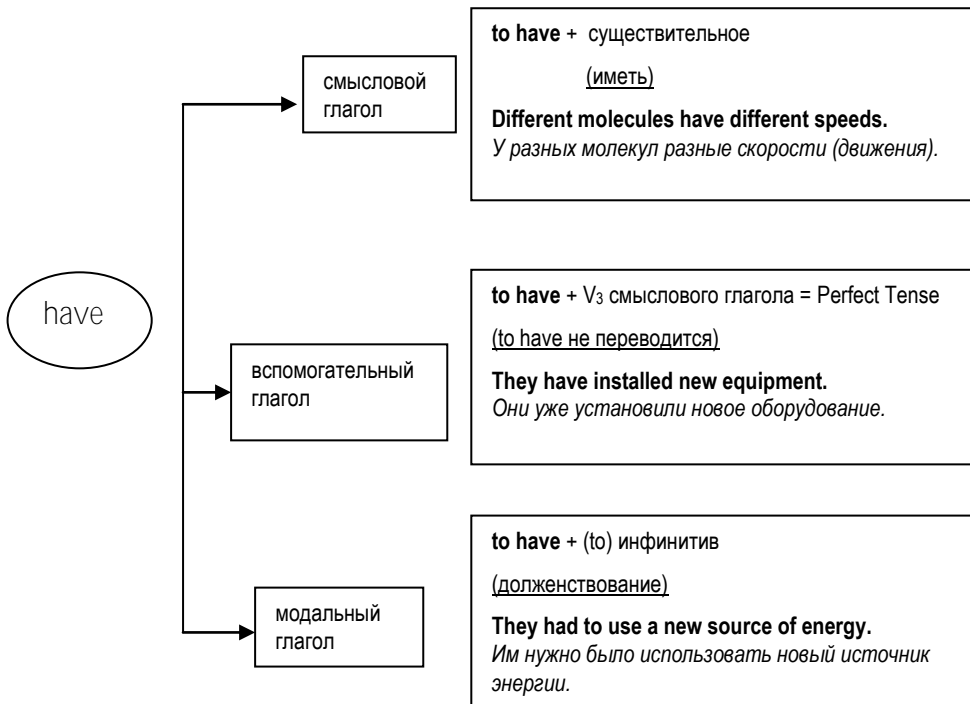

#### I. Выберите правильную форму.

- a) 1. (They, she) have a lot of friends at the University  
2. (They, he) has passed all the exams.  
3. (The body, the bodies) has been lifted to the necessary height.

4. (Carbon atom, carbon atoms) have the ability to be linked to each other.
- b)
  1. According to the time-table students (has, have) three lectures today.
  2. Our University (has, have) ten departments.
  3. Radical changes (has, have) taken place in science and education.
  4. Belarus (has, have) a lot of modern industrial enterprises.
  5. The device (has, have) already been tested.
  6. The point of application of the force (has, have) to be changed.

**II. Определите функцию глагола to have в следующих предложениях.**

1. They had to fulfil the plan in time.
2. The production of the plant has increased by twenty times.
3. The rate of evaporation has to be increased.
4. Different molecules have different speeds.
5. Bodies in the state of thermal equilibrium have the same temperature.
6. Accumulators of solar energy have been discovered comparatively recently.
7. Every body has a center of gravity.
8. The caloric theory of heat had existed up to the middle of the 19th century.
9. Engineers have to give due attention to the problem in question.
10. The change of temperature has to be evaluated.

**III. Переведите следующие предложения на английский язык.**

1. Мы должны закончить испытания на этой неделе.
2. В прошлом году у нас было много лекций.
3. Каникулы у студентов два раза в год.
4. Ты должен выполнить свою курсовую работу в срок.
5. Я должен был вернуть эту книгу в библиотеку на прошлой неделе.

6. Вчера у меня был очень интересный разговор с профессором.
7. У него есть очень интересные книги по истории нашей страны.
8. У меня не было времени навестить его вчера.

### Страдательный залог

#### to be + Past Participle смыслового глагола



*показатель времени, лица и числа*

В английской научной и технической литературе личные формы глагола очень часто употребляются в страдательном залоге, который можно переводить на русский язык:

- 1) возвратным глаголом с окончанием "-ся"  
One form of energy is transformed into another.  
*Одна форма энергии превращается в другую.*
- 2) неопределенно-личным предложением с глаголом в третьем лице множественного числа действительного залога  
This system of measurement is called the metric system.  
*Эту систему измерения называют метрической системой.*
- 3) глаголом "быть" (в прошедшем или будущем времени) и краткой формой причастия страдательного залога  
The law of conservation of matter was discovered by Lomonosov.  
*Закон сохранения материи был открыт Ломоносовым.*

#### Примечания:

1. При переводе английских предложений со сказуемым в страдательном залоге часто используется обратный порядок слов, т.е. русское предложение начинается со сказуемого.

New programming languages have been developed.

*Были разработаны новые языки программирования.*

2. Если за сказуемым в страдательном залоге стоит дополнение с предлогом "by" (обозначает лицо или предмет, воздействующее на подлежащее) или "with" (обозначает инструмент или орудие труда), то это дополнение можно переводить:

а) творительным падежом при сохранении формы страдательного залога сказуемого;

б) именительным падежом, при этом сказуемое английского предложения передается глаголом в действительном залоге.

Three basic laws of motion were discovered by Newton.

*Три основных закона движения были открыты Ньютоном.*

*Ньютон открыл три основных закона движения.*

3. Подлежащее английского предложения при сказуемом в страдательном залоге можно переводить существительным или местоимением как в именительном, так и в косвенном падеже (как правило, винительном или дательном).

The scientists were offered new themes for research.

*Ученым предложили новые темы для научной работы.*

He is asked to show the results of his experiment.

*Его просят показать результаты эксперимента.*

4. Если за сказуемым в страдательном залоге стоит предлог, не относящийся к последующим словам, то при переводе на русский язык этот предлог ставится перед подлежащим.

II

This law | is often referred to | in physics.

*На этот закон часто ссылаются в физике.*

К наиболее часто употребляемым в страдательном залоге глаголам, требующим предложного дополнения, относятся:

to act on (upon)	– действовать на
to depend on	– зависеть от
to insist on	– настаивать на
to refer to	– ссылаться на
to rely on (upon)	– полагаться на
to send for	– посылать за
to speak about	} говорить о
to talk about	
to think of	– думать о
to work on/at	– работать над

5. При переводе страдательного залога английских переходных глаголов, которым в русском языке соответствуют глаголы, принимающие предложное дополнение, предлог ставится перед словом, которое в английском предложении является подлежащим.

The results were affected by the presence of impurities.

*На результаты повлияло присутствие примесей.*

**👉 Запомните следующие переходные глаголы:**

<b>to address (smb.)</b>	обращаться к кому-либо
<b>to affect (smb., smth.)</b>	влиять, воздействовать на кого-либо, что-либо
<b>to follow (smb., smth.)</b>	следовать, следить за кем-либо, чем-либо; следовать чему-либо
<b>to influence (smth., smb.)</b>	влиять, оказывать воздействие на что-либо, кого-либо
<b>to watch (smth., smb)</b>	следить за чем-либо, кем-либо, наблюдать что-либо

***I. Переведите следующие предложения, сравнивая залогом сказуемого.***

1. The chemist has obtained pure oxygen. Several organic compounds were obtained last year.
2. In kinematics motion is described with respect to speed, time and distance. Kinematics describes motion with respect to speed, time and distance.
3. We can divide applied mechanics into two parts – statics and dynamics. Applied mechanics can be divided into two parts – statics and dynamics.

***II. Переведите следующие предложения, обращая внимание на способы передачи страдательного залога:***

1. The vector is drawn perpendicular to the plane of the couple.
2. In physics energy is defined as the capacity to do work.
3. The experiment was made for the second time.
4. The University laboratories are equipped with up-to-date mechanisms and devices.
5. The molecular kinetic theory of heat and the kinetic theory of gases were demonstrated by Lomonosov M.V.
6. Heat is developed when compressing a gas.
7. On May 24, 1844 the first long-distance message was sent by telegraph for 64 kilometers.

***III. Переведите следующие предложения на русский язык, обращая внимание на особенности передачи подлежащего при сказуемом в страдательном залоге.***

1. He was asked to take part in the conference.
2. They were promised every support in their research work.
3. The book will be translated into English and German

4. Our scientists and professor were invited to the international conference in London.
5. The students are taught to carry out a research.
6. They have been shown new laboratory equipment.

**IV. Переведите следующие предложения с английскими**

**a) *непереходными* и b) *переходными* глаголами. Подберите правильные русские эквиваленты.**

- A.
1. The new instructions have been sent for.
  2. Lomonosov's law of the conservation of matter is often referred to.
  3. The problem of atmospheric electricity was much worked at.
  4. Some of the data obtained cannot be relied upon.
  5. When the molecules of a good insulator are acted upon by an electric field, there is a motion of electrons due to this field.
  6. Action and reaction are never spoken about as balanced forces since they do not act on the same body.
  7. Many materials now used in everyday life were not even thought of thirty-fourty years ago.
- B.
1. The development of Russian science was greatly influenced by M.V. Lomonosov.
  2. The properties of metals are strongly influenced by even small admixtures of other metals.
  3. The point of equilibrium is greatly influenced by the temperature.
  4. Laboratory experiments were followed by industrial applications.
  5. The discovery of the electron was followed by the investigation into its properties.
  6. Annealing is followed by very slow cooling.



**V. Переведите следующие предложения на английский язык, используя страдательный залог.**

- A.
1. Дома сейчас строят очень быстро.
  2. Их попросили написать контрольную работу.
  3. Такие вопросы, как правило, обсуждаются после работы.
  4. В этом журнале печатаются очень интересные статьи.
  5. Радио было изобретено А. Поповым в 1895 году.
  6. Ему дадут все необходимые книги и журналы в понедельник.
  7. Ваши документы будут подписаны на следующей неделе.
- B.
1. В вашем городе строится много домов?
  2. Когда была отправлена эта телеграмма?
  3. Куда была отправлена эта телеграмма?
  4. Кем была отправлена эта телеграмма?
  5. Какие вопросы обычно обсуждают на собрании?
  6. Какие предметы изучают на первом курсе?
  7. Какие иностранные языки преподают в вашем университете?

**Модальные глаголы**

*Модальными* называются глаголы, которые выражают не действие, а отношение говорящего к действию, выраженному последующим инфинитивом, т.е. возможность, вероятность или необходимость совершения действия. Модальные глаголы имеют следующие особенности:

1. Смысловой глагол стоит после них без частицы "to".  
New technologies must be used.
2. Вопросительную и отрицательную формы образуют без помощи вспомогательного глагола.  
Can you solve the problem?  
I cannot solve this problem.

3. Не изменяются по лицам и числам.

He  
They } must complete the work on the road in time.

4. Не имеют неличных форм: инфинитива, причастия, герундия.

5. Не имеют формы будущего времени, а глагол "must" не имеет и формы прошедшего времени. Для восполнения недостающих форм модальные глаголы имеют равнозначные словосочетания, которые называются эквивалентами модальных глаголов.

### Таблица модальных глаголов и их эквивалентов

Модальный глагол	Значение	Present Simple	Past Simple	Эквивалент
<b>can may</b>	возможность, способность совершения действия	<b>can may</b>	<b>could might</b>	<b>to be able (to) to be allowed (to)</b>
<b>must</b>	долженствование, т.е. необходимость совершения действия	<b>must</b>	--	<b>to be (to) to have (to)</b>
<b>ought (to) should</b>	долженствование (для выражения морального долга)	<b>ought (to) should</b>	-- --	-- --

### Сочетание модальных глаголов с инфинитивом в страдательном залоге

В научно-технической литературе часто встречается сочетание модальных глаголов **can, may, must** с инфинитивом смыслового глагола в страдательном залоге, которое следует переводить:

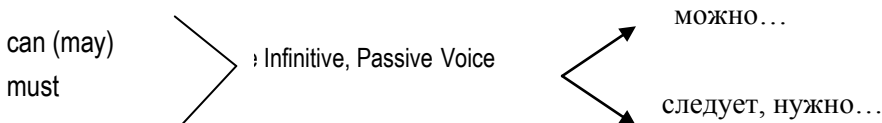

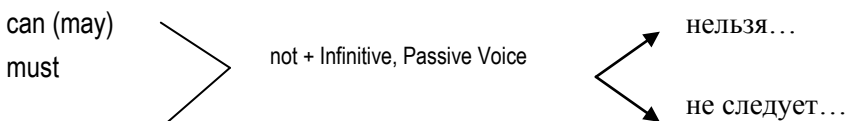

Work can be expressed in any units of force and distance.

*Работу можно выразить в любых единицах силы и расстояния.*

The new equipment must be tested.

*Следует проверить новое оборудование.*

This device cannot be used, it is out of order.

*Этот прибор нельзя использовать, он не исправен.*

### **Сочетание модальных глаголов с перфектным инфинитивом**

**must, may, might + Perfect Infinitive** выражает вероятное предположение в совершении действия, относящегося к прошлому, и переводится словами "возможно", "вероятно", "видимо", "должно быть", "следовало бы".

These scientists may have already obtained the necessary data.

*Эти ученые, возможно, получили необходимые данные.*

All the preparations for the experiment must have been completed long ago.

*Все приготовления к эксперименту, должно быть, были давно закончены.*

**can (could) + Perfect Infinitive** в отрицательной или вопросительной форме выражает удивление, категорическое отрицание, сомнение по поводу того, что действие, выраженное инфинитивом, действительно совершилось. Может переводиться словами "не может быть", "разве".

He cannot have done it.

*He может быть, чтобы он это сделал.*

**I. Поставьте следующие предложения в а) Past Simple,  
b) Future Simple.**

Example: He must take an exam in mathematics.  
He had to take an exam in mathematics.  
He will have to take an exam in mathematics.

1. Robots must move in the same way as the human body.
2. They must complete all the tests as soon as possible.
3. He must follow the instructions.
4. The procedure of the experiment must be described in detail.

Example: One can make a computer more powerful.  
One could make a computer more powerful.  
One will be able to make a computer more powerful

1. A robot can modify its actions to suit the new situation.
2. Many elements can form compounds with carbon.
3. A compound can be decomposed into any other substances.

Example: He may use a different method in solving this problem.  
He might use a different method in solving this problem.  
He will be allowed to use a different method in solving this problem.

1. They may assess the adequacy of protective measures.
2. After school young people may enter universities or colleges.
3. This article may be translated with a dictionary.

**II. Переведите предложения на русский язык, обращая внимание на модальные глаголы.**

- A.**
1. Forces can exist without motion, but motion is almost invariably associated with a force.
  2. We cannot apply Newton's Third Law of Motion to a force acting at a distance.
  3. A robot must obey the orders that are given by human beings.

4. They had to know the mechanical properties of a new alloy.
  5. In order for a robot to carry out a particular task it has to be given a program, a list of instructions which are to be stored in its computer memory.
  6. To convert chemical energy into electrical one we must make use of an electric cell.
  7. We have to use an insulator to prevent electrical loss.
  8. A machine will be able to do this work in a much shorter time.
- B.**
1. Heat may be converted into mechanical energy.
  2. Newton's Third Law of Motion cannot be applied to a force acting at a distance.
  3. Brakes must be applied to stop a train in case of emergency.
  4. Therefore, the entire technological and economic effect has to be evaluated.
  5. The individual recommendations should not be viewed separately.
  6. Radiation may, however, be transmitted through any medium that does not absorb it.
  7. An opposing force must be applied to stop a moving body.
  8. The flow of electrical charge can be used to great advantage for power distribution because power can be generated wherever suitable and used wherever required, even hundreds of kilometers away from the point of generation.
- C.**
1. He might have known that the weight of a body is usually denoted by the letter "P".
  2. One of the most interesting applications of these machines may have been in underwater work.
  3. This plant must have been put in operation long ago.
  4. He couldn't have broken the instrument during the experiment.

5. He couldn't have known that light and radio waves are of a similar nature.
6. All the preparations must have been completed long ago.
7. They must have paid more attention to the problem of corrosive wear.

**III. Переведите следующие предложения на английский язык, используя модальные глаголы и их эквиваленты.**

1. Не может быть, чтобы она уже решила все уравнения.
2. Можно мне взять твой словарь?
3. Вчера мне пришлось повторить эксперимент.
4. Мне придется сдать эту книгу в библиотеку.
5. Он, наверное, уже сделал перевод, и, может быть, собирается смотреть телевизор.
6. Нельзя пользоваться словарем во время контрольной работы.
7. Эту книгу можно купить в любом магазине.
8. Им, вероятно, сообщили об этом несколько дней тому назад.
9. Эта статья, должно быть, была написана еще в годы войны.
10. Я должен был завершить эту работу вчера, но не смог этого сделать.
11. Эти сведения нельзя было нигде получить.
12. В каком часу вы должны быть в университете завтра?
13. Этот вопрос придется рассматривать еще раз.
14. Эту работу нельзя сделать в такой короткий срок.
15. Все эти цифры можно найти в справочнике.

Таблица 9

## Видо-временные формы английского глагола в активном залоге.

	Present	Past	Future
<b>Simple</b>	ask (he, she, it) asks	asked	shall ask will ask
<b>Continuous</b> to be + V <sub>4</sub> смыслового глагола	am asking is asking are asking	was asking were asking	shall be asking will be asking
<b>Perfect</b> to have + V <sub>3</sub> смыслового глагола	have asked has asked	had asked	shall have asked will have asked
<b>Perfect Continuous</b> to have been + V <sub>4</sub> смыслового глагола	have been asking has been asking	had been asking	shall have been asking will have been asking

Констатация факта совершения действия в настоящем, прошедшем или будущем времени без указания на его длительность или законченность

Действие, которое происходит, происходило или будет происходить в определенный момент речи

Действие, совершенное к определенному моменту в настоящем, прошедшем или будущем

Действие, находящееся в процессе целый период времени до какого-то момента; оно может быть закончено к данному моменту, а может продолжаться

*Таблица 10*

**Видо-временные формы английского глагола в страдательном залоге**

	<b>Present</b>	<b>Past</b>	<b>Future</b>
<b>Simple</b> to be + V <sub>3</sub> смыслового глагола	am is are asked	was were asked	shall will be asked
<b>Continuous</b> to be being + V <sub>3</sub> смыслового глагола	am is are being asked	was were being asked	-
<b>Perfect</b> to have been + V <sub>3</sub> смыслового глагола	have has been asked	had been asked	shall will have been asked



**I. Найдите сказуемое в следующих предложениях, определите его время и залог, переведите предложения.**

1. The endless number of chemical changes are taking place in nature.
2. After the experiment had been finished the assistant compared the results.
3. The Fahrenheit temperature scale is commonly used in the United States and in England.
4. The specialists will have installed the new equipment in the machine shop by the end of the week.
5. Lomonosov demonstrated both the molecular-kinetic theory of heat and the kinetic theory of gases.
6. The latest achievements in engineering were being illustrated by diagrams and figures when I entered the lecture room.
7. Lomonosov had discovered the law of the conservation of matter many years before Lavoisier.
8. This problem is discussed in the book that was published some years ago.
9. The professor has been working on his book for a year.
10. Inertia and friction will be discussed and explained later on.

**II. Выберите правильную форму.**

1. Yesterday when the teacher (entered, enters) the classroom, the students (were sitting and writing, are sitting and writing). They (have been writing, had been writing) their test in mathematics for an hour already. Two students (have finished, had finished) the work and (are looking, were looking) it through.
2. Scientists (have solved, had solved, solved) this interesting problem by the end of the 19th century.
3. Every year our scientists (solve, are solving, have solved) a lot of important scientific problems.
4. Listen! The student (is making, makes, has made) a report.

5. Everything is ready for the experiment, the two substances (are mixed, have been mixed, were mixed) just.
6. We usually (are measuring, have measured, measure) physical quantities with pinpoint accuracy.
7. Our great demands for power (are met, will be met, will have been met) by nuclear power in the next 30 years.
8. The neutron (had been discovered, has been discovered, was discovered) in 1932.
9. In this section we (defined, define, have defined) the quantities we need for our work.
10. They (are making, have made, have been making) a lot of experiments for the last two years and (prove, proved, have proved) the theory.
11. We (solved, have solved, have been solving) the problem for a long time and at last (solved, are solving, have solved) it.

### ***III. Переведите на английский язык.***

2. 1. На каком факультете ты занимаешься?  
2. Тебе нравится твоя будущая специальность?  
3. Какие предметы ты изучаешь?  
4. Когда ты закончишь институт?  
5. Куда ты пойдешь работать?  
6. Сколько экзаменов ты сдавал в последнюю сессию?  
7. Ты сдал все экзамены?  
8. Какие оценки ты получил?  
9. Твой друг тоже учится в институте?  
10. Твой друг получает стипендию?
2. 1. Студенты слушают лекцию по физике каждую неделю.  
2. Студенты сейчас слушают лекцию по физике.  
3. Студенты уже прослушали лекцию по физике.  
4. Вчера студенты слушали интересную лекцию по физике.

5. Вчера в течение часа студенты слушали интересную лекцию по физике.
6. На следующей неделе студенты будут слушать интересную лекцию по физике.
7. К концу недели студенты уже прослушают две лекции по физике.
8. После того как студенты прослушали несколько лекций по физике, они написали контрольную работу (to take a test).
2. 1. Над чем ты работаешь? – Я работаю над своей курсовой работой. – А я ее закончил. – Когда ты ее закончил? – Я закончил ее два дня тому назад.
  2. Она уже пришла. Она ждет тебя. Она ждет тебя уже пять минут.
  3. Послушай. На каком языке говорят эти студенты? – Они говорят по-французски.
  4. Этот университет в 1992 году подготовил около 2000 специалистов.
  5. К концу следующего года они оборудуют эту фабрику самыми современными машинами.
  6. Когда он приехал в Минск, на его улице строили институт, а больницу уже построили.
  7. Что ты делала вчера в это время?
  8. Позвони мне в пять, я буду ждать твоего звонка.
  9. Он окончил институт еще до того, как его сестра стала студенткой.
  10. Он разработает всю систему к началу эксперимента.
  11. Ты сдал уже все экзамены? – Да, я сдал их неделю назад.
  12. Интересный эксперимент проводится сейчас в нашей лаборатории. Я думаю, что он будет закончен к концу дня.
  13. Как долго профессор читает лекцию? – Он читает ее уже два часа.
  14. Завтра я не буду работать в библиотеке. – Почему? – Я буду сдавать экзамен по физике в это время.

## Структура простого повествовательного распространенного предложения.

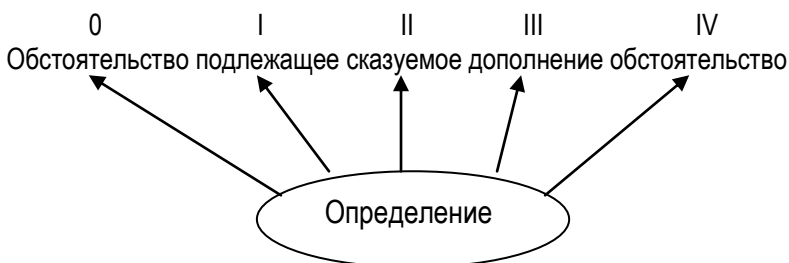

1. Присутствие подлежащего и сказуемого в предложении обязательно.
2. Определение входит в состав той группы, слово которой оно определяет. Оно может быть левым (л.о.) или правым (п.о.) по отношению к определяемому существительному.

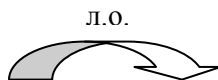

Mechanics deals with the laws of mechanical motion.

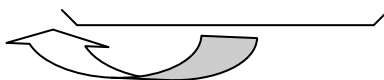

п.о.

3. Чтобы определить синтаксическую функцию слова, необходимо делать анализ предложения, который следует начинать с нахождения сказуемого. Его легко распознать по:

а) вспомогательным глаголам (в личной форме):

**to be** – am, is, are; was, were

**to have** – have, has; had

**to do** – do, does; did

**shall, will**

Mechanical energy furnished by a water wheel or an engine  
| **is converted** | by a generator into electrical energy

Because of its numerous advantages the electric motor  
| **has largely replaced** | other motive power.

This inert core | **does not contribute** | directly to the properties of the  
element, both electrical and chemical.

When the temperature of the vessel decreases, some of the steam  
| **will be condensed** | and | **will give up** | the latent heat.

б) модальным глаголам:

**can (could); may (might); must (to be (to)); to have (to); should, ought**

Chemical energy | **can be converted** | into electrical energy  
directly without going through heat.

To do so we | **must make** | use of an electric cell.

в) наречиям неопределенного времени, которые сопутствуют  
сказуемому:

**always, already, often, seldom, sometimes, usually, generally,  
commonly, never, ever...**

Thus, the current in a conductor | **always produces** | magnetic field  
surrounding or linking with the conductor.

г) подлежащему, выраженному личным местоимением в  
именительном падеже: **I, he, she, it, we, you, they**

Now we | **place** | this coil within, say, 30 cm or so of the primary.

д) беспредложному дополнению, выраженному существительным в общем падеже или личным местоимением в объектном падеже (me, him, her, it, us, you, them):

Changes of current in one circuit | induce | a *current* in another circuit.

This | **causes** | *it* to act likewise, and so on

е) второй форме неправильных глаголов:

W. Gilbert, the English physician and physicist | **wrote** | about attraction as well as repulsion in connection with his experiments on magnetism

ж) грамматическому окончанию "-s (-es)", "-ed":

This | **causes** | the next neighbouring valence electron to act likewise.

The invention of the electric cell | **opened** | the way for the use of a continuously flowing current.

Примечание:

1) окончание **-s (-es)** может быть формальным признаком существительного во множественном числе.

I	II	IV
Their <i>studies</i>	begin	in September.

2) окончание **-ed** может быть формальным признаком третьей формы (V<sub>3</sub>) правильного глагола:

I	V <sub>3,опр</sub>	II
Any gas	contained	in a vessel   exerts   pressure.

4. Каждый член предложения может быть выражен одним словом или группой слов. Группа слов, состоящая из нескольких существительных (или существительных и прилагательных), не разделенных ни предлогом, ни артиклем, ни знаком препинания, называется **ИМЕННОЙ ГРУППОЙ**. На

начало именной группы часто указывает предлог, артикль или заменяющие артикль другие определители, например, притяжательные, указательные, неопределенные или отрицательные местоимения, числительные и др. Перевод именной группы следует начинать с последнего существительного, а предшествующие существительные – определения можно переводить:

а) прилагательным;

tube **steel** – *трубная сталь*

steel **tube** – *стальная труба*

б) существительным в родительном падеже;

cylinder **head** – *головка цилиндра*

в) существительным с предлогом;

gear **steel** – *сталь для зубчатых колес*

compression **strength** – *прочность на сжатие*

г) одним термином;

track **ditch** – *кювет*

### Анализ сложного предложения

1. Сложносочиненное предложение состоит из двух или более простых предложений, которые соединяются между собой либо с помощью сочинительных союзов *and*, *but*, *or* и др., либо без них. Сложносочиненное предложение анализируется так же, как и простое предложение.

I	II	I	II
Dynamics	deals	with objects in movement	and
bodies in a state of rest,	that is, a state of equilibrium.	statics	studies

*Динамика рассматривает предметы в движении, а статика изучает тела в состоянии покоя, т.е. в состоянии равновесия.*

I II I II

The laboratory | is well equipped | , | it | has | all the necessary equipment.

*Лаборатория хорошо оборудована, в ней есть все необходимое оборудование.*

2. Сложноподчиненное предложение состоит из главного и одного или нескольких придаточных предложений. Придаточное предложение присоединяется к главному при помощи:

а) подчинительных союзов:

***because, as, if, whether, since, after, before*** и др.

Any moving object performs work *because* it is moving.

*Любой движущийся предмет выполняет работу, потому что движется.*

б) союзных слов:

***who(m), what, which, that (который), where*** и др.

Mechanics is the science *which* studies motion and forces.

*Механика – это наука, которая изучает движение и силы.*

в) бессоюзной связи (придаточные определительные и дополнительные).

Признаком бессоюзной связи придаточного определительного предложения является стык двух существительных или существительного и личного местоимения в именительном падеже.

The properties of carbon steels depend on the quantity of carbon they contain.

*Свойства углеродистых сталей зависят от количества углерода, которое они содержат.*

**Примечания:**

1) Союзные слова отличаются от союзов тем, что не только связывают придаточное предложение с главным, но и входят в состав придаточного предложения в качестве одного из его членов.



2) Предлог в конце придаточного определительного предложения относится к союзному слову, которое подразумевается.

The instrument | we are talking about | is very accurate.  
*Прибор, о котором мы сейчас говорим, очень точный.*

3) Каждое придаточное предложение занимает в главном предложении место определенного члена предложения и поэтому может быть:

а) придаточным-подлежащим;

I | II  
That work is a form of energy | is not difficult to prove.  
*То, что работа – это форма энергии, нетрудно доказать.*

б) придаточным сказуемым (именная часть). Оно стоит после глагола-связки, занимая место именной части сказуемого, и вводится союзом или союзным словом.

I | II  
The difficulty | is whether we shall be able to solve this problem.  
*Трудность заключается в том, сможем ли мы решить эту проблему.*

в) придаточным дополнительным;

I | II | III  
We | know | that there are numerous forms of energy.  
*Нам известно, что существуют многочисленные формы энергии.*

г) придаточным обстоятельственным. Оно может предшествовать подлежащему или стоять в конце сложного предложения. Как правило, такие предложения вводятся союзами и могут выполнять функции обстоятельства времени, места, условия, цели, причины.

0 | I | II | III  
When a body is capable of performing work, | it | possesses | energy.  
*Когда тело способно совершить работу, оно обладает энергией.*

	I	II	III	IV
Any moving object	performs	work	simply because it is moving.	
<i>Любой движущийся предмет выполняет работу, просто потому что он движется.</i>				

	I	II	
If an object is heated	the average speed of its molecules	will be increased.	
<i>Если предмет нагреть, то средняя скорость его молекул увеличится.</i>			

д) придаточным определительным:

	I	II	
Statics	studies	the forces that keep an object in equilibrium.	
<i>Статика изучает силы, которые удерживают предмет в равновесии.</i>			

	I	II	
The problem the scientists worked at	was of great significance.		
<i>Проблема, над которой работали ученые, имела огромное значение.</i>			

**I. Проанализируйте следующие предложения, укажите признак(и) нахождения сказуемого. Переведите предложения на русский язык.**

1. Great prospects for saving man's labour are opened up by the rapid progress made in telematics, electronics and automation.
2. The length of the line represents the magnitude of the force.
3. Some bodies reverse their motions from time to time and return at regular intervals to their original positions.
4. Work can be expressed in any units of force and distance.
5. Man has used metals for centuries in gradually increasing quantities.
6. The effects of sun radiation and weather often cause chemical changes in some construction materials.

**II. Проанализируйте следующие сложные предложения, определите вид придаточного предложения и переведите предложения на русский язык.**

1. A current of liquid or gas that absorbs heat at one place and then moves to another place where it mixes with a cooler portion of the fluid and loses heat is called a convection current.
2. When we speak of measuring temperature the liquid thermometer is probably the first thing that comes to mind.
3. Mendeleev proved that when all the chemical elements were arranged in the order of increasing atomic weights, there were periodic recurrences of elements which resembled each other.
4. What we are most interested in here is just one discovery of Faraday, namely, the generation of electricity from magnetism.
5. The question is whether he knows how this lathe works.
6. That radiation can take place in a vacuum is an important characteristic of it.

***Инфинитив***

*Инфинитив* - это неличная форма глагола, которая называет действие, но не указывает на лицо, число и наклонение. Формальный признак инфинитива - частица "to", которая в некоторых случаях опускается. В английском языке имеются следующие формы инфинитива:

	Active Voice	Passive Voice
Simple	<b>to use</b>	<b>to be used</b>
Continuous	<b>to be using</b>	–
Perfect	<b>to have used</b>	<b>to have been used</b>
Perfect Continuous	<b>to have been using</b>	–

Перевод инфинитива на русский язык зависит от его функции в предложении. Инфинитив в английском предложении может выполнять следующие функции:

1. Подлежащего. Стоит перед сказуемым, переводится на русский язык неопределенной формой глагола или существительным.

To complete this laboratory experiment will not take much time.

*Завершить этот лабораторный эксперимент не займет много времени.*

To build good roads is one of the most important tasks.

*Строительство хороших дорог - одна из наиболее важных задач.*

2. Части сказуемого:

а) именной части составного именного сказуемого после глагола-связки **to be**. Переводится неопределенной формой глагола или существительным.

The task is to keep low pressure.

*Задача заключается в том, чтобы поддерживать низкое давление.*

Another possibility was to use quartz.

*Другая возможность заключалась в применении кварца.*

б) составного глагольного сказуемого после модальных глаголов и их эквивалентов, а также глаголов, обозначающих начало, продолжение или конец действия.

The vibration must be eliminated.

*Вибрацию нужно (следует) устранить.*

It is to be remembered that atoms interact with each other.

*Нужно помнить, что атомы взаимодействуют друг с другом.*

The temperature begins to rise sharply.

*Температура начинает резко повышаться.*

3. Дополнения (простого). Переводится неопределенной формой глагола.

The geologist helped to calculate the stability of the building...

*Геолог помог рассчитать устойчивость здания...*

4. а) Обстоятельства цели. Отвечает на вопрос "для чего?", "с какой целью?" Может вводиться союзами "in order (to)" и "so as (to)" - чтобы; для того чтобы. Переводится на русский язык инфинитивом с союзами ДЛЯ ТОГО ЧТОБЫ, ЧТОБЫ или отглагольным существительным с предлогом ДЛЯ.

(In order) to understand the phenomenon the laws of motion should be considered.

*Чтобы понять это явление (для понимания этого явления), необходимо рассмотреть законы движения.*

- б) Обстоятельства следствия. В этой функции инфинитив соотносится с наречиями **too** - слишком; **enough, sufficiently** -достаточно. Инфинитив имеет модальный оттенок возможности и переводится на русский язык неопределенной формой глагола с союзом ЧТОБЫ, ДЛЯ ТОГО ЧТОБЫ и с добавлением глагола "мочь".

Some molecules are large **enough to be seen** in the electron microscope.

*Некоторые молекулы достаточно большие, что их можно увидеть через электронный микроскоп.*

The foundation is **too unstable to install** existing machines.

*Основание слишком неустойчиво, чтобы можно было устанавливать существующее оборудование.*

5. Определения, которое стоит после определяемого существительного.

Может переводиться на русский язык:

а) существительным (когда инфинитив в активном залоге)

Gases have the ability **to become** ionized.

*Газы обладают способностью к ионизации.*

б) неопределенной формой глагола (когда инфинитив в активном залоге)

Energy is defined as the capacity **to do** work.

*Энергия определяется как способность совершать работу.*

в) придаточным определительным предложением (когда инфинитив в страдательном залоге), сказуемое которого имеет оттенок долженствования, возможности или будущего времени.

The apparatus **to be assembled** is very complicated.

Прибор, который  $\left\{ \begin{array}{l} \text{нужно (можно) собрать} \\ \text{будут собирать} \end{array} \right\}$ , очень сложный

### Примечание:

1. Как определение к порядковым числительным и к прилагательному "last" инфинитив переводится личной формой глагола в том времени, в котором стоит сказуемое английского предложения.

Newton was **the first to discover** the basic laws of motion.

*Ньютон первым открыл основные законы движения.*

2. Если инфинитив в функции определения выражен глаголом, соответствующий эквивалент которого в русском языке требует

после себя предлога, то этот предлог при переводе на русский язык ставится перед союзным словом "который".

Here are some more figures **to be referred to** later.

Вот еще несколько цифр, **на** которые будут ссылаться позже.

### Сложные обороты с инфинитивом

#### Сложное подлежащее (или Именительный падеж с инфинитивом)

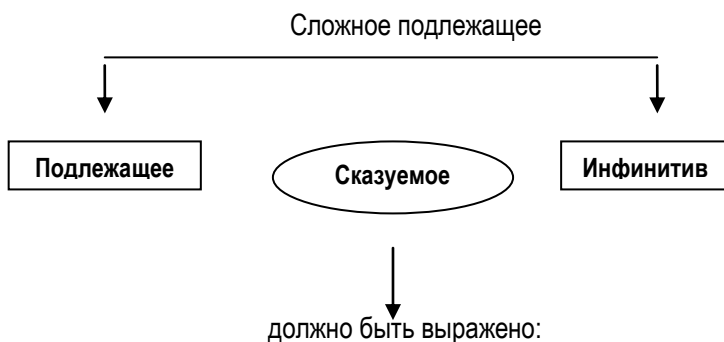

1. Личной формой глаголов, обозначающих умственную деятельность или чувственное восприятие, в страдательном залоге. Наиболее распространенными из них являются: **to assume, to believe, to consider, to claim, to conclude, to declare, to expect, to find, to feel, to formulate, to guess, to hear, to indicate, to know, to mention, to notice, to observe, to predict, to prove (доказывать), to say, to see, to state, to suggest, to suppose, to think** и др.

2. Глаголами: **to appear, to seem, to happen, to prove (оказываться), to turn out** в действительном залоге.

3. Глаголом-связкой **to be**, за которым следуют прилагательные: **likely, unlikely, certain, sure**.

**Возможны два способа перевода оборота "сложное подлежащее":**

1. Перевод начинается со сказуемого, которое переводится неопределенно-личным предложением (соответствует 3-му лицу множественного числа, например, сообщают, предположили, известно и т.п.). Сам оборот переводится придаточным дополнительным предложением с союзом ЧТО (реже ЧТОБЫ, КАК), в котором инфинитив становится сказуемым.
2. Порядок слов английского предложения сохраняется, инфинитив переводится сказуемым, а сказуемое английского предложения переводится вводным предложением с союзом КАК.

The **prices** are expected **to fall**.

1. *Ожидают, что цены упадут (будут падать).*
2. *Цены, как ожидают, упадут (будут падать).*

**This reaction** turned out **to lead** to good results.

1. *Оказалось, что эта реакция дает хорошие результаты.*
2. *Эта реакция, как оказалось, дает хорошие результаты.*

Примечания:

1. Глагол **to find** в обороте "сложное подлежащее" часто переводится "оказываться".

Coal was found to be rather abrasive.

*Оказалось, что уголь имеет значительные абразивные свойства.*

2. Если в обороте "сложное подлежащее" глагол **to prove** стоит в активном залоге, он имеет значение "оказываться", если в страдательном залоге, то он означает "доказывать".

Gold proved to be unattacked by moisture.

*Оказалось, что на золото не действует влага.*



Gold was proven to be unattacked by moisture.

*Доказали, что на золото не действует влага.*

3. Если в обороте "сложное подлежащее" инфинитив выражен глаголом-связкой **to be**, то глагол **to be** можно не переводить.

The interpretation was found to be convincing.

*Объяснение оказалось убедительным.*

4. Если в предложении с оборотом "сложное подлежащее" за сказуемым следует дополнение с предлогом **by**, а затем инфинитив, то при переводе на русский язык это дополнение становится подлежащим главного предложения, а глагол в страдательном залоге заменяется глаголом в активном залоге и становится сказуемым главного предложения.

The goods are reported by the sellers to have been shipped on Friday.

*Поставщики сообщают, что товары были отгружены в пятницу.*

### Сложное дополнение (или Объектный падеж с инфинитивом)

#### Сложное дополнение

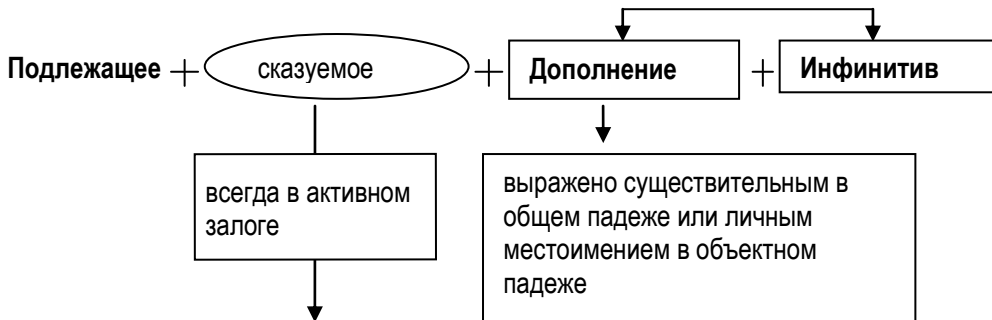

должно выражать:

1. Мнение, суждение, предположение: **to assume, to believe, to consider, to declare, to expect, to find, to know, to prove, to suppose, to show, to think** и др.

2. Чувственное восприятие (после них инфинитив стоит без частицы "to"): **to see, to hear, to feel; to notice, to observe, to watch.**
3. Желание, просьбу, требование, приказание: **to want, to wish, to desire, to like (would/should like), to require, to order** и др.
4. Разрешение, принуждение: **to allow, to permit, to enable, to cause, to force, to make.**

Оборот "сложное дополнение" после глаголов первых трех групп переводится придаточным дополнительным предложением с союзами ЧТО, ЧТОБЫ, КАК. При этом дополнение становится подлежащим, а инфинитив – сказуемым придаточного предложения.

The ancients thought **a molecule to be** the smallest particle of a substance.

*Античные ученые думали, что молекула – это наименьшая частица вещества.*

During the experiment they saw **the temperature fall** rapidly.

*Во время опыта они видели, что (как) температура быстро падала.*

We want **them to take** part in this conference.

*Мы хотели, чтобы они приняли участие в этой конференции.*

При переводе на русский язык оборота "сложное дополнение" после глаголов **to make, to cause, to force**, как правило, сохраняется порядок слов английского предложения.

An increase in temperature makes particles of any substance move more rapidly.

*Повышение температуры заставляет частицы любого вещества двигаться быстрее.*

При переводе оборота "сложное дополнение" после глаголов **to allow, to enable, to permit** можно:

- 1) сохранить порядок слов английского предложения, если инфинитив имеет форму активного залога;
- 2) переводить инфинитив сразу после сказуемого, если он имеет форму страдательного залога:

- 1) This **enables** the scientists **to state** the laws of planetary motion.

*Это позволило ученым сформулировать законы движения планет.*

- 2) This **enabled** the laws of planetary motion to be stated.

*Это позволило сформулировать законы движения планет.*

### **Инфинитивный оборот с предлогом "for"**

Оборот **"for + существительное (или местоимение) + инфинитив"** представляет собой единую синтаксическую группу, в которой действие, выраженное инфинитивом, производит лицо или предмет, обозначенное данным существительным или местоимением.

Оборот **"for + существительное + инфинитив"** выполняет функции различных членов предложения (в научно-технической литературе чаще всего функции обстоятельства цели или следствия).

На русский язык этот оборот переводится неопределенной формой глагола или придаточным предложением, подлежащим которого становится существительное или местоимение этого оборота, а сказуемым – инфинитив, при этом предлог **"for"** опускается.

It is necessary **for the reaction to be accelerated.**

*Необходимо ускорить реакцию.*

There must be two objects involved **for a force to exist**.

*Необходимо наличие двух предметов для того, чтобы существовала сила.*

***I. Определите функцию инфинитива в следующих предложениях.  
Переведите предложения на русский язык.***

- A.
1. To conduct an electric current is to transmit electrons.
  2. To conduct an electric current a source of power is needed.
  3. To prove that lightning is atmospheric electricity Franklin carried on his famous kite experiment.
  4. To prove that lightning is atmospheric electricity required systematic observations and experiments.
  5. To explain why the formulas given here are correct would require much time.
  6. To explain why the temperatures of the observed bodies are quite different one should refer to the law of thermodynamics.
- B.
1. In order to make rubber more elastic it is necessary to mix it with sulphur.
  2. In order to characterize the position of an arbitrary point P coordinates are used.
  3. In order to do mechanical work two conditions are necessary, namely, there must be a force and it must act through a distance.
  4. In order to measure temperature it is necessary to choose some kind of temperature scale.
  5. In order to prove any statement it is necessary to make experiments and observations.
  6. Titanium is too active to be found free in nature.
  7. Any absorption in this region is too weak to be observed.
  8. The waves are too short to affect the eye.
  9. This method is not accurate enough to give reliable results.

- C. 1. The question to be answered requires some time.
2. A voltmeter is an instrument to be used for measuring the potential difference between any two points in a circuit.
3. The useful work to be done by a machine is less than the total work to be performed by it.
4. Cast iron is a general term to be applied to iron-carbon alloys containing more than 2.14% of carbon.
5. When the currents to be detected and measured are very small one should use a galvanometer.
6. When a gas is heated at constant volume, no work is done by the gas. The specific heat to be obtained by this method of heating is known as the specific heat at constant volume.
7. Robert Hook was the first to demonstrate the simplicity of the basic law of elasticity.
8. The first person who was the first to make motor transport really popular was Henry Ford, an American manufacturer...
9. Russian scientist Petroff was the first to prove that metals can be charged by friction.
10. Daniel Bernouilli was the first to discover and formulate in 1738 the law explaining gas pressure on the wall of a container as a result of the collision of separate molecules.

***II. Переведите следующие предложения на русский язык, обращая внимание на инфинитив.***

1. To develop high-efficiency systems with low maintenance requirements considerable effort has been made.
2. The inside of the tube is to be carefully cleaned to remove dust and other foreign matter.

3. To determine the relation between pressure and volume at constant temperatures it is necessary to maintain a given, constant mass of gas at constant temperature and observe how the changing of pressure affects the volume to be occupied by this mass of gas.
4. Copper to be used for tubing has high corrosion resistant qualities.
5. The rate of gas flow does not have to be large.
6. It is important to know the basic principles to be observed in the design and use of optical equipment.
7. It is to be remembered that the object of Joule's experiment was to obtain the relation between heat and work.
8. In fact, to measure the current strength and the voltage is not difficult at all, for all you have to do is to connect an ammeter or a voltmeter in the circuit and then you can directly read off the amperes of the former or the volts of the latter.
9. To test the accuracy of the method will take some time.
10. For small currents to be detected and measured one should use a galvanometer.

***III. Переведите следующие предложения, обращая внимание на оборот "сложное подлежащее с инфинитивом".***

1. Heat is known to be a form of energy but some centuries ago it was supposed to be a kind of a substance which was believed to flow from a hotter body to a colder one.
2. Some liquids prove to be good conductors of electricity.
3. Some very sensitive galvanometers are reported to detect a current as small as  $10^{-11}$  of an ampere or even smaller.
4. Electrons and holes are considered to be the negative and positive carriers of electric charges, respectively, and they are certainly responsible for the conductivity of a semiconductor.

5. Particles of matter under certain conditions behave much like the planets in the air; the chief difference between a particle and a planet appears to be that of size.
6. Germanium atoms have been found to consist of a nucleus and 32 electrons.
7. The mass of the body may be considered to be concentrated in the centre of gravity of the mass.
8. India appears to have been acquainted with iron and steel from an early age.
9. Amorphous substances such as glass and resin proved to have no definite melting point.
10. In consequence, the hole appears to move through the crystal in the opposite direction, that is to say, from the positive end to the negative one.
11. As for conductivity in open air, air is found to be a conductor only when ionized.

***IV. Переведите следующие предложения. Сравните структуры инфинитивных оборотов.***

1. The word "geometry" is known to derive from two Greek words: "geo" (earth) and "metron" (measure). We know the word "geometry" to derive from two Greek words: "geo" (earth) and "metron" (measure).
2. Astronomy, philosophy and mathematics are supposed to have been known in Egypt as early as 5000 years B.C. The scientist suppose astronomy, philosophy and mathematics to have been known in Egypt as early as 5000 years B. B.
3. A molecule was believed to be the smallest particle of a substance. The ancient scientists believed a molecule to be the smallest particle of a substance.
4. They showed the dependence of the pressure on the temperature to be linear. The dependence of the pressure on the temperature was shown to be linear.
5. These values are considered to be in good agreement with the experimental ones. They consider these values to be in good agreement with the experimental ones.

***V. Переведите следующие предложения на русский язык, обращая внимание на оборот "сложное дополнение с инфинитивом".***

1. We know the strength of the current to depend on the resistance of the circuit.
2. The ancient philosophers believed motion to be a forced, temporary state of a body due to the action of external forces.
3. Experiments show the force of gravity acting upon a given body to be different at various points on the Earth.
4. Everyday observations show hot objects to radiate much more heat than cold ones.
5. We know gamma rays not to carry a charge of electricity and not to be deflected by either an electric or a magnetic field.
6. The addition of heat causes the molecules of a substance to speed up and makes it expand.
7. Attractive forces make molecules collide.
8. The addition of some new elements allows new substances with new properties to be obtained.
9. The third law of thermodynamics permits the behaviour of a substance at a very low temperature to be explained.
10. The plasticity of steel allows it to be worked either hot or cold.
11. Heat absorbed by a liquid causes the liquid to evaporate.
12. Hydrolysis at high temperatures permitted the reaction to be carried out in 30 minutes.

***VI. Проанализируйте предложения, используя графики структуры предложений с инфинитивными оборотами. Переведите предложения.***

- A 1. In ancient times air was considered to be an element.
2. The force of gravity is known to play an important role in many common phenomena of mechanics.



3. This law is stated to have been discovered by M. Lomonosov.
  4. This experiment is expected to give good results in the nearest future.
  5. This device seems to have been used for a long time.
  6. As to this method it has proved to be very useful.
  7. The scientists are unlikely to get the answer to these questions.
  8. This method is certain to be used in applied mechanics.
- B
1. We know dynamics to treat the particles and bodies in motion.
  2. The professor wanted us to test this material as soon as possible.
  3. The scientist felt these results confirm his idea.
  4. Heating causes gas pressure to grow.
  5. Steam made the piston move.
  6. These basic laws of motion enabled many complicated problems of mechanics to be solved.
  7. These instruments allow the pressure to be controlled continuously.
  8. Computers permit a lot of facts and figures to be processed at great speed and with high reliability.
  9. The new working conditions permitted these complicated problems to be solved.
- C
1. This force seems to be acting on the plane.
  2. Bodies are considered to be free when they are not in contact with any other body.
  3. They watched the temperature rise gradually.
  4. Two parallel forces are known to constitute a couple if they are equal in amount and opposite in direction.
  5. Individual atoms or large groups of atoms and molecules were found to have an attraction
  6. The addition of some new elements allows new substances with new properties to be obtained.

7. Different external forces cause the object to change the direction of its motion.

***VII. Переведите следующие предложения, определяя функции инфинитива и инфинитивные обороты.***

1. The stability of an object is measured by the amount of work to be required to make it take a new position.

2. A body is said to have potential energy if it is able to do work.

3. The laws of motion to be discussed in the text are known to have been formulated by I. Newton.

4. Each wheel is assumed to rotate independently.

5. In order for a monitoring system to be effective, however, one must be knowledgeable of the construction of the monitored equipment.

6. Modern computers permit millions of logical operations to be performed and it does not get tired.

7. The problem proved to be less critical than was assumed at first.

8. A problem to be solved by a digital computer must be expressed in mathematical terms.

9. If corrosion arises, an accurate diagnosis must be made in order to carry out the correct treatment.

10. Nickel is used for covering iron and brasses to make them look better.

11. The addition of tin allows rust-resistant properties to be improved.

12. The wave nature of X-rays was finally established: X-rays were found to be waves of exactly the same nature as light but of smaller wave length.

13. Epinus was the first to discover charging by induction. He was also the first to apply mathematics to the study of electricity and magnetism.

14. To charge an object by induction means to charge it by the influence of an electrified body at a distance. Hence, to charge an object by induction, one should hold a charged body at some distance near the object to be charged.

15. This binding force and the force of electrostatic repulsion of the positively charged cores appear to be in equilibrium.
16. Molecules are too small to be seen even with the most powerful microscope.
17. A transistor has no filament to be heated.

***VIII. Переведите следующие предложения на английский язык, используя инфинитив и инфинитивные обороты.***

1. Чтобы определить это отношение, нужно было решить уравнение.
2. Кажется, они сейчас работают в лаборатории.
3. Провести этот эксперимент – значит получить новые данные.
4. Проблема, которую нужно обсудить, связана с законами термодинамики.
5. Профессор хотел, чтобы мы закончили курсовую работу к концу следующей недели.
6. Считают, что новый материал будет обладать очень интересными свойствами.
7. Этот прибор позволяет очень быстро проверить свойства нового материала.
8. Присутствие кислорода заставило смесь быстро сгореть.
9. Определить состав этого вещества очень важно для нас.
10. Дать ясную физическую картину свойств этого вещества – довольно сложно.
11. Он первым открыл это явление.
12. Проблемы, которые предстоит решить в ближайшем будущем, имеют большое значение для развития прикладной математики.
13. Мы хотели, чтобы исследователи тщательно изучили эту проблему.
14. Мы полагаем, что ученые завершат эксперименты через месяц.

15. Следует помнить, что электроны – отрицательные заряды электричества.
16. Было найдено, что молекула воды состоит из двух атомов водорода и одного атома кислорода.

### Причастие

Причастие – это неличная форма глагола, которая обладает признаками как прилагательного, так и глагола. К глагольным свойствам причастия относится его способность иметь прямое дополнение, определяться наречием и иметь формы времени (которое носит относительный характер) и залога.

### Формы причастия

	Participle I		Participle II (or Past Participle)
	Simple	Perfect	
Active Voice	asking	having asked	--
Passive Voice	being asked	having been asked	asked

Причастие в английском предложении может выполнять функции:

- 1) левого или правого определения (Participle I, Simple и Participle II);
- 2) обстоятельства (все формы причастия).

Причастие, за которым следуют поясняющие слова (дополнение или обстоятельство), образует причастный оборот. Функции определения и обстоятельства может выполнять как одиночное причастие, так и причастный оборот.

## Функция определения

1. Participle I, Simple; Active Voice без поясняющих слов, как правило, стоит перед определяемым существительным и переводится на русский язык причастием действительного залога настоящего времени.

The distance from the initial point to the **travelling** body is called the co-ordinate of the body.

*Расстояние от начальной точки до движущегося тела называется координатой этого тела.*

2. Participle I, Simple, Passive Voice в функции определения употребляется реже, чем Participle I, Active Voice и, как правило, стоит после определяемого существительного. Переводится на русский язык причастиями, оканчивающимися на *-мый* или *-щийся (-вшийся)*, или придаточным определительным предложением.

**The investigations** *being carried out* were of great importance.

*Проводимые*  
*Проводившиеся* } *исследования имели большое значение.*

3. Participle II, Passive Voice в функции определения без поясняющих слов может стоять как после определяемого существительного, так и перед ним. Переводится на русский язык страдательным причастием с окончанием *-мый, -ный, -тый*.

The problem **considered**  
The **considered** problem } was of great interest.

*Рассматриваемая*  
*Рассмотренная* } *проблема представляла большой интерес.*

### Примечания:

1. Причастный оборот, т.е. причастие с поясняющими словами, в функции определения стоит, как правило, после определяемого существительного и переводится на русский язык соответствующим причастным оборотом или придаточным определительным предложением.

Electrons **forming an atom** are in motion.

*Электроны, образующие атом, находятся в движении.*

The problems **discussed at the conference** were interesting.

*Проблемы, обсужденные (которые обсуждались) на конференции, были интересными.*

2. Одиночные причастия в функции определения, стоящие в английском языке после определяемого существительного, при переводе ставятся перед определяемым словом.

The substance **obtained** was pure.

*Полученное вещество было чистым (не содержало примесей).*

3. В функции правого определения Participle II, образованное от глаголов, имеющих после себя предлог, переводится на русский язык определительным придаточным предложением, начинающимся с соответствующего предлога, который ставится перед относительным местоимением "который".

The data **referred to** in this paper are reliable.

*Данные, на которые ссылаются, заслуживают доверия.*

4. Если после глагольной формы с окончанием *-ed* стоит предлог с последующим существительным, то это, как правило, Participle II.

The work **performed by** this scientist showed good results.

*Работа, выполненная этим ученым, дала хорошие результаты.*

5. Если в предложении рядом стоят две глагольные формы с окончанием *-ed*, то первая форма, как правило, является причастием в функции определения, а вторая – сказуемым в Past Simple.

The substance obtained **contained** some admixtures.

*Полученное вещество содержало примеси.*

### Функция обстоятельства

1. Participle I, Simple, Active Voice в функции обстоятельства переводится деепричастием несовершенного вида (*что делая?*) или придаточным обстоятельственным предложением. В этой функции данная форма причастия часто имеет перед собой союзы *when, while*. В этом случае возможен перевод с предлогом *при* + существительное.

When working with the microorganisms we found that they produced a variety of antibiotics.

*Работая с  
микроорганизмами,  
При работе с  
микроорганизмами  
Когда мы работали с  
микроорганизмами,*

*мы убедились, что они  
вырабатывают различные  
антибиотики.*

2. Participle I Perfect, Active Voice в функции обстоятельства переводится на русский язык деепричастием совершенного вида (*что сделал?*) или придаточным обстоятельственным предложением, сказуемое которого должно предшествовать действию, выраженному сказуемым английского предложения.

Having passed a short distance the car stopped.

*Пройдя короткое расстояние, автомобиль остановился.*

*После того как автомобиль прошел короткое расстояние, он остановился.*

3. Participle I Simple, Passive Voice в функции обстоятельства переводится на русский язык, как правило, придаточным обстоятельственным предложением, в котором английское причастие становится сказуемым.

Being invited too late he could not take part in the conference.

*Так как его пригласили слишком поздно, он не смог принять участие в конференции.*

4. Participle I Perfect, Passive Voice в функции обстоятельства переводится на русский язык придаточным обстоятельственным предложением с союзом "**после того как**".

Having been tested the new equipment was installed in the shops.

*После того как новое оборудование было испытано, его установили в цехах.*

4. Participle II, Passive Voice в функции обстоятельства, как правило, вводится союзами *when, while* – *когда*, *if* – *если*, *unless* – *если...не*, *until* – *пока...не*, *though* – *хотя* и др. Причастные обороты с предшествующими союзами переводятся на русский язык придаточным обстоятельственным предложением с соответствующим союзом или отглагольным существительным с предлогами "при" (для союзов *when, while*), "без" (для союза *unless*).

When heated, magnetized steel loses its magnetism.

*Когда магнитную сталь нагревают, она теряет свои магнитные свойства.*

*При нагревании магнитная сталь теряет свои магнитные свойства.*



Unless heated this substance does not melt.

*Если это вещество не нагревают, оно не плавится.*

*Без нагревания это вещество не плавится.*

Participle II с предшествующим союзом *as* в функции обстоятельства переводится обычно краткой формой страдательного причастия с союзами "как", "так, как".

He solved the problem as stated above.

*Он решил эту задачу, как указано выше.*

Participle II от глаголов *to give, to see, to state* в функции обстоятельства, стоящего в начале предложения, переводится следующим образом:

*given* – если дано; если имеется; при условии

*seen* – если рассматривать

*stated* – если сформулировать

Given the weight and the specific gravity of a body you can calculate its volume.

*Если дан (имеется) вес и удельный вес тела, вы можете вычислить его объем.*

### **Независимый причастный оборот**

Это оборот, в котором перед причастием стоит существительное в общем падеже или личное местоимение в именительном падеже, т.е. стоит свое собственное подлежащее, отличное от подлежащего всего предложения. К этому подлежащему и относится действие, выраженное причастием. Независимый причастный оборот логически связан с предложением и выполняет в нем функцию обстоятельства. Независимый причастный оборот всегда отделяется запятой и может стоять в начале или в конце предложения.

Если независимый причастный оборот стоит в начале предложения, то он переводится на русский язык придаточным обстоятельственным предложением с союзами: *когда; если; так как; после того, как; хотя* и др.

Если независимый причастный оборот стоит в конце предложения, то он переводится самостоятельным предложением с союзами: *а, и, но, причем* или без них.

В обоих случаях причастие переводится личной формой глагола в функции сказуемого.

**The road conditions being unchanged**, the automobile can travel at a constant speed.

*Когда (если) дорожные условия не изменяются, автомобиль может двигаться с постоянной скоростью.*

The term "speed" means the rate of motion, **the term "velocity" meaning the speed in a definite direction.**

*Термин "speed" означает темп движения, а термин "velocity" означает скорость в определенном направлении.*

### Примечания:

1. Независимый причастный оборот может вводиться предлогом *with*, который на русский язык не переводится.

With the experiments having been carried out, they started new investigations.

*После того как опыты были закончены, они начали новые исследования.*

2. В независимом причастном обороте *-ing* форма глагола *to be (being)* может опускаться при переводе.

The work (being) finished, he went home.

*Когда работа была закончена, он пошел домой.*

## Сложное дополнение (или Объектный падеж) с причастием

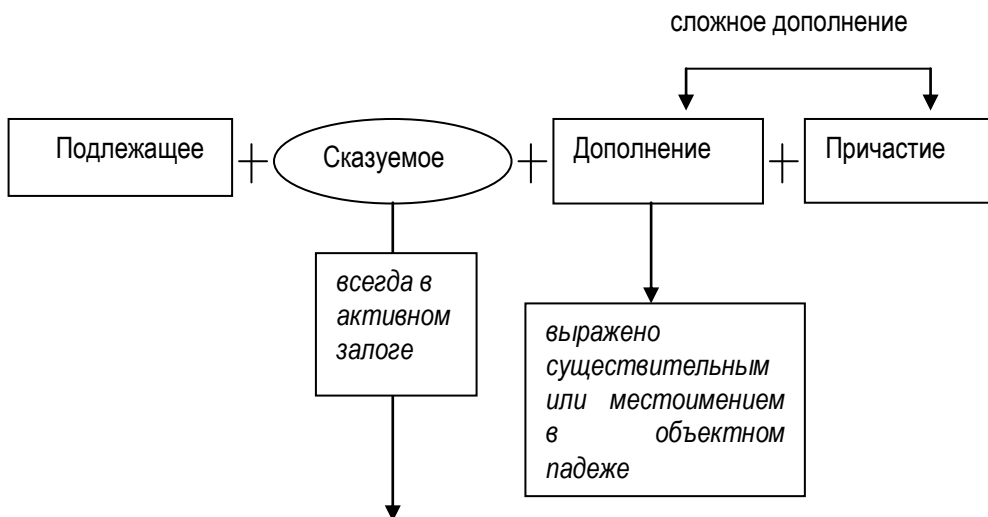

выражено, как правило, глаголами чувственного восприятия: *to feel, to hear, to see, to notice, to observe, to watch* и др.

They watched **the temperature gradually rising**.

*Они следили (за тем), как температура постепенно повышалась.*

Оборот "сложное дополнение с причастием" переводится на русский язык придаточным дополнительным предложением с союзом "что" или "как", причем причастие становится сказуемым (т.е. передается личной формой глагола), а дополнение – подлежащим этого придаточного предложения.

Хотя оборот "сложное дополнение с причастием" переводится, как и оборот "сложное дополнение с инфинитивом", между этими оборотами имеется смысловая разница. Причастие выражает длительный характер действия, т.е. действие в процессе его совершения, а инфинитив выражает

в большинстве случаев законченное действие. Поэтому оборот с причастием переводится на русский язык придаточным предложением с глаголом несовершенного вида, а оборот с инфинитивом – придаточным предложением с глаголом совершенного вида (иногда может переводиться и глаголом несовершенного вида).

They saw the temperature gradually rising.

*Они видели, что (как) температура постепенно повышалась*

They saw the temperature gradually rise.

*Они видели, что температура постепенно повысилась*

### Сложное подлежащее (или именительный падеж) с причастием

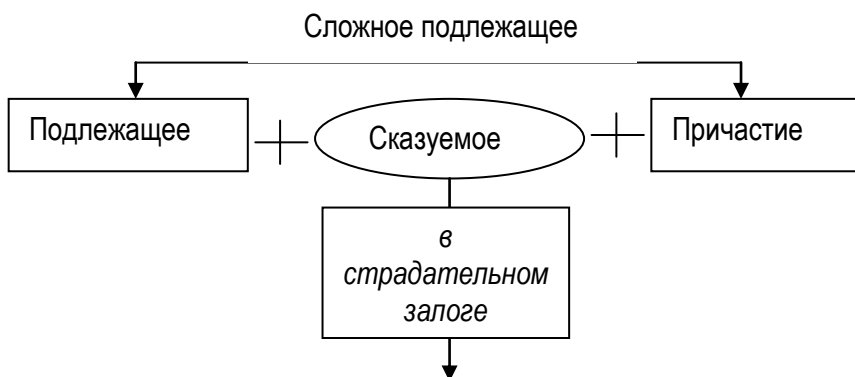

выражено, как правило, глаголами, обозначающими умственную деятельность или чувственное восприятие: *to assume, to consider, to expect, to feel, to see, to observe, to notice* и др.

Перевод следует начинать со сказуемого, которое переводится неопределенно-личным предложением (соответствует 3-ему лицу

множественного числа, например, *считают, наблюдали* и т.п.). Сам оборот переводится придаточным дополнительным предложением с союзом "как" или "что", в котором причастие становится сказуемым.

He was seen repairing the engine.

*Видели, как (что) он ремонтировал двигатель.*

**VI. Определите функцию Participle I в следующих предложениях. Переведите предложения на русский язык.**

- A. 1. Motor cars and airplanes burn liquid fuel producing heat which is converted into the kinetic energy of motion.
  2. At an average room temperature a gas molecule travels at the tremendous rate of several hundred meters per second making more than five milliard collisions with other speeding molecules every second.
  3. Being acted upon by an external force a body will change its state of rest to a state of motion.
  4. While freezing water expands by about 9% of its volume.
  5. Falling on a special kind of cell, a light beam can generate an electric current. The appliance using that phenomenon to produce electricity is called a photoelectric cell.
  6. Being influenced by temperature and pressure, the volume of any substance is not constant.
  7. Being separated from the sun by vacuum the earth receives its heat by radiation.
  8. This experiment shows that the air being heated in the flask expands and shifts the drop of water.
  9. Being subjected to high temperatures aluminium loses its strength rapidly.
  10. The liquid passing through this pipe is gradually warmed.
- B. 1. Having alloyed copper with tin Greeks and Romans formed a new alloy called "bronze".

2. Having been heated at one end and then left to itself, a solid body eventually acquires a uniform temperature.
3. Having determined the number of amperes and volts one can find the resistance of the coil.
4. Having lost some of its electrons, the atom has a positive charge.
5. Having been adjusted by the operator the machine tool continued to work.
6. Having started the search for new kind of fuel the scientist must keep in mind the disadvantages of the new resources.
7. Having been heated the substance occupied every portion of the container.

***VII. Переведите на русский язык предложения с Participle II, предварительно определив его функцию.***

- A.
1. Heat absorbed by a solid may cause the solid to melt or to change from a solid to a liquid state.
  2. Liquid fuels if used in the cylinders of diesel engines produce heat.
  3. If produced by friction heat is usually considered as useless work.
  4. The temperature of the liquid obtained remained constant.
  5. When alloyed with some other metals aluminium gets much better characteristics.
  6. The machines used differed in sizes and designs.
  7. The lathe described machined workpieces automatically.
  8. If heated magnetized steel will lose its magnetism.
  9. The energy transferred by radiation is transmitted from one place to another by waves of exactly the same nature as radio waves.
- B.
1. Numerous experiments followed by sound conclusions helped to solve the problem.
  2. The formation of vapour followed by its diffusion in the atmosphere will be dealt with in the next article.

3. The data referred to in the paper is of great importance.
4.  $10^8$  is a number expressed by one followed by eight zeroes.
5. The Universal gravitation spoken about at the lecture was discovered by Newton in 1665.
6. The agreement arrived at yesterday is of great importance.
7. Bodies acted upon by some force have changed their state of rest.
8. The substance affected by a magnetic field was a metal.
9. The state of the substance influenced by temperature and pressure is taken into account.

***III. Сравните следующие пары предложений. Обратите внимание на независимый причастный оборот.***

1. Two objects being at the same temperature have the same average energy of motion of their molecules. Two objects being at the same temperature, the average energy of motion of their molecules is the same.
2. An automobile covering 240 km in 4 hours, its average speed is 60 km/hr. An automobile covering 240 km in 4 hours has an average speed of 60 km/hr.
3. Having discovered the element 101, American scientists called it "mendelevium" to honour Mendeleev's name. The element 101 having been discovered, American scientists called it "mendelevium" to honour Mendeleev's name.

***IV. Определите независимый причастный оборот в следующих предложениях и переведите предложения на русский язык.***

1. A gas being heated at constant pressure, work is done by the gas while expanding.
2. The temperature rising, the bodies expand, their volume increasing.
3. Friction produces heat, the heat produced by friction being considered as lost heat or useless work.

4. The name electronics is known to be derived from the word electron, the electron itself being the basic unit of negative electricity and all electric currents consisting of electrons in motion.
5. Other conditions being equal, iron will oxidize more rapidly than mercury or silver.
6. In other words, we convert the chemical energy of the fuel into heat energy, the latter being converted into mechanical and then electrical energy.
7. Iron or steel being magnetized, the molecules are moved into a new arrangement which is caused by the force used for magnetizing them.
8. With a car moving with constant velocity, the distance travelled is directly proportional to the time.
9. With the electric current passing through a wire, the heat developed will depend upon the amount of current.
10. The length of a conductor doubled, the resistance is doubled.
11. Non-ionized clean air is also considered to be a good insulator, it often being used for this purpose in electrical apparatus.

***V. Переведите следующие предложения на русский язык, обращая внимание на форму и функцию причастия.***

1. Being tested for strength, a piece of metal is clamped in a special machine.
2. When testing a piece of metal for strength the engineer clamps it in a special machine.
3. A piece of metal being tested for strength is clamped in a special machine.
4. A piece of metal tested for strength, the engineer clamps it in a special machine.
5. Having tested a piece of metal, the engineer could determine its strength.
6. Having been tested for strength, a piece of metal was removed from the machine.
7. When tested for strength a piece of metal is clamped in a special machine.



8. Many questions were discussed at the conference, great attention being paid to the new types of computers.
9. The technique involved increased the output considerably.
10. The results much spoken about at the conference were obtained in numerous experiments.
11. Personal computers being used for many purposes, scientists go on to improve their quality.
12. The equipment having been received, we could install it in the laboratory.

***VI. Переведите следующие предложения, обращая внимание на обороты "сложное подлежащее с причастием" и "сложное дополнение с причастием".***

1. As a rule, most of the non-metals are found transmitting only a negligible current; that is why they are considered as insulators.
2. Newton noticed the apple falling from a tree.
3. We consider pure germanium being a poor conductor.
4. A chemical change was shown as being accompanied by a change in temperature.
5. Early experimenters noticed many bodies becoming hot in consequence of work but could not explain this phenomenon.
6. The specific heat of a substance has been shown varying considerably with temperature.
7. Most elements have been found consisting of two or more isotopes. Thus, oxygen atoms of atomic number 8 are found having atomic weights of 16, 17, and 18.

***VII. Переведите следующие предложения на русский язык.***

1. The temperatures being kept below 100°C, a heat storage tank can be constructed much cheaper.

2. Knowing that the state of a substance depends on the pressure applied, one can change a substance into the states desired varying the pressure.
3. When properly hardened steel becomes hard and strong.
4. The energy lost by the hot water is equal to the energy transferred to the cold water.
5. All metals are good conductors, silver being the best.
6. The properties described required further investigations.
7. While repairing the machine the operator found two broken parts.
8. Solid bodies offering resistance to a change in form or size exhibit the property of recovery.
9. Having established relations of independence among physical facts, modern physics tries to interpret these relations.
10. When acted upon by an external force a body will change its state of rest to a state of motion.
11. With the distorting force removed, elastic bodies exhibit the property of recovering to their original state.
12. Newton's laws of motion referred to are to be modified when speed approaches the speed of light.
13. Having become saturated the vapour may condense in the air.
14. We watched mercury expanding.
15. The fall of temperature of the hotter body was shown by experiments being equal to the rise of temperature in the other.
16. Having been seen in action the device was greatly modified.
17. Heat was considered as being an invisible weightless substance that could be transferred from one body to another.

***VIII. Переведите на английский язык, используя причастие.***

1. Силы, действующие на тело, производят работу.
2. Тело, обладающее потенциальной энергией, может совершать работу.

3. Давление жидкости отличается от давления, оказываемого (to exert) твердыми телами.
4. Кинетическая энергия, которой обладает (to possess) тело, зависит от его массы.
5. Используемое оборудование было получено в прошлом году.
6. Использованное оборудование заменяется.
7. Испытываемые материалы различаются по своим свойствам.
8. Испытанные материалы требовали дальнейшей обработки.
9. Зная эту величину, вы можете решить это уравнение.
10. Температуру измеряют, используя градус Цельсия как единицу.
11. Измерив совершенную работу, экспериментатор продолжил опыт.
12. Теплоту можно превратить в работу, причем отношение теплоты к работе является постоянным.
13. Так как работа была очень трудная, студенты не смогли ее выполнить.
14. Когда средняя скорость молекул жидкости понижается, температура тоже понижается.
15. Испарение производит охлаждающее действие.
16. Если давление воздуха, действующее на поверхность воды, меньше нормальной величины, кипение начинается при температуре ниже 100 градусов Цельсия.

### Герундий

	Simple	Perfect
Active Voice	asking	having asked
Passive Voice	being asked	having been asked

Герундий – это неличная форма глагола, совпадающая с формами причастия I (Simple и Perfect) и обладающая свойствами как глагола, так и

существительного. Как глагольная форма, герундий может выражать категории залога и времени, может иметь при себе прямое дополнение и определяться наречием. К именным свойствам герундия относятся следующие:

а) перед герундием может стоять предлог;

б) герундию может предшествовать существительное в общем или притяжательном падеже или притяжательное местоимение;

в) герундий может выполнять такие же синтаксические функции, что и существительное, т.е. функцию подлежащего, части сказуемого, дополнения, обстоятельства и определения.

Итак, герундий или герундиальный оборот (т.е. герундий с зависимыми словами) может выполнять в предложении следующие функции:

1. **Подлежащего.** В этой функции герундий переводится на русский язык отглагольным существительным или инфинитивом.

*Lifting this heavy weight is impossible without necessary appliances.*

*Поднятие этого тяжелого груза  
Поднять этот тяжелый груз*



*невозможно без использования  
необходимых приспособлений.*

## 2. Части сказуемого:

а) составного именного после глагола "to be" и сочетания глагола "to be" с предлогами *for* и *against*. В этой функции герундий переводится на русский язык отглагольным существительным или инфинитивом, а после предлогов *for* и *against* – придаточным предложением.

*One of the effects of heat is changing a solid into liquid.*

*Один из результатов воздействия тепла – это превращение  
твердого тела в жидкость.*

*They are against postponing the negotiations.*

*Они против того, чтобы переговоры были отложены.*

They are for discussing this problem as soon as possible.

*Они за то, чтобы эту проблему обсудили как можно быстрее.*

б) составного глагольного после глаголов, указывающих на начало, продолжение или конец процесса, а также после глаголов *to like, to love, to hate, to prefer, to avoid, to enjoy* и после сочетаний *to be worth..., to be busy....*

They have finished discussing the results of the experiment.

*Они окончили обсуждать результаты эксперимента.*

He likes taking part in conferences.

*Ему нравится принимать участие в конференциях*

It is worth entering into a contract with this company.

*Стоит заключить контракт с этой компанией.*

He was busy drawing up a contract.

*Он был занят составлением контракта.*

3. **Дополнения** *прямого и предложного*. В этой функции герундий можно переводить отглагольным существительным, инфинитивом или придаточным дополнительным предложением.

This forging press needs repairing.

*Этот штамповочный пресс нуждается в ремонте.*

He insisted on using these substances in the experiment.

*Он настаивал на использовании этих веществ в эксперименте.*

4. **Обстоятельства**. В этой функции перед герундием всегда стоит предлог: *in* – при, во время, в процессе; *on* – после, по; *by* – при помощи, посредством, путем; *after* – после; *before* – до, перед; *without* – без...

**In solving** the problem he made some mistakes.

*При решении (Решая) задачи он допустил несколько ошибок.*

**On reaching** the boiling point the water temperature is no longer increased.

*После достижения (Достигнув) точки кипения температура воды больше не повышается.*

One can perform work **by lifting** a weight.

*Можно совершить работу, поднимая груз (посредством поднятия груза).*

Gas volume can be changed **without changing** its temperature.

*Объем газа можно изменить, не изменяя (без изменения) его температуру.*

5. **Определения.** Определяет существительное и, как правило, вводится предлогом *of* (реже предлогом *for*). Переводится на русский язык существительным в родительном падеже, инфинитивом или придаточным предложением.

There are different methods of obtaining forgings.

*Существуют различные методы получения штамповок.*

Energy is defined as capacity for doing work.

*Энергия определяется как способность выполнять работу.*

A thermometer is an instrument for measuring temperature.

*Термометр – это прибор для измерения температуры.*

### **Герундиальный комплекс (сложный герундиальный оборот)**

Стоящее перед герундием существительное в общем или притяжательном падеже или притяжательное местоимение указывает на предмет или лицо, производящее действие, которое выражено герундием. Такой сложный оборот можно назвать герундиальным комплексом, который может выполнять в предложении функцию подлежащего, именной части составного именного сказуемого, дополнения, обстоятельства,

определения. Как правило, герундиальный комплекс переводится на русский язык придаточным предложением, причем существительное в общем или притяжательном падеже или притяжательное местоимение соответствует в русском языке подлежащему придаточного предложения, а герундий – сказуемому.

We know of || **work and energy being** closely related.

*Мы знаем, что работа и энергия тесно связаны между собой.*

**I. Newton's having formulated** this law || was of great importance.

*То, что И. Ньютон сформулировал этот закон, имело огромное значение.*

Примечание:

1. После таких глаголов как **to like to dislike** , **to prefer** в качестве дополнения может употребляться как герундий, так и инфинитив:

I like skiing in winter. I like to ski in winter.

2. После таких глаголов как **to avoid, to intend, to need, to mind (возражать), to remember, to enjoy, to require, to finish, to excuse, to deny, to forgive, cannot help, to postpone** в качестве дополнения употребляется только герундий.

Would you mind my smoking?

3. Глаголы **to stop, to forget** в зависимости от того, следует ли за ними герундий или инфинитив имеют разное значение:

He stopped to speak to me.

*Он остановился, чтобы поговорить со мной.*

He stopped speaking.

*Он перестал разговаривать.*

4. Только герундий употребляется после следующих глаголов с предлогами, а также после следующих словосочетаний с предлогами:

to depend on

to insist on

to know of  
to object to  
to prevent from  
to thank for  
to think of  
to go on  
to give up  
to consist in

to be capable of  
to be fond of  
to be interested in  
to be pleased (displeased) at  
to be proud of  
to be busy in  
to be surprised at  
to be worth of

### Сравнение герундия и причастия

	Герундий	Причастие
Подлежащее	<b>Heating</b> copper wire from 0° to 100° increases its resistance by 40%. <i>Нагревание медной проволоки от 0° до 100° увеличивает ее сопротивление на 40%.</i>	--
Обстоятельство	<b>In heating</b> copper wire from 0° to 100° its resistance is increased by 40%. <i>При нагревании медной проволоки от 0° до 100° ее сопротивление увеличивается на 40%.</i>	<b>Heating</b> copper wire from 0° to 100° we increase its resistance by 40%. <i>Нагревая медную проволоку от 0° до 100°, мы увеличиваем ее сопротивление на 40%.</i>
Определение	The <b>boiling</b> point of water is one hundred degrees Centigrade. <i>Точка кипения воды – 100 градусов Цельсия.</i>	<b>Boiling</b> water is changing into steam. <i>Кипящая вода превращается в пар.</i>

#### I. Переведите следующие сочетания. Обратите внимание на разницу в переводе причастия и герундия как определений.

Boiling water – boiling conditions; freezing point – freezing water;  
measuring instrument – measuring position; heating device – heating



effect; operating characteristics – operating turbine; evaporating process – evaporating substance; dancing room – dancing girl; sleeping man – sleeping car.

**II. Прочитайте следующие предложения с ing-формами.**

**Объясните разницу в переводе.**

1. Studying applied mechanics students acquire considerable knowledge of the fundamentals of mechanics. Studying applied mechanics is necessary for future engineers.
2. Adding heat to a substance does not always cause the rise of its temperature. Adding heat to a substance one does not always cause the rise of its temperature.
3. Lifting this heavy weight is impossible without necessary appliances. Lifting this heavy weight one performs work.

**III. Определите функцию герундия и переведите предложения на русский язык.**

1. A generator is a machine for converting mechanical energy into electrical energy by making use of the interaction between a conductor and a magnetic field.
2. It is possible to add a considerable amount of heat without producing any temperature change in the given substance.
3. In connecting the ends of the metals with a metal wire one causes the current to flow through that wire.
4. On connecting the ends of the metals with a metal wire we caused the current to flow through that wire.
5. The electric lamp widely used for the generation of light also depends upon the heating property of electricity.

6. Programming a computer involves analysing the problem to be solved and the plan to solve it.
7. In stretching an elastic object the elastic limit should not be exceeded .
8. Superheating is a process of heating a liquid above its boiling point without converting it into vapor.
9. On studying the nature of that new phenomenon they were not satisfied with the results obtained.
10. Heat is a form of energy Studying heat mainly consists in studying the changes of energy.
11. In studying the theory of semiconductors Joffe had in mind the direct conversion of solar energy into electricity.

***VI. Переведите предложения на русский язык, обращая внимание на герундиальный комплекс.***

1. Plants are useful sources of energy thanks to their storing the sun's radiation in chemical form.
2. We know of the strength of current depending on the resistance of the circuit.
3. After their having been compressed gases will return to the original volume.
4. Plasma differs greatly from ordinary gases because of its being composed of charged particles.
5. They objected to your results being published before all the experiments were completed.
6. Their having obtained good results at such a temperature caused a great surprise.
7. We know of work and energy being closely related.
8. Mankind is interested in atomic energy being used for peaceful purposes.

9. The ammeter being used to measure the current flowing in an electric circuit is well known to each engineer.

***V. Замените инфинитив в скобках формами герундия, поставив перед герундием соответствующий предлог.***

1. I think ... (to take) part in the forthcoming conference.
2. We had much difficulty ... (to translate) the article.
3. I object ... (to discuss) this problem at our meeting.
4. There is no possibility ... (to carry out) this experiment in two days.
5. He is engaged ... (to write) a book.
6. She insisted ... (to help) us with our work.
7. I like the idea ... (to organize) a scientific conference on this important problem.
8. I was afraid ... (to be) late for the lecture.
9. He succeeded ... (to obtain) reliable results.

***VI. Это упражнение на сравнение герундия и причастия. Переведите предложения на русский язык, предварительно определите -ing-форму.***

- A.
1. Changing the resistance of the circuit, one may control current flow.
  2. Changing the resistance of a circuit is one of the methods of controlling the flow of current in the circuit.
  3. The electric current passing through a wire heats that wire.
  4. The electric current passing through a wire, the heat developed will depend upon the amount of current.
  5. Adding heat to a boiling liquid we make it change its state without changing its temperature.
  6. By adding heat to a boiling liquid we make it change its state without changing its temperature.

- B. 1. A liquid being heated to the boiling point, its temperature can be raised no higher.
2. The process of transmitting energy from one body to another without doing work is called heat exchange.
3. Mechanical energy is a specific physical quantity characterizing the capacity of bodies for doing useful work.
4. They knew about our having done this work.
5. The characteristic feature of the analytic geometry is applying algebra in the study of geometry.
6. On being heated, magnetized steel will lose its magnetism because heating makes the molecules move around rapidly and expands the metal.

**VII. *Переведите на английский язык, используя герундий***

- A. 1. Он понимает важность изучения иностранных языков.
2. Когда я пришел, он был занят переводом какой-то статьи.
3. Я поблагодарил его за то, что он помог нам в нашей работе.
4. Я должен закончить эту работу, прежде чем я пойду домой.
5. Его рабочее место всегда в порядке.
6. Мне нравится переводить технические книги с английского языка.
7. Они были горды тем, что добились таких интересных результатов.
- B. 1. Мы уверены в том, что она станет хорошим инженером.
2. Преподаватель сослался на то, что проблема эта обсуждалась раньше.
3. Студенты удивлены тем, что их спросили о переменных и функциях.
4. Я слышал о том, что его назначили директором большого завода.

5. Мы настаивали на том, чтобы они начали переговоры немедленно.
6. То, что он спросил вас об этом, очень важно.
7. Он настаивает на том, что эта величина приближается к нулю.
8. Мы удивлены тем, что вы получили такие хорошие результаты.

### Сослагательное наклонение

Сослагательное наклонение выражает действие, которое рассматривается как предполагаемое, желательное или возможное при определенных условиях. Формы сослагательного наклонения переводятся на русский язык сочетанием глагола в прошедшем времени с частицей "бы" или с союзом "чтобы".

### Формы сослагательного наклонения

		<b>Синтетические</b>	<b>Аналитические</b>
Present Subjunctive	<i>Выражаемые действия</i>	I, he, she We, you, they     be/ ask	—
Past Subjunctive	<i>относятся к настоящему или будущему времени</i>	I, he, she We, you, they     were/asked	<b>should, would, could, might + Simple Infinitive</b>
Perfect Subjunctive	<i>Выражаемые действия относятся к прошлому</i>	I, he, she     had been We, you, they     had asked	<b>should, would, could, might + Perfect Infinitive</b>

## Употребление сослагательного наклонения

Типы предложений	Примеры	Перевод
1. В простых предложениях	They would like to take part in the conference.	Им хотелось бы принять участие в конференции.
<p>2. В сложных предложениях:</p> <p>а) В <u>придаточных предложениях подлежащих после безличных оборотов</u>, типа:  <b>It is necessary that...</b>  <b>It is important that...</b>  <b>It is advisable that...</b>  <b>It is desirable that...</b></p> <p>б) В <u>придаточных дополнительных предложениях после глаголов, выражающих приказание, требование, совет, предложение: to order, to require, to advise, to propose</u> и т.д.</p> <p>в) В <u>придаточных обстоятельственных предложениях цели после союзов: so that – чтобы</u>  <b>lest – чтобы...не...</b>  <b>in order that... - для того чтобы</b></p> <p>г) В <u>придаточных предложениях сравнения после союзов: as if – как если бы</u>  <b>as though – как будто бы</b></p>	<p>It is necessary that the work (should) be finished as soon as possible.</p> <p>They suggested that this problem (should) be discussed immediately.</p> <p>They lowered the pressure lest it be too high.</p> <p>The instrument behaves as if it were out of order.</p>	<p><i>Необходимо, чтобы работа была закончена как можно быстрее.</i></p> <p><i>Они предложили, чтобы этот вопрос немедленно обсудили.</i></p> <p><i>Они понизили давление, чтобы оно не было слишком высоким.</i></p> <p><i>Прибор ведет себя так, как если бы он был не в порядке.</i></p>

## Условные предложения

Типы предложений	Условное придаточное предложение	Главное предложение
<p style="text-align: center;">I тип</p> <p>Изъявительное наклонение</p> <p><i>Условие <u>реальное</u>, относящееся к будущему времени</i></p>	<p><b>Present Simple</b> If a body is heated</p> <p><i>Если тело нагреют,</i></p>	<p><b>Future Simple</b> the motion of its atoms will be more intensive.</p> <p><i>движение его атомов будет более интенсивным.</i></p>
<p style="text-align: center;">II тип</p> <p>Сослагательное наклонение</p> <p><i>Условие <u>нереальное</u> (или маловероятное), относящееся к настоящему или будущему времени</i></p>	<p><b>Past Subjunctive = Past Simple</b></p> <p>If the body were (was) heated</p> <p><i>Если бы это тело нагрели,</i></p>	<p><b>should/would, could/might + Simple Infinitive</b></p> <p>the motion of its atoms would be more intensive.</p> <p><i>то движение его атомов было бы более интенсивным.</i></p>
<p style="text-align: center;">III тип</p> <p>Сослагательное наклонение</p> <p><i>Условие <u>нереальное</u>, относящееся к прошедшему времени</i></p>	<p><b>Past Perfect Subjunctive = Past Perfect</b></p> <p>If this body had been heated</p> <p><i>Если бы это тело было нагрето,</i></p>	<p><b>should/would, could/might + Perfect Infinitive</b></p> <p>the motion of its atoms would have been more intensive.</p> <p><i>движение его атомов было бы более интенсивным.</i></p>

### Примечание:

В условных придаточных предложениях II и III типа союзы *if, provided* могут быть опущены. В этом случае в придаточном предложении наблюдается обратный порядок слов, т.е. сказуемое или вспомогательный глагол ставится перед подлежащим.

Had we enough spare time, we should attend the conference.

*Было бы у нас*

*Если бы у нас было*



*достаточно свободного времени, мы бы посетили эту конференцию.*

### ***I. Переведите следующие предложения, обращая внимание на сослагательное наклонение***

1. Hence, a higher temperature is required to convert water into steam at a high pressure than it would be necessary at a low pressure.
2. It would be quite wrong to think that conducting materials are the only materials to be used for power transmission.
3. One might ask: "Can every substance exist in all of these four states?"
4. Suppose that one could live in a world where the average temperature were 250°C. At our ordinary pressures, water and ether would be in a gaseous state.
5. In this case the substance acts as if it were compressed by a very great pressure.
6. We should like to make some remarks about this work.
7. The new system of units suggested that the joule be used as the unit of work and energy.
8. It is necessary that the preliminary reaction be essentially complete.
9. Without friction our world would be very strange, indeed. Without friction between the tyres and the road, a car could not move.
10. The point of application of the resultant force is called the centre of gravity. It is as if the body's weight were concentrated at this point.



11. Much was expected from this method under which it would be possible to repair or replace district heating pipes.

***II. Сравните типы условных предложений и переведите предложения на русский язык.***

1. If he is busy I shall do the work myself.  
If he were busy, I should do the work myself.  
If he had been busy, I should have done the work myself.
2. If we finish our work in time we shall go home.  
If we finished our work in time we should go home.  
If we had finished our work in time we should have gone home.
3. If you come you will see her.  
If you came you would see her.  
If you had come you would have seen her.
4. If this gas is heated in a closed vessel, its volume will not increase.  
If this gas were heated in a closed vessel, its volume would not increased.  
If this gas had been heated in a closed vessel, its volume would not have increased.
5. If this liquid is heated it expands.  
If this liquid were heated it would expand.  
If this liquid had been heated it would have expanded.

***III. Выберите правильную форму глагола.***

1. If a body (will be moving, is moving) then, if no forces (act, will act) on the body, it will go on at a uniform speed in a straight line forever.
2. If a substance (will be, is) a liquid, then its atoms are in motion.
3. If there (is, were) no resistance to motion, a body set into motion could move forever.
4. If we (cooled, had cooled) a melted substance, it would turn from a liquid to a solid.

5. If the force of friction (was, were, is) absent, motion would continue infinitely.
6. If we (had lowered, have lowered) temperature, the reverse transformation could have taken place.
7. If we (have raised, had raised) the temperature, a crystal of one form would have been converted into a crystal of the second form.

***IV. Определите тип условного предложения и переведите предложения на русский язык.***

1. If superheated steam is heated to high temperatures, decomposition may take place if the steam is in contact with a suitable agent; it is likely to take place between 600 and 1200°C.
2. If the magnetic circuit consisted of non-magnetic material, the field would be proportional to the current.
3. As a rule, if the length of a conductor is doubled, the resistance is doubled and if its cross-sectional area is doubled, its resistance is halved.
4. If a piece of wire were replaced by another one of the same length but of double cross-sectional area, it would offer half its former resistance.
5. If we had used a coil with half the number of turns during our last experiment, we should have got a much lower e.m.f.
6. If we had lowered temperature, the reverse transformation would have taken place.
7. If the specific heat at constant volume, for a given gas, has the same value for that gas at all temperatures and pressures, and if the specific heat at constant pressure, for a given gas, is assumed to remain constant at all temperatures and pressures, then it follows that the ratio of the two specific heats of any given gas is also constant.

8. If we were asked today to prove the existence of a connection between electricity and magnetism, we could not do better than point to the electromagnet.

9. The study of semiconductors wouldn't have clarified the relation between the electric charges and matter, if it hadn't enriched physics with new ideas and laws concerning electrical phenomena.

10. The experiment would have been carried out a week ago, if the device hadn't been broken.

11. If you had changed the conditions of the experiment you would have obtained better results.

12. If he knew something about semiconductors, it wouldn't be so difficult for him to understand the Hall effect.

***V. Переведите следующие условные предложения. Объясните отсутствие союзов в них.***

1. Had the pipe a small cross-section, the water flow per second would be certainly small.

2. Were there a conducting wire between two points of unequal potential, the electrons would flow from one of the points to the other.

3. Were it possible to divide the magnets until we reached the molecules, we should find that each molecule was a minute magnet having a north pole and a south pole.

4. On the other hand, the object would not be in equilibrium were it gaining speed or slowing down (accelerating or decelerating).

5. Had he taken into account the properties of the substance under investigation, he would have been careful while working with it.

6. Could one live in a world where the average temperature were 250°C, water and ether would be in a solid state at our ordinary pressures.

7. Were the vapour pressure of a solid at any temperature greater than one atmosphere, the substance would pass directly from the solid to the vaporous condition.

8. Had we raised the temperature, this substance would have been transformed into a gaseous state.

9. Could mercury not expand when heated, it would not be used for taking temperatures.

**VI. Переведите на английский язык.**

1. Если вы сравните эти две силы, то увидите, что разница не значительна (negligible).

2. Если бы эти две силы не были параллельны, они не составили бы пару.

3. Сила притяжения будет уменьшаться, если расстояние от земли будет увеличиваться.

4. Если бы не было света, воды, кислорода, то на земле не было бы жизни.

5. Если бы у нас было достаточно времени, мы бы повторили этот эксперимент.

6. Если бы у нас было достаточно времени вчера, мы бы повторили этот эксперимент.

7. Мы бы решили это уравнение вчера, если бы у нас были эти данные.

8. Спутники двигались бы по прямой, если бы на них не действовала сила притяжения.

9. Если мы будем работать над этой проблемой, мы сможем найти ответ на многие вопросы.

10. Без воды жизнь на земле была бы невозможна.

11. Температура воды увеличилась бы на 10 градусов.

12. Теплота заставила бы жидкость испаряться.

### Многофункциональный глагол "to do"

Смысловой глагол	Вспомогательный глагол	Усилительный глагол *	Заместитель предшествующего сказуемого
<p>This machine-tool <u>does</u> various operations.</p> <p><i>Этот станок <u>делает</u> (выполняет) различные операции.</i></p>	<p><u>Do</u> you know this law?</p> <p><i>Вы знаете этот закон?</i></p> <p>Some substances <u>do not</u> conduct heat.</p> <p><i>Некоторые вещества не проводят тепло.</i></p>	<p>This equipment <u>does</u> help them a lot in their work.</p> <p><i>Это оборудование <u>действительно</u> очень помогает им в работе.</i></p>	<p>Metals conduct electricity better than most of the non-metals <u>do</u>.</p> <p><i>Металлы проводят электричество лучше, чем большинство неметаллов.</i></p>

\* Усилительный глагол **to do** используется для усиления действия, выраженного глаголом-сказуемым. В этом случае **to do** в соответствующей личной форме ставится перед инфинитивом (без частицы «**to**») смыслового глагола. Переводятся такие предложения на русский язык с помощью слов «действительно», «на самом деле», «все же», «ведь».

This equipment does help them a lot in their work.

*Это оборудование действительно очень помогает им в работе.*

The results of two experiments show that melting did take place.

*Результаты двух экспериментов показывают, что плавление все же произошло.*

**I. Переведите следующие предложения на русский язык, обращая внимание на функции глагола "to do".**

A. 1. Carbon resistance does increase unless its temperature rises.

2. The energy of a body or system is the capacity of that system or body for doing work.
  3. The amount of the accomplished work does not depend on the time spent on lifting the weight.
  4. Copper has a greater conductance than iron does.
  5. In fact, to measure the current strength and the voltage is not difficult at all, because all you have to do is to connect an ammeter or a voltmeter in the circuit and then you can directly read off the amperes of the former or the volts of the latter.
  6. The addition of heat does not increase the weight of metal, however, the combination with air does increase its weight.
  7. As the temperature of water rises, so does the pressure of water vapour required to stop further evaporation.
  8. Thus, to measure the amount of energy given to an object, one must do more than simply determine its temperature change.
- B.
1. Air does not condense completely to a liquid when the temperature is lowered to  $-196^{\circ}\text{C}$ .
  2. We did change the diameter of the wire to obtain better results.
  3. The electrons do tend to flow from the point of lower potential to that of higher potential.
  4. It should be noted that certain alloys of iron do make stronger electromagnets than cast iron or hard steel.
  5. Franklin did demonstrate that atmospheric electricity and static electricity are one and the same thing.
  6. We can and do increase the productivity of labour by introducing new machines and methods of work.

## Многофункциональные слова

Выполняя различные функции в предложении, многофункциональные слова переводятся на русский язык по-разному.

### that

Указательное местоимение	Союз	Слово-заместитель упомянутого ранее существительного	Союзное слово
<p>They designed <b>that</b> part of the building efficiently.</p> <p><i>Они успешно спроектировали эту часть здания.</i></p>	<p>It is known <b>that</b> copper has a greater conductance than iron.</p> <p><i>Известно, что медь обладает большей проводимостью, чем железо.</i></p>	<p>The direction of a body's motion is the same as <b>that</b> of the force acting on it.</p> <p><i>Направление движения тела такое же, как и направление силы, действующей на него.</i></p> <p>The properties of gold are different from <b>those</b> of iron.</p> <p><i>Свойства золота отличаются от свойств железа.</i></p>	<p>You have to call the company <b>that</b> will be the prime user of the facility.</p> <p><i>Вы должны позвонить в компанию, которая будет основным пользователем данного сооружения.</i></p>

### ***1. Переведите следующие предложения на русский язык, определите функцию "that".***

1. It is known that the temperature of an object does not indicate the amount of energy contained in that object.
2. Semiconductors' electrical conductivity at ordinary temperature falls between that of metals and that of insulators.
3. The current flowing through the wire heats that wire.

4. Rihman established the rule that defines the temperature of a mixture consisting of two unequal masses of water at different temperatures.
5. The temperatures outside the steel superstructure were the same as those in the first test.
6. The mass of the Moon and, therefore, its gravitational attraction are much smaller than those of the Earth.
7. Dr. Black noticed that snow and ice absorb heat without getting hotter.
8. Newton formulated his three basic laws of motion that became the foundation of classical mechanics.
9. About the fifth century Democritus, a Greek philosopher, stated that all matter, as it seemed to him, is made up of particles that are called atoms and that the space between atoms is completely empty (a vacuum).

it

Личное местоимение	Указательное местоимение	Формальное подлежащее в безличных предложениях*	Вводное слово в предложениях с эмфатическим оборотом**
Nothing in the world moves faster than light. <b>It</b> moves at the rate of 300,000 km/sec. <i>Ничто в мире не движется быстрее света. Он движется со скоростью 300000 км/сек.</i>	I have just told them <b>it</b> was your project.  <i>Я только что сказал им, что это был ваш проект.</i>	<b>It</b> is important that the building be rebuilt.  <i>Важно, чтобы здание восстановили.</i>	<b>It</b> was in May when we received the new equipment.  <i>Именно в мае мы получили новое оборудование.</i>

\* В безличных предложениях в английском языке всегда имеется подлежащее, выраженное местоимением 'it', которое на русский язык не



переводится, так как не имеет смыслового значения и выполняет только функцию формального подлежащего.

It was easy to understand the speaker.

*Было легко понимать докладчика.*

In ancient times it was believed that the earth was flat.

*В древности думали, что земля плоская.*

It is important that the test be repeated.

*Важно, чтобы опыт повторили.*

\*\* Эмфатическая конструкция служит для выделения того или иного члена предложения.

Сочетание *it is (was)*, ... *who (that, which, whom ...)* ...выделяет любой член предложения кроме сказуемого. Выделяемый член предложения ставится после *it is (was)*, а оставшаяся часть образует придаточное предложение, вводимое союзом или союзным словом. Сочетание *it is (was)*, ... *who...* на русский язык не переводится, а все предложение передается простым предложением с усилительными словами «именно», «только».

It was in May when we received the new equipment.

Именно в мае мы получили новое оборудование.

***I. Определите функцию "it" и переведите предложения на русский язык.***

- A. 1. It is to be known that there exist many sources of energy in the world.  
2. It is one of the oldest bridges in New York.  
3. The energy of a body may be measured in either of the two ways: 1) by the work which it is capable of doing; 2) by the work which has been done upon it to bring it into condition in which it possesses energy.  
4. It is necessary to maintain a given, constant mass of gas at constant temperature and observe how the changing of pressure affects the volume to be occupied by this mass of gas.

5. Adhesion is the attraction between two surfaces in contact. It depends upon the areas in contact and is independent of the pressure.

6. But why had Faraday's previous experiments failed? It was because his magnets, wires, and coils had been stationary. It was only when the magnet was moving that an electric current was generated.

7. It should be recognized that computers are capable of doing repetitive operations.

8. A third mode of transference of heat is known as radiation. It is the process by which the heat of the sun reaches us, and it is exactly similar to the propagation of light.

9. It turns out that the strength of a magnetic field is proportional to the amount of current.

10. Liquids, except for liquid metals, are poor conductors of heat, but it does not mean, however, that they are incapable of conducting heat.

- B.
1. It is an accelerator that accelerates elementary particles of matter and imparts to them enormous energy.
  2. It was Rutherford who first proposed a general theory of radioactive transformation.
  3. It is in a transmission line that one should use as good a conductor as possible.
  4. It is the flow of current in the conductor of that device which produces a magnetic effect.
  5. It was Mendeleev who had spent twenty years studying the chemical elements.
  6. It is hydrogen, one of the elements composing water, that attracts the attention of scientists.
  7. It was not until the middle of the 19<sup>th</sup> century that the molecular-kinetic theory of gases found its further development.

8. It was not until October 4, 1957 that the world's first man-made satellite was launched.

9. It was not until 1765 that the first steam engine for industrial purposes was constructed by Polzunov.

10. It was not until 1930 that the first analog computer was built.

11. It was in 1820 that the first real calculating machine appeared.

### One

Числительное	Неопределенно-личное местоимение	Слово-заменитель упомянутого существительного
Many substances exist only in <b>one</b> state.  <i>Многие вещества существуют только в одном состоянии.</i>	<b>One</b> has to be careful while testing ventilators for conditioning rooms.  <i>Нужно быть внимательным при испытании вентиляторов, кондиционирующих помещения.</i>	Some materials are good conductors of heat and others are poor <b>ones</b> .  <i>Некоторые материалы – хорошие проводники тепла, а другие плохие.</i>

### ***I. Определите функцию "one" в следующих предложениях и переведите предложения на русский язык.***

1. One should distinguish between an electromotive force and a potential difference.

2. One can turn mechanical energy into electrical energy by using a generator.

3. There is but one method for investigating the properties of the substance under test.

4. A computer can be made more powerful by connecting a second processor to work in parallel with the first one.

5. Let's turn our attention to two properties of an electric current; one of them is resistance and the other one is self induction.
6. One of the most interesting phenomena was superconductivity, that is to say, the complete loss of resistance to electric current.
7. Everyday observations show that hot objects radiate much more heat than cold ones, the quantity of energy radiated increasing very rapidly with increased temperature.
8. A current of liquid or gas that absorbs heat at one place and then moves to another one where it mixes with a cooler portion of the fluid and loses heat is called a convection current.
9. One should remember the "Bernouilli effect" because it is one of the basic laws of thermodynamics.

### As

Наречие: как, в качестве	Союз: так как, ибо, когда, в то время как, по мере того как
<p>The steel structures are considered <b>as</b> being more safe.</p> <p><i>Стальные постройки считаются более безопасными.</i></p>	<p>This substance does not exist in a pure state <b>as</b> it is unstable.</p> <p><i>Это вещество не встречается в чистом виде, так как оно нестойкое.</i></p> <p>The viscosity of a liquid decreases <b>as</b> the temperature rises.</p> <p><i>Вязкость жидкости уменьшается, когда (по мере того, как) температура поднимается.</i></p>

### Запомнить:

- As...as**                      -так (же)...как
- as soon as**                -как только

<b>as long as</b>	-пока
<b>as far as</b>	-до, насколько
<b>so...as</b>	-с тем, чтобы
<b>as against</b>	-по сравнению
<b>as it is</b>	-фактически, действительно
<b>as well as</b>	-также, как
<b>as late as</b>	-уже, только
<b>as regards</b>	-относительно, что касается
<b>as a whole -</b>	-в целом
<b>as a matter of fact</b>	-фактически, на самом деле; в сущности, собственно говоря

***1. Определите функцию "as" и переведите предложения.***

1. As we have just seen, adding heat to a substance will not always cause a rise of its temperature.
2. As a body moves away from the surface of the earth, the force of gravity decreases.
3. The new building must occupy as large territory as it is possible.
4. The work done by the force can also serve as a measure of the change in internal work.
5. As the temperature of the liquid rises, the pressure of the vapour increases as does its volume.
6. As nobody knew whether the positive charges or the negative ones could freely move in a metal conductor, it was assumed that the current consists of moving positive charges.
7. As long as the current is steady, the magnetic effect does not represent any continuous expenditure of energy as does the heating effect.
8. As for conductivity in open air, air is found to be a conductor only when ionized.

9. In order to measure the quantity of heat it is necessary to select some substance as a standard.

10. The magnitude of the current as well as the voltage and resistance may vary from a minute amount to a very large quantity.

11. A biologist cannot do without knowledge of modern physics while a physicist must know something of biology as he may find a great deal of his work will be concerned with biophysics.

### But

Союз: но	Предлог: кроме	Наречие: только, лишь
The experiment was made for the second time, <b>but</b> the results obtained did not coincide.	All the cargo <b>but</b> one case of bricks arrived undamaged.	There is <b>but</b> one way for solving the problem.
<i>Эксперимент провели вторично, но полученные результаты не совпали.</i>	<i>Весь груз, кроме одного ящика с кирпичами, прибыл в неповрежденном состоянии.</i>	<i>Есть только один способ решения этой задачи.</i>

### Запомнить:

**all but**

-почти, едва не

**but for**

-если бы не; не будь

**the last but one**

-предпоследний

## For

<b>Союз: так как, ибо</b>	<b>Предлог: для, за, на, в течение</b>
<p>Wood is the richest source of cellulose <b>for</b> more than one half of its substance is cellulose fiber.</p> <p><i>Древесина является богатейшим источником целлюлозы, т.к. больше половины ее составляет волокно целлюлозы.</i></p>	<p>Steel is used <b>for</b> making different parts of machines.</p> <p><i>Сталь используют для изготовления различных деталей машин.</i></p> <p>Lodygin received a patent <b>for</b> his invention in America.</p> <p><i>В Америке Лодыгин получил патент на свое изобретение.</i></p> <p>This chemical process proceeds <b>for</b> two hours.</p> <p><i>Этот химический процесс происходит в течение двух часов.</i></p>

### Запомнить:

<b>for the rest</b>	-в остальном
<b>for all that</b>	-несмотря на все это, вопреки всему
<b>for once -</b>	-в виде исключения; на этот раз

### ***I. Переведите следующие предложения на русский язык, обращая внимание на функции "but" и "for".***

1. A thermometer shows the temperature of a substance but not the amount of internal energy in it.
2. The equipment under consideration will require but one worker to handle it.
3. Action and reaction always act on different bodies but never act on the same body.

4. The energy lost for work is not really lost but only converted into another form.
5. No machine can be made completely frictionless but the undesirable effects of friction can be reduced, of course.
6. Lavoisier demonstrated the law of the conservation of matter but in 1773.
7. All the devices but one were operating in a proper way.
8. All but five workers were dismissed.
9. Individual atoms and molecules cannot be seen by eye or even by high-powered optical microscopes for they are very tiny.
10. Edison worked at the improvement of the incandescent lamp for a long period of time for this problem interested him greatly.
11. Every engineer should be responsible for the job.
12. For the best illumination there were made two more windows.
13. A thermometer as its name indicates is an instrument to be used for measuring temperature.
14. The specialists came here for aerodynamic tests.
15. But for the opposition to the motion of a body, no force would be needed to change its position.
16. But for friction it would be impossible to control the motion of any machine.
17. The importance of X-rays was much greater to the whole of physics and natural knowledge for the discovery of X-rays provided the key not only to one but to many branches of physics.
18. He has been developing these ideas for a long time.
19. The need for smaller electronic component became really pressing.
20. The culmination of all the advancements was the microprocessor which has become virtually synonymous with microelectronics, but should not confused with it.
21. For 40 years the vacuum tube underwent constant improving and by 1947 it had come in so many different shapes and sizes and had performed many different functions.



### Before

<b>Союз: прежде чем, до того как</b>	<b>Предлог: до, перед</b>	<b>Наречие: раньше, прежде</b>
Helium was discovered on the sun <b>before</b> it was found on the earth.  <i>Гелий был обнаружен на солнце до того, как его нашли на земле.</i>	<b>Before</b> building the hospital, all the expenditures must be calculated.  <i>Все затраты должны быть подсчитаны до строительства этой больницы.</i>	That the brick is made of clay was known <b>before</b> .  <i>То, что кирпич сделан из глины было известно и раньше.</i>

### After

<b>Союз: после того, как</b>	<b>Предлог: после, за</b>	<b>Наречие: затем, потом, впоследствии</b>
It was necessary to paint the fence <b>after</b> the house was built.  <i>Необходимо было покрасить забор после того, как дом был построен.</i>	<b>After</b> the invention of the shaper James Nasmyth invented the steam hammer in 1839.  <i>После изобретения поперечно-строгального станка Джеймс Насмит изобрел в 1839 году паровой молот.</i>	Tell me, please, what did take place <b>after</b> .  <i>Расскажи мне, пожалуйста, что все-таки произошло потом.</i>

### Запомнить:

<b>after a while</b>	-через некоторое время
<b>shortly after</b>	-вскоре после (того, как)
<b>after all</b>	-в конце концов
<b>well after</b>	-значительно позже
<b>soon after</b>	-вскоре после этого

## Since

Союз: так как, с тех пор как	Предлог: с, после	Наречие: с тех пор
<p>Here the acoustical tests have been performed <b>since</b> the seismic activity stopped.</p> <p><i>Здесь акустические испытания проводятся с тех пор, как прекратилась сейсмическая активность.</i></p> <p><b>Since</b> the weight of a body is a force, it must be expressed in force units.</p> <p><i>Так как вес тела – это сила, его нужно выразить в единицах силы.</i></p>	<p>Here the acoustic tests have been performed <b>since</b> 1980.</p> <p><i>Акустические испытания проводятся здесь с 1980 г.</i></p>	<p>Whether they have been used continuously <b>since</b> then is not known.</p> <p><i>Неизвестно, используются ли они непрерывно с тех пор.</i></p>

## Only

Наречие: только, исключительно	Союз: но	Прилагательное: единственный
<p><b>Only</b> concrete can be used in realizing this project.</p> <p><i>Только бетон можно использовать при реализации этого проекта.</i></p>	<p>Gases can conduct heat <b>only</b> their conductivity is very low.</p> <p><i>Газы могут проводить тепло, но их проводимость очень низкая.</i></p>	<p>The <b>only</b> company that can build the rail bridge is "Edinbery Co".</p> <p><i>Единственная компания, которая может построить железнодорожный мост, – "Edinbery Co".</i></p>

***1. Определите функции "after", "before", "since", "only" и переведите предложения на русский язык.***

1. Never before has motion been so important as it is today.
2. The law of the conservation of matter had been discovered by Lomonosov many years before Lavoisier.
3. In a gas a molecule usually covers a distance corresponding to many molecular diameters before it collides with another molecule.
4. Before active combustion can take place, the substance to be burned must be raised in temperature...
5. After the train has passed a short distance from its starting point, it might, perhaps, cover only about 60 km per hour, its speed gradually increasing all the time.
6. After determining the number of amperes and volts one can find the resistance of the coil.
7. After the boiling point has been reached, the temperature of the water cannot be increased any more even if more heat were added.
8. After the London Exhibition of Physical Instruments in 1876, Yablochkov's invention was demonstrated many times at several other world exhibitions in Paris.
9. Since the boiling temperature of a liquid depends on the pressure above the liquid, one must be exact when speaking of the boiling point.
10. Since that time it has become the usual thing to speak of the current as flowing from positive to negative.
11. Since the electrons in the wire constitute the current flow, they will certainly tend to flow from the point of lower potential towards that of higher potential.
12. An electric current passes through a gas only when the molecules or atoms of the gas are ionized.
13. The only requirement consists in placing the rod in the field of the magnet.

14. All the transformations, the endless number of chemical changes that are always taking place are only changing energy from one form into another without affecting the total.
15. Kinematics is the only branch of physics which describes motion with respect to speed, time and distance.
16. Liquids can conduct heat only they are very poor conductors.

### Конструкция **the..., the...**

Конструкция **the+прилагательное (наречие) в сравнительной степени...**, **the+прилагательное (наречие) в сравнительной степени** переводится на русский язык **чем+прилагательное (наречие) в сравнительной степени, ...тем+прилагательное (наречие) в сравнительной степени.**

The greater the mass of a body and its velocity, the greater its kinetic energy.

*Чем больше масса тела и его скорость, тем больше его кинетическая энергия.*

### ***I. Переведите следующие предложения на русский язык.***

1. But the higher the temperature, the more molecules there will be in the vapour state.
2. The better you know the laws governing the transformation of matter and energy, the more you understand the fundamental relations between them.
3. The more satellites the scientists and engineers launch into space, the easier it will be to assemble orbital observatories.
4. The larger the diameter of the wire, the smaller the resistance is and, hence, the more current can flow through it.
5. Conductivity is obviously the opposite of resistance. At least, the greater conductivity a substance has, the less is its resistance.

6. The greater the electromotive force, the greater is the pressure on the electrons moving through the conductor.
7. The faster an object moves, the greater is air resistance.
8. From the second law of dynamics it follows that the greater the force and the smaller the mass of a body, the greater the acceleration imparted to the body.
9. The planets move in the orbits; the more slowly, the farther away they are from the sun.
10. The lower the centre of gravity, the greater is the stability of the body.

### **Составные предлоги**

<b>according to</b>	согласно
<b>because of</b>	из-за
<b>by means of</b>	посредством, при помощи
<b>by virtue of</b>	посредством, в силу, на основании
<b>due to</b>	благодаря, из-за
<b>in accordance with</b>	в соответствии с
<b>in addition to</b>	кроме, в дополнение к
<b>in case of</b>	в случае
<b>in spite of</b>	несмотря на
<b>owing to</b>	благодаря
<b>thanks to</b>	благодаря
<b>with respect to</b>	по отношению к, что касается

***1. Переведите следующие предложения на русский язык, обращая внимание на составные предлоги.***

1. *According to* this rule the wire used must have as large a cross-section as possible provided it is desirable to keep resistance as low as possible.

2. The kinetic energy of an object is the energy that it possesses *because of* its speed.
3. *In addition to* that, the space between the source of heat and the body to receive the heat does not rise in temperature.
4. In case it is necessary, a great part of the heat developed *due to* friction may be carried off by means of circulating water.
5. *Due to* friction we always get less useful work of a machine than we put into it.
6. The energy possessed by an object *owing to* its position is called potential energy.
7. The battery "a" in the emitter-base circuit makes the emitter positive *with respect to* the base.
8. But *in spite of* all these variations the volume of the water will remain the same provided the temperature is not changed.
9. Hence, *in case of* a solid bar we are able to measure the increase in length, width or thickness *due to* a given rise of temperature.
10. *In spite of* their having been compressed gases return to their original volume as soon as the applied force has stopped acting.
11. *In accordance with* the main laws of physics the viscosity of gases increases as the temperature rises.
12. Different liquids evaporate at different rates *because of* differences in their molecular attraction and in their molecular speeds.
13. If a force is parallel to the axis of moments or if it cuts the axis, then its moment *with respect to* the axis is zero.
14. *In spite of* all the hardships that he had to overcome Yablochkov continued working in the field of electricity to the day of his death.

## ОБЗОРНОЕ УПРАЖНЕНИЕ НА ПОВТОРЕНИЕ ГРАММАТИКИ

### *1. Переведите следующие предложения на русский язык.*

1. Scientists and mathematicians do help one another in making discoveries and solving problems.
2. It would take too much time to carry out complicated calculations unless the computers were constructed.
3. Germanium was predicted by Mendeleev, the German scientist Winkler discovering it seventeen years later.
4. Variations of current flowing in one part of the transistor circuit are known to cause corresponding changes in the other part of the circuit.
5. Electrons can be made to travel at very high speeds.
6. Popov's having invented the radio is well-known to everybody.
7. A gas is generally considered to have two definite specific heats, depending on the manner in which it is heated. A gas may be heated at constant volume or it may be heated at constant pressure, each method giving a different value for the specific heat.
8. Lasers proved to be of great help in medicine and industry.
9. The conductivity of minerals and crystals increases with heating and falls with cooling.
10. When manufactured with a controlled amount of arsenic impurity, germanium is called *n*-type germanium, the letter *n* standing for negative.
11. The work of Rutherford followed by great research work of many other scientists is known to every physicist.

12. A gas being heated at constant volume, no work is done by it, as there is no change of volume. The specific heat to be obtained by this method of heating is known as the specific heat at constant volume.
13. We know the transformer to be an apparatus designed for changing the alternating voltages and currents by means of magnetic induction, the frequency remaining unchanged.
14. Transformers being generally used only with alternating current, there is no need to make and break the circuit.
15. The amount of energy to be consumed by the motor is equal to that put into the motor.
16. Some gaseous reactions are not all influenced by changes in pressure.
17. To produce a current by chemical reaction an alkali or an acid is made to react with a metal. The device to be used is called a voltaic or an electric cell, a group of two or more cells connected together forming a battery.
18. The current decreasing, an e.m.f. is induced in the direction which coincides with that of the current, thus opposing the decrease of current.
19. If we were asked to prove the existence of a connection between electricity and magnetism, we could not do better than point to the electromagnet. It is flow of current in the conductor of that device which produces a magnetic effect.
20. Unless the scientists had developed atomic clocks, we wouldn't have had so accurate standard of time.
21. At any rate, the sum total of the chemical energy is computed to equal the sum total of all the other forms of energy into which it is converted.
22. Simulating a historical situation involves making decisions, role play, sometimes co-operation.



23. The flow of electrons from the zinc plate to the copper plate in the external circuit was found to represent electrical energy.
24. When acting upon an elastic body that changes its original form, the external force is opposed by forces acting within a body.
25. It is the e.m.f. that moves electrical charges from one point in the circuit to another.
26. The weight of a body on the surface of the earth may vary from place to place because for bodies on the surface the nearer the body is to the centre of the earth the greater is the force of gravity and the greater is its weight.
27. An iron wire of the same size and length as a copper one is observed to have a greater resistance than that of the copper wire. At any rate, under the same conditions the copper wire will allow more current to flow than the iron wire does.
28. It is supposed that the electromotive force is named so because of the idea that it "forces" the current through the circuit.
29. Holding a heavy object stationary does not transfer energy to it because there is no displacement.
30. It would be quite wrong to think that conducting materials are the only materials to be used for power transmission.
31. The third law is important in statics because it permits complex structures and machines to be separated into simple units to be analyzed individually with the least number of unknown forces.
32. Epinus was the first to apply mathematics to the study of electricity and magnetism. But what interests us most is that he first investigated the phenomenon known at present as that of electrostatic induction.

33. In physics mass is quantitative measure of inertia. It is the resistance that a body offers to a change in its speed or position upon the application of a force. The greater the mass of a body, the smaller the change produced by an applied force.

34. Adding heat to a boiling liquid we make it change its state without altering its temperature. The quantity of heat required to transform the unit mass of a substance from the liquid state into vapour without changing temperature is known to be called latent heat of vaporization of the substance.

35. The strain in a body exceeding a certain value, the body will not recover completely its original state when the acting force is removed. A body strained beyond the elastic limit may not recover completely its original state when strained for a long time.

36. In 1820 Oersted published his discovery which was followed by a great number of researches conducted in many countries by many physicists and among them was Ampere.

37. The discovery of X-rays was followed by a number of unexpected discoveries like that of radioactivity in 1896, of the structure of crystal in 1912, of the neutron in 1932 ...

Таблица 11

Степени сравнения прилагательных и наречий

		<i>Положительная</i>	<i>Сравнительная</i>	<i>Превосходная</i>
Прилагательные	<i>Односложные</i>	long easy	longer easier	<u>the longest</u> <u>the easiest</u>
	<i>Многосложные</i>	difficult active	<u>more</u> difficult <u>more</u> active	<u>the most</u> difficult <u>the most</u> active
	<i>Исключения</i>	good bad little *far	better worse less farther/ further	the best the worst the least the farthest/ furthest
Наречия		fast hard soon early easily actively	faster harder sooner earlier <u>more</u> easily <u>more</u> actively	<u>fastest</u> hardest soonest earliest <u>most</u> easily <u>most</u> actively
	<i>Исключения</i>	well badly much little far	better worse more less farther/ further	best worst most least farthest/ furthest

## Сравнительные конструкции

Предметы или лица имеют одинаковую степень качества.	<p><b>This box is as heavy as that one.</b>  <i>Этот ящик такой же тяжелый, как и тот.</i></p>
Предметы или лица имеют неодинаковую степень качества.	<p><b>This box is not so (as) heavy as that one.</b>  <i>Этот ящик не такой тяжелый, как тот.</i></p> <p><b>This box is less heavy than that one.</b>  <i>Этот ящик менее тяжелый, чем тот.</i></p> <p><b>This box is twice as heavy as that one.</b>  <i>Этот ящик в два раза тяжелее того.</i></p> <p><b>This box is half as heavy as that one.</b>  <i>Этот ящик в два раза легче того.</i></p> <p><b>This box is half the weight of that one.</b>  <i>Этот ящик в два раза легче того.</i></p>

## Структура общего вопроса

Вспомогательный глагол, модальный глагол	Подлежащее	Сказуемое (или его часть)	Второстепенные члены предложения	Ответ на вопрос
Is	your friend	a student?		Yes, he is.
Are	you	reading	a book now?	No, I am not.
Do	our students	go	to the sports – grounds?	Yes, they do.
Does	Kate	live	in Minsk?	No, she does not.
Did	you	see	that film yesterday?	No, I did not.
Do	they	have	these devices?	Yes, they do.
Has	his friend	translated	the text?	Yes, he has.
Shall	we	go	to the cinema today?	No, we shall not.
Must	we	read	newspapers every day?	Yes, we must.

## Структура специального вопроса

Вопросительное слово	Вспомогательный глагол, модальный глагол	Подлежащее	Остальная часть сказуемого	Второстепенные члены предложения
Where	do	you	go	every morning?
What	can	one	get	in the library?
What book	did	you	read	yesterday?
What	is	he	doing	now?
Why	were	you	absent	yesterday?
When	will	you	go	to London?
When	do	you	have to leave	for London?

## Структура вопроса к подлежащему или к определению подлежащего

Вопросительное слово-подлежащее или определение подлежащего	Сказуемое	Второстепенные члены предложения
Who	is absent	today?
Whose book	is	on the table?
What	is	on the desk?
What season	comes	after summer?
Who	will go	to the theatre?
Who	saw	the film yesterday?
Who	is speaking?	
Who	has been	to London?

### Структура разделительного вопроса

Вопрос	Ответ, выражающий	
	согласие	несогласие
Your friend speaks English, doesn't he?	Yes, he does	No, he doesn't
You have finished your work, haven't you?	Yes, I have	No, I haven't
Your friend doesn't speak English, does he?	No, he doesn't	Yes, he does.
You haven't finished your work, have you?	No, I haven't	Yes, I have.

## СОДЕРЖАНИЕ

СЛОВООБРАЗОВАНИЕ	4
СЛОВОПРОИЗВОДСТВО ПРИ ПОМОЩИ ИЗМЕНЕНИЯ МЕСТА УДАРЕНИЯ.	6
СЛОВОПРОИЗВОДСТВО ПРИ ПОМОЩИ ЧЕРЕДОВАНИЯ ЗВУКОВ.	6
МЕСТОИМЕНЕНИЯ MANY, MUCH, FEW, LITTLE	11
НЕОПРЕДЕЛЕННЫЕ И ОТРИЦАТЕЛЬНЫЕ МЕСТОИМЕНЕНИЯ	11
ОСНОВНЫЕ ФОРМЫ ГЛАГОЛА	14
ЛИЧНЫЕ И НЕЛИЧНЫЕ ФОРМЫ ГЛАГОЛА.	14
ФУНКЦИИ ГЛАГОЛА <i>TO BE</i>	15
ОБОРОТ <i>THERE IS/ARE.</i>	17
ФУНКЦИИ ГЛАГОЛА <i>TO HAVE</i>	19
СТРАДАТЕЛЬНЫЙ ЗАЛОГ	21
МОДАЛЬНЫЕ ГЛАГОЛЫ	26
СОЧЕТАНИЕ МОДАЛЬНЫХ ГЛАГОЛОВ С ИНФИНИТИВОМ В СТРАДАТЕЛЬНОМ ЗАЛОГЕ	27
СОЧЕТАНИЕ МОДАЛЬНЫХ ГЛАГОЛОВ С ПЕРФЕКТНЫМ ИНФИНИТИВОМ	28
ВИДО ВРЕМЕННЫЕ ФОРМЫ АНГЛИЙСКОГО ГЛАГОЛА В АКТИВНОМ ЗАЛОГЕ	32
ВИДО-ВРЕМЕННЫЕ ФОРМЫ АНГЛИЙСКОГО ГЛАГОЛА В СТРАДАТЕЛЬНОМ ЗАЛОГЕ	33
СТРУКТУРА ПРОСТОГО ПОВЕСТВОВАТЕЛЬНОГО РАСПРОСТРАНЕННОГО ПРЕДЛОЖЕНИЯ.	37
АНАЛИЗ СЛОЖНОГО ПРЕДЛОЖЕНИЯ	40
ИНФИНИТИВ	44
СЛОЖНЫЕ ОБОРОТЫ С ИНФИНИТИВОМ	48
СЛОЖНОЕ ПОДЛЕЖАЩЕЕ (ИЛИ ИМЕНИТЕЛЬНЫЙ ПАДЕЖ С ИНФИНИТИВОМ)	48
СЛОЖНОЕ ДОПОЛНЕНИЕ (ИЛИ ОБЪЕКТНЫЙ ПАДЕЖ С ИНФИНИТИВОМ)	50
ИНФИНИТИВНЫЙ ОБОРОТ С ПРЕДЛОГОМ "FOR"	52
ПРИЧАСТИЕ. ФОРМЫ ПРИЧАСТИЯ	61
ФУНКЦИЯ ОПРЕДЕЛЕНИЯ	62
ФУНКЦИЯ ОБСТОЯТЕЛЬСТВА	64

<b>НЕЗАВИСИМЫЙ ПРИЧАСТНЫЙ ОБОРОТ</b>	<b>66</b>
<b>СЛОЖНОЕ ДОПОЛНЕНИЕ (ИЛИ ОБЪЕКТНЫЙ ПАДЕЖ) С ПРИЧАСТИЕМ</b>	<b>68</b>
<b>СЛОЖНОЕ ПОДЛЕЖАЩЕЕ (ИЛИ ИМЕНИТЕЛЬНЫЙ ПАДЕЖ) С ПРИЧАСТИЕМ</b>	<b>69</b>
<b>ГЕРУНДИЙ. ФОРМЫ И ФУНКЦИИ ГЕРУНДИЯ</b>	<b>76</b>
<b>ГЕРУНДИАЛЬНЫЙ КОМПЛЕКС (СЛОЖНЫЙ ГЕРУНДИАЛЬНЫЙ ОБОРОТ)</b>	<b>79</b>
<b>СРАВНЕНИЕ ГЕРУНДИЯ И ПРИЧАСТИЯ</b>	<b>81</b>
<b>СОСЛАГАТЕЛЬНОЕ НАКЛОНЕНИЕ. ФОРМЫ СОСЛАГАТЕЛЬНОГО НАКЛОНЕНИЯ</b>	<b>86</b>
<b>УПОТРЕБЛЕНИЕ СОСЛАГАТЕЛЬНОГО НАКЛОНЕНИЯ</b>	<b>87</b>
<b>УСЛОВНЫЕ ПРЕДЛОЖЕНИЯ</b>	<b>88</b>
<b>МНОГОФУНКЦИОНАЛЬНЫЙ ГЛАГОЛ "TO DO"</b>	<b>94</b>
<b>МНОГОФУНКЦИОНАЛЬНЫЕ СЛОВА</b>	<b>96</b>
<b>КОНСТРУКЦИЯ THE..., THE...</b>	<b>109</b>
<b>СОСТАВНЫЕ ПРЕДЛОГИ</b>	<b>110</b>
<b>ОБЗОРНОЕ УПРАЖНЕНИЕ НА ПОВТОРЕНИЕ ГРАММАТИКИ</b>	<b>112</b>



Учебное издание

КИПНИС Инна Юрьевна  
ХОМЕНКО Светлана Анатольевна

Грамматические особенности перевода английского научно-  
технического текста

Грамматический справочник

Ответственный за выпуск Т.А. Подолякова

---

Подписано в печать 04.10. 2010.

Формат 60X84 1/16 .Бумага офсетная.

Отпечатано на ризографе. Гарнитура Таймс.

Усл. печ. л. 7,09. Уч. - изд. л. 5,55. Доп. тираж 300.

Заказ 1341.

---

Издатель и полиграфическое исполнение:

Белорусский национальный технический университет.

ЛИ № 02330/0494349 от 16.03.2009.

Проспект Независимости, 65. 220013, Минск.

АНГЛИЙСКИЙ ЯЗЫК  
для студентов технических вузов  
Основной курс  
В 2 частях  
Часть 1

Под общей редакцией  
кандидата филологических наук доцента  
С. А. Хоменко  
кандидата педагогических наук доцента  
В.Ф. Скалабан

*Допущено Министерством образования  
Республики Беларусь  
в качестве учебного пособия для студентов  
технических специальностей учреждений,  
обеспечивающих получение  
высшего образования*

*2-е издание, исправленное*

Минск  
"Вышэйшая школа" 2006

## ПРЕДИСЛОВИЕ

Учебное пособие предназначено для студентов технических специальностей вузов и направлено на развитие языковых и коммуникативных навыков в сферах социально обусловленного и профессионально-ориентированного общения.

Пособие состоит из 2 частей, рассчитано на 210 часов учебного времени. Его структуру составляют 18 учебных разделов (Units), материал для повторения (Check Your Progress), представленный после 6, 12, 18 разделов, грамматический справочник (Grammar), активный лексический словарь (Active Vocabulary), материал для дополнительного чтения и перевода (Supplementary Reading) и приложения (Most Frequently Used Abbreviations, Units of Measurement, Conjunctions, List of Irregular Verbs, Spelling, Word Formation, Most Frequently Used Prepositions, Conjunctions and Adverbs).

В первую часть, рассчитанную на 140 часов аудиторного времени, вошли 12 учебных разделов, относящиеся к ним материал повторения и грамматический справочник, а также пять приложений.

Каждый раздел состоит из 2 частей (Sections), каждая включает введение в тему (Lead-in); упражнения, предназначенные для формирования языковых навыков (Language Practice), задания для обучения чтению и говорению (Reading and Speaking), для активизации речи (Activity) и для обучения письменной речи (Writing).

С 7-го раздела вводится второй текст для чтения (Further Reading), что позволяет обеспечить индивидуальный и дифференцированный подход к обучению английскому языку в техническом вузе.

Текстовый материал заимствован из зарубежных источников и его тематика определена программой подготовки специалистов технического профиля.

Комплекс заданий основан на функционально-коммуникативном подходе, предполагает взаимосвязанное обучение всем видам речевой деятельности. Он реализует определенные

коммуникативные задачи в ситуациях социально обусловленного и профессионально-ориентированного общения и направлен на формирование коммуникативно-компетентной личности инженера.

Раздел "Grammar" содержит краткие сведения о грамматическом материале, включенном в учебные тематические циклы, который активизируется комплексом упражнений, представлен в конце книги к каждому учебному разделу.

Раздел "Supplementary Reading" с комплексом заданий на предтекстовом и послетекстовом уровнях способствует активизации речемыслительной деятельности студентов и развитию стабильных коммуникативных умений в профессионально ориентированных сферах общения.

Учебное пособие может быть рекомендовано для самостоятельного изучения языка.

Авторы выражают искреннюю благодарность рецензентам:

доценту кафедры методики преподавания иностранных языков Минского государственного лингвистического университета кандидату педагогических наук Пониматко А.П. за ценные советы и замечания, которые были учтены при доработке рукописи;

доценту, кандидату филологических наук, заведующей кафедрой английского языка естественных факультетов Белорусского государственного университета Лукше Т.Г., а также коллективу кафедры;

коллективу кафедры английского языка № 1 Белорусского национального технического университета за апробацию учебного пособия в экспериментальных группах.

*Авторы*

# Unit One

## ENGINEERING

### *Section A. An Engineering Student*

Lead-in

**I. List the main branches of engineering. Compare your list with that of your groupmates.**

**II. You are a student at the University now. Listen to the dialogues you can hear at the University during your first days of studying and team how to introduce yourself**

#### **A**

*Teacher:* Good morning! Let me introduce myself. I am your English teacher. I am here to help you with English. What are you? What do you do? Why are you here?

*Class:* We are students.

*Teacher:* Are you first-year students? Are you freshmen?

*Class:* Yes, we are.

*Teacher:* Will you introduce yourselves? Who are you?

*Student:* I am Andrew Kovalev. I am here to study English.

*Teacher:* What is your name?

*Student:* My name is Kate Gomonova. I am a first-year student.

I am here to master my English, too.

*Teacher:* Thank you. I am glad to meet you.

*Students:* We are glad to meet you, too.

#### **B**

*Teacher:* Allow me to introduce your supervisor.

*Supervisor:* How do you do?

*Students:* How do you do?

*Supervisor:* You are eager to study at our Technical University and become good specialists, aren't you?

*Students:* Yes, of course, we are.

*Supervisor:* You are lucky to study at our University. I wish you success.

*Students:* Thank you very much.

### C

*Teacher: (in whisper)* Oh, I'm sorry, who is this student?

*Monitor:* This is Oleg Smirnov.

*Teacher:* I see. He is 18 years old, isn't he?

*Monitor:* Yes, he is.

*Teacher:* Is he from Moscow?

*Monitor:* No, he isn't. He is Belarusian. He is from Grodno, from the Republic of Belarus.

*Teacher:* OK. Thanks a lot.

### D

*Oleg:* Hello, Kate. How are you?

*Kate:* Very well, thank you. And how are you?

*Oleg:* Quite well, thanks. Kate, this is Mike. He is my friend here at the University and he was my friend at school.

*Kate:* Hello, nice to meet you.

*Mike:* Hi, I'm glad to meet you, too.

### III. That's how we greet and introduce each other in English. Study this table.

Good { morning afternoon evening	Good { morning afternoon evening
Hello.	Hello.
How do you do?	How do you do?
How are you?	I'm fine, thank you.
How are you doing?	I'm OK, thanks.
How are you getting on?	Not bad.
How are things?	Quite well.
Is everything fine?	Excellent, thanks.
Let me introduce myself.	Nice to meet you.
My name is ...	Pleased to meet you.
	I am ...
This is Mr., Mrs., Miss...	Glad to meet you. ...

#### IV. Complete the dialogues using the expressions from the table (page 6).

- a) - Good morning!  
-...  
-How are you today?
- b) -Let me introduce your new lecturer. Her name is ....  
-...  
-How do you do?
- c) -...  
-Nice to meet you. I'm ...  
-...
- d) -...  
-I am a first-year student.  
-Where are you from?  
-...

### Language Practice

#### I. Imagine Kate and Mike or other students of the group are talking.

##### A. Put in *is / am / are* and reproduce the dialogues.

- a) *Kate*: Excuse me, are you Paul?  
*Michael*: No, I... . My name ... Michael.  
*Kate*: Well, Mike, are you tired after your first day at the University?  
*Michael*: No, I ..., really. I... eager to study here.  
*Kate*: Me too. They say the Technical University ... a very exciting University to attend.
- b) *Andrew*: I... Andrew Kovalev. I... fond of computers. And you?  
*Alice*: I... Alice. I... fond of programming as well. And besides, I... interested in graffiti arts.  
*Andrew*: What is it?
- c) *Ann*: Alexei, you ... good at drawing.  
*Alexei*: Really? I... glad to hear it.

##### B. Fill in the gaps with the proper words.

- Are... British?  
-No, ... am not. I'm ....  
-Are ... from ...?  
-No, ... am not. I'm from ....



- Is ... friend also from ...?
- Yes, ... is. ... are really good friends.

## II. Correct mistakes in the passage.

Hello! We am first-year students of the Technical University. Our names is Oleg, Mike and Kate. We is eager to know what it am like to be an American student. We is from Minsk. Minsk am the capital of Belarus. Minsk are about 750 kilometers far from Moscow. The transportation system in Minsk are rather complicated.

The average temperature in Belarus in winter months are about **-10°C (14°F) and about +20°C (68°F) in summer months.**

## III. Put all possible questions to the following statements. Consult the table.

---

	<i>He is a teacher.</i>
	<i>Is he a teacher</i>
	<i>Is he a teacher or a student?</i>
<i>What</i>	<i>is he?</i>
	<i>He is a teacher, isn't he?</i>

---

1. She is a programmer.
2. Hans is an electrician.
3. They are workers.
4. Paul is a technical student.
5. We are first-year students.

## IV. Study the following expressions in the frame and fill in the gaps.

---

to be afraid *of*, to be good/bad *at*, to be tired *of*,  
 to be busy *with*, to be surprised *at*, to be impressed *by*,  
 to be bored *with*, to be fed up *with*, to be interested *in*,  
 to be fond *of*, to be crazy *about*, to be proud *of*

---

1. Tom is impressed ... the design of this tower.
2. They are fond ... geography.
3. I'm fed up ... this task.
4. We are busy ... our home task.
5. He isn't interested ...: physics.
6. Our classmates are crazy ... programming.

**V. You know very little about your group mates and you'd like to learn more about them. Ask them different questions using the expressions from the previous exercise.**

EXAMPLE: - What are you interested in?  
- I'm interested in mechanical engineering.

**VI. Make up sentences using the "Word Order Rule". Consult Grammar on page 262.**

- 1.freshmen the University at are we.
- 2.are students technical we.
- 3.fond of music am I.
- 4.are interested in we engineering.
- 5.good at are they programming.
- 6.never tired of we studying are.

**VII. Study the names of different professions.**

- 1.He is a student of computer engineering. So he is a programmer.
- 2.He is a student of processing engineering. So he is a technologist.
- 3.He is a student of metrology. So he is a metrologist.
- 4.He is a student of economics. So he is an economist.
- 5.He is a student of construction engineering. So he is a builder.
- 6.He is a student of mechanical engineering. So he is a mechanical engineer.

**VIII. Name the specialists who work in these areas.**

physics - \_\_\_\_\_  
ecology - \_\_\_\_\_  
technology - \_\_\_\_\_  
economy - \_\_\_\_\_  
mathematics - \_\_\_\_\_  
metrology - \_\_\_\_\_  
programming - \_\_\_\_\_  
architecture - \_\_\_\_\_

**IX. Fill in the gaps. The first one is done for you.**

- a)a metrologist metrology
- b)a physicist ...
- c)... chemistry
- d)a mathematician ...
- e)a technologist ...

- f) an architect ...  
 g)... civil engineering  
 h)... machine-building industry  
 i) an economist ...

**X. You are probably familiar with the following jobs: physician, physicist, accountant, etc. Which description fits which job?**

- 1.physician a) a student or expert in physics  
 2.physicist b) a person whose profession is to keep and examine  
 3.accountant business accounts  
 4.technician c) a specialist in scientific and industrial fields  
 5.technologist d) a doctor of medicine or surgery  
 e) a skilled workman, especially who repairs

**XI. Match the expressions from the columns to form synonyms. Use the dictionary if necessary.**

- |               |                       |
|---------------|-----------------------|
| excellent     | a second-year student |
| a sophomore   | terrible              |
| to be         | attractive            |
| interested in | a first-year student  |
| horrible      | to be fond of         |
| beautiful     | I'm fine              |
| I'm great     | brilliant             |
| a freshman    |                       |

**XII. Find and correct mistakes in the following sentences.**

- How are you do?  
— Quite well, thank you.
- Let me to introduce myself. My name's Alex Frolov.
- He is fond in computers.
- My best friend isn't interested at graffiti arts.
- He's crazy of programming.
- I'm really well at Chemistry.
- Mark is a student of technology. He's a technician.
- My mother's friend is a doctor. She is a physicist.

**XIII. Translate the following sentences into English.**

- Позвольте представиться. Я - мистер Гейтс, Ваш преподаватель английского языка.
- Мы — студенты технического университета.
- Он - студент первого курса и очень увлекается компьютерами.
- Он учится на 3-м курсе.

5. Как вы поживаете? - Спасибо, хорошо.
6. Откуда Джон? - Джон из Лондона, он англичанин.
7. Олег, это мой хороший друг Павел. - Добрый день. – Добрый день.
8. - Кто это? - Это Ганс Шмидт. - Кто он? - Он - студент-первокурсник электротехнического факультета. - Кто он по национальности? - Он немец.
9. Олег из Минска, он белорус.
10. Чем занимается твой друг? - Он механик и студент машиностроительного факультета. Он хорошо разбирается в физике.
11. Он женат или холост?
12. Сколько ему лет?

## Reading and Speaking

I. These are short texts about different young people. Read them and answer the questions.

*This is Mr. Glidden.* He is a teacher. He is at school now. He is 25. He is married. He is from Glasgow. He is British.

1. Is this Mr. Glidden?
2. Is he a teacher or a technician?
3. Is he married or single?
4. How old is he?
5. Is he from Glasgow?
6. He is British, isn't he?



*This is Alice Evans.* She is a first-year student. She is only 17. She is in class now. She isn't married. She is from New York. She is American.

1. Who is this?
2. Is she a first or a third-year student?
3. Is she 20?
4. Is she from New York?
5. She isn't married, is she?
6. She is American, isn't she?

*He is Hans Schmidt.* He is an electrician. He is also a part-time student of electrical engineering. He is at work now. He is 22. He isn't married. He is from Bremen. He is German. 1. Who is he?

2. What does he do?
3. What's his age?
4. Is he a full-time or a part-time student?
6. What nationality is he?



*This is Paul Dimitrov.* He is a mechanic. He is also a student of mechanical engineering. He is in his second year. He isn't on holiday. He is 19. He is from Moscow. He is Russian.

1. Is this Paul Dimitrov?
2. What is he?
3. Is he interested in science or engineering?
4. Is he a freshman or a sophomore?
5. Is he at work or on holiday?
6. He is Russian, isn't he?



*This is Oleg Smirnov.* He is a programmer. He is also a fifth-year student of electronic engineering. He is a student of correspondence department. He is 30. He is married. He is from Minsk. He is Belarusian.

1. Who is this?
2. What does he do?
3. Is he a graduate or undergraduate?
4. He is a senior student, isn't he?
5. Where is he from?
6. What nationality is he?



II. a) Read about Jan Muller.

My name's Jan Muller. I'm twenty and I'm single. I have a younger sister, she is a schoolgirl. I am from Germany, and I live in Munich. I am a third-year student at the Engineering Faculty of the Technical University. Apart from this, I'm interested in computers. I'm satisfied with the standard of teaching at the University, and, as a rule, our graduates are highly-qualified specialists. As for me, I'd like to get a well-paid job. That's why I also learn English and have a good command of it.

b) Define true and false sentences.

1. Jan is a postgraduate student.
2. He isn't married.
3. He has two brothers.

4. Jan is from Norway.
5. He studies programming.
6. He speaks two foreign languages.

**c) Choose the right option according to the story about Jan Muller.**

1. Jan Muller is a ... .  
 a) freshman                      b) sophomore              c) junior student
2. His younger sister studies at...  
 a) University                      b) school              c) college
3. He is interested in ... .  
 a) computers              b) foreign languages      c) travelling
4. Jan is a student of ....  
 a) mechanical engineering      b) electrical engineering      c) civil engineering
5. He wants to learn English because he ....  
 a) is fond of foreign languages      b) is interested in computers  
 c) wants to get a well-paid job

**d) Say what you have learned about Jan Muller using the following expressions.**

- |                     |                       |
|---------------------|-----------------------|
| to be ... years old | to be interested in   |
| to be married       | qualified specialists |
| to be from          | to be good at English |
| to be a student of  | a well-paid job       |

**Activity**

**I. a) There are a lot of international students at your University. Let's interview one of them, Alexey Petrenko.**

- I: Hello. Can you introduce yourself?  
 A: Yes, sure. My name's Alexey.  
 I: Would you, please, say your full name?  
 A: Actually, Alexey is my first name. And my surname is Petrenko. So, it's Alexey Petrenko .  
 I: You are a foreigner, aren't you?  
 A: Right you are. I'm not Belarusian.  
 I: Where are you from?  
 A: I'm from the Ukraine.  
 I: How old are you?  
 A: I'm nineteen.

I: So, you are an undergraduate student, aren't you?  
A: Yes, I am. I am a first-year student. I study programming.  
I: Are you fond of it?  
A: Certainly, I am. I'm absolutely crazy about it.  
I: Then, good luck, Alexey. And thank you so much for your answers.

**b) Act out the dialogue from ex. 1a).**

**II. There is a new foreign student in your group, Ryan Jones by name. Learn about him as much as you can.**

Ryan is eighteen years old  
not married  
a first-year student  
from Ireland  
he is a student at the Mechanical Engineering Faculty

**III. You are a participant at the International Students Conference in the Netherlands. Your new friends are from Germany, Sweden and Italy. They are all technical students. Make up a conversation with them using the expressions and words from Section A.**

**Writing**

**I. This is how we write letters in English. Study this example.**

Martha is a German student who studies in Brighton. Read her letter to Gerhard, her friend in Germany.

*We begin with Dear...*



Dear Gerhard,

*Address, date*



34 Royal Street  
Brighton 17S  
25<sup>th</sup> September

How's life? I'm well. Now I'm in Brighton. I am a student of Mechanical Engineering Faculty here at the Polytechnic. There are 12 students in our group. They are from different countries -France, Russia, Turkey, the Ukraine, Syria, Bulgaria, and Belgium.

All of them are very friendly. We are happy to study together. And our teachers are brilliant.

My address is at the top of the letter. I live in the hostel on campus. My roommate is a sophomore and we are really good friends. She is fond of physics as well as I am.

I'm really impressed by the size of our University. The buildings are very modern here. The students' canteen is very noisy and always full of hungry students. British food is tasty, but coffee is terrible here.

I'm really eager to study at this University but frankly speaking, I miss home.

Write to me back soon.

Best wishes,

Martha.



*Ending ( Regards, Love) Signature*

**II. Write a similar letter to your friend about your first days at the University.**

*Section B. Some (geometrical Figures*

### **Lead-in**

**I. Is Geometry a very important subject for engineering? Name the most important geometrical figures.**

**II. Now let's revise some geometrical figures.**

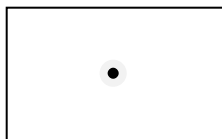

Number 1 is a point.

This is a point.

What is this?

This is a point.



What is number 2?  
Number 2 is a line.  
What is that?  
That is a line.  
That line is straight.

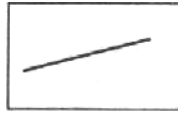

What is this?  
This is a curve.  
Is this a curve?  
Yes, it is. Is it open?  
Yes, it is.

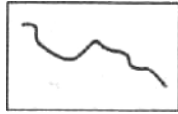

What are these?  
These are circles.  
Are these circles?  
Yes, they are.  
These circles are large.  
Are these circles large?  
Yes, they are.



What are those?  
Those are squares.  
Those are squares, aren't they?  
Yes, they are. They are squares.  
Those squares are small.

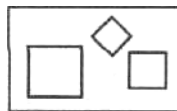

## Language Practice

### I. Change singular into plural and plural into singular.

1. This is a tyre.
2. Those are pipes.
3. That is a wheel.
4. These are acute angles.
5. This is a straight line.
6. Those are matches.

### II. a) Study this picture and learn the names of different tools,

a) goggles



b) spanners



c) pincers      f) nails

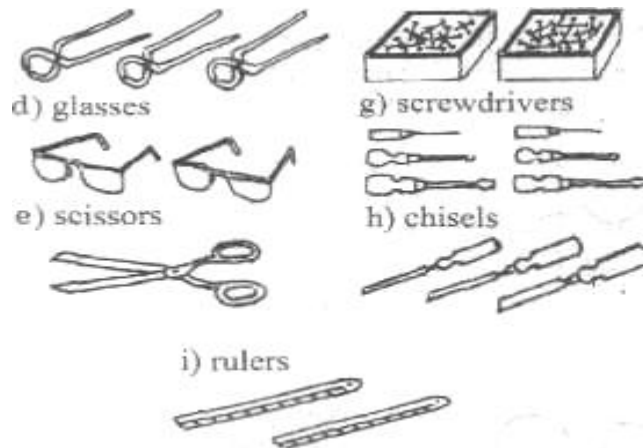

**b) Close the book and try to name as many tools as possible.**

**III. Make up sentences with the following expressions: a pair of, a set of, a box of, a packet of.**

EXAMPLE: a) *pliers*

These are pliers. This is a pair of pliers.

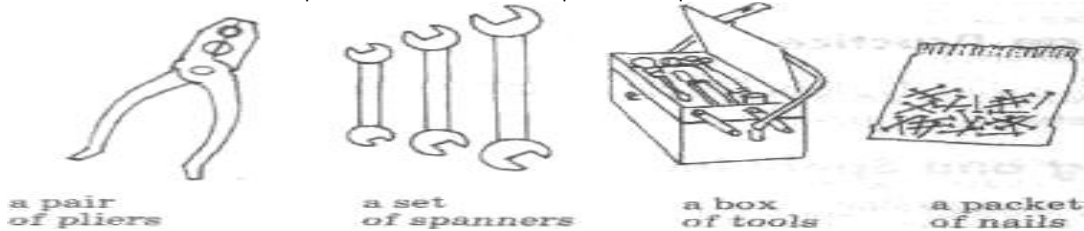

- a) pliers
- b) pincers
- c) scissors
- d) goggles

- e) glasses
- f) spanners
- g) screwdrivers
- h) chisels

- i) rulers
- j) tools
- k) matches
- l) drills

- m) nails
- n) screws
- o) nuts
- p) bolts

IV. Look at the chart below. Choose the right tool for each profession.

EXAMPLE: A screwdriver is for electricians. Screwdrivers are for electricians.

pliers	is	for	electricians
spanner			carpenters
screwdriver	are	for	mechanics
chisel			joiners
ruler			
nails			
screws			
nuts			
bolts			

V. Find and correct mistakes in the following sentences.

- What is this? - This is curves.  
3. This chisels are new.
- Are these containers full of water? - Yes, them are.

VI. Translate the following sentences.

- Это квадрат.
- Те трубы длинные.
- Что это? - Это шина. Она узкая.
- Это колеса. Они большие.
- Другими словами, этот угол прямой.
- Это линия? - Правильно. Эта линия прямая.
- Это тоже угол, но он острый.
- Что это? - Это плоскости. Они параллельные.
- Это кривые, не так ли?
- Эти емкости полные.

### Reading and Speaking

I. Read the texts and answer the questions.

Number 1 is an angle.

This is an angle.

It is acute.

In other words, this angle is acute.

1. What is this?

2. Is it an acute angle?

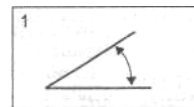

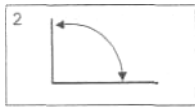

Number 2 is also an angle.  
That is also an angle.  
But it is not acute.  
It is right.  
In other words that angle is a right angle.

- 1.What is that?
- 2.Is it also an acute angle?
- 3.It is a right angle, isn't it?

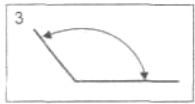

Number 3 is an angle as well. That is also an angle. But it is neither acute nor right. It is obtuse. Thus that angle is an obtuse angle.

- 1.What is that?
- 2.Is it a right angle?
- 3.It is an obtuse angle, isn't it?

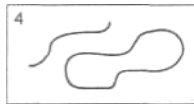

All these are curves.  
These are simple curves.  
They are simple open and closed curves.  
In other words, these curves are simple open and closed.

- 1.What are all these?
- 2.Are they simple curves?
- 3.These curves are simple open and closed, aren't they?

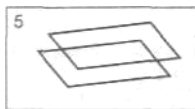

Those are planes.  
Those are parallel planes.  
They are parallel.  
So those planes are parallel.

- 1.What are these?
- 2.Are they parallel planes?
- 3.Those planes are parallel, aren't they?

II. Complete the dialogues. Use the information from the pictures.

1.



Number 1 is ...  
What ...this?  
... a pipe.  
Is...long?  
Yes, it ..is ....

This is a pipe. It is long.

2.



... is a tyre.  
What is that? ... a tyre?  
..., it is.  
Is ... wide?  
No,it... . It is....

That is a tyre. It is narrow.

3.

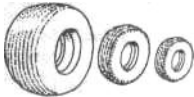

What... ?  
... wheels.  
Are... small?  
..., they are not.  
... are big.

These are wheels. They are big.

4.



What...?  
... containers.  
Are ...full?  
..., they ... .  
... they empty?  
..., they are not.  
They are full, aren't they?  
..., they are. They are ... .

Those are containers. They are full.

### Activity

I. Check if your groupmate knows the English names of these tools. Begin like this.

- What is this?
- This is a chisel.
- Is it a new chisel?
- No, it isn't. It is a very old tool.
- ...



## II. Translate the Russian phrases into English and reproduce the dialogue with your partner.

-Hi. What are you busy with?

-Я занят геометрией. Может, поможешь?

-Yes, of course. That's easy. Look. Basic geometrical elements are точка, прямая, плоскость.

-Are the lines all the same?

-Конечно нет. Они бывают прямые и кривые. А кривые бывают замкнутые и незамкнутые.

-And what are these?

-Это углы. Это острый, это прямой, а это тупой угол.

-What are those, I wonder?

-А это плоскости. Они параллельны.

-And one more question. What are basic geometrical shapes?

-Круг и квадрат.

-I see it now. Thanks a lot.

-Пожалуйста.

## Writing

I. Describe some geometrical shapes and use the following adjectives.  
right, obtuse, acute, open, closed, parallel

II. Translate the following text into Russian. Make sure you know the international words before you start.

Many areas of science are "ologys". Some of them are *familiar*<sup>1</sup> to you, for example, biology. Some of them are not. Let me tell you about several subjects and professions.

Molecular biology is interested in *cells*<sup>2</sup> and genes. Molecular biologists are good at analysing DNA or fingerprints.

*Mineralogists*<sup>3</sup> are busy with studying minerals in soils and rocks.

*Enzyme technologists*<sup>4</sup> are interested in synthesizing new organic molecules or modifying existing molecules *to make*<sup>5</sup> useful medicines and pharmaceuticals.

*Geomorphology*<sup>6</sup> is busy with protecting water and important river ecosystems.

And *immunologists*<sup>7</sup> are interested in studying different transplants, allergies, HIV and development of vaccines.

<sup>1</sup>известны, <sup>2</sup>клетки, <sup>3</sup>минерологи, <sup>4</sup>ферментологи,  
<sup>5</sup>чтобы создать, <sup>6</sup>геоморфология, <sup>7</sup>иммунологи.

# THE BASICS OF GEOMETRY

## Section A. Shapes and Forms

### Lead-in

- I. List different geometrical shapes. Compare your list with that of your groupmate.
- II. The students are at the lesson of Geometry now. Listen to their conversation and learn how to name different geometrical shapes.

#### A

*Ivan:* What's this?

*Olga:* It's a ruler.

*Ivan:* What shape is it?

*Olga:* It's rectangular. It has two equal sides.

*Ivan:* Is the ruler wide?

*Olga:* No, it isn't. It's rather narrow.



#### B

*Alice:* Look at this object. What shape is it?

*Paul:* I think it's square. It has four right angles and four equal sides.

*Alice:* No, you are wrong. It's rectangular. Only two parallel sides are equal.

*Paul:* And the angles are right, aren't they?

*Alice:* Certainly.

III. Complete the following dialogues.

1. -What is this?

-....

-What, ...?

-It's a square.

2. - What shape is the object?  
 — ... . It has no angles.
3. - Look at this object....  
 —If I'm not mistaken it's ...  
 —Yes, you are quite right.

### Language Practice

I. Match the picture with the noun and with the adjective and make a sentence with them.

EXAMPLE: a) This is a ruler. The ruler is rectangular.

a)



b)



c)

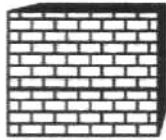

d)



e)

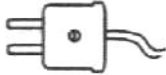

f)



g)



a wheel

a plug

a ruler

a socket

a wall

a door

a triangle

circular

rectangular

round

triangular

square



II. Ask your groupmate about the objects in the picture below.

EXAMPLE: A: What is it? A: What are these?

B: This is a small square. B: These are large squares.

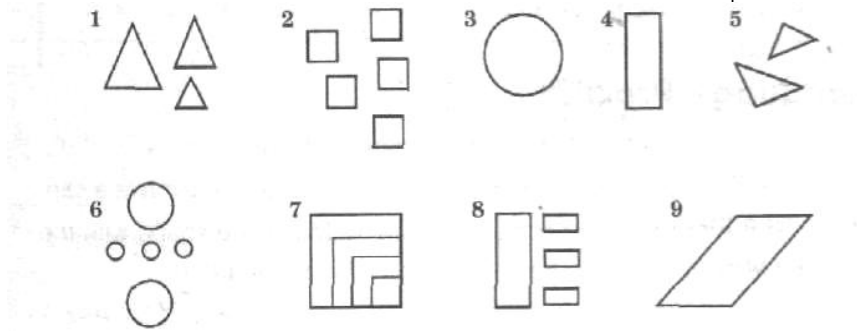

III. Study the table and give answers to the questions in two possible ways.

Figures	a square, a triangle, a rectangle, a circle
Shapes	square, triangular, rectangular, circular

EXAMPLE: A: What shape is the window?

B: It's rectangular. or It's a rectangle.

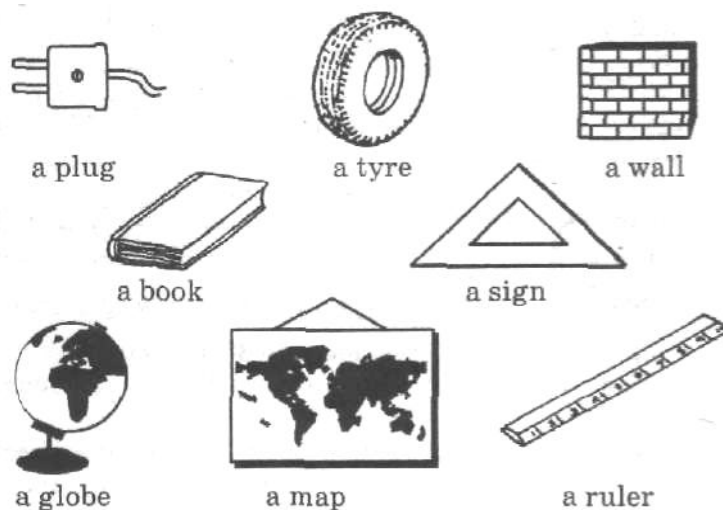

**IV. Fill in the gaps. Use to *have* in the right form.**

1. This square ... four right angles.
2. The circle ... any angles.
3. ... you ... a spare tyre?
4. ... he ... a lot of free time?
5. My brother ... many tools.
6. I .....goggles. Please, give me yours.
7. These objects ... the shape of a cylinder,
8. This plug in the socket... a cover.  
they?

**V. These are some more geometrical shapes. Match the shape with the correct name.**



- a) square   b)   c)   d)   e)   f)   g)  
                  octagon   heptagon   hexagon   rectangle   decagon   pentagon

**VI. That's how we express agreement and disagreement in English. Study this table.**

HOW TO EXPRESS AGREEMENT AND DISAGREEMENT:	
Yes, it is/does.	No, it isn't/doesn't.
Certainly.	Certainly not.
I quite agree with you.	No, you are wrong.
You are quite right.	You are mistaken, I'm afraid.
I think so.	Far from it.
I can't but agree with you.	I disagree.
Absolutely right.	I can't agree with you.
I agree only to some extent.	I'm of the opposite opinion.

**VII. Say whether you agree or disagree with the following descriptions.**

1. This is a triangle. It has three sides and 3 right angles.
2. This is a square. It has four equal parallel sides and four right angles.
3. This is a pentagon. It has no parallel sides, all the angles are acute.
4. This is a hexagon. It has three pairs of parallel sides, one of the angles is obtuse.

5. The sum of the angles of a triangle is  $90^\circ$ .

6. An obtuse triangle has two obtuse angles.

VIII. Translate the following sentences from Russian into English.

1. Какую форму имеет этот блок? - Он квадратный.

2. У квадратов четыре равные стороны и четыре прямых угла.

3. Круги не имеют углов и сторон.

4. Эти предметы имеют разные формы: квадратные, прямоугольные, треугольные, круглые.

5. Эта стена квадратная, не так ли? - Да. Она квадратная.

6. Этот треугольный предмет имеет равные углы. - Нет, не совсем.

7. Эта дверь прямоугольная или квадратная? - Она прямоугольная.

### Reading and Speaking

I. Read the text and learn how to describe geometrical figures and objects.

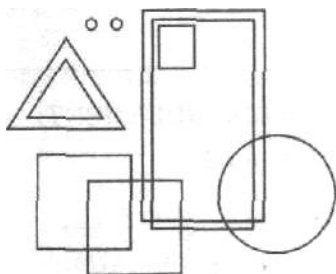

A. Look at the picture. These are different shapes. They are triangles, squares, rectangles and circles. Triangles have three sides and three angles. Squares and rectangles have four sides. Squares have four equal sides, but rectangles have two equal sides. Circles do not have angles or sides.

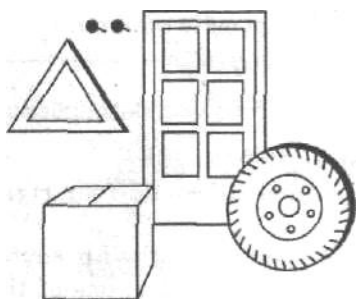

B. Look at the picture. These are different objects. This is a box, a wheel, a frame, a door and a pair of nails. They have different shapes. The box is square. The door is not square, it is rectangular. The nails are circular. The wheel is circular too. The frame is triangular.

II. Answer the following questions.

A

1. What shapes are these?
2. Do triangles have three sides?
3. Do they have three angles?
4. Do squares have four or two equal sides?
5. Do rectangles have four equal sides?
6. Circles do not have angles or sides, do they?

B

1. Do these objects have different shapes?
2. What shape is the box?
3. Is the door square or rectangular?
4. Are the nails circular?
5. The wheel is circular, isn't it?
6. What shape is the frame?

III. Complete the dialogues.

A

*Paul:* What are those?

*Ann:* ... shapes.

*Paul:* What... they?

*Ann:* They are triangles, and ....

*Paul:* Squares have ... sides and ... angles.

*Ann:* Triangles ... three ... and ... angles.

*Paul:* Yes..

*Ann:* Rectangles have ... sides and four ....

*Paul:* Circles do not have ... or ... .

**B**

*Alex:* What's this?

*Peter:* ... a box.

*Alex:* What's the shape of the box? Is it circular?

*Peter:* No, ... is .... It is ....

*Alex:* What's that?

*Peter:* ... a wheel.

*Alex:* The wheel is .... isn't it?

*Peter:* Certainly.

## Activity

I. Draw different shapes and ask your groupmate to name and describe them.

II. Use the expressions of agreement and disagreement and describe these objects in pairs.

Begin like this: - This is a triangle, isn't it?

- Absolutely right.

- It has three angles and two sides.

- No, you are wrong. It has three angles and three sides.

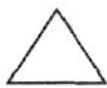

a triangle



a rectangle



a square



a circle

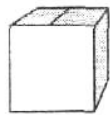

a box



a wheel



a screen

## Writing

I. Link the sentences using appropriate linking words such as *and*, *but*

1. a) Squares have four sides.

b) Rectangles have four sides.

2. a) Squares have four equal sides,

b) Rectangles have two equal sides.

3. a) Triangles have three angles,

b) Rectangles have four angles.

II. Describe shapes of different objects in your classroom.

## Section B. Measurements

### Lead-in

#### I. Discuss the following questions:

- Is an engineering project possible without knowledge of measurements?
- Are you familiar with any units of measurement? If so, name them.

#### II. Learn how to speak about dimensions of different objects and shapes.

A

- How wide is the box?
- It's 2 centimeters wide.
- How long is it?
- It's 3 centimeters long.
- By the way, how high is it?
- It's 2 centimeters high.
- And what is the volume of this box?
- It's  $12 \text{ cm}^3$  (cubic centimeters).

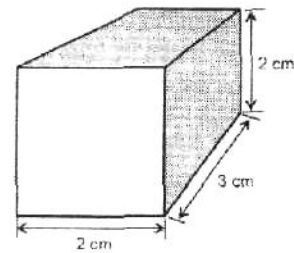

B

- What's the width of the room?
- The width is 3 metres.
- And what's the length of the room?
- The length is 7 metres.
- So, what is the square of the room?
- Well, it is  $21 \text{ m}^2$  (square metres).

#### III. Complete the dialogues.

- How ... is the book?  
- It's ... wide.
- What's the ... of the block?  
-The length is ...
- How long is the ruler?  
-....

Language Practice

I. Complete this following the example.

EXAMPLE: length - long  
width. - \_\_\_\_\_  
height - \_\_\_\_\_  
depth - \_\_\_\_\_  
thickness - \_\_\_\_\_

II. Use the proper word in the following situations.

1. The distance is very long/length. The long/length of the route is 2 km.
2. The wide/width of the river is 57 m. It's not very wide /width.
3. - What's the high/height of the building?  
- The building is rather high/height. It's about 60 m.
4. - Is this lake deep/depth?  
- No, it isn't. The deep/depth of this lake is only 6 m.
5. It's a very thick/thickness wall. Its thick/thickness is 46 cm.

III. Study this table.

<i>Write it like this:</i>	<i>Say it like this:</i>
4,653	four thousand, six hundred and fifty-three
5.653	five point six five three
1.01	one point oh one <i>or</i> one point zero one
0.57	point five seven

IV. Write down and read the following numbers.

17.04	2402.7
5,015	340.18
3.14	72,023
19,316	7.2023
95,012	0.72023
60.015	0.072023

V. Play Bingo.

Look at the numbers given below. Write down any five of the numbers. Listen to the teacher calling out the numbers at random. If you hear

**one of your numbers, cross it out. The first student to cross out all five of**

his numbers calls out "Bingo" and reads out the numbers to prove his claim.

7; 13; 2.5; 100; 99; 1000; 107; 5.5; 5; 88; 87; 12; 41; 55; 0.5; 1,356; 1,007; 112; 1021; 48; 84; 119; 9.9; 73; 8.8; 1,119; 18.18; , 1.356; 3.14

## VI. Complete according to the table.

	long - longer - (the) longest	
short	- ...	- (the) shortest
thick	- thicker	- ...
thin	- ...	- (the) thinnest
narrow	- ...	- (the) narrowest
wide	- ...	- ...
Large	- ...	- ...
small	- ...	- ...
high	- ...	- ...
Low		

## VII. Compare the objects.

EXAMPLE: *The nail is 6 cm long but the screw is only 3 cm long.*

The nail is longer than the screw.

or The screw is shorter than the nail.

1. The wall is 6 m long but the wire is only 4 m long.
2. The frame is 2 m high but the glass is only 1 m high.
3. The car is 2 m wide but the truck is 4 m wide.
4. The lorry is 4 m high but the bridge is only 3 m high.
5. The instrument is 30 cm long but the box is only 20 cm long.

## VIII. Correct mistakes.

1. The room is a rectangular.
  2. This lamp are circular.
  3. Triangles have four angles and four sides.
  4. -How width is the box?
  5. The wide of the box is 6cm.
  6. This block is 30 cm length, 10 cm wide and 3 cm high.
  7. It is the larger car in the garage.
  8. This road is long than that one.
  9. The area of this window is 2 cubic metres,
  10. The volume of that room is 24 square metres.
- IX. Translate the following sentences into English using your active vocabulary.



1. Какой высоты эта стена? - Ее высота - три метра.
2. Высота этого предмета пять сантиметров, длина — три сантиметра, ширина - один сантиметр, следовательно, его объем -  $15 \text{ см}^3$ .
3. Наша комната прямоугольная. Ее площадь составляет примерно  $25 \text{ м}^2$ .
4. В комнате одно окно высотой 2 метра и шириной один метр.
5. Какова длина классной комнаты? Между прочим, какова ее ширина?
6. На самом деле площадь классной комнаты составляет  $30 \text{ м}^2$ .
7. Этот предмет - большой, а тот - еще больше. К тому же, третий предмет - самый большой.
8. Длина этого блока 20 см, ширина - 5 см и высота — 10 см.

### Reading and Speaking

I. Look at the pictures below and answer these questions.

A

1. Is the room rectangular?
2. How high is the room?
3. How long is it?
4. What's the volume of the room?

B

1. How high is block B?
2. How wide is block B?
3. What's the length of block C?
4. Is block **B** larger than block A?
5. Which is the largest block?

II. Read the text and check your answers.

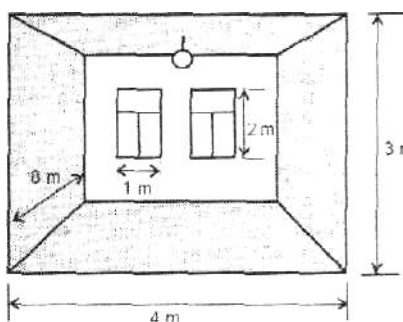

A. This is a room. It's rectangular. The height of the room is 3 m. The room is about 4 m wide. It has a length of 8 m. So, the volume of the room is approximately  $96 \text{ м}^3$ . The room is light. It has two wide windows. The length of the window is 2 m and the width is 1 m. Thus, the area of the window is  $2 \text{ м}^2$ .

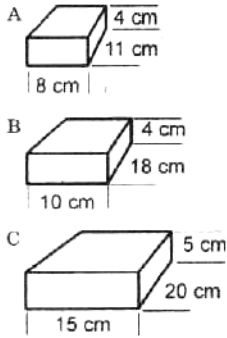

**B.** These are blocks **A**, **B** and **C**. Block **A** is 4 cm high, 8 cm wide and 11 cm long. Block **B** has a height of 4 cm, a width of 10 cm and a length of 18 cm. Block **C** has the following dimensions: it is 5 cm high, 15 cm wide and 20 cm long. So, the volumes of the blocks are different. Block **B** is larger than block **A**, but block **C** is the largest.

### III. Complete the dialogues.

**A**

A: What's this?

B: ... room.

A: ... it square?

B: No, ... rectangular.

A: How wide is ... ?

B: It's 3m... .

A: What... the length of the room?

B: It... 6 m ....

A: How ... is the room?

B: It... 2 m high.

A: So, the volume of the room ... approximately ....

**B**

A: What ... these?

B: ... blocks **A**, **B** and **C**.

A: Block **A** has a ... of 5 cm, a ... of 6cm, and a ... of 7 cm.

B: How... is block **B**?

A: ... 5 cm high.

B: How....block **C**?

A: The width... 15 cm.

B: You see, the ... of these blocks ... different.

A: I quite agree.

### IV. Describe the dimensions of your classroom and some objects in it.

## Activity

I. Describe the dimensions of the objects.

EXAMPLE: A: How wide is the wall?

B: It's 60 centimetres wide.

A: How long is it?

B: It's 10 metres long.

A: How high is the wall?

B: It's 3 metres high.

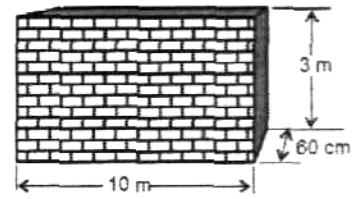

a road

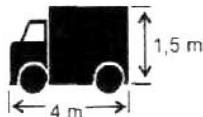

a car

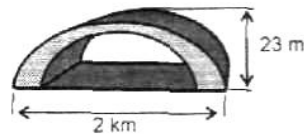

a bridge

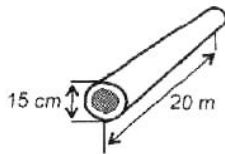

a tube

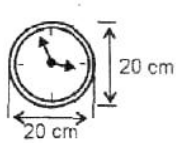

a clock

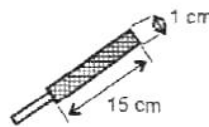

a file

II. Describe the dimensions of an object from the box below. Do not mention the object. Let your groupmates guess what it is.

EXAMPLE: The length of the object is about 12 m.

The width is about 7 m.

The height is about 5 m.

So the volume of the object is about  $420 \text{ m}^3$ .

What is it? (It is a classroom.)

a) a desk top

(surface)

b) a blackboard

c) a window

d) a door

e) a drawer (in a table)

f) an eraser

## Writing

**I. Choose an object in your classroom and write its description using the following words:**

area, height, length, width, approximately, volume, etc.

**II. Translate the following text into Russian paying attention to British units of length.**

The test section is a metal cylinder 2 ft 6 in long, 6 in id and 6.25 *in od*. Both ends of the cylinder have glass plates 1/4 in thick. An admission port<sup>1</sup> 2.7 in diameter is at each end of the cylinder.

1 in = 1 inch = 2.54 cm

1 ft = 1 foot = 12 inches = 0.3048 m

id = inner diameter - **внутренний диаметр**

od = outer diameter - **внешний диаметр**

---

<sup>1</sup>впускное отверстие

## UNIT THREE

### THE WORKSHOP

#### Section A. Took and Instruments

Lead-in

I. List as many tools as you know. Compare your list with that of your partner.

II. Students of the Technical University practise their skills in the workshop. Listen to their conversations and learn how to speak about the location of different tools in the workshop.

A

*Paul:* This is a workshop, isn't it?

*Olga:* I think it is.

*Paul:* And where is the workbench?

*Olga:* Well, it's in the middle of the room.

*Paul:* Where's the toolbox? Is it on the bench?

*Olga:* No, it isn't. It's under the bench.

*Paul:* And where are the nails? Are they on the bench or in the box?

*Olga:* They are in the box.

*Paul:* I see. And where's the hammer?

*Olga:* It seems to me, it's on the shelf above the table.

*Paul:* Well, give me the hammer, please.

*Olga:* Here you are.

*Paul:* Thanks.



**B**

*Mike:* Look here. What are these?

*Andrew:* These are screws.

*Mike:* And where are the nuts? Are they on the workbench?

*Andrew:* Yes, they are. Oh, no, I'm sorry. They are on the shelf under the bench.

*Mike:* Are they big or small?

*Andrew:* They are rather small.

*Mike:* How long are they?

*Andrew:* I think they are approximately 20 mm long.

*Mike:* How wide are they?

*Andrew:* I believe they are 4 mm wide.

*Mike:* O.K. Give me some, please.

*Andrew:* Here you are.

*Mike:* Thank you.



III. This is how we express our opinion in English. Study this table.

HOW TO EXPRESS OPINION:	
I think (that)...	I consider (that) ...
I believe (that) ...	In my opinion ...
From my point of view ...	To my mind ...
As I see it...	It seems to me ...
As for me ...	I guess ...

IV. Complete the dialogues using different ways of expressing opinions.

1. - Where is the spanner?

- ... .

-And where is the toolbox then?

- ... .

2. - ...

- This is my brand-new chisel.

- And where is your old chisel?

- ... .

- Is your new chisel bigger than the old one?

- ... .

## Language Practice

I. Study the following word-building rule and translate the sentences below.

---

a drill - сверло (*существительное*)

to drill - сверлить (*глагол*)

---

1. There is a drill on the workbench.
2. Drill a hole in the piece.
3. Put the drill over the mark.
4. Mark the hole.
5. Saw this piece of wood into two parts.
6. There is no saw in the toolbox.

II. Ask where you can find the following things in the workshop.

EXAMPLE 1: *a hammer*  $\left\{ \begin{array}{l} \textit{on the shelf} \\ \textit{on the workbench} \end{array} \right.$

A: -Where is the hammer? Is it on the shelf?

B: - Yes, it is. It is on the shelf.

or - No, it is not. It is on the workbench.

a drill  $\left\{ \begin{array}{l} \textit{in the box} \\ \textit{under the table} \end{array} \right.$

a spanner  $\left\{ \begin{array}{l} \textit{on the floor} \\ \textit{in the toolbox} \end{array} \right.$

a screwdriver  $\left\{ \begin{array}{l} \textit{on the shelf} \\ \textit{on the toolboard} \end{array} \right.$

a file  $\left\{ \begin{array}{l} \textit{on the bench} \\ \textit{in the drawer} \end{array} \right.$

EXAMPLE 2: *nails*  $\left\{ \begin{array}{l} \textit{on the table} \\ \textit{in the box} \end{array} \right.$







A: - Where are the nails? Are they on the table?

B: - Yes, they are. They are on the table.

or - No, they are not. They are in the box.

- nuts <ul style="list-style-type: none;">  - among screws
  - in the packet
- screws <ul style="list-style-type: none;">- in the box
- in the drawer
- tools <ul style="list-style-type: none;">- between the table and the bench
- under the shelves
- switches <ul style="list-style-type: none;">- to the left of the window
- to the right of the door

III. Match the sentences with the pictures.

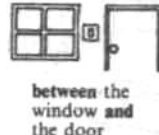
The screwdriver is . . . .	The switch is . . . .
(a)  on the table	(d)  above the window
(b)  under the table	(f)  beside the window
(c)  in the box	(e)  below the window
	(g)  between the window and the door

1. The switch is below the window.
2. The screwdriver is in the box.
3. The switch is above the window.
4. The switch is between the window and the door.
5. The screwdriver is on the table.
6. The screwdriver is under the table.
7. The switch is beside the window.

IV. Are these sentences true or false? Correct the false ones.

EXAMPLE: (a) *The screwdriver is under the shelf.* FALSE. The screwdriver is on the shelf.

a)  The screwdriver is under the shelf.





The door is between the socket and the table.

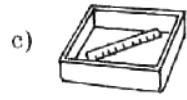

The ruler is in the drawer.

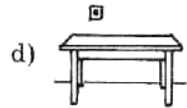

The switch is below the table.

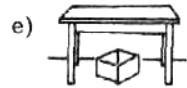

The box is on the table.

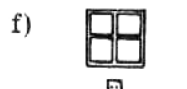

The socket is above the window.



The screw is under the box.



The socket is on the table.



The saw is on the shelf.

V. a) Put the following pictures in the correct order.

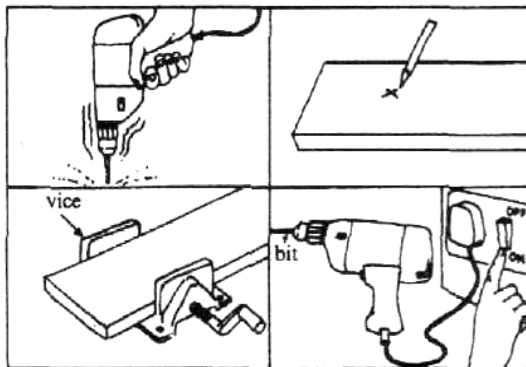

**b) Arrange the following instructions to fill in the gaps.**

- |                        |                                 |
|------------------------|---------------------------------|
| First, you ...         | a) Switch on the drill.         |
| Then you ...           | b) Place the wood in a vice.    |
| Next, ... but don't... | c) Place the bit over the mark. |
| Now, you ... and ...   | d) Tighten the vice.            |
| Finally, ... and ...   | e) Take the electric drill.     |
|                        | f) Drill the hole.              |
|                        | g) Mark the hole.               |
|                        | h) Do not over tighten.         |

**VI. Match the words from the three columns.**

*Student A:* Ask your friend how to do the following jobs.

*Student B:* Give your friend instructions.

EXAMPLE: a-5-c

- How to remove this nail from the tyre?  
- Pull it firmly with a pair of pliers.

<i>Job</i>	<i>Method</i>
a)remove /nail / tyre	1) twist / tightly
b)make / hole / steel pipe	2) press / gently
c)join / cables	3) drill / carefully
d)check / concrete / dry	4) measure / carefully
e)check / width / shelf	5) pull / firmly
f)paint / wall	6) spread / evenly

<i>Tool</i>
a)electric drill
b)finger
c)pair of pliers
d)brush
e) ruler

**VII. Translate the following sentences from Russian into English.**

1.— Это мастерская? - Да.

2.- Где находится верстак? - По-моему, он стоит в центре мастерской.

3.- Где коробка с инструментами? Она на полке? - Нет, мне кажется, она под полкой.

4.- Плоскогубцы находятся в коробке, не так ли? - Нет, я думаю, что плоскогубцы и молоток на полке за столом.

5.- Дай мне, пожалуйста, гвозди и шурупы. - Держи.

6. Инструкция по технике безопасности висит над рабочим столом.

7. Коробка с инструментами стоит справа, а коробочка с шурупами и гайками находится слева.

### Reading and Speaking

I. Look at the picture and say what it is. Read the text to see if you are right.



This is a workshop. Two students are here. They are Sveta and Oleg. They are electricians. A toolboard is in the middle of the workshop. Many tools are on the toolboard. They are chisels, screwdrivers, a pair of pliers, a set of spanners, etc.

A safety-notice is above the tool-board. A bench is on the left and a shelf is on the right. There are many nails, nuts and screws on the shelf. They are small. A hammer is not on the shelf, it is on the bench. A switch is between the bench and the shelf. Sveta is to the right of the bench. Oleg is on the other side of the workshop just opposite the toolboard.

II. Answer the questions given below.

1. This is a workshop, isn't it?
2. What are the names of the students?
3. What are Oleg and Sveta?
4. Where is the toolboard?
5. Where are the tools?
6. What are they?
7. Is the bench on the right or on the left?
8. The hammer is not on the shelf, is it?
9. Where are the students?

III. Fill in the gaps and reproduce the text.

This is a ... . A toolboard is in the ... the workshop. Many ... are ... on the toolboard. They are chisels, ..., a pair of ... , a ... of spanners. A safety-notice is ... above the toolboard. A bench is ... on the left and a shelf is ... on the right. There are many nuts, screws, ... on the shelf. They ... small and

small. A hammer... on the shelf, it is ... the      A switch is ... the bench  
and the shelf. Oleg is ... the toolboard. Sveta ... to the ... of the bench.

## Activity

I. Ask your partner about the location of the objects below. Use different ways of expressing your opinion.

EXAMPLE: *the nails / in the packet / in the box*

- The nails are in the packet, aren't they?

- No, I think they are in the box.

the instruments / on the table / in the toolbox

a pair of pliers / on the toolboard / on the shelf

a set of chisels / to the right of the files / to the left of the files

the switches / above the bench / under the bench

the nuts / among the nails / among the screws

II. You are in the workshop. Ask your friend to bring the tools you need. You may start like this.

A: Give me some nails, please.

B: What nails? Big or small?

A: The biggest ones.

B: Where are they?

A\* Well, I think they are in the box.

B: No, they are in the drawer. Here you are.

A: Thanks. Now give me, please, ...

B: ...

## Writing

I. Write a safety-notice for a workshop. Use the words below.

Always	hold	Machines with a brush - never with
Never	wear	your hands.
	clean	A workpiece in a vice.
	use	Metal ladders near electrical
	keep	wires.
	...	Goggles when you grind
		something.
		Workshop floors clean and
		free from oil.
		Damaged switches.
		...

II. Link two instructions into one.

EXAMPLE: *First switch off the mains. Then touch that wire.*

Switch off the mains before you touch that wire.

- a) First switch off the mains. Then touch that wire.
- b) First sharpen the chisel. Then use it.
- c) First get into the car. Then drive it.
- d) First mark the wood. Then saw it.
- e) First remove the plug from the socket. Then cut the wire.
- f) First put your goggles on. Then hammer the stone.
- g) First put the guard down. Then grind the chisel.

*Section B. Motor Vehicles*

Lead-in

I. Are you good at driving? Name as many differences as you know between a car and a motorcycle. Compare your list with that of your groupmates.

II. Different vehicles have different types of engines. Listen to the students' conversation and learn the difference between a car engine and a motorcycle engine.

*Tanya:* Look at the picture. What's there in the first picture?



*Alex:* There is a motorcycle.

*Tanya:* And there's a car in the second picture, isn't there? *Alex:* Certainly.

*Tanya:* As far as I know both vehicles have engines. Is there any difference between the types of engines?



*Alex:* Well, let me think. If I'm not mistaken, a motorcycle has an air-cooled engine and there's a water-cooled engine in a car.

*Tanya:* Are there any other differences?

*Alex:* Yes, of course. A water-cooled engine always has a radiator. But there's no radiator in the motorcycle.

*Tanya:* You mean an air-cooled engine never has a radiator.

*Alex:* You are absolutely right.

**III. That's how we express certainty and uncertainty in English. Study this table.**

HOW TO EXPRESS CERTAINTY	AND UNCERTAINTY:
Yes, certainly.	I'm not sure...
Definitely.	As far as I know...
I'm sure.	If I'm not mistaken...
There is no doubt about it.	If I remember right...
I think so.	I don't think so...

**IV. Complete the dialogue and use the expressions of certainty and uncertainty.**

- Look, can you help me?
- ...
- I don't know the difference between the engines in a car and in a motorcycle. Can you tell me?
- .... The motorcycle ... engine, and the car ..., if I'm not....
- Do water-cooled engines always have a radiator?
- ...
- And what about air-cooled engines?
- ...
- ...

**Language Practice**

**I. Cross out the odd word.**

1. fuel, diesel, petrol, gas
2. valve, vehicle, spark plug, engine
3. car, motorcycle, vehicle, radiator
4. headlights, wipers, windscreen, injector
5. saw, tool, hammer, drill
6. on, in, but, between

**II. Match the words from two columns to make up word combinations.**

- spark
- fuel
- air-cooled
- spare
- oil
- steering

wheel            plug  
 injector        parts  
 engine         sump

III. These two sentences have a different structure but the same meaning. Change the structure of the sentences below so as to keep their meaning unchanged.

EXAMPLE: *The car has a radiator.*

There is a radiator in the car.

1. The motorcycle has an air-cooled engine.

There ...

2. The 2-stroke diesel engine has a fuel injector.

There ...

3. The diesel engine has an oil sump.

There...

4. The motorcycle engine has a fan.

There ...

5. A car has a steering wheel.

There ...

IV. Describe these pictures.

EXAMPLE: (a) There are nails on the road.

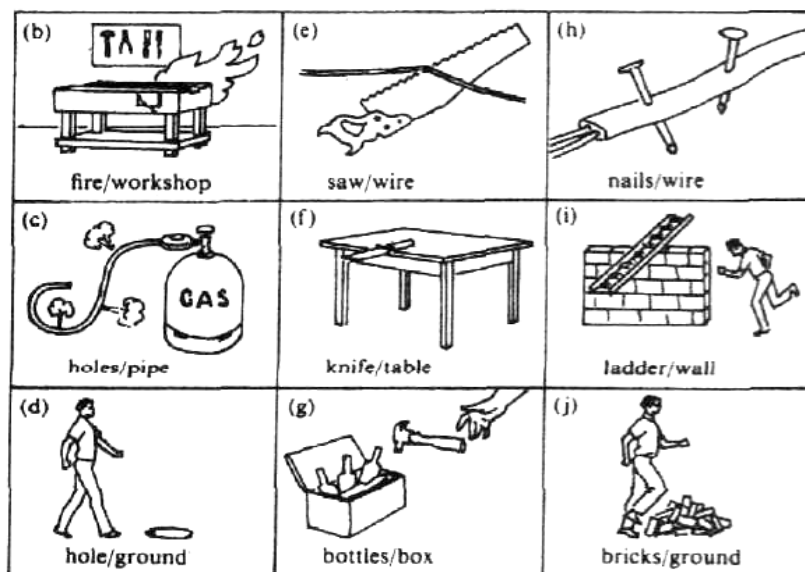
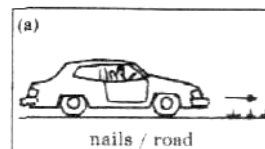

**V. Ask your friend where the following things are. Make questions with *Is there...?* and *Are there ... ?* and your partner will answer using different expressions of certainty and uncertainty.**

EXAMPLE 1: *radiator / in the car*

- Is there a radiator in the car?
- Yes, certainly. There is a radiator in the car.

fan / at the front of the car engine

an engine / at the back of the car a spare wheel / in the garage a jack / under the car

EXAMPLE 2: *valves / in the engine*

- Are there any valves in the engine?
- Yes, there are. As far as I know, there are some valves in the engine.

spark plugs / in the engine tools / in the toolbox

headlights / on the front spare tyres / in the boot

**VI. Study this example. Pay attention to the translation of *the one*. Complete the sentences below and translate them into Russian.**

EXAMPLE: There are two files in the toolbox. One has a handle and the other has no handle. Give me ... - Give me the one without a handle.

1. There are two hammers on the workbench. One has a long handle and the other has a short one. Please give me ... .
2. There are two boxes under the table. One has a lid and the other has no lid. Could you bring me ....
3. There are two pairs of scissors on the shelf. One has short blades and the other has long blades. I need ....
4. There are two pairs of pliers on the toolboard. One has plastic handles and the other has rubber handles. Please bring me ....

**VII. Find mistakes in the following sentences and correct them.**

1. The nuts is on the workbench.
2. - Where are the nails? Are they on the table? - Yes, it is.
3. Switch off the drill and then drill the hole.
4. Is there many differences between the types of engines?
5. Water-cooled engines always has a radiator.
6. There are water-cool and air-cool engines.
7. You should hold a workpiece between the vice.
8. You have two spare tyres. Bring me the one tyre from the boot.



### VIII. Translate the following sentences from Russian into English.

1. Транспортные средства имеют различные типы двигателей.
2. В мотоциклах стоит двигатель с воздушным охлаждением, а в автомобиле - с водяным.
3. У двигателей с водяным охлаждением всегда есть радиатор.
4. Насколько я знаю, существует два типа двигателей: дизельный и бензиновый.
5. В бензиновых двигателях есть свечи зажигания, а в дизельных двигателях их нет.
6. Без сомнения, существуют различия между двух- и четырёхтактными двигателями.
7. Если я не ошибаюсь, в четырёхтактных двигателях всегда есть клапаны.
8. Запасные части находятся в гараже в ящике для инструментов.
9. В этом горючем нет масла.
10. Я считаю, что дизельные двигатели имеют форсунки.

### Reading and Speaking

I. There is no motor vehicle without an engine. And today we have different types of engines. Read the text to learn more about them.

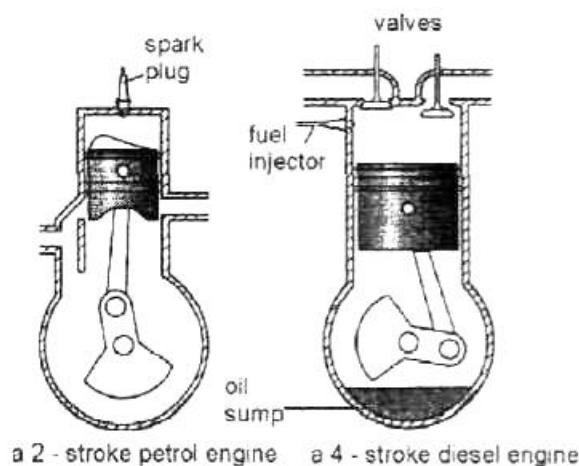

All motor vehicles have an engine. There are two types of engines. There are petrol engines and there are diesel engines. There are two engines in the diagram.

There is a two-stroke petrol engine on the left. There is a four-stroke diesel engine on the right. There are spark plugs in all petrol engines. Diesel engines do not have spark plugs. They have fuel injectors.

There are always valves in 4-stroke diesel engines. There are no valves in 2-stroke petrol engines. A 2-stroke petrol engine never has valves.

There is no oil sump in a 2-stroke engine. There is oil in the fuel. The 4-stroke engines have an oil sump. There is no oil in the fuel.

## II. Answer the questions.

1. Is there an engine in all motor vehicles?
2. What are the types of engines?
3. Which engines are there in the diagram?
4. Are there any spark plugs or fuel injectors in diesel engines?
5. There are always valves in 4-stroke engines, aren't there?
6. Which engines have oil sumps?

## III. Complete this table according to the information in the text.

<i>Type of engine</i>	Oil sump	Valves	Fuel injector	Spark plug
2-stroke petrol engine				
4-stroke diesel engine				

## IV. Define whether the sentences are true or false. Correct the false ones.

1. Modern vehicles have no engine.
2. All petrol engines have spark plugs.
3. A 2-stroke petrol engine has valves.
4. A motorcycle has a steering wheel.
5. A car usually has side lights.
6. There are handlebars in all vehicles.

## V. Discuss with your friend the differences between a motorcycle and a car.

### Activity

#### I. You want to get a driving licence. Continue the conversation with your examiner.

EXAMPLE: A: Are there side lights in the car?

B: Yes, there are.

A: Where are they exactly?

B: They are at the front of the car.

A: ...

II. Describe a car you'd like to have in the future. Use the following key words.  
 vehicle, engine, difference, fuel, fan, headlights, steering wheel, wipers, etc.

Writing

I. Study the picture and complete the description accordingly.

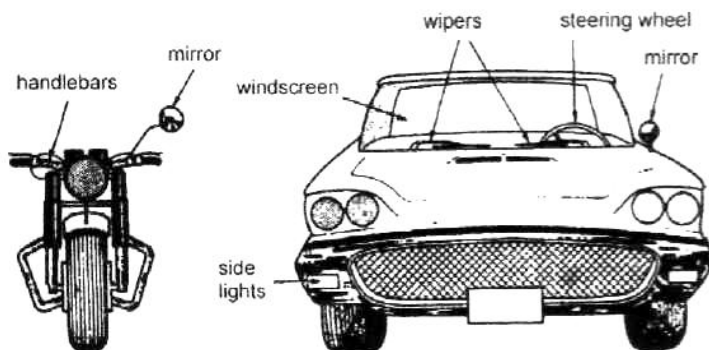

In the diagram there is a motorcycle on the ... and there is a ... on the right .... a headlight on the front of the motorcycle. The car ... two headlights at each side. There ... two wipers on the windscreen. ....no windscreen on the ... and it has ... wipers two side lights on the front of the ....no side lights on the front of the .....a steering wheel in the car. A motorcycle ... no steering wheel .....handlebars. ... is a mirror on the car and there ... a mirror on the motorcycle.

II. a) Match the English compound nouns with their Russian equivalents.

vehicle engine	<b>двигатель с боковым расположением клапанов</b>
side valve	<b>двигатель с верхним расположением клапанов</b>
engine	
overhead valve	<b>степень сжатия</b>
engine	
compression ratio	<b>двигатель транспортного средства</b>

b) Translate the following passage paying attention to the translation of the compound nouns.

Almost all modern vehicle engines have valves. There are side valve engines. In this design the valves are at the side of the cylinder. It is a comparatively simple design. The side valve engines are not very powerful but quite reliable.

There are also overhead valve engines for vehicles. In this design the valves are overhead the engine and have a complex design. The overhead valve engines are powerful and have high compression ratio.

## Unit Four

### THE ENGINE

#### *Section A. Types of Engines*

#### LEAD-IN

#### **I. Discuss the following questions:**

- a) How are various types of vehicles different from each other?
- b) Are there different types of engines in different vehicles?

#### **II. Andrew is talking to his friend Paul about different vehicle engines. Listen to their dialogue and learn the names of these engines.**

*Andrew:* Hi, Paul. How are you?

*Paul:* Excellent, thanks. And you?

*Andrew:* So-so. You know I've got a problem.

*Paul:* What is it?

*Andrew:* I have a test on car devices tomorrow. Do you happen to know what types of engines there are in motor vehicles?

*Paul:* Well, let me think. A lot of motor vehicles have petrol engines. There are some motor vehicles with diesel engines.

*Andrew:* Are there any motor vehicles with gas engines?

*Paul:* I'm not sure but it seems to me that a few vehicles have gas engines.

*Andrew:* OK. And one more question to you. Are there any mixed fuel engines?

*Paul:* Well, I don't know exactly. I think only a few motor vehicles have such engines.

*Andrew:* Thank you so much for the information.

#### **III. That's how we usually ask and answer questions in English. Study this table.**

## QUESTION TECHNIQUE

Do you happen to know ...

I wonder if ...

Could you (possibly) tell me ...

I'd like to know ...

One more question (to you)...

## ANSWERING TECHNIQUE

Well...

Let me think ...

I don't know exactly ...

I'm not sure ...

It seems to me ...

As for me ...

### IV. Complete the dialogues. Use question and answering techniques.

- ... what types of engines there are in motor vehicles?
- .... There are ... with petrol engines . And some motor vehicles ..
- I wonder if there are ... with gas ....
- ... a few ... have gas engines.
- And there are some ..., aren't there?
- Thanks for the information.

### Language Practice

I. a) A 4-stroke engine naturally has four working cycles. Do you know all of them? Study this picture.

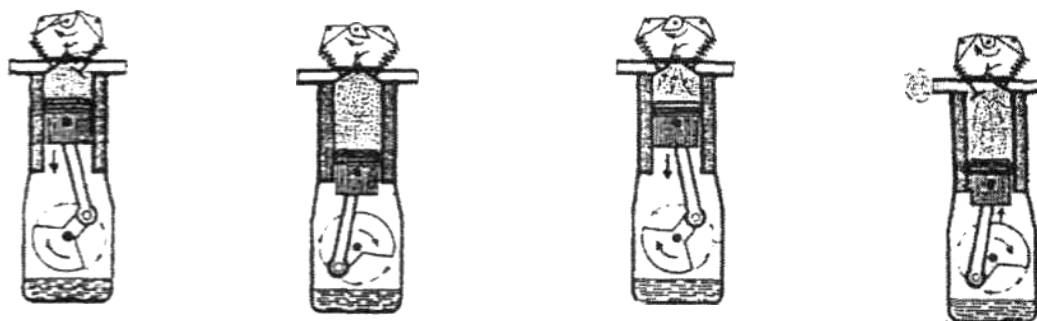

induction stroke    compression stroke    power stroke    exhaust stroke

b) Match the English word combinations with their Russian equivalents.

- |                   |                |
|-------------------|----------------|
| 1. power stroke   | a) ход выпуска |
| 2. exhaust stroke | b) ход сжатия  |

- 3.compression stroke      c) ход впуска  
 4.induction stroke      d) рабочий ход

**II. You want to know what objects your friend has in his garage. Ask him about their location using *some, any, not any*.**

EXAMPLE: *spare wheels / in the garage*

A:- Are there any spare wheels in the garage?

B:- There are some spare wheels there.

C:— There aren't any spare wheels there.

wipers / on the windscreen      tyres / in the garage  
 spark plugs / in the engine      cylinders / in the engine  
 tools / in the toolbox      nuts / on the worktable

**III. a) Match the pictures with the expressions of quantity and make sentences.**

EXAMPLE:      a) There are a lot of houses.



few  
 a few  
 many  
 a lot of



f) 

**b) Make up sentences using *a lot of, few, a few* and translate them into Russian.**

EXAMPLE: *cars / two-stroke engines*

- It seems to me there are a few cars with four-stroke engines.

lorries / four-stroke engines cars / an engine at the front  
motorcycles / two-stroke engines motorcycles / air-cooled engines  
lorries / six wheels vehicles / two-cylinder engines

**IV. Answer your partner's questions in two possible ways. Pay attention to the difference between *none* and *no*.**

EXAMPLE: *motorcycles / diesel engines*

A: How many motorcycles have diesel engines?

B: None have diesel engines.

or No motorcycles have diesel engines.

lorries / two-stroke petrol engines motorcycles / steering wheels motorcycles /  
water-cooled engines air-cooled engines / radiators engines / fans

**V. Fill in the blanks with *some, any, no, many, few, a few*.**

1. Are there ... car mechanics among your friends? - Yes, there are ... .

2. Are there ... students in the workshop? - No, there aren't....

3. There are ... nails on the bench but there aren't... screws.

4. I have too ... questions to ask about types of engines.

5. There are ... cars with two-stroke engines, aren't there?

6. How ... cars have diesel engines? ... cars have diesel engines.

7. There are ... nuts on the toolboard but there are ... bolts there.

**VI. Correct mistakes in the following sentences.**

1. There are not much vehicles with two-stroke engines.

2. This plant produces motorcycles. Only little motorcycles have four-stroke petrol engines.

3. - Are there some tools in that toolbox? - No, there are not any tools in it.

4. I'd like to know how many spark plugs are there in the engine.

5. There is not many cars with two-stroke engines, is there?

6. There are a lot of student in the workshop at the moment.

7. Are there some lorries with two-stroke engines?

8. I don't think there are some lorries with two-stroke engines.

9. I have few tools. Let's repair the car.

10. There are a few nails left. We need to buy some more.

**VII. Translate the following sentences into English.**

Многие автомобили имеют двигатели, работающие на бензине.

Ты случайно не знаешь, сколько свечей зажигания в этом двигателе?



3. Мне кажется, что только некоторые автомобили имеют газовые двигатели.

4.- Есть ли двигатели со смешанным видом топлива? - Я точно не знаю.

5. Немногие грузовики имеют четырехтактные двигатели.

6. Большинство двигателей находятся в передней части автомобиля.

7. Очень мало автомобилей имеют двигатели посередине.

8. Многие мотоциклы имеют двухтактные двигатели, не так ли?

## Reading and Speaking

I. Try to answer these questions before you read the text.

1. Are there any basic types of fuel for motor vehicles? What are they?

2. How many motorcycles have four-stroke petrol engines/two-stroke petrol engines?

3. Are there any motorcycles with diesel engines?

4. What motor vehicles have diesel engines?

5. How many lorries have diesel engines?

6. How many cars have four-stroke petrol engines?

7. Are there many lorries with petrol engines?

II. Read the text about different types of fuel and engines and check your answers.

There are some basic types of fuel for motor vehicles. There is diesel fuel, there is petrol and there is fuel mixture.

Most motorcycles have two-stroke petrol engines. But there are a few motorcycles with four-stroke petrol engines. There are no motorcycles with diesel engines.

A lot of buses have diesel engines but only a few cars have such engines. There are also a few cars with two-stroke engines but most cars have four-stroke petrol engines.

Most lorries have diesel engines. There are not many lorries with four-stroke petrol engines but there are no lorries with two-stroke engines.

A lot of engines are at the front of the car. A few engines are at the back and very few are in the middle.

III. Complete the sentences.

1. There are a ... motorcycles with four-stroke petrol engines.

- 2.... motorcycles have diesel engines.
3. There are a ... cars with diesel engines.
- 4.... cars have two-stroke engines, ... cars have four-stroke petrol engines.
5. Are there ... lorries with four-stroke petrol engines? There are not ... lorries with such engines.
6. A ... of engines are at the front of the car.
7. There are a ... engines at the back and there are very ... engines in the middle.

IV. a) Fill in the table using the information from the text. One answer is already given .

	most	a few	none	a lot	few
diesel engines					
two-stroke petrol engines	motorcycles				
four-stroke petrol engines					

b) Use the information from the table above and describe what engines various vehicles have.

EXAMPLE: Most motorcycles have two-stroke petrol engines.

### Activity

I. Your partner wants to know the quantity of different things in the garage. Make up dialogues using *some, any, many, a lot of, a few, few*. Use question and answering techniques in your dialogue.

II. Translate the Russian phrases into English and reproduce the dialogue with your partner.

- Do you know what basic types of fuel for motor vehicles there are?
- Конечно. Основные виды топлива для механических транспортных средств - дизельное топливо и бензин.
- Could you tell me if there are many motorcycles with diesel engines?
- Мне кажется, что мотоциклов с дизельным двигателем не существует вообще. Но многие автобусы имеют дизельные двигатели.

- As far as I know, there are no lorries with two-stroke engines. I wonder how many lorries there are with four-stroke petrol engines?
- На самом деле, существует очень мало грузовиков с четырехтактным бензиновым двигателем. Я полагаю, большинство грузовиков имеют дизельные двигатели.
- One more question to you. Do you happen to know where most cars have their engines?
- Без сомнения, у большинства машин двигатели спереди.
- Thank you so much for your answers.
- Пожалуйста.

**III. Discuss with your partner how many cars / lorries / motorcycles have diesel engines / two-stroke engines / four-stroke petrol engines.**

## Writing

**I. Study this picture and complete the description of the 4-stroke four-cylinder engine.**

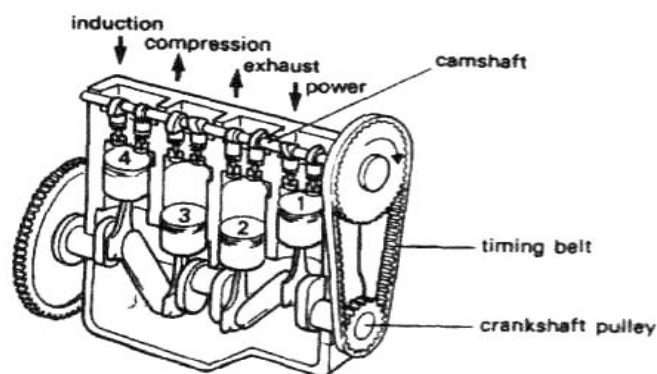

a four-stroke four-cylinder engine

The most common multi-cylinder engine is ... . The layout is normally in-line and the firing order is generally 1342. Each cylinder is always on a different stroke from all the others. When cylinder 1 is on the ... stroke, cylinder 2 is on the ..., cylinder 3 is on the ..., cylinder 4 is on the .... The main advantage of this engine is that the power ... is once every 180° of crankshaft rotation.

**II. Describe the complete cycle of operation for all the cylinders at any position of the crankshaft. Use the information from the table below.**

<i>Crankshaft position</i> <i>(degrees)</i>	<i>Cylinder 1</i>	<i>Cylinder 2</i>	<i>Cylinder 3</i>	<i>Cylinder 4</i>
	<i>(strokes)</i>			
0-180	power	exhaust	compression	induction
180-360	exhaust	induction	power	compression
360-540	induction	compression	exhaust	power
540-720	compression	power	induction	exhaust

### *Section B. Types of Fuel*

#### **Lead-in**

#### **I. Discuss the following questions.**

- Are you good at Chemistry? How many elements are there in the Periodic Table?
- What are the basic fuels that vehicles use? What are their elements?

#### **II. Listen to the following dialogues and learn how to speak about quantities of substances.**

- Instructor:* Paul, how much petrol is there in the fuel tank?  
*Paul:* Well, I am sure there is a lot of petrol there.  
*Instructor:* Will you add some into this car then, please?  
*Paul:* All right. How much?  
*Instructor:* Well, about 5 litres.
- Alex:* Michal, is there much oil in this tank?  
*Michal:* No, there isn't. There is little oil there.  
*Alex:* And how much oil is there in the tin?  
*Alex:* Could you bring and pour some into the tin, please?  
*Michal:* I'm afraid, I can't. There is too little oil in the tank.

III. That's how we express request and possible replies in English. Study this table.

HOW TO EXPRESS	REQUEST AND POSSIBLE REPLIES:	
Will you ... (please)?	(Yes), certainly.	Not at all.
Would you ... (please)?	(Yes), of course.	I'm afraid, not.
Can you ...?	Oh, sure.	Sorry, but I can't.
Could you (possibly)...?	All right.	I'm so sorry, but I can't really.
	Without any doubt.	Definitely not.
	Here you are.	

IV. Complete the dialogues using the expressions from the table above.

1.- How much diesel ... in the fuel tank?

-....

-Will you bring .....,...?

-....

- Thanks.

2.- Oleg, is there much ... in that bucket?

-..., ... .There is little....

- Would you bring ..., please?

- .... I can't.

- It's OK. Don't worry.

### Language Practice

I. Are you good at substances? Choose the right Russian translation for the English word.

- |              |                   |
|--------------|-------------------|
| 1. carbon    | a) <b>сера</b>    |
| 2. nickel    | b) <b>водород</b> |
| 3. cast iron | c) <b>углерод</b> |
| 4. rubber    | d) <b>железо</b>  |
| 5. copper    | e) <b>никель</b>  |
| 6. sulphur   | f) <b>каучук</b>  |
| 7. iron      | g) <b>сталь</b>   |
| 8. steel     | h) <b>чугун</b>   |
| 9. zinc      | i) <b>медь</b>    |
| 10. hydrogen | j) <b>цинк</b>    |

II. What chemical elements stand for these abbreviations? Ni, Zn, Fe, Cu, Al, H, S

**III. Answer your friend's questions about the quantity of different elements in these substances. Use *some*, *any*, *no*.**

EXAMPLE: *nickel / steel*

- Is there any nickel in this steel?
- Yes, there is. There is some nickel in this steel.
- No, there is not. There's no nickel in this steel.

carbon / cast iron

aluminium / alloy

copper / bronze

iron / steel

cement / concrete

**IV. Build up short dialogues using expressions of request. In your answers use *little*, *a little*.**

<p>— How much liquid is there in the vessel?</p> <p>- There's little liquid in the vessel.</p> <p>- Gould you add some more liquid, please?</p> <p>— Yes, sure. Here you are.</p>	<p>- How much liquid is there , in the vessel?</p> <p>- There's a little liquid in the vessel.</p> <p>- Don't add any liquid then.</p> <p>- All right.</p>
---	--

oil / diesel fuel

sulphur / petrol

hydrogen / diesel fuel

carbon / petrol

copper / aluminium alloys

air / fuel and air mixture

**V. Choose the right option.**

1. There is ... zinc in pure iron.  
a) plenty of    b) no    c) a little
2. There is ... carbon in carbon steel.  
a) much    b) little    c) no
3. There is ... sulphur in diesel fuel.  
a) a lot of    b) little    c) too much
4. There is too ... sand in the bucket.  
a) a little    b) little    c) no
5. There is ... cement in the concrete.

- a) plenty of    b) a little    c) no  
 6. There is ... hydrogen in water.  
 a) a little    b) much    c) no  
 VI. a) Study the following examples.

It's a half.    It's a quarter.

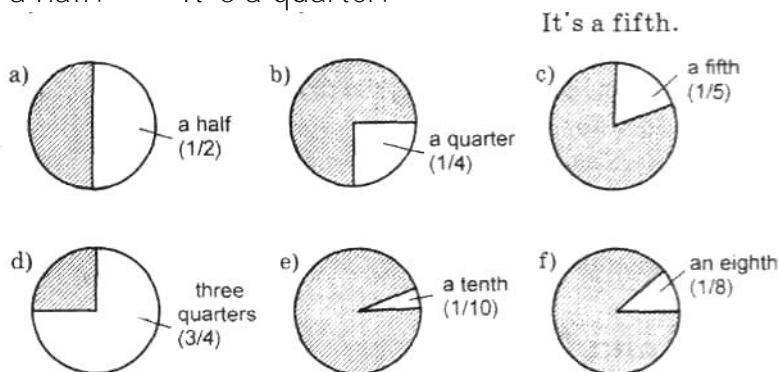

These are three quarters.    It's a tenth.    It's an eighth.

- b) Read the following sentences.  
 It's an eighth.

EXAMPLE: *Put 1/2 of the cement into the bucket.*

Put a half of the cement into the bucket.

- a) Put 1/2 of the cement into the bucket.  
 b) Pour 1/4 of the oil out of the tin.  
 c) Throw 3/4 of the water away.  
 d) Cut off 1/10 of the plank.  
 e) Please give me 1/5 of the sand.  
 f) You can use 1/8 of the gravel.

VII. Correct mistakes in the following sentences.

1. A lot of motor vehicles has petrol engines.
2. I guess there are a little vehicles with gas engines.
3. Only a few motor vehicles has mixed fuel engines.
4. I have too much questions to ask about the types of fuels.
5. How much liquid there is in the tank?
6. There are a lot of carbon in petrol.
7. Have you got some sand in this bucket?
8. We haven't got no sand in the bucket.
9. There are plenty of aluminium in most aluminium alloys.
10. There is too few petrol left. Let's go to the gas station.

VIII. Translate the following sentences into English using your active vocabulary.

1. В дизельном топливе много углерода и мало серы.
2. - Сколько бензина в топливном баке? - Я думаю, около 10 литров.

3. — Не принесешь ли ты немного машинного масла ? — Вот, пожалуйста.
4. В большинстве алюминиевых сплавах много алюминия и мало меди.
5. Горючее для четырехтактных двигателей не имеет масла.
6. В горючей смеси для двухтактных двигателей содержится большое количество бензина и совсем немного масла.
7. Не можешь ли ты мне сказать, сколько углерода содержится в дизельном топливе?
8. Сколько углерода содержится в бензине?

### Reading and Speaking

I. Scan the text and find all chemical constituents of different fuels.

II. Now read this extract for more information.

There is a lot of carbon (about 85%) in diesel fuel. There is also a lot of carbon in petrol. There is a little hydrogen in both these fuels. But there is little sulphur (about 1%) in diesel fuel and there is no sulphur in petrol. There is a great deal of petrol (about 95%) and a little oil (about 5%) in the fuel mixture for two-stroke engines. There is no oil in the fuel for four-stroke engines. There is a great deal of air (90%) and not much fuel (10%) in the fuel and air mixture.

III. Say if these sentences are true or false. Correct the false ones.

1. There is a lot of carbon in diesel fuel.
2. Petrol has a low percentage of carbon.
3. There is too much sulphur in petrol.
4. There is a lot of hydrogen both in diesel fuel and in petrol.
5. There is no oil in the fuel for four-stroke engines.
6. There is more fuel than air in the fuel and air mixture.

IV. Answer your partner's questions about the chemical composition of various fuels. Choose the right expression of quantity.

EXAMPLE: - How much carbon is there in diesel fuel? - There's a lot of carbon in diesel fuel.

a)carbon in diesel fuel	little
b)sulphur in diesel fuel	much
c)sulphur in petrol	plenty of
d)carbon in petrol	



- |  |  |          |
|--|--|----------|
| e)hydrogen in diesel fuel                              |  | a little |
| f)hydrogen in petrol"                                  |  | not much |
| g)petrol in the fuel mixture<br>for two-stroke engines |  | some     |
| h) oil in the fuel mixture for two-<br>stroke engines  |  | any      |
| i) copper in<br>aluminium alloys                       |  | no       |
|  |  | a lot of |

### Activity

**I.** You are an expert in fuels. Answer your partner's questions about various types of fuels and their composition. Use different expressions of quantity.

**II.** Study this table and discuss with your partner which type of fuel is suitable for these vehicles: *racing cars, passenger cars, motorcycles, lorries, buses.*

<i>Fuel</i>	<i>Composition</i>	<i>Price</i>
methanol	37.5% of carbon 12% of hydrogen 50% of oxygen	\$1.14
diesel	85% of carbon 0.5% of sulphur 13.5% of hydrogen	\$0.52
petrol	74% of carbon 25% of hydrogen	\$0.65
gas	100% of natural gas	\$0.74
liquid hydrogen	100% of hydrogen	\$2.17

### Writing

**I.** Study the picture. Describe the composition of:

- fuel and air mixture,
- aluminium alloy in engine fins.

Replace the percentage (...%) with expressions of quantity.

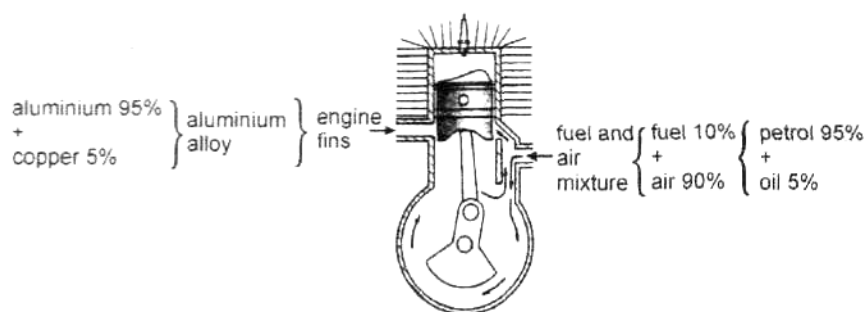

II. Translate the text into Russian. Use your dictionary if necessary.

As you know there are three types of an *internal combustion engine*<sup>1</sup> which are very important for our industrial life. These are, of course, the petrol engine, the diesel engine and the gas turbine. They have a lot in common. They all use liquid fuel, produce mechanical work and also exhaust gases. However there are many differences in the principles of their construction and operation.

Let's consider the gas turbine now. It has four characteristics. They are:

- a high *power-weight ratio*<sup>2</sup>,
- a very small number of moving parts (in comparison with the petrol engine and the diesel engine),
- independent of major water supplies,
- rapid starting (30 seconds to the full power).

---

<sup>1</sup>двигатель внутреннего сгорания

<sup>2</sup>мощность на единицу веса

## UNIT FIVE

### INSTRUMENT MAKING

#### Section A. Measuring Instruments

##### Lead-in

I. What measuring instruments do you know? List as many as you can. Compare your list with that of your groupmates.

II. Listen to the following dialogues and learn how to name different devices in English.

1. *Teacher:* I say, Paul. What is there on the table?

*Paul:* There is a device there.

*Teacher:* What is it called, Paul?

*Paul:* To my mind, it is called a manometer.

*Teacher:* Yes, right you are. And what is a manometer?

*Paul:* I believe it's an instrument for measuring pressure, isn't it?

*Teacher:* Yes, that's right. Look, it has a scale and a pointer.

*Paul:* Well, I see.

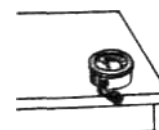

2. *Julia:* Look here, Peter! What is there on the shelf?

*Peter:* There are some measuring instruments there.

*Julia:* What are they called?

*Peter:* They are called thermometers.

*Julia:* And what is a thermometer?

*Peter:* Well, a thermometer is an instrument for measuring temperature of different bodies, liquids and gases.

*Julia:* OK, I see. Thank you, Peter.

*Peter:* You are welcome.



III. That's how we attract somebody's attention and express gratitude in English. Study this table.

HOW TO	ATTRACT ATTENTION:
Well...	Listen...
I say...	Look...
Look here.	You know...
HOW TO	EXPRESS GRATITUDE:
Thank you.	Not at all.
Thanks.	You are welcome.
Many thanks.	That's all right.
Thank you so much.	Don't mention it.
Thanks a lot.	

IV. Complete the dialogues using the phrases to attract attention and express gratitude.

1.-..., Roman! What is there in the box?

- ...
- What .... called?
- .... it's called ...

2.- ...

- It's a very important thing for a car.
- ...
- ... . It's called an ammeter.
- ...
- Well, it's a special instrument in a car for ....
- ...
- ...

### Language Practice

I. Add "-ing" to the following verbs. Pay attention to the spelling. Consult

work	} + ing	working	<b>But: lie + ing = lying</b> <b>close + ing = closing</b> <b>shut + ing = shutting</b>
stay		staying	
study		studying	
to measure		to stop	to try
to protect		to begin	to stay

to tighten    to hit        to lay  
to produce    to permit    to say

to perform    to travel    to put  
 to cut        to start     to set  
 to use        to lie        to apply

II. Match each word with the proper definition.

- |                  |  |
|------------------|--|
| a) a tyre        | 1. a device for indicating current                 |
| b) a micrometer  | 2. a tool for cutting materials                    |
| c) a speedometer | 3. a device for performing mathematical operations |
| d) a thermometer | 4. a tool for driving in screws                    |
| e) an ammeter    | 5. a thing for protecting wheels                   |
| f) a screwdriver | 6. an instrument for measuring temperature         |
| g) a calculator  | 7. an instrument for indicating the speed of a car |
| h) a chisel      | 8. a tool for measuring micro dimensions           |

III. Ask your friend to name the following instruments and tools.

EXAMPLE: *A: - This instrument is for measuring temperature. What is it called? B: - It is called a thermometer.*

1. This instrument is for indicating the speed of a car.
2. This device is for indicating current.
3. This device is for performing mathematical operations.
4. This tool is for measuring micro dimensions.
5. This tool is for cutting materials.
6. This instrument is for tightening screws.

IV. Complete the dialogues.

- a battery  1. *A: What... there in the picture? B: It... called a ... . A: It is a small battery, isn't ...? B: Yes, right you are. It... a small battery.*

a chisel



2. *A: What. ...it in the... ? B: To my mind, it's called a .... A: It's for ... metal, isn't it? B: Yes,.... It's for ... different engineering materials.*

calculators

3. *A- What are these ... ?*



*B:* I believe they ... called ....

*A:* They ... for ... mathematical operations, aren't... ?

*B:* Quite right. They ... for ... mathematical

operations.

#### **V. Correct mistakes in the following sentences.**

1. What is these called?
2. This is called a manometers.
3. What is this device to?
4. This device is for measure pressure.
5. Is this instrument for indicate the engine speed?
6. A speedometer are for indicating the speed of a car.
7. There are a few tool in the box.
8. An ammeter have a scale and a pointer.
9. This device is for cutting different engineering materials.
10. - Thank you for your help.  
- Not at all.

#### **VI. Translate the following sentences into English using your active vocabulary.**

1. - Послушай, Александр, как называется этот прибор? - Я думаю, он называется тахометр.
2. — Ты не можешь мне сказать, что такое манометр? — Я полагаю, это прибор для измерения давления, не так ли?
3. — Ты случайно не знаешь, как называются эти части автомобиля? - Двигатель и аккумулятор, если я не ошибаюсь. - Спасибо. - Не за что.
4. - Скажите, пожалуйста, для чего шины в колесах? - Они для защиты колес. Также их называют протекторами.
5. Отвертка служит для закручивания винтов.
6. - Что такое калькулятор? - Это прибор для выполнения математических операций.
7. Этот прибор называется термометр.
8. Этот инструмент используется для резки по металлу.
9. Этот прибор имеет шкалу и стрелку.
10. Спидометр используется для измерения скорости автомобиля.

## Reading and Speaking

I. Look at the picture below and guess what it is. What are these instruments called in English?

II. Now read the text and learn the functions of these instruments.

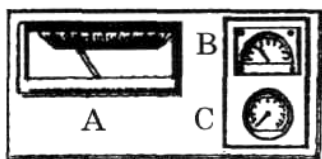

This is an instrument panel in a car. There are 3 instruments on it. Instrument A is for indicating the speed of a car. It has a scale and a pointer. It's called a speedometer. Instrument B is for indicating current. It is called an ammeter. It also has a scale and a pointer. Instrument C is for indicating the engine speed. It is called a tachometer. It has a scale and a pointer, too.

III. Answer the questions.

1. What is instrument A called?
2. What is it for?
3. What is an ammeter?
4. What is an instrument for indicating the engine speed called?
5. A speedometer has a scale and a pointer, doesn't it?

IV. Define whether the following sentences are true or false.

1. There are more than 3 instruments on the car panel in the picture.
2. A speedometer doesn't have a pointer.
3. An ammeter is for indicating current.
4. A tachometer is for indicating the speed of a car.

V. Ask your groupmate about the functions of these devices.

EXAMPLE: *a speedometer*

- What is this?
- This is a speedometer.
- What is it for?
- It's for indicating the speed of a car.

1. a speedometer
2. an ammeter
3. a tachometer

## Activity

I. Make up short dialogues using different expressions of opinion, agreement and gratitude as in the example.

EXAMPLE: - What is this called?

- I guess, this is called a screwdriver.
- Is this a tool for driving in screws?
- Yes, right you are.
- Many thanks.
- Don't mention it.

a screwdriver / for driving in screws

a speedometer / for indicating the speed of a car

an ammeter / for indicating current

a thermometer / for measuring temperature

II. Describe with your partner the functions of these instruments in the picture.

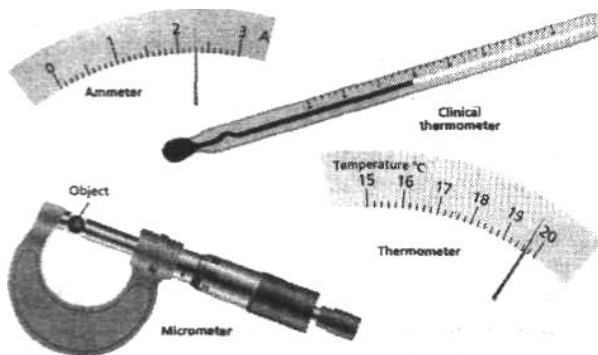

## Writing

I. Look at the pictures. Do you recognize these instruments? Give their description.

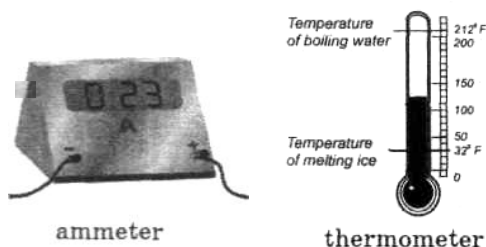



II. Translate this text into Russian.

As you know we have different devices for indicating current. They are called ammeters. Are these devices reliable? Here are several instructions for your work with them.

Check that your ammeters show zero when there is no current in the circuit.

Connect two or more ammeters in series in a circuit. **К** one ammeter has a very different reading, it is *badly calibrated*<sup>1</sup>.

<sup>1</sup> ПЛОХО КАЛИБРОВАН

### *Section B. Devices and Their Functions*

Lead-in

**I.** It is important for an engineer to know the functions of different devices. Name the functions of some devices you know.

**II.** Professor and his student are talking about the new equipment in the lab. Listen to their conversation and learn how to name measuring devices in English.

*Helen:* Professor, there is some new equipment in the lab, isn't there?

*Professor:* Yes, you are quite right.

*Helen:* I wonder what this thing is called?

*Professor:* A laser. It is known as a laser.

*Helen:* What is it used for?

*Professor:* It's used for producing a very powerful beam of light.

*Helen:* What are these?

*Professor:* As for these devices, they are known as pressure gauges.

What are they used for? What do you think?

*Helen:* They are used for measuring pressure, aren't they?

*Professor:* Right you are. And this type of gauges is used for measuring low pressures.

III. Complete the dialogue.

1. - Listen, Ivan, is there any new ... in the workshop?

- ...

- Do you know what...?
- ...
- What is this device ... ?
- ... for calculating.
- And these are used for ..., aren't...?
- ... These are ammeters.
- ...
- ...

Language Practice

I. Choose the proper definitions for the words.

<ul style="list-style-type: none"> <li>a gauge</li> <li>a microscope</li> <li>a computer</li> <li>a laser</li> </ul>	is   know   n as	<ul style="list-style-type: none"> <li>a device for studying materials' structure</li> <li>a device for measuring low pressures</li> <li>a device for producing a powerful beam of light</li> <li>a device for calculating at high speeds</li> </ul>
--	------------------------	--

II. Rephrase the following.

EXAMPLE: A: *We measure pressure with the help of a manometer.*

B: It is used for measuring pressure.

1. We measure high temperature with the help of a pyrometer.
2. We transport people and goods with the help of a car.
3. We make holes with the help of an electric drill.
4. We measure distances with the help of a laser.

III. Ask your groupmate to name the defined word.

EXAMPLE: A: *This is a device for performing mathematical operations.*

*What is it called?*

B: It is called a calculator.

1. This is an instrument for measuring time.
2. This is a device for measuring low pressure.
3. This is an instrument for measuring speed.
4. This is a device for producing a powerful beam of light.

IV. Answer your friend's questions about the functions of these devices.

EXAMPLE: a) - *What device is it?*

- This device is known as a laser.

- What is it used for?
- It is used for producing a powerful beam of light.

- a) a laser / to produce a powerful beam of light
- b) a manometer / to measure pressure
- c) an electric drill / to make holes
- d) a chisel / to cut different engineering materials
- e) a computer / to calculate at high speeds

V. Fill in the gaps.

- What ... it?
- It is a device.
- What is it...?
- This device is called a manometer.
- Is it ... for measuring pressure?

- Yes, right you .... A manometer is used ... measuring pressure.
- It has a scale and a pointer, ... it?
- That... right. The manometer ... a scale and a pointer.

VI. Translate the following sentences into English.

1. Не знаете ли вы, как называется этот предмет? - Несомненно, это весы.
2. Насколько я знаю, существуют различные типы весов.
3. Если я не ошибаюсь, этот станок используется для обработки деталей.
4. Я полагаю, этот прибор используется для измерения температуры.
5. Этот прибор известен как лазер, не правда ли?
6. И ещё вопрос, для чего используется этот инструмент?
7. — Интересно, что такое манометр? - Мне кажется, этот прибор используется для измерения давления в шинах.
8. Этот прибор имеет собственный источник энергии и линзы.
9. Кстати, как называется прибор для измерения давления?
10. По-моему, лазер используется для получения мощного пучка света.

## Reading and Speaking

I. Look at the pictures on page 75. Try to name these objects and their functions.

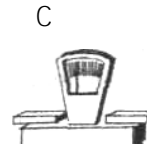

**II. Find answers to the following questions in the text.**

1. What is instrument **A** called?
2. What is it used for?
3. What is instrument **B** called?
4. What is the scale used for?
5. What is instrument **C** known as?
6. What is it used for?

There are different instruments in the picture. Instrument **A** is known as a manometer. It's used for measuring pressure. It has a scale and a pointer. Instrument **B** is defined as scales. They have two pans. They are used for measuring weights. There are different types of scales. Instrument **C** is known as a ruler. It is used for drawing straight lines and different shapes. It has marks and numbers on it.

**III. Fill in the table using information from the text following it.**

<i>Device or thing</i>	<i>Main components</i>			<i>Usage</i>	
	a power source, lenses		a manipulator, a drive, a control unit	for communicating	for producing a beam of light
a laser a car ...					/



Number 1

Number 1 is known as a laser. This device is used for producing a very powerful beam of light. It has its own power source and several lenses.



Number 2

Number 2 is known as a telephone. This is an apparatus for communicating. It has a receiver.



Number 3

Number 3 is known as a car. This vehicle is used for transporting passengers and goods. Every car has four wheels and an engine.



Number 4

Number 4 is defined as a robot. It is used for performing different jobs instead of human beings. It has a manipulator, a control unit and a drive.

### Activity

I. Ask your friend what the following objects are and what they are used for.

EXAMPLE: *A:* - What's this called, Boris?

*B:* - I think this is called an ammeter.

*A:* - And what is it used for?

*B:* — Oh, it's used for measuring current.

a thermometer      a hammer

a computer          a gauge

a camera

II. Choose one of the objects and describe it to your groupmate. Let him guess what it is.

EXAMPLE:

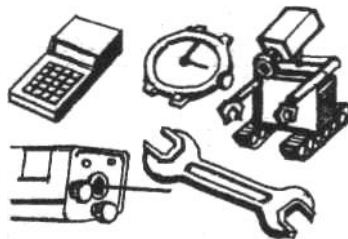

*A:* Boris, it's a thing for tightening screws. What's it called?

*B:* I think it's a screwdriver. Here it is.

*A:* Yes, you are quite right.

## Writing

### I. Complete these sentences.



1. This tool... known ... a hammer. It's ... for ... in nails. It... a wooden ... and a metal....



2. There are some ... in the picture. They ... called a ... and a .... They are ... for ... metal and wood. They have also wooden ... and metal....

### II. Translate the text into Russian.

Any instrument for measuring electricity is known as an ammeter. An ammeter is used for measuring current in amperes. The abbreviation for the ampere is amp. There are very delicate ammeters that are used for measuring very small current. They are known as a milliammeter and a micro ammeter. The device for reading a thousandth of an ampere is called a milliammeter while a micro ammeter is a device for reading a millionth of an ampere.

## UNIT SIX

### ENGINEERING MATERIALS

#### *Section A. Metals and Non-metals*

##### Lead-in

I. List the materials you know which are used in engineering. Combine your list with that of your friend and say which of the materials are metals and non-metals.

II. Some students and their Instructor are discussing the materials that are used for making tools and instruments. Listen to their dialogue and learn how to name engineering materials.

1. *Julia:* Is this a workshop?

*Instructor:* Yes, you are quite right. It is a workshop and there are many tools for your practice here. They are made of different engineering materials.

*Paul:* What are these materials called?

*Instructor:* They are called plastic, glass, wood, rubber and metal.

*Michael:* I think steel, iron and copper are widely used for making tools.

*Instructor:* That is right. These metals are widely used for making bolts, screws, pipes, rods, nuts, wires, etc.

2. *Paul:* Look. There is a box of nuts and bolts. They are made of steel.

*Julia:* And that wire is made of copper, isn't it?

*Michael:* Yes, it is. What about this hammer? Is it made of copper too? *Paul:* No, it is not. It is made of wood and steel. The handle is

made of wood and the head is made of steel.

*Julia:* Michael, give me that beaker, please.

*Michael:* Be careful, Julia. Don't drop it. It is made of glass. Put it here on this shelf.

### III. Complete the dialogues with suitable words.

1. - ... a workshop?  
- ... and there are many ... .  
- What are they made of?  
- They... .
2. - ... . What is this box made of?  
- And by the way, is its lid ..., too?  
- Can I have it?

#### Language Practice

##### I. Match the English phrases with the Russian equivalents.

1. cast iron
2. a plastic box
3. a steel pipe
4. a copper cup
5. a glass vase
6. an iron bolt

- a) пластмассовая коробка
- b) железный болт
- c) стеклянная ваза
- d) чугун
- e) медная чашка
- f) стальная труба

##### II. Rephrase the following sentences and translate them into Russian.

EXAMPLE A: *This wire is made of copper.* This is a copper wire.

1. This rod is made of metal.
2. This handle is made of ...
3. This tin is made of aluminium.
4. This beaker is made of glass.

EXAMPLE B: *This is a steel blade.*

This blade is made of steel.

1. This is a plastic cover.
2. This is a copper pipe.
3. This is a plastic ruler.
4. This is an iron bolt.

### III. Give instructions to your groupmates.

EXAMPLE: *steel / ruler / wooden*

Helen, don't use the wooden ruler

(rulers). Use the steel one (ones).

metal / tray / plastic  
rubber / pipe / copper  
glass / rod / plastic  
concrete

iron / bolts / steel  
copper / nuts / steel  
wooden / beams /

IV. Complete the dialogue, a tin - metal





a chisel:  
handle - wood  
blade - steel

tyres - rubber

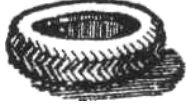

nails — iron



*Paul:* What is this device ... of?

*Julia:* It... made of ... .

*Paul:* What... it called?

*Michal:* ... is called a ....

*Paul:* What ... the handle of the chisel  
... of?

*Michal:* ... is made of ... .

*Paul:* The blade ... of ..., isn 't it?

*Michal:* Yes... The blade... of steel.

*Julia:* What... these tyres ... of?

*Paul:* ... are made of ... .

*Julia:* ... is a tough material, isn't...?

*Paul:* ..., it is. ... is used for ... tyres.

*Michal:* What... these nails of?

*Julia:* ... are made of ... .

*Michal:* ... is a hard ..., isn't it?

*Julia:* ..., it is. ... is a very .. material.

V. Correct mistakes in the following sentences.

1. This beaker is made from glass.
2. This beam made of concrete.
3. What is the chisel made?
4. This steel pipes are made of cast iron.
5. Tyres is usually made of rubber.
6. The device for measuring temperature is known a thermometer.
7. The metre ruler is used for measure lengths and widths.

VI. Translate the following sentences into English using your active vocabulary.

1. Эти инструменты сделаны из различных технических материалов.
2. Существует два типа технических материалов: металлы и неметаллы.
3. Сталь, медь, литейный чугун широко используются для изготовления болтов, винтов, гаек.
4. Как металлы, так и неметаллы обладают определенными свойствами, поэтому они широко используются в производстве технических изделий.

5. Резина - очень прочный материал.
6. Ручка этого молотка сделана из дерева, а обух - из стали.
7. - Олег, дай мне, пожалуйста, эту стеклянную колбу.
8. Будь осторожен, не урони этот предмет. Он сделан из стекла.
9. - Дмитрий, не используй этот медный провод, используй стальной.
10. Пластик - очень легкий материал.

## Reading and Speaking

### I. Try to answer these questions before you read the text.

1. What groups are all engineering materials divided into?
2. Where are different metals used?
3. There are ferrous and non-ferrous metals, aren't there?
4. Are steel and cast iron ferrous or non-ferrous metals?
5. What are non-ferrous metals?
6. What are the characteristics of non-ferrous metals?

### II. Read the text attentively and check your answers.

All engineering materials are divided into metals and non-metals. Copper, cast iron, aluminium are examples of metals. Rubber, plastic and ceramics are examples of non-metals. Today different metals are widely used in machine-building industry.

We can divide all metals into ferrous and non-ferrous. Steel and cast iron are in the group of ferrous metals. They are alloys of iron with carbon, manganese, silicon and other components.

Non-ferrous metals are metals and alloys the main component of which is not iron but some other element such as aluminium, copper and others. Some of the characteristics of non-ferrous metals are high electric and heat conductivity, high corrosion resistance, light weight and easiness of fabrication.

### III. Find the proper continuation of the sentences according to the information in the text.

- |  |                               |
|--|-------------------------------|
| 1. All engineering materials are divided into ...    | a) aluminium.                 |
| 2. Ferrous metals have ...                           | b) metals and non-metals.     |
| 3. The characteristics of non-ferrous metals are ... | c) machine-building industry. |
|  | d) ferrous metals.            |

- 4. One of the main components of non-ferrous metals is ...
- 5. We use different metals in ...
- 6. Steel and cast iron are examples of ...

- e) iron with carbon, manganese, silicon and other components.
- f) high electric and heat conductivity, high corrosion resistance, light weight, etc.

IV. Say whether you agree or disagree with these statements.

- 1. All engineering materials are divided into metals and non-metals.
- 2. Steel, iron and copper are widely used for making tools.
- 3. One of the main characteristics of ferrous metals is high corrosion resistance.
- 4. Aluminium and copper are the main components of non-ferrous metals.
- 5. Plastic is a heavy material.
- 6. Rubber is a very tough engineering material.

V. Fill in the gaps.

- 1. Ferrous metals are ... of iron ... carbon, manganese, silicon and other components.
- 2. People use various metals ... machine-building ....
- 3. We can divide all engineering materials ... metals and non-metals.
- 4. Steel and cast iron are ... the group of ... metals.

VI. Fill in the table with the following engineering materials:

*iron, glass, aluminium, wood, cast iron, plastic, copper, steel, rubber.*

METALS	NON-METALS
a) FERROUS 1. 2. 3.	1. 2. 3. 4.
b) NON-FERROUS 1. 2.	

## Activity

**I.** Ask your groupmates what materials the following objects are made of:

a beaker, a bolt, a pipe, a wire, a cylinder, gloves, shelves, nuts, screws

**II.** Give answers to the given questions and reproduce the dialogue with your partner.

- There are two kinds of engineering materials, aren't there?
- What are they?
- Can you give me any examples of non-metals?
- Sure. ...
- Are engineering materials widely used?
- Certainly. ...

**III.** Name the objects around you and say what materials they are made of.

## Writing

**I.** Describe this tank according to the information from the table.

<i>part of the tank</i>	<i>material</i>	<i>its quality</i>
1. sides 2. lid 3. pipe at the top 4. pipe at the bottom	steel rubber plastic copper	strong tough light heavy

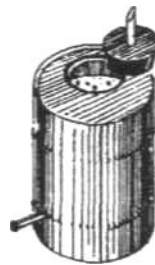

**II.** Translate the passage into Russian.

Chemical elements are metals or non-metals. They are widely used in making tools, instruments and devices. Metals and non-metals have different properties.

The combination of metals and non-metals is known as an alloy. For example, steel is an alloy of iron and carbon. The alloy of copper and zinc is known as brass. The properties of alloys are often better than the properties of their constituents. That is why the majority of engineering products are made of various alloys.

## *Section B. Properties of Engineering Materials*

### **Lead-in**

**I.a) Why is it important for an engineer to know the properties of engineering materials?**

**b) List the properties you know. Compare your list with that of your friend.**

**II. A group of students is at the practical class now. Listen to their conversation and learn how we can compare properties of various materials.**

1. *Paul:* Alex, help me, please. This pipe is very heavy.

*Alex:* Is it really? What material is it made of?

*Paul:* Actually, it is made of metal.

*Alex:* Why is it made of metal?

*Paul:* Well, because it is a strong material. In any case, it is stronger and more rigid than rubber.

*Alex:* Is it an expensive material?

*Paul:* Yes, it is. It is the most expensive material, as a matter of fact.

2. *Alice:* Paul, take that pipe, please. It is rather light.

*Paul:* Oh! It is very light. What material is it made of?

*Alice:* It is made of plastic.

*Paul:* Why is it made of plastic?

*Alice:* Well, it is a rigid material, but it is less flexible than rubber. In fact, it is the lightest and the least expensive material.

**III. That's how we can begin a phrase in English. Study the table on page 85**

OPENING WORDS AND		PHRASES:
On the one hand...	On the whole...	Well...
On the other hand...	Fortunately...	So...
Anyway...	Luckily...	Thus...
In any case...	Unfortunately..	By the way...
	Actually...	You know...
		You see...
		As a matter of fact...

**IV. Complete the dialogue. Use the opening words and phrases from the table above.**

- Look here, .... I bet that... is very heavy!
- I'm sure it is not!
- Hmm, ... what material...?
- ..., to my mind ... .
- ... not! Can't you see?! It's made of ... . - ...strong?
- Well, on the one hand, it is ... than ... . On ..., it is less ... than ... .

**Language Practice**

**I. Complete the table.**

long - longer - the longest	rigid - more rigid - the most rigid
long - less long - the least long	rigid — less rigid - the least rigid
strong - ... - ...	plastic — ... - ...
heavy- ... - ...	elastic -...-...
hard - ... - ...	brittle-...- ...
soft-...-...	flexible - ... - ...
cheap — ... — ...	expensive — ... — ...
	valuable -...-...

**II. Compare the properties of different substances.**

EXAMPLE: It *plastic - weak rubber - ?*  
 Rubber is weaker than plastic.

1. plastic — strong
2. aluminium - hard

metal - ? copper - ?

3. aluminium - light                      rubber - ?  
 4. cast iron - soft                         aluminium — ?

EXAMPLE 2: *plastic - flexible*    *rubber - ?*  
 Rubber is more flexible than plastic.

1. rubber - rigid                             steel - ?  
 2. wood - brittle                            glass - ?  
 3. steel - plastic                            copper - ?  
 4. steel - elastic                            rubber - ?

III. Complete the sentences with these words: *rigid, soft, elastic, hard, brittle, expensive, valuable*. Translate them into Russian.

1. Gold is the...of the metals.
2. Glass is ..... than cast iron.
3. This tank is the ... one because it is made of steel.
4. This material is the ... of these new materials.
5. The ... of these materials is aluminium.
6. Copper is ... than rubber.
7. This metal is more ... than iron.

IV. Complete the table with the nouns for each property.

<i>Properties of Materials</i>	
Adjective	Nouns
flexible	flexibility
hard	•••
soft	...
plastic	...
elastic	•••
tough	...
strong	...

V. Rephrase the following sentences. The table above will help you.

EXAMPLE: *material / flexible*  
 This material is very flexible.  
 It has the property of flexibility.

- glass / hard                                 steel / elastic  
 aluminium / soft                         metal / tough  
 copper / plastic

## **VI. Correct mistakes in the given sentences.**

1. This pipe is made of plastic because it's a rigider material than rubber.
2. Rubber is the most elastic than steel.
3. Metal is more stronger than plastic.
4. Glass is brittler than wood.
5. This tank is the harder one because it's made of steel.
6. This material is very flexible than that one.
7. What material this pipe is made of?
8. Copper is harder then aluminium.

## **VII. Translate the following sentences into English using your active vocabulary.**

1. Этот материал самый ценный из всех (материалов).
2. Мне кажется, эти трубы легкие, потому что они сделаны из пластика.
3. С одной стороны, пластик - менее гибкий материал, чем резина, но, с другой стороны, он самый легкий и наименее дорогой материал.
4. Он обладает свойством пластичности, поэтому этот материал широко используется.
5. Литейный чугун - тяжелый, но он легче, чем медь.
6. Стальные трубы - самые тяжелые и наименее гибкие.
7. Титан и алюминий легче литейного чугуна и стекла, но тверже резины.
8. Эти пружины сделаны из стали, потому что сталь — эластичный металл.
9. Стекло - очень хрупкий материал.
10. Сталь — самый эластичный материал из всех этих материалов.

## **Reading and Speaking**

### **I. Try to answer these questions before you read the text.**

1. What are the most widely used metals in engineering?
2. What colour are these metals?
3. What metal is the hardest one: steel, aluminium or copper?
4. Copper is the heaviest metal, isn't it?
5. What metal is stronger: aluminium or copper?
6. What metal is more flexible: copper or steel?
7. Is aluminium the most or the least flexible metal?



II. Read the text and check your answers.

Steel, copper and aluminium are widely used in engineering. Steel is a grey elastic metal. It is heavier than aluminium, but it is the hardest and the strongest of those three metals. That is why it is widely used for constructing bridges, making tools and car components.

Copper is a red metal. It is harder and stronger than aluminium and more flexible than steel. Electric wires are generally made of copper because this metal has a high electric conductivity. However, copper is the heaviest metal of the three.

The lightest and the most flexible of these materials is aluminium, therefore aircraft, engine components and many kitchen items are made of this metal. Aluminium is a white hard metal.

III. Find the endings of these sentences.

Steel, copper and aluminium are widely used ...	a red material, aluminium,
Steel is the hardest and the strongest of ...	in engineering,
Copper is ...	the three metals,
Steel is...	a grey elastic metal.
The lightest and the most flexible is ...	

IV. Complete the sentences.

Different metals ... widely ... in ... . Steel is a grey... metal. It is ... than aluminium. Copper is a red .... Steel is harder and stronger ... copper, but copper is ... flexible than steel. Copper is the ... . Aluminium is the ... flexible material. Steel is ... hardest and the ... of these three materials.

### Activity

I. Ask your groupmate to name the following objects and say what materials they are made of.

EXAMPLE: *ruler / plastic*

*Paul:* Look! This is called a ruler.

*Susan:* By the way, what material is it made of?

*Paul:* It is made of plastic.

*Susan:* Why is it made of plastic?

*Paul:* Because plastic is a light material, it is lighter than steel. And it is the least expensive material. Therefore it is used for making rulers.

*Objects / materials*      a wire / copper  
 a cylinder / steel a      a pipe /meted  
 tyre /rubber a              a tin / aluminium  
 beaker / glass

**II. Discuss with your partner the following questions.**

1. Why are bridges made of steel, not of copper?
2. Why are electric wires made of copper, not of plastic?
3. Why are aircraft made of aluminium, not of steel?
4. Why are cutting tools made of steel, not of pure iron?

**Writing**

**I. Study this table and write a passage explaining why these materials are used for making these things.**

7

<i>Materials</i>	<i>Properties</i>	<i>Application</i>
aluminium	light, soft, corrosion-resistant, highly conductive	engine components, aircraft
copper	heavy, tough, corrosion-resistant, highly conductive	electric wiring, tubing
mild steel (iron with 0.15-0.3% of carbon)	very strong, tough, non-resistant to corrosion	general purposes
high carbon steel (iron with 0.7-1.4% of carbon)	hardest of carbon steels, tough, wear-resistant*	cutting tools (drills, files, saws, etc.)

\* ИЗНОСОСТОЙКИЙ

## **II. Translate the passage into Russian.**

It's impossible to live without metals. The main advantage of metals is their strength and toughness. Concrete is used in building because it has steel for strength. Plastics are lighter than metals but they are not usually very strong.

Not all metals are strong, however. Copper and aluminium, for example, are both fairly weak. But the alloy of these metals, which is called aluminium bronze, is much stronger than pure copper or pure aluminium. In general, alloys are used for obtaining special valuable properties, such as strength, toughness, resistance to wear, magnetic properties, high electrical resistance or corrosion resistance.

## CHECK YOUR PROGRESS

I. a) Fill in the blanks in this diagram with the branches of engineering that you know.

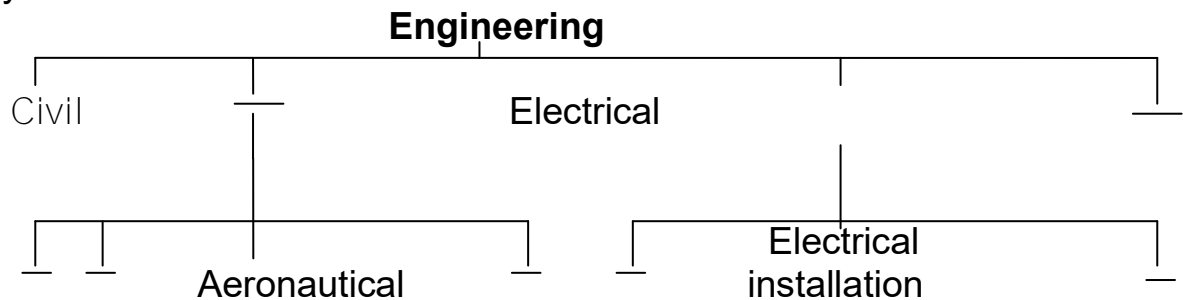

b) Read this text for additional information and complete the diagram.

Engineering is a very practical activity. It is the process of applying the latest achievements of science and technology into practice.

There are a lot of branches in engineering. Mechanical engineers are experts in the design and manufacture of tools and machines. Mechanical engineering has marine, automobile, aeronautical, heating and ventilating branches.

Electrical engineering *deals with*<sup>1</sup> producing and applying electricity in various fields of national economy. It has the following branches: electrical installation, electrical generation, lighting, etc.

Components and equipment for computing and communicating are the products of electronic engineering. Civil engineering deals with constructing bridges, roads and airports.

---

<sup>1</sup> *имеет дело*

c) Match each branch of engineering with its products.

1.civil a)planes

2.electronic

b)ships

3.automobile

c) wires

4.electric

d)roads and bridges

5.heating and ventilating

e)cars and lorries

6.marine

f)air-conditioning

7.aeronautical

g) computers

II. The following adjectives are used for giving precise description of objects. Arrange the adjectives in three groups accordingly.

shape	material	properties of materials
	...	

light, circular, copper, brittle, cylindrical, flexible, glass, gold, oval, iron, elastic, rectangular, rubber, rigid, round, square, tough, strong, cast iron, triangular.

**III. Read the description of the first picture, complete the description of the second picture and make the third description yourself.**



1.

This is a big rectangle. Inside the rectangle there is a circle, a small square and three triangles. On the left at the top there is a small circle. On the right at the top there is a small square. In the middle there are three small triangles. On the right at the bottom there is a point.

2.



This is a big ..the triangle ...  
 the left there is a ... . At the ...  
 there is a .....Outside the tri  
 angle on the ... there is a .  
 Outside the triangle on the ... there is a small...  
 near the top.

3.

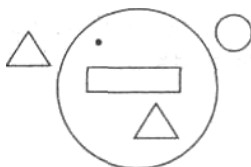

**IV. Fill in the gaps using the proper preposition.**

1. This device is made ... plastic.
2. These metals are widely used ... making bolts, screws, pipes, rods, nuts, wires.
3. This is a tool... turning in screws.
4. We make holes ... the help ... an electric drill.
5. There is a lot... carbon ... diesel fuel.

6. We have got plenty ... petrol in the petrol tank.
7. There are not many lorries ... four-stroke petrol engines.
8. There are two cars ... this garage.
9. The length ... the ruler is 1m.
10. This tank is full ... liquid.

**V. Ask your friend to name the following instruments and tools.**

EXAMPLE: *Maria*: This object is made of plastic and steel.

The blades are made of plastic and the guard is made of steel. It is used for airing. What is it? *Oleg*: This is a fan.

1. This object is made of wood and metal. It has a handle and a blade. It is used for ...
2. This object is made of wood and steel. It has a head and a handle. It is used for ...
3. This object is normally made of wood and plastic. It is rectangular and has a handle. It is used for ...
4. This object is made of plastic and steel. It has a handle and a blade. It is used for ...
5. This object is made of wood and iron. It has four sides and a lid. It is used for ...

Answers: *a door, a hammer, a knife, a chisel, a box.*

**VI. Solve the following problems.**

- a) A rectangle is 1.35 cm wide, 7.05 cm long. Define its area.
- b) A parallelepiped is  $\frac{1}{3}$  m long,  $\frac{1}{4}$  m high and  $\frac{2}{9}$  m wide. Define its volume.

**VII. Play the guessing game. Think of an object and your friend must find out what it is. He can ask no more than ten questions.**

Possible questions:

- Is it made of wood/metal/glass/ ...?
- Is it useful? Is it liquid?
- Is it hard/soft/heavy/light/ ...?
- What's the shape of the object?
- What's the width/length/height of it?
- Is there one in this room?
- Is it on/under the table?

...

**VIII. Do the engineering materials quiz. Is there anyone in your group who knows all the answers?**

1. What material is the most flexible?  
a) rubber    b) glass    e) plastic
2. What material is the weakest?  
a) steel      b) rubber    c) plastic
3. What metal is the most expensive?  
a) aluminium    b) copper    c) steel
4. What material is the lightest?  
a) metal      b) rubber    c) plastic
5. What metal is the most plastic?  
a) aluminium    b) copper    c) steel
6. What material is the least flexible?  
a) steel      b) rubber    c) plastic

**IX. Fill in the blanks with the following:**

**a) *many, much, a lot of***

1. Measure as ... objects as possible.
2. Is there .. water in the vessel?
3. Pour ... liquid into the beaker.
4. Are there ... instruments in the box?
5. There is ... oil in the tin.

**b) *few, a few, little, a little***

1. They have too ... time for experiment.
2. There is ... fuel in the tank. We need some more.
3. There are only ... nails on the worktable.
4. There is ... cement in the sack. That is enough.    -
5. There are ... spare tyres in my garage.

**X. Correct mistakes in the following sentences.**

1. Let me to introduce myself. My name's Andrew Kosov.
2. Who is this man? - He's an engineer.
3. What a shape is the box? - The box is rectangular.
4. Are these objects have different shapes?
5. How width is the block?
6. The long of the wall is 7 m.
7. The screw is the shortest than the nail.
8. How many motor vehicles there are with mixed fuel engines?
9. Are there some motorcycles with gas engines?
10. This instrument is used to indicating the speed of a car. It's called a speedometer.

## XI. Translate from Russian into English.

### A

1. Иванов - студент-первокурсник.
2. Он — студент технического вуза.
3. Что это? - Это круги, квадраты, линии.
4. Этот бак пустой или полный?
5. Это шины, не так ли?
6. Какой формы этот предмет? - Я думаю, он прямоугольный.

Две стороны у него параллельны.

7. Какая ширина, высота и длина этой комнаты?
8. Между прочим, эта труба толще, длиннее и шире, чем та.
9. Объемы этих блоков разные.
10. Где инструменты? — Молоток и отвертка - на рабочем столе, а гаечный ключ и дрель - в ящике справа от верстака.
11. - Дай мне, пожалуйста, гвозди. - Они в ящике с гайками и шурупами.
12. Существуют различные виды двигателей - с воздушным и водным охлаждением.
13. Насколько мне известно, бензиновые двигатели имеют свечи зажигания.

### B

1. Знаешь ли ты, какие мотоциклы имеют двухтактные бензиновые двигатели?
2. - Сколько машин в гараже? — Я точно не знаю, но думаю, что не много.
3. У них есть несколько запасных частей к автомобилю.
4. Сколько бензина в канистре?
5. Насколько я знаю, в большинстве алюминиевых сплавов много алюминия и мало меди.
6. Может, ты мне скажешь, сколько масла в этой горючей смеси?
7. Как называются эти запчасти для автомобиля?
8. - Этот прибор называется спидометр, не так ли? - Да, ты прав.
9. Калькулятор — это устройство для выполнения математических операций.
10. - А что это за прибор? - Этот прибор известен как лазер. Давай поработаем с ним.
11. Из чего сделан этот предмет?
12. Я думаю, что этот инструмент сделан из стали.
13. Медь, чугун и алюминий - это примеры металлов.

## XII. Try the crossword. If you do it correctly you will get a liquid metal in No 1.



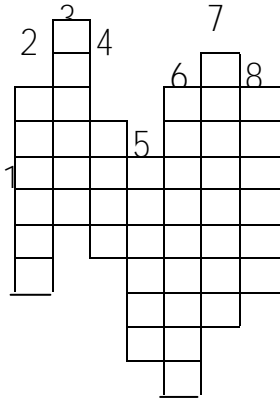

*Across:*

1. ...?

*Down:*

2. It is used for making concrete.
3. An extremely flexible material.
4. A chemical element, "ferrous metal."
5. There is a lot of ... in diesel oil.
6. There is much ... in most aluminum alloys.
7. Without this element water is impossible.
8. This gas is used for breathing.

**XIII. When you apply for a job you need to write a CV. Study this example below and write your own CV.**

<i>Curriculum Vitae</i>	
Personal details	Name: Alexey Kosov Date of Birth: 21 January 1985 Marital Status: Single Nationality: Belarusian Address: 12. Skarvna Ave. 27 Minsk. 220012. Belarus Tel: 275-12-12 e-mail: alexey@yahoo.com
Education 2003-to present	Belarusian National Technical University, Mechanical Engineering
1992-2003	Secondary School #119
Work Experience	Mechanic apprentice at a service station
Languages	Russian, Belarusian, English(fluent), German(working)
Interests and Activities	Sports, computers, automobiles, travel
Other Information	Clean driving licence
References available	upon request.

## EXPERIMENTING

### *Section A. Experimenting with Car Devices*

Lead-in

#### **I. Discuss the following questions.**

- a) Is experimenting important for the development of technology? If so, give your reasons.
- b) In what spheres of engineering can people use experiments?

#### **II. Paul and Alex are in the lab now. Listen to their conversation and name the car devices they are working with.**

*Alex:* Hello, Paul! How are you doing?

*Paul:* Hi, Alex. I'm great, thanks. And you?

*Alex:* Not bad. What are you doing here?

*Paul:* Well, I'm studying some car devices. For example, this one is called a tachometer.

*Alex:* A tachometer? And do you know what it is used for?

*Paul:* Sure, it is used for indicating the engine speed. It is called a revolution counter. You see, now it is indicating 2500 rpm. It means that the engine is turning over quite fast.

*Alex:* And what is this instrument? What is it indicating?

*Paul:* This one is called an ammeter. At the moment it is indicating +10A.

*Alex:* Well, I see.

*Paul:* By the way, we are writing a test on car devices tomorrow.

*Alex:* Really? Then I'm staying with you in the lab.

*Paul:* OK, then.

### III. Complete the

dialogues.

A.

A: ...

B: I'm fine, thanks ...

A: ...

B: I'm studying the car design. A What is it used

A: ...

B.

A ...

B: It is called a tachometer.

C.

A: What is this revolution counter indicating now?

B: ... It means that ...

A: ...

B: And this ammeter is indicating +12A at the moment.

A I see.

### IV. Match a line in A with a line in B.

1. How are you doing?

2. What are you doing here?

3. What is a revolution counter used for?

4. Are you writing a test tomorrow?

5. What is an ammeter?

6. Is the tachometer indicating 750 rpm now?

a. It is used for indicating the engine speed.

b. It is a device that is used for measuring current.

**c Yes, it is.**

d. We are testing some car devices here.

e. I'm excellent, thanks.

f. Yes, that's why I'm staying in the lab.

## Language Practice

### *Vocabulary*

#### I. Match the English words with their Russian equivalents.

1. current, n            a) выполнять

2. perform, v            b) чинить

3. investigate, v        c) скорость

4. charge, v            d) ток

5. speed, n              e) изучать

6. repair, v              f) заряжать

**II. Match the words from both columns to make all possible word combinations.**

- |                 |               |
|-----------------|---------------|
| 1. car          | a) counter    |
| 2. instrument   | b) panel      |
| 3. revolution   | c) design     |
| 4. mathematical | d) vehicle    |
| 5. motor        | e) operations |

*Grammar: Present Progressive Active*

**III. Write down the *-ing* form of these verbs.**

- |           |            |
|-----------|------------|
| move -    | test -     |
| pay -     | measure —  |
| perform - | indicate — |
| do -      | work -     |
| put -     | study -    |

**IV. Say what is true for you and your groupmates now.**

EXAMPLE: I / *study English.*  
              They / *watch TV.*

I am studying English.  
They are not watching TV now.

1. I / listen to the teacher.
2. We / practise a new grammar rule.
3. He / perform mathematical calculations.
4. I / drive a car.
5. We / sit in the class.
6. They / measure the dimensions of this room.

**V. You are now at the lab class with your groupmates. Ask each other what they are doing.**

EXAMPLE 1: *to study the instrument panel of the car / car design*

A: Are you studying the instrument panel of the car?

B: Yes, I am. I 'm studying the instrument panel of the car.

or B.- No, I am not. I 'm studying the car design.

to look at the indications of a speedometer / tachometer

to repair the car / tyre

to test the new device / new engineering materials

to check the volume of the petrol / oil

EXAMPLE 2: *to measure the pressure in the tyre / to change the wheel*

A: Are they measuring the pressure in the tyre?

B: Yes, they are. They are measuring it.

or B: No, they aren't. They are changing the wheel.

to drive in nails / to tighten screws

to cut wooden blocks / to cut metal sheets

to use chisels / to use hammers

to shape workpieces / to measure their dimensions

EXAMPLE 3: *to test the new engine*

A: What are you doing?

B: I am testing the new  
engine new.

What is he doing? He is testing the new engine now.

to perform mathematical operations

to investigate the properties of copper

to control the quality of engineering materials

to work with wood

**VI. Put all possible questions to the following statements. Consult the table.**

	<i>Paul</i>	is	<i>carefully studying</i>	<i>a new device</i>	<i>in the lab</i>	<i>now.</i>
Is	Paul		carefully studying	a new device	in the lab	now?
What	is Paul		carefully studying		in the lab	now?
What	is Paul		carefully doing		in the lab	now?
Where	is Paul		carefully studying	a new device		now?
How	is Paul		studying	a new device	in the lab	now?
When	is Paul		carefully studying	a new device	in the lab?	
Which	is Paul		carefully studying		in the lab	now?
device						
	Who	is	carefully studying	a new device	in the lab	now?

1. The battery is discharging rapidly.

2. The students are testing the new engineering materials.

3. The driver is measuring the pressure in the wheels.

4. This car is moving at the speed of 70 kph now.

**VII. Give your partner more information about what these people are doing.**

EXAMPLE: *Oleg - to drive a car - to do it carefully*

A: Oleg is driving a car, isn't he?

B: Yes, that's right. He is driving a car and he is doing this very carefully.

Michael - to increase the speed - to watch the indications of the speedometer;

Andrew - to turn the key clockwise - to start the engine;

Paul - to test the device - to describe the results of the test;

Paul and Alex - to measure the pressure in the wheels - to put air in the tyres;

Anna — to draw different objects — to define their area.

**VIII. Make up some questions for the following answers. The answers needn't be true.**

1. It is used for indicating current.
2. Right now.
3. Motor Engineering.
4. A new modern car.
5. It's called a speedometer.
6. Yes, they are.

**IX. Correct mistakes.**

1. The speedometer is indicate 60 kph.
2. We not performing mathematical operations.
3. Are the car moving now? /
4. The alternator is not produceing enough current now.
5. Paul, what is you doing here?
6. Ann is driving a new car, is she?
7. The engine not producing any power now.
8. We studying the main components of a motor vehicle.

**X. Translate the sentences into English using your active vocabulary.**

1. Что он сейчас делает? — Он изучает панель приборов в автомобиле.
2. Какие приборы находятся на этой панели? — Спидометр, тахометр, амперметр и другие — Понятно.
3. - А что делают Петр и Анна? - Они наблюдают за показаниями тахометра.
4. - Что сейчас показывает амперметр? - Он показывает +20 А.

5. Генератор переменного тока вырабатывает мощный ток для двигателя.
6. Батарея сейчас разряжается.
7. Так как двигатель сейчас вращается медленно, генератор переменного тока также вращается медленно.
8. Студенты сейчас чертят график.

## Reading and Speaking

**I.** It is impossible to live and work without a car these days. A lot of people drive a car to work or when they travel. Discuss the following questions with your partner.

1. Do you have a car?
2. Would you like to have a car in the future?
3. Do you think it's necessary to have a car?

**II.** List as many parts of a car as you can. Compare your list with that of the other groupmates.

**III.** Now read the text and then answer the questions given after it.

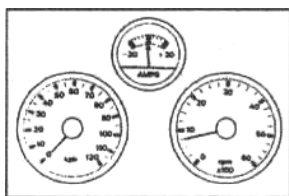

Fig. 1

Look at the picture. There are some instruments for the car panel there. In fig. 1 the speedometer is indicating zero kph<sup>1</sup>. The car is not moving. The engine is turning at minimum speed (approximately 750 rpm<sup>2</sup>).

As the engine is turning slowly the alternator is also turning slowly. It is not producing enough current for the engine. The battery is discharging and so the ammeter is indicating about -5A<sup>3</sup>.

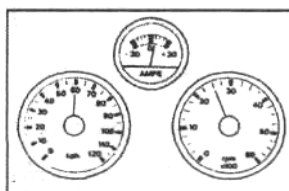

Fig. 2

Look at fig.2. The car is now moving at 60 kph. The engine is turning at 2500 rpm and so the alternator is turning quite fast. It is producing a strong current for the engine. The battery is now recharging from the alternator and so the ammeter is indicating +10A.

<sup>1</sup> км - kilometers per hour

<sup>2</sup> rpm - revolutions per minute

<sup>3</sup> A - ampere

1. Is the speedometer indicating zero kph in fig. 1?
2. The car is not moving in fig. 1, is it?
3. Why is the alternator turning slowly?
4. Is the battery charging or discharging in fig. 1?
5. What is the car doing in fig. 2?
6. The engine is turning at 2300 rpm now, isn't it?
7. Is the alternator producing a strong or a weak current for the engine in fig. 2?
8. Is the battery recharging now?

**IV. Complete the sentences using the wordlist below.**

Look at fig.3. The car ... now moving  
 ... 90 The engine is ... at the speed of  
 4500 rpm. However, the alternator ... not  
 producing any .... The ammeter ... -20 A. In other  
 words, the battery is ... rapidly, ... the engine is ... at a  
 high speed. Therefore, the ... is not producing ... power.

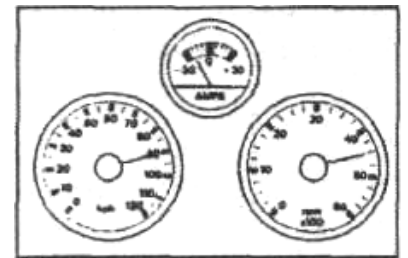

**Fig.3**

is, at, kph, current, turning, is, alternator, although, any, turning, is, indicating, discharging.

**V. You are driving a car now. Your friend is sitting next to you. He does not know anything about the car devices. Describe the work of a tachometer, a speedometer or an ammeter to him.**

**Further Reading**

**I. Look at the following list of words. They are all from the text below. Check your dictionary to find their meaning.**

graph, *n*                      evenly, *adv* axis,  
 variable, *n*                    *n* (*pl.* axes)  
 label, *v*

**What do you think the text is about?**

**II. Match the words with their definitions.**

- 1.graph      a. relative size or extent
- 2.scale      b. a diagram that shows relationship between quantities



3. label            c. to put a note on an object  
 4. variable        d. something that varies

**III. The students of the Technical University are at the practical class now. Read the text and learn how to draw graphs in the correct way.**

Graphs are very important for recording the results of any experiments. Now the students are drawing graphs in their exercise books. First, they are giving the graph a title. Then they are drawing the axes and putting the independent variable along the bottom of the graph paper (the horizontal axis). The other variable *depends on this one*<sup>1</sup> and the students are drawing it up the side of the paper (the vertical axis). It is also called the dependent variable. The origin of the graph is usually the point (0,0).

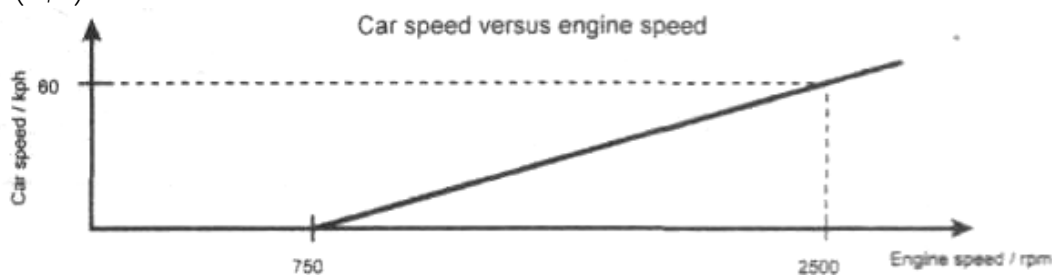

For example, if you are measuring the speed of a car when it is moving, you choose the speed of the engine and put it along the horizontal axis (rpm). In this case the speed of the car is on the vertical axis.

Now the students are choosing the scales *so that*<sup>2</sup> the graph fills most of the paper. After that they are numbering the scales evenly and labelling them (the scales) with the correct units. For example, "Speed in kph" or "Speed/kph".

<sup>1</sup>зависит от этой переменной

<sup>2</sup>так, чтобы

**IV. Study the graph in the text and answer the following questions.**

1. What is the title of the graph?
2. Is "engine speed/rpm" the independent or dependent variable?
3. What is the name of the independent variable?
4. What is the origin of the graph?

**V. Complete the sentences with the words given on page 105.**

Michael is studying how to draw graphs. He is at his class now. First, he is ... the graph a title. After that he is ... the axis and ... the independent ... along the bottom of the graph paper. It is known as

the..... Then Michael is drawing the vertical axis, or the ... variable. Finally he is ... the scales for the graph, he is ... the scales evenly and labelling them with the correct... .

dependent	giving	drawing
units	putting	horizontal axis
variable	choosing	numbering

## Activity

I. Look at the pictures below. Discuss with your fellow student what you see in the picture.



EXAMPLE:

A: Who is that man in the picture?

B: Oh, it's Mr. Kosov.

A: Is he repairing his car?

B: No, he isn't.

A- He is painting his car, isn't he?

B: No, you are wrong.

A: What is he doing there?

B: He is cleaning his car.

A: I see. Is he cleaning it in the garage or in the workshop?

B: In the garage, of course.

a) Mr. Morton is in the car.



to drive a car

to press the pedal

to look at the indications of car instruments

to watch indications of a tachometer and an ammeter

b) Children are in the classroom.

to make mathematical operations

to solve different problems

to draw different shapes and measure their areas

to measure in  $\text{cm}^2$  or in  $\text{m}^2$

II. Your friend is showing you how to draw a graph. Describe what he is doing step by step. Begin with the words:

First, he is drawing ...    Next ...  
Then ...                      After that...

## Writing

I. The car is travelling at constant speed. This graph shows the dependence of distance on time. Study this graph and describe it. Can you calculate the speed of the car in kph?

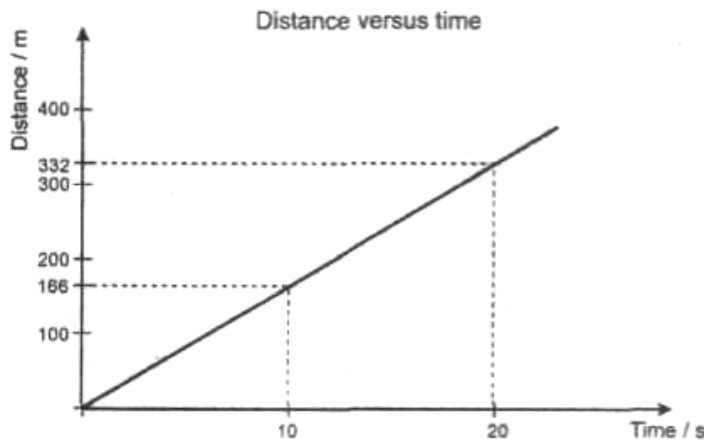

II. Translate this text into Russian. Try to carry out the same experiment at home with a TV set or radio/CD player.

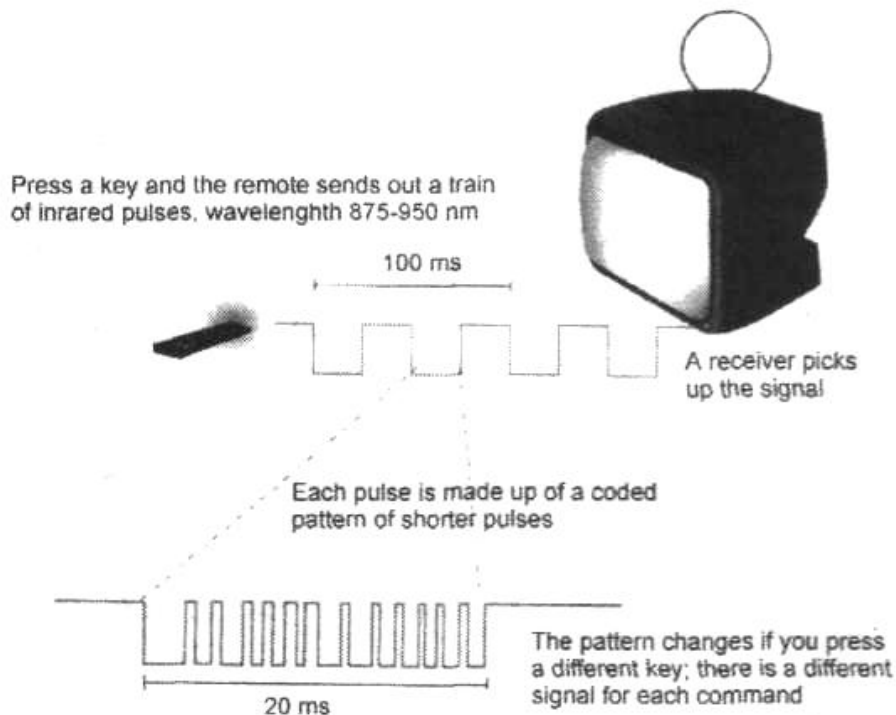

A student is experimenting with the remote control at the moment. He is putting a piece of white card about 2 cm in front of the control. The control is still operating because the beam is reflecting off the card and then the wall behind.

Now the student is using a piece of black card instead of the white card. This time the signal is not reaching the *receiver*<sup>1</sup>. Why?

Answer: the black surface *absorbs*<sup>2</sup> the *infrared rays*<sup>3</sup> and does not reflect it back into the room.

<sup>1</sup>приемник, ресивер

<sup>2</sup>поглощает

<sup>3</sup>инфракрасные лучи

## Section B. Electrical Devices

Lead-in

### I. Discuss the following questions.

a) Is it important for an engineer to know how to use electrical devices?

b) What electrical devices are there in your lab?

### A

### II. Listen to the dialogues and learn how to speak about your past and future activities. Pay attention to the terms of electricity.

*Peter:* Hi, Paul. Glad to see you.

*Paul:* So am I. Peter, can you tell me what you were doing yesterday from 9 till 11 p.m.? I was looking for you,

*Peter:* Well, let me see. A few students and I were carrying out some experiments with different electrical devices. As for me, I was measuring the voltage.

*Paul:* And what about Alex? Do you happen to know what he was doing?

*Peter:* As far as I remember, he was measuring the resistance of a lead.

*Paul:* Oh, I see. I hope Julia and Michael were helping him.

*Peter:* Yes, they were. They were connecting leads to the multimeter. The needle was indicating the value of the resistance on the scale.

**B**

*Alex:* Excuse me, Professor.

*Professor:* Yes, Alex.

*Alex:* What will you be doing from 9 till 10 tomorrow?

*Professor:* I'll probably be working in the lab. Have you got any problems?

*Alex:* Oh, yes. I'd like to discuss the plan of the experiment with you, if you don't mind.

*Professor:* Of course, I don't. When are you going to carry out the experiment with a resistor?

*Alex:* I expect in a week or two.

*Professor:* OK. I'll be waiting for you at 9 in the lab.

*Alex:* Thank you ever so much.

*Professor:* Not at all. See you tomorrow.

*Alex:* Good-bye.

**III. That's how we make predictions about the future in English. Study this table.**

MAKING PREDICTIONS ABOUT THE FUTURE

	think...	
I (don't)	expect...	I'll...
	suppose...	
	imagine...	
I'll probably ...		
I probably won't...		

**IV. Complete the dialogues using the phrases about the future from the box.**

1. *A:* ...

*B:* So am I. ...

*A:* I was carrying out an experiment in the lab.

*B:* ...

2. *A:* Where were you yesterday? I was looking for you.

*B:* ...

*A:* And what about your friend Julia? *B:* As far as I remember, ...

3. **A** ...  
**B:** Tomorrow at 7 p.m.? I'll probably be working in my office.  
 Why?  
**A** ... **B:** Of course, I don't.
4. **A:** What time are you going to be free?  
**B:** I expect...  
**A** OK. ...  
**B:** Thank you ever so much.  
**A** ... . See you tomorrow.  
**B:** ...

### V. Match a line in A with a line in B.

- |  |  |
|--|--|
| 1. Hi, Michal.   | a. I was preparing for the experiment                |
| 2. I'm glad to see you.                                | b. Yes, Anna.  |
| 3. What were you doing<br>at 9 yesterday evening?      | c. So am I.  |
| 4. Excuse me, Mr. Kosov.                               | d. Hello, Helen.                                     |
| 5. I'm going to test a new<br>device.                  | e. Don't mention it.                                 |
| 6. Thanks a lot.                                       | f. Good luck to you.                                 |
| 7. See you tomorrow.                                   | g. We'll probably be studying<br>electrical devices. |
| 8. What will you be studying<br>at the class tomorrow? | h. See you.  |

## Language Practice

### *Vocabulary*

#### I. Study the table, then do the exercises that follow.

1. The following suffixes are used to form *nouns* from *verbs*:
- tion, -sion, -ance, -ure, -er/-or
2. The following prefixes are used to the *opposite* meaning to the word:
- dis-, in- im-.

a) Make up all possible nouns of the following verbs:

resist —  
differ -  
restrict -  
press -  
depend -  
absorb —  
product

b) Give the opposite to:

decrease -  
dependent -  
different -  
charge —  
approve -  
connect —  
possible —

II. Find in **B** the word close in the meaning to the word in A

**A**

**B**

- |                 |                   |               |                  |
|-----------------|-------------------|---------------|------------------|
| 1. to carry out | a) to wear        | b) to perform | c) to move       |
| 2. to operate   | a) to investigate | b) to charge  | c) to work       |
| 3. to apply     | a) to use         | b) to choose  | c) to accelerate |
| 4. to observe   | a) to determine   | b) to watch   | c) to calculate  |
| 5. to compile   | a) to label       | b) to make    | c) to increase   |

*Grammar: Past and Future Progressive Active*

**III. Complete the sentences. Use *was / were* + one of these verbs: *writing, carrying out, drawing, measuring, determining, testing***

1. Paul was testins a new device from 11 till 12 yesterday.
2. I ... a report on the latest achievements in electricity at 7 o'clock yesterday.
3. Alex ... the current in the circuit at 5.45 yesterday.
4. Yesterday at 11.15 Helen ... graphs at the lesson.
5. The students ... the resistance of new materials from 3 till 10 yesterday.
6. The engineers ... an important experiment at 10 o'clock last Tuesday.

**IV. Your friend was looking for you yesterday at 2 p.m., but you weren't at home. Tell him what you were doing at that time.**

EXAMPLE 1: *to work in the lab / to work in the workshop*

A: Were you working in the lab from 2 till 4 o'clock yesterday?

*B*: Yes, I was. I was working in the lab at that time.  
or *B*: No, I was not. I was working in the workshop.

to observe changes in the behavior of the current / to measure the resistance of the lead;  
to perform mathematical operations / to draw different shapes;  
to study electrical devices / to watch their indications;  
to use crocodile clips / to connect two leads;

EXAMPLE 2: *to study electrical devices*

*A*: What were you doing at 2 o'clock yesterday?

*B*: I was studying electrical devices.

to connect two leads;  
to measure the value of the current;  
to turn on the function selector switch of the multimeter;  
to study the results of the test.

## **V. Give short answers to the following questions.**

EXAMPLE: - *Will you be working in the workshop in half an hour?*

- Yes, I will.

- No. I won't.

1. Will you be controlling the indications of a multimeter in half an hour?
2. Will you be testing a manometer tomorrow?
3. Will Julia be drawing shapes at 2 o'clock tomorrow?
4. Will your groupmates be experimenting with new devices at 5 tomorrow?

## **VI. Tell your fellow students what you will be doing in half an hour.**

EXAMPLE: *to study the properties of alloys*

*A*- What will you be doing in half an hour?

*B*- *B*: I'll be studying the properties of alloys.

to measure electrical units with a multimeter;  
to decrease the voltage in the electrical chain;  
to study electrical devices;  
to study the properties of conductors.

## **VII. Give the opposite of these sentences.**

1. The professor will be reporting the results of the tests at the class tomorrow.



2. My groupmates weren't increasing the voltage in the electrical chain in the lab.
3. They won't be studying any electrical instruments.
4. I was checking the battery at 5 o'clock on Thursday.

**VIII. Put all possible questions to the following statements. Consult the table.**

---

	<i>a) Alex was</i>	<i>working in the lab</i>	<i>from 5 till 7 yesterday.</i>
Was	Alex	working in the lab	from 5 till 7 yesterday?
What was	Alex	doing in the lab	from 5 till 7 yesterday?
Where was	Alex	working	from 5 till 7 yesterday?
	Who was	working in the lab	from 5 till 7 yesterday?

---

1. I was measuring the value of a resistor from 2 till 3 yesterday.
2. Olga was connecting the leads to the resistor at that moment.
3. The students were investigating superconductors at 10.30.

---

	<i>b) Alex will be</i>	<i>working in the lab</i>	<i>from 5 till 7 tomorrow.</i>
Will	Alex be	working in the lab	from 5 till 7 tomorrow?
What will	Alex be	doing in the lab	from 5 till 7 tomorrow?
Where will	Alex be	working	from 5 till 7 tomorrow?
Who will	be	working in the lab	from 5 till 7 tomorrow?

---

1. Helen will be studying the properties of copper at 4 tomorrow.
2. Paul will be observing the indications of a multimeter in the lab tomorrow.
3. We will be studying various electrical devices all the morning tomorrow.

**IX. Ask your friend about his plans for tomorrow. Pay attention to the expression 'to be going to'.**

EXAMPLE 1: *to control the lasers / to control the electrical devices*

A: Are you going to control the lasers tomorrow from 5 till 7 p.m.?

B: Yes, I am. I'm going to control them at that time.

or B: No, I'm not. I'm not going to control them, I'm going to control the electrical instruments.

to show the results of the test in the graphic form / in the mathematical form;  
to check the indications of a tachometer / of an ammeter; to connect leads in the electrical chain / to measure the resistance; to turn the switch to the current range / to the resistor range;

EXAMPLE 2: *to test voltmeter*

A: What are you going to do in two hours?

B: I am going to test the voltmeter.

to finish the laboratory work;  
to report the results of the tests;  
to operate the electrical device;  
to study the indications of a multimeter;

**X. Insert prepositions where necessary.**

1. We are writing a test tomorrow. I must prepare ... it.
2. The students are measuring electrical units ... a multimeter now.
3. Where were you at 7 yesterday evening? I was looking ... you.
4. The car is moving ... the speed of 60 kph.
5. We are carrying ... some experiments with different electrical devices at the moment.
6. will be waiting ... you ... 9 a.m. in my office.

**XI. Correct mistakes.**

1. We will be study the properties of copper from 5 till 6 tomorrow.
2. I will preparing for my test the whole day yesterday.
3. The students not were measuring the value of the current at the lesson.
4. I was drawing a graph at the class tomorrow.
5. Will be you carrying out this experiment next time?
6. My friends was finishing the laboratory work at the previous class.
7. The teacher will be not telling the students about electricity at the next lesson.

**XII. Translate the sentences into English using your active vocabulary.**

1. Вчера мы изучали электронные приборы в лаборатории с 2-х до 4-х часов дня.

2. - Что вы делали? - Мы проверяли приборы, затем измеряли сопротивление разных проводников: медных, алюминиевых, железных.

3. - Что он делал? — Он работал с мультиметром. Он использовал зажимы "крокодил" и соединял провода в цепи.

4. - Ты будешь проводить эксперимент в лаборатории через два часа? - Да, я буду проверять новое оборудование.

5. — Когда ты собираешься продемонстрировать результаты теста? - Я думаю, через два дня.

## Reading and Speaking

I. Nataly and Alice were not at home from 4 till 6 o'clock yesterday. They were at the University. Read this passage through to find the answers to these questions.

1. What were the girls doing in the lab?
2. Were they using a multimeter or a tachometer?
3. What is a multimeter used for?
4. What are the main parts of a multimeter?
5. What are the students going to do next time?

Fig.1

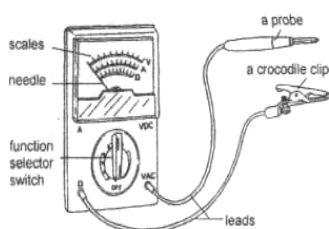

Yesterday from 4 till 6 o'clock Nataly and Alice were working in the laboratory. They were studying different electrical devices and instruments. One of them, a multimeter, was on their demonstration table all the time.

electrical units, namely:

The multimeter is used for measuring three types of

voltage, resistance and current. This device (see fig. 1) has several scales, a needle, a function selector switch, two leads, a crocodile clip and a probe.



Fig. 2

Look at picture 2 - the girls were measuring the value of the resistance at that moment. Alice was using two small crocodile clips to make a good connection between the meter and the resistor. While she was connecting the two leads to the resistor, Nataly was turning the switch to the resistance range.

The needle was indicating the value of the resistance on the ohms scale. Next time they are going to measure the current. They will be using the same multimeter.

## II. Complete the dialogue. Use the wordlist below.

- Who ... working in the lab yesterday at 11a.m.?
- Alice and Nataly ... working in the lab.
- What were they ... there?
- They were ... different electrical... .
- What device ... they working ...?
- They were ... with a ... .
- What... it used...?
- It is ... for measuring three types of electrical..., namely: ..., resist  
ance and ... .
- How were the students measuring the ... of the ... ?
- Alice was connecting two ... to the resistor ... Nataly was ... the  
... switch to the resistance ... .
- What are the students ... to do next time?  
going ... measure the ... . They'll ... using the
- Next time they same ... .

• were	value	selector	be
• are	were	devices	current
• is	turning	for	doing
• resistance	studying	voltage	while
• units	multimeter	current	with
• going	used	meter	working
• was	to	leads	range

**III. Your friend is interested in what you were doing in the lab yesterday. Describe to him how you were experimenting with a multimeter.**

## Further Reading

**I. a) When you were studying Physics at school, you learnt a lot about electricity. Do you remember any units of electricity? Can you name their English equivalents?**

**b) Study the pronunciation of the following words.**

ampere ['æmpɛə]

pascal [pa:'ska:l]

volt [vɒlt]

coulomb ['ku:ləm]

watt [wɒt]

candela ['kændila:]

joule [dʒu:l]

**II. Every day you use different electrical devices. But do you know everything about electricity? Try to answer the following questions.**

1. What is current and voltage?
2. Do voltage, current and resistance have any relationship to one another?
3. Can you name the unit of resistance, the unit of power, the unit of force?
4. What is SI?
5. What is a 'derived' unit?
6. What derived units are known to you?

### III. Now read the text to check your answers.

The amount of electricity which is flowing (it is called the current) is measured in units called amps. The pressure of electricity, the voltage, is measured in volts. A unit of resistance is called an ohm.

Current, voltage and resistance have a definite relationship to one another. The current and the voltage determine the power, the rate at which electrical energy is used. A unit of power is a watt.

In System International (SI) there are seven base units. They are the following:

- the metre (m) as the unit of length;
- the kilogram (kg) as the unit of mass;
- the second (s) as the unit of time;
- the ampere (A) as the unit of electric current;
- the kelvin (K) as the unit of (thermodynamic) temperature difference;
- the mole (mol) as the unit of substance;
- the candela (cd) as the unit of *luminous intensity*<sup>\*</sup>.

All other SI *units are derived from*<sup>2</sup> the seven base units. They are the joule, the watt, the pascal, the newton and, most interestingly, the unit of charge, the coulomb.

<sup>1</sup> сила света

<sup>2</sup> единицы, производные от

### IV. Check if you know the following SI units.

1. The unit of time is ...
2. The unit of substance is ...
3. The unit of electric current is ...
4. The unit of length is ...
5. The unit of luminous intensity is ...
6. The unit of mass is ...
7. The unit of thermodynamic is ...
8. The unit of charge is ...

## Activity

**I. Find out what the people in the pictures are going to do. These are possible questions that you can ask.**

Where is Max?

What is he doing?

What is he doing at the moment? What is he going to do next? When is he going to finish the work?

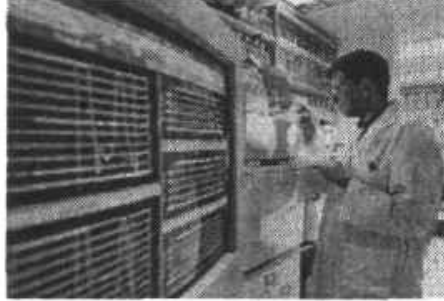
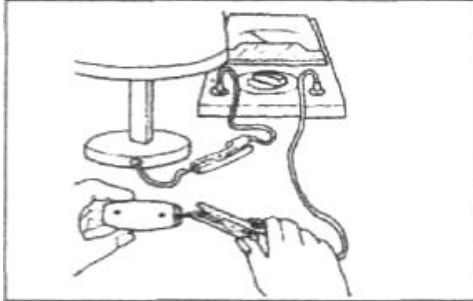

**Max is at the practical class.**

**The engineer is in the lab.**

to work with a multimeter to measure the voltage to connect the leads to watch the indications on the scale

to prepare for the experiment to study the behavior of the current to describe the results in the graphic form to carry out some tests

**II. Your boyfriend/girlfriend wanted to see you yesterday but he/she couldn't find you. Explain to your friend what you were busy with. Some phrases are already given to you.**

A: Well, my dear, can you tell me what you were doing yesterday evening?

B: Well, I was ... .

A: Were you alone in the lab, I wonder ?

B: Er, no. Actually my ... .

A: Your ...?! In what way was he/she helping you, if it's not a secret?

B: Well, ... .

A: Really? And can you tell me what you will be doing tomorrow at this time?

B: Well, let me think for a moment. I'll be ... .

A: I see. But dear

Useful expressions:

to prepare for the experiment / to carry out the experiment  
to measure the value of the current / to control voltage in the system  
to check the indications of a multimeter / to write a report

**III. Do the crossword.**

*Down:*

- 2. a unit of electromotive force, equal to ampere / ohm
- 3. a unit of work and energy, equal to newton / metre
- 4. a unit of electric current, equal to coulomb / second
- 5. a unit of power, equal to joule / second

*Across:*

- 1. a unit of electric charge, equal to ampere / second
- 6. a SI unit of pressure equal to newton / square metre

**Writing**

**I. Yesterday you were watching how some students were experimenting in the lab. Describe their activities. The words below will help you.**

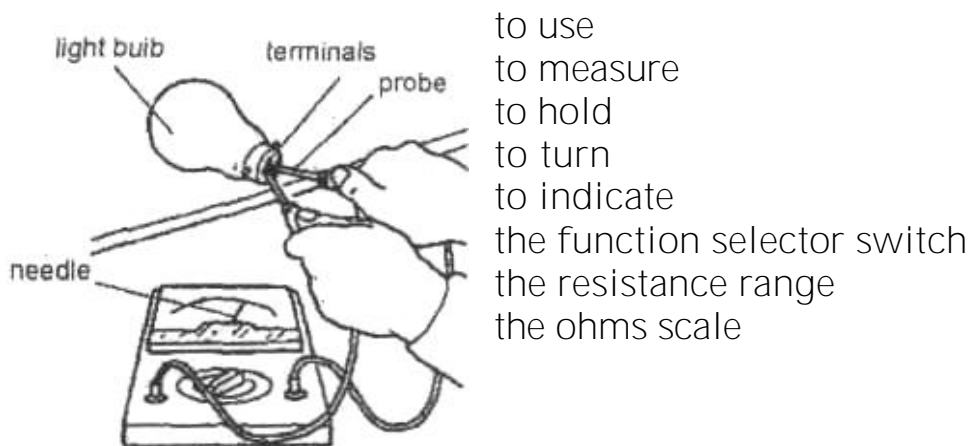

## II. Translate the text into Russian. Use the dictionary if necessary.

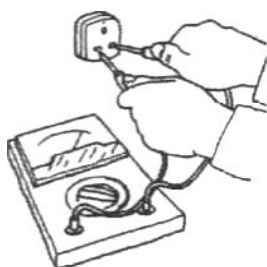

The students of the Technical University were carrying out an experiment with a multimeter in the lab last week. They were checking a mains socket in the wall and they were following all the safety instructions. Paul was using two probes that time. While he was inserting them into two terminals of the socket, his groupmate Alex was turning the function selector switch to the VAC

(voltage alternating current) range. The needle was indicating the pressure of electricity, i.e. the voltage in the mains. Everybody was watching the indications on the volts scale. It was 220 volts. Next time they are planning to measure the current in a table lamp.



## UNIT EIGHT

### COMPUTING

#### *Section A. Computers Today*

##### Lead-in

**I.** Is it possible to imagine our life without computers? How useful are they?

**II.** Alice and Paul are talking in the University coffee-bar. Listen to their conversation and name the advantages of computers.

*Alice:* Paul, what are you going to do at your laboratory classes

today? *Paul:* I'm going to work on a computer. *Alice:* And do you often work at the computer centre? *Paul:* Not very often. But I like to work on a computer. It does the

work of many human beings at fantastically high speeds. *Alice:* Well, if I'm not mistaken it's primarily a calculating

machine. *Paul:* Oh, I believe that it's almost a human machine with "brains".

A computer usually replaces people in dull, routine tasks. It

works according to the instructions. *Alice:* Well, I see. In my opinion, it's a fascinating machine. *Paul:* Exactly.

**III.** Complete the dialogues.

1. *A:*...

**B** I'm going to work on my project. What about you? *A:*...

2. *A:* Do you often work in the Internet centre? *B:*...

3. *A:* As far as I'm concerned, a computer is almost a human machine!

*B:*...

IV. Match a line in A with a line in B.

**A**

1. What is a computer?
2. Do you often work in the computer center?
3. What is a programme?
4. What basic job does a computer perform?
5. Do modern computers operate quickly?
6. What is the most popular Internet service?

**B**

- a. It's a set of instructions in a special computer language.
- b. Yes, they do.
- c. I think, e-mail.
- d. Well, it's a complex electronic machine.
- e. Not very often.
- f. It receives and processes information.

Language Practice

*Vocabulary*

I. Make up all possible nouns of the following verbs.

- to decide - to add -  
to instruct - to operate -  
to inform - to multiply -  
to divide - to subtract -  
to employ - to perform -

II. Find in **B** the word close in the meaning to the word in A.

**A**

1. to supply
2. to employ
3. to store
4. network
5. to embrace

**B**

- |               |               |                   |
|---------------|---------------|-------------------|
| a) to process | b) to give    | c) to accept      |
| a) to define  | b) to operate | c) to use         |
| a) to keep    | b) to perform | c) to carry out   |
| a) task       | b) web        | c) circuit        |
| a) to include | b) to solve   | c) to communicate |

III. a) Study the picture and learn how to name different computer components.

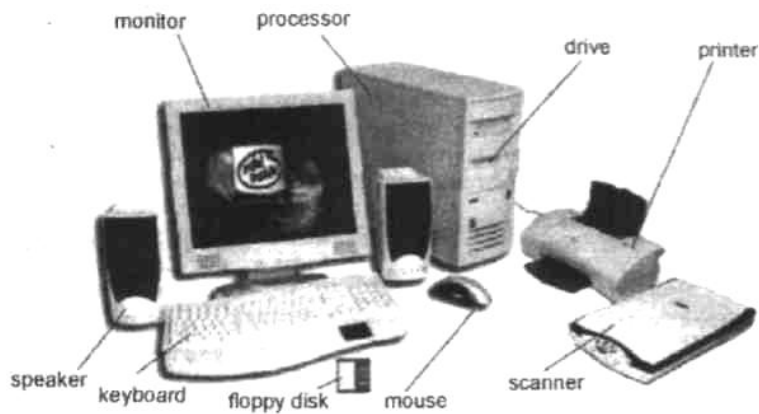

b) Ask your friend to name these computer components in English.

клавиатура      мышь  
 процессор      сканер  
 дискета        принтер  
 колонка        монитор  
 дисковод

*Grammar: Present Simple (Active)*

IV. Study this chart and make sentences about Michael and Ann, Paul and yourself.

EXAMPLE 1: a. Michael and Ann seldom leave the work half done. b. Paul always leaves the work half done, c I...

☺	How often do you ... ?	Michael and Ann	Paul	You
	1. leave the work half done	seldom	always	?
	2. employ minicomputers	frequently	sometimes	?
	3. attend classes in programming	usually	seldom	?
	4. compile programmes for a computer	often	never	?
	5. use the Internet	regularly	rarely	?
	6. work at the Internet centre	every week	once a month	?

EXAMPLE 2: 1. Michael and Ann don't test computer programmes every day. 2. Paul doesn't test computer programmes every day.

☺ What do you do every day?	Michael and Ann	Paul	You
1. test computer programmers	-	-	?
2. solve different problems	+	-	?
3. study different programming languages	+	-	?
4. perform arithmetic operations	-	+	?
5. work on a computer	—	—	?

V. Give the opposite to the following sentences.

1. A computer doesn't usually make different types of decisions.
2. A computer stores information in its "memory".
3. The new calculating machine does many kinds of calculations.
4. Modern personal computers don't perform work at high speeds.
5. The electronic machines receive and store information.

VI. Answer your partner's questions.

EXAMPLE 1: *to prepare computer programmers*

A: Do you prepare computer programmers?

B: Yes, I do. I often prepare computer programmers. or

B: No, I don't. I never prepare computer programmers.

to work at the computer centre      to solve different problems  
to perform arithmetic operations      to use floppy disks  
to print information on paper

EXAMPLE 2: a) *to carry out logical operations*

A: Does a computer usually carry out logical operations?

B: Yes, it does. A computer usually carries out logical operations.

b) *to supply new information*

A: Does a computer supply new information?

B: No, it doesn't. It doesn't supply new information

to process information  
to increase the labour force  
to present information

to do the work at high speeds to  
replace people in dull tasks

VII. Put all possible questions to the following statements.

---

*A computer processes information rapidly.*

Does a computer process information rapidly?

What does a computer process rapidly?

How does a computer process information?

What processes information rapidly?

---

1. Computers control mechanical operations in the car industry.
2. The design of computers changes quickly.
3. Technicians usually install new computers in our laboratory.
4. Computers change the conditions of our work to a great extent.

VIII. Think of some questions for the following answers. The answers needn't be true.

1. Not very often.
2. It is a calculating machine.
3. I don't think so.
4. It usually does.
5. At the computer centre.
6. Yes, it is very important nowadays.

IX. Correct mistakes in the following sentences.

1. He often work on a computer.
2. My friends doesn't learn any programming language.
3. What operations a modern computer performs?
4. Do you often employ<sup>1</sup> minicomputers? - No, we doesn't.
5. Alex have a new computer-notebook.
6. Always computers help people solve difficult tasks.

X. Translate the sentences into English using your active vocabulary.

1. **Какие операции выполняет компьютер?**
2. **Компьютер не думает, не так ли?**
3. **Компьютер выполняет многие виды расчетов быстро и точно.**
4. **Студенты технических вузов часто выполняют математические операции при помощи компьютера.**
5. **Компьютер получает, хранит и обрабатывает информацию.**

6. Мы используем разные виды компьютеров, не так ли?
7. Компьютеры состоят из программного и аппаратного обеспечения.
8. Компьютерная сеть Интернет охватывает миллионы пользователей.

## Reading and Speaking

I. A lot of people have a computer nowadays. What do you know about computers? What basic jobs does a computer perform?

II. List as many computer components as you can. Compare your list with that of your group mates.

III. Match the component with the function. Look through the text to check your answers.

### A component

### A function

1. Storage device

a. It displays the processed data.

2. Output device

b. It holds the programmers and data, which the processor uses.

3. Main memory

processing and controls the

c. It does all the peripherals.

4. Processor

d. It provides permanent storage.

5. Input device

e. It enters data.

IV. Read the text attentively and find the answers to the following questions.

1. What are computers?

2. What operations do computers perform?

3. A computer doesn't think, does it?

4. Is a computer a simple electronic machine? Why / why not? Computers are electronic machines. They communicate with the

user, perform different kinds of arithmetic operations, such as addition, subtraction, division and multiplication, solve a series of logical problems and make thousands of logical decisions. Modern computers operate quickly and accurately. However, they don't think.

Every computer consists of software and hardware. Information in the form of programmers and data is called software, but the pieces of equipment that make up the computer system are known as hardware.

The most important item of hardware is the CPU (Central Processing Unit). This is the electronic unit at the centre of the computer system. The brain of the computer is the processor. It does all the processing and controls all the devices in the computer system. The main memory stores all the programmes and data used by the processor.

All the other devices in the computer system are known as peripherals. These include input devices, output devices and storage devices. An input device supplies information into the computer. The most commonly used input device is a keyboard. An output device such as a monitor or a printer displays the processed data. A storage device is used for the permanent storage of information on floppy discs or CD-ROM discs.

V. Cross out the odd word.

- a) processor, main memory, software
- b) input device, data, storage device
- c) monitor, floppy disc, printer
- d) hardware, programme, data

VI. Fill in the missing information in this diagram.

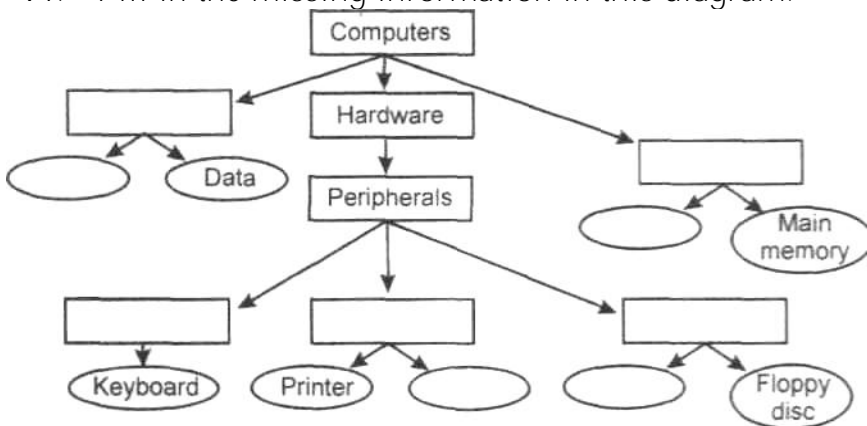

VII. This is a summary of the lecture on computers that was taken from a student's notebook. But the teacher was speaking too fast and the student couldn't follow him. Help him restore the necessary information.

Computers are complex electronic machines. They perform arithmetic ... such as ... and make thousands of logical ... All modern computers ... quickly and ...

Computers consist of software and ... Software includes ... and data. Hardware contains the central ... Unit and the peripherals.

The processor is the ... of the computer. It ... all the processing. The ... memory ... all the programmes and data used by the ...

An input device ... information into the ...

An output device ... the processed data.

A ... device is used for the ... storage of information.

VIII. One of you is a teacher of Computer Science. The other is a student. The student is taking a test on computer components and functions. The teacher is asking questions and checking if everything is correct. Reproduce this conversation. Work in pairs.

Useful phrases:

What is this device called? What is its function? Try again.	Excellent! Well done! If I'm not mistaken, .. As far as I know, ...
--	---

Further Reading

I. Before reading the text answer the following questions.

1. How many people use the Internet these days?
2. What popular Internet services do you know?
3. Do you often use the Internet? What for?

II. Now read the text about the Internet service.

The Internet

The Internet is a global computer network that embraces millions of users all over the world. It dates back to 1969 when it *began*<sup>1</sup> as a military experiment. Information that people send over the Internet



takes the shortest path available from one computer to another. Because of this, any two computers on the Internet stay in touch with each other as long as there is a single route between them. This technology is called *packet switching network*<sup>2</sup>. Owing to this technology, if some computers on the network fail, the information just routes around them.

One of the most popular Internet services is e-mail. Most of the people, who have access to the Internet, use the network only for sending and receiving e-mail messages. However, other popular services are available on the Internet: reading USENET News, using the World-Wide Web and Intranet.

However, some problems remain. The most important is security. When you send an e-mail message to somebody, this message travels through many different networks and computers. Special computers that are called *routers*<sup>3</sup> direct the data towards its destination. That is why it becomes possible to get into any of computers along the route and even change the data that we send over the Internet. This happens because the Internet transmits nearly all the information, which we send without any form of encoding.

---

<sup>1</sup>Начался

<sup>2</sup>сеть коммутации пакетов

<sup>3</sup>маршрутизаторы

III. Say whether the following sentences are true or false. Correct the false sentences.

1. Only one million people use the Internet.
2. The most popular Internet service is e-mail.
3. People use the Internet only for sending and receiving e-mail messages.
4. It is impossible to get into any of computers along the route.
5. There is a special form of encoding with the help of which the Internet transmits nearly all the information.

IV. Read the translation of the 1st paragraph. Compare it with the original and say if everything is right.

**Глобальная компьютерная сеть Интернет включает миллионы пользователей во всем мире. Информация, которую отправляют по Интернету, проходит самый короткий путь от одного компьютера к другому. По этой причине, любые два компьютера в сети Интернет связаны друг с другом до тех пор, пока они находятся в локальной сети.**

## Activity

I. Mr Brains is an excellent specialist in computer technology. Read the following sentences about him and say if they are true to you. Pay attention to the ways of expressing surprise.

EXAMPLE 1: *A:* He compiles programmers for a computer.  
*B:* Does he? *So do I.* I compile them, too.

EXAMPLE 2: *A:* He doesn't do millions of calculations per second. *B:* Doesn't he?  
*Neither do I. / Nor do I. / I do not, either.*

1. He prepares complicated programmers.
2. He doesn't obtain negative results in his research.
3. He has a logical mind.
4. He doesn't have access to the Internet.
5. He understands the basic concepts in computer science.
6. He doesn't study a new programming language.

II. More and more people use computers in their work. It is impossible to imagine our life without this invention of the 20th century. Are computers the greatest or the most dangerous invention? Do you use computers in your studies or do you play computer games?

a) Read the following arguments. Add of your own ones.

<i>Computers are the greatest invention</i>	<i>Computers are the most dangerous invention</i>
1. They save a lot of time.	1. They are dangerous for your health.
2. They help you to process information.	2. Some people live in the virtual reality not in the real world.
3. They operate quickly and solve problems accurately.	3. They are machines and it's easy to break them.
4. They replace people in dull and boring tasks.	4. They don't think.
5. ...	5. ...

b) Discuss the problem in groups of 3-5 students in order to make a decision.

## Writing

I. Write two paragraphs, one about the advantages and the other about the disadvantages of computers.

II. Translate the text into Russian.

Computer is a complex electronic machine. Its basic job is the processing of information. For this reason, computers are known as devices, which accept 2 kinds of information in the form of instructions. The former is called programmers and the latter is known as data.

A modern computer today performs millions of logical operations and it doesn't get tired. Sometimes it seems that a computer operates like a mechanical "brain". However, it cannot do anything *unless*<sup>1</sup> a person tells it what to do and gives it the *appropriate*<sup>2</sup> information. Computers replace people in dull, routine tasks, but they will not replace human beings in every sphere of life. *Though*<sup>3</sup> nowadays scientists are trying to devise the "Intelligent Computer".

<sup>1</sup>пока ... не

<sup>2</sup>Необходимый

<sup>3</sup>хотя

## Section **B**. From the History of Computers

### Lead-in

I. Discuss these questions.

a) How many calculating devices can you name? What were the first calculating devices?

b) When and where did the first computer appear?

II. Alice and Dima are studying in different groups. Now they are discussing their laboratory classes. Listen to their conversations and say what they are talking about.

- A. *Alice:* What did you do at your laboratory classes yesterday?  
*Dima:* I observed a very interesting experiment with superconductors. And what about you?  
*Alice:* As for me, I made a new programme for the microcomputer.  
*Dima:* Well, two years ago computer systems interested me, too. Yesterday I read a very interesting book on the history of computers by Norma D. Miller. Did you read it?  
*Alice:* I don't think I did. What does it deal with?  
*Dima:* It deals with many remarkable powers of computers and their basic capabilities.
- B. *Alice:* What will you do at your laboratory classes tomorrow?  
*Dima:* I expect I'll study changes in the properties of substances under different conditions.  
*Alice:* You will use superconductors, won't you?  
*Dima:* Yes, I will. And what are you going to do?  
*Alice:* I think I'll study commercial applications of minicomputers.  
*Dima:* You are interested in computer systems, aren't you?  
*Alice:* Yes, I am.  
*Dima:* Will you explain some computer concepts to me then?  
*Alice:* Certainly.

II. Complete the dialogues.

1. *A:* What did you do at your lab class on Monday?  
*B:* ... . And what about you?  
*A:* Well, ... .
2. *A:* ... |  
*B:* It deals with powers of computers and their basic capabilities. *A:* ...
3. *A:* ...  
*B:* I expect I will do some experiments with new substances.  
 And what are you going to do? *A:* ... *B:* .., **A Yes, I am.**

III. Match a line in A with a line in B.

- | A                              | B                            |
|--------------------------------|------------------------------|
| 1. What are you interested in? | a. Certainly, with pleasure! |
| 2. What did he do yesterday?   | b. Long time ago.            |

3. Will you study the commercial applications of minicomputers at your lab class tomorrow?
4. Will you explain some computer concepts to me, please?
5. When did you begin to study computer science?
- c I'm interested in computer systems.
- d. He made a new programme for a microcomputer.
- e. I expect so.

Language Practice

*Vocabulary*

I. Complete the list of derivatives. Use your dictionary if necessary.

<i>Verb</i>	<i>Noun</i>	<i>Adjective</i>
1.	1. invention	1.
2. calculate	2.	2.
3.	3.	3. devisable
4.	4. production	4.
5.	5.	5. independent
6.	6. experiment	6.
7.	7.	7. reduced/ reducible
8 compute	8.	8.

II. Find in **B** the correct translation to the word in A.

<b>A</b>	<b>B</b>		
1. изобретать	a) to reduce	b) to invent	c) to employ
2. считать	a) to count	b) to operate	c) to communicate
3. продолжать	a) to produce	b) to embrace	c) to go on
4. разрабаты- вать	a) to work	b) to devise	c) to divide
5. много	a) a great deal of	b) a few	c) several
6. зависеть	a) to reduce	b) to define	c) to depend
7. счёты	a) counter	b) abacus	c) device

III. Match the words from both columns to make all possible word combinations.

- |                |                |
|----------------|----------------|
| 1. calculating | a. network     |
| 2. wide        | b. tables      |
| 3. easy        | d. mathematics |
| 4. logarithm   | e. device      |
| 5. branch of   | e. disc        |
| 6. global      | f. way         |
| 7. floppy      | g. application |

Grammar: Past, Future Simple Active

IV. Give the Past Simple of the following verbs. Pay attention to irregular verbs. See Appendix 4, p. 281.

- |            |               |            |
|------------|---------------|------------|
| to break   | to understand | to change  |
| to compile | to express    | to be      |
| to try     | to break      | to give    |
| to read    | to perform    | to process |
| to think   | to take       | to drive   |
| to find    | to write      | to know    |

V. Use one of the given verbs below to fill each gap. Put the verb in the Past Simple.

test read understand study solve ~~compile~~

1. Andrew *compiled* a new programme yesterday.
2. I ... a book on the history of computers a week ago.
3. The students ... a calculating machine at the laboratory class last month.
4. All the students ... the basic concepts in computer science.
5. Julia ... a complicated problem at the lesson of Mathematics.
6. We ... scientific application of computers last week.

VI. Make the following sentences negative.

EXAMPLE: *Computers reduced manpower.*

Computers didn't reduce manpower.

1. The computer processed a lot of information.
2. First computers solved problems slower than a human being.
3. A computer changed my lifestyle to a great extent.
4. Mechanical devices increased lab our productivity in industry.
5. The new computer stored data with high accuracy.

VII. Tell your friend when you did these things.

EXAMPLE: *to work on a computer*

A: When did you work on a computer?

B: I worked on a computer in the computer centre yesterday.

to study different kinds of computers	<i>yesterday</i>
to calculate complex mathematical equations	<i>last week (month)</i>
to study the advantages of minicomputers	<i>two days ago</i>
to prepare complicated programmers	<i>the day before yesterday</i>

VIII. Put all possible questions to the following statements.

*First-generation computers came out in the USA in the 1950s.*

Did first-generation computers come out in the USA in the 1950s?

When did first-generation computers come out in the USA?

Where did first-generation computers come out in the 1950s?

What came out in the USA in the 1950s?

1. Engineers designed computers for particular purposes.
2. My group mate studied the application of minicomputers last term.
3. The book on the history of computers dealt with basic capabilities of computers.
4. Computers changed the condition of our work and life to a great extent.

IX. Choose the correct verb form.

1. The engineers discussed / were discussing new computer technology at 4 o'clock yesterday.
2. He explained / was explaining basic computer terms to us two days ago.
3. I was testing / tested a new device when you called me.
4. I was writing down / wrote down the results of the experiment from 9 to 10 a.m yesterday.
5. Helen learned / was learning two computer languages when she was studying at University.

X. You are discussing computers of the future with your group mates. Say what the computers will look like.

A computer of the future	will perform	operations faster.
	will not (won't) be	very big.

- to process data at higher speeds
- to change the conditions of our work to a great extent
- to differ from the computers in use today
- to use tiny integrated circuits
- to resemble a human being
- to replace a person in every sphere of life

XI. Your friend studies computer science. Ask your friend when he will do these things.

EXAMPLE: *to work on a microcomputer*

A: When will you work on a microcomputer?

B: I will work on a microcomputer tomorrow.

- to study the capabilities and limitations of a new computer *tomorrow*
- to discuss advantages and disadvantages of a PC *in a day (three days)*
- to study the minicomputer technology *the day after tomorrow*
- to check the main components of a computer *next Monday (week, month)*

XII. Put all possible questions to the following statements.

---

		<i>They</i>	<i>will discuss</i>	<i>experimental</i>	<i>data</i>	<i>in a week.</i>
Will	they	discuss	experimental	data	in a week?	
What	will	they	discuss		in a week?	
When	will	they	discuss	experimental	data?	
	Who	will	discuss	experimental	data	in a week?

---

1. Our industry will introduce complex robots with minicomputers into production in the future.
2. Computers will find wide applications in different branches of engineering soon.
3. The students will compile new programmes in a month.
4. We will discuss all advantages and disadvantages of the Internet at tomorrow's conference.



XIII. Insert the necessary prepositions.

1. Students at the Technical University often carry ... different experiments.
2. Although Ivan gets very tired he always goes ... working.
3. A lot depends ... computers today.
4. Minicomputers save a great deal .... time.
5. All the students of our University have access ... the Internet.
6. This new device will find wide application ... many branches of industry.

XIV. Correct mistakes.

1. I studied the capabilities of a new computer tomorrow.
2. First-generation computers will come out in 1950.
3. During the 18th century many people try to find easy ways of calculating.
4. The first calculating machine don't perform operations at high speeds.
5. Modern computers will to save a great deal of time.
6. Henry Briggs didn't invented calculus.
7. Soon a new generation of computers will appears.
8. Third-generation computers did appear in 1965.

XV. Translate the sentences into English using your active vocabulary.

1. Через несколько лет компьютеры станут меньше и более мощными.
2. Эти роботы будут использовать микрокомпьютеры.
3. Первые вычислительные машины появились в 1920г.
4. Вы сравнили возможности двух видов компьютеров?
5. Они сделают программу для компьютера через неделю?
6. Наш профессор разработал новое устройство для вычислений.
7. Новое поколение компьютеров будет выполнять миллиард операций в секунду.
8. Компьютеры второго поколения выполняли работу в 10 раз быстрее, чем компьютеры первого поколения.

Reading and Speaking

I. Learn to read these words properly. Do you know their Russian equivalents? If not, consult the dictionary.

abacus ['æbəkəs]  
bead [bi:d]  
logarithm ['lɑgəriðəm]

gear [giə]  
binary ['bainəri]

II. Before reading the text try to answer the following questions.

1. What was the 1st calculating device?
2. What is the abacus? Do people still use it nowadays?
3. Who invented calculus?
4. When did the 1st real calculating machine appear?
5. What is Charles Babbage famous for?

III. Now read the text about the history of computer systems and check your answers.

### History of Computer Systems

The very first calculating device was the ten fingers of a man's hand. This, in fact, is why today we still count in tens and multiples of tens. Then people invented the abacus, a bead frame in which the beads move from left to right. People went on using some form of abacus well into the 16th century, and it is used in some parts of the world because it's not necessary to know how to read in order to use it.

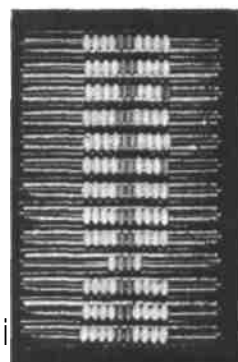

During the 17th and 18th centuries people tried to find easy ways of calculating. The French scientist Blaise Pascal invented the first adding machine in 1642. His machine was mechanical in nature and it used gears to store numbers. John Napier, a Scotsman, devised a mechanical way of multiplying and dividing. He also produced the first logarithms. All mathematicians today use logarithm tables. Leibnitz, a German mathematician, developed a the binary system of mathematics in the 1600s. Binary mathematics uses only the 0 and the 1, and arranges them to represent all numbers.

The first real calculating machine appeared in 1820 as the result of several people's experiments. This type of machine, which saved a great deal of time and reduced the possibility of mistakes, depended on a series of *gear wheels*<sup>1</sup> and used "punched cards". In 1830 Charles



Babbage, an Englishman, began to design a machine that was later called the "Analytical Engine"<sup>2</sup>. Babbage showed this machine at the Paris Exhibition in 1855. It contained all of the basic elements of an automatic computer - storage, working memory and input device. Many of his ideas were the basis for building today's computers.

<sup>1</sup>зубчатые колеса

<sup>2</sup>Аналитическая машина

IV. Arrange the following calculating devices according to the time of their invention.

the first adding machine    the "Analytical Engine"    the abacus  
the first multiplying    the modern calculator    the computer  
and dividing device

V. Match these people with the country of their origin. Say what you know about each of them.

- |                     |             |
|---------------------|-------------|
| 1. John Napier      | a) England  |
| 2. Charles Babbage  | b) Germany  |
| 3. Wilhelm Leibnitz | c) France   |
| 4. Blaise Pascal    | d) Scotland |

VI. How are the following ideas expressed in the text?

1. Then people created the abacus.
2. People continued to use some form of abacus well into the 16th century.
3. J. Napier invented a mechanical way of multiplying and dividing.
4. This machine saves a lot of time.
5. This type of machine is based on a series of gear wheels.

VII. Work in pairs. In the Technical University tomorrow there will be an exhibition "A long way to computers".

*Student A:* The Dean of your Department has asked you to be a guide at this exhibition and describe to the visitors all the calculating devices displayed. Ask a specialist on computer history to find out as much information as possible about these devices. They are:

*a picture of a man's two hands, an abacus, logarithm tables, the first adding machine, the Analytical Engine.*

*Student B:* You are a specialist on computer history. Answer the guide's questions about different calculating devices.

You may start like this:

*Student A:* Dear Mr Kosov, I would like to ask you several questions about some calculating devices.

*Student B:* Yes, what devices are you interested in?

*A:* Well, what was the very first calculating device?

*B:* ...

*A:* ...

## Further Reading

I. Are you good at computers? Try to answer the following questions to check your knowledge. Is there anybody in your group who knows all the answers?

1. When did the first generation of computers appear?

2. The first-generation computers used vacuum tubes, didn't they?

3. What did the second-generation computers use instead of vacuum tubes?

4. How did the computers of the third generation differ from those of the first and the second generations?

5. Do we have computers that complete millions of operations per second?

6. What was the first PC called?

II. Read the text and check your answers.

Let's have a look at the history of computers. The first general-purpose electronic digital computer came out in the USA in 1946. It was called ENIAC (Electronic Numerical Integrator And Computer). ENIAC contained about 18,000 vacuum tubes, weighed more than 30 tons, occupied more than 1,500 square feet of floor space, and consumed 150 kilowatts of electricity during operation. The first-generation computer performed about 5,000 additions and 1,000 multiplications per second and was slow in comparison with modern machines. In the late 1950s the second generation of computers appeared and these performed work ten times faster than the first computers. The reason for this extra speed was the use of transistors instead of vacuum tubes. The third-generation computers appeared in 1965. They performed a million calculations per second, which was 1000 times as many as first-generation computers. Now tiny integrated circuits controlled computers.

By the late 1960s many large businesses depended on computers. Many companies linked their computers into networks and that made

it possible for different offices to share information. During this time computer technology improved rapidly. In the 1970s there appeared a microprocessor. And in 1975 American engineers devised the first personal computer, Altair. Millions of individuals, families and schools began to use PCs.

Present-day computers complete millions of instructions per second. Some experts predict that a new generation of intelligent machines will process data with the help of beams of laser light, rather than electric current. They say that these computers will store data on individual molecules and that virtual reality will play a large role in education.

III. Complete the sentences.

1. First-... computers ... 5,000 ... and 1,000 ... . 2. The ...-generation ... performed ... ten times faster than the ... -generation .... 3. Second-generation computers used ... instead of ... 4. Many companies ... their computers into .... 5. Future computers ... probably ... data with the help of ... of laser light. 6. Some experts predict that will... a large role in education.

IV. Expand these sentences with the information from the text

1. First-generation computers were slow.
2. Second-generation computers used transistors.
3. There were many improvements in the third generation of computers.
4. People became dependent on computers.
5. Computers of the future will be better.

V. Give a title to the text.

## Activity

I. Play a guessing game.

*Student A:* Choose one of the calculating devices given below.

Student **B** will have to guess what device it is. Answer his questions (no more than five!).

*the Analytical Engine, the abacus, the ENIAC*

*the calculator, the Altair, the modern computer*

*Student B:* Ask no more than five general questions to guess what calculating device Student A has chosen.

II. You and your friend are preparing for an exam in Computer Studies. Ask each other different questions to check your knowledge of the subject.

These are possible questions:

1. When and where did the first calculating machine appear?
2. What calculating machines do you know?
3. What is ENIAC?
4. ...

## Writing

I. Describe the computer you would like to have in the future.

II. Do you know what computers of the future will look like? Translate the text into Russian to find it out.

### Computers of the Future

In the 1980s some scientists predicted: "By the year 2000 we will have a network planet. In offices, shops, factories and homes there will be small machines that will help us communicate with distant computers. We will ask them questions, perform calculations and enter data that computers will store, process and act upon. Probably all the professions will have their own data banks. People will use home terminals for education, planning vocation and sheer entertainment. They will buy theatre tickets, airline tickets, and manage their bank accounts with the help of Internet".

All this is reality nowadays. But the potential uses of computers are still endless. Today scientists predict that we will have machines that are as intelligent as we are. Here are some of their predictions:

- cars will report good and safe driving;
- a TV set will choose programmes that the viewer enjoys. Better yet, it will not repeat annoying commercials;
- a house will sense the mood of its owner: the coffee machine will kick in (=start working) when it's needed.

## UNIT NINE

### ROBOTICS

#### *Section A. Robots Components*

Lead-in

I. Discuss these questions.

a) Can you imagine the present life without robots?

b) What is a robot? Do we depend on robots a lot today? Give your reasons.

II. Peter worked at the Motor Plant. He hasn't seen his friend Nick for a long time. Listen to their dialogue and say what operations robots perform.

*Peter* Hello, Nick.

*Nick*: Hello, Peter. I haven't seen you for ages. Where have you been?

*Peter*: I have been to the Motor Plant. I've studied the industrial applications of robots there.

*Nick*: You have learned a lot of interesting things, haven't you?

*Peter*: Oh, definitely. I have seen various types of robots in operation.

*Nick*: Have you? And what operations do they perform?

*Peter*: Well, they pick up and place different objects, carry the objects from one place to another, in short they replace men in all kinds of jobs.

*Nick*: Have you got any useful experience for your future career?

*Peter*: Sure, and I'm going to make a diploma project on industrial-robots.

*Nick*: I see. Well, good luck to you then.

*Peter*: Thanks.

III. Complete the dialogues.

- a) **B:** I've been to Steel Works.  
 b) **A** ...  
**B:** Yes, I have.  
**A:** What operations do robots perform?  
**B:** ...  
**A** ...  
**B:** Certainly, I have. And I would like to carry out research on industrial robots.  
**A-** ...  
**B:** Thanks a lot.

IV. Match a line in A with a line in B.

**A**

1. Where have you been?
2. What has Alex done?
3. What has the engineer devised?
4. What is a robot?
5. What is a manipulator?
6. Have you studied industrial applications of robots?

**B**

- a. It's a special device that does the mechanical work and resembles a human arm.
- b. Yes, I have.
- c It's a machine that performs certain tasks.
- d. A new type of a robot.
- e. I've been to the plant.
- f. He has just finished his work.

Language Practice

### Vocabulary

I. Here are some suffixes to make an adjective. Translate them into Russian.

1. Verb + -able, -ible

reproduce (*воспроизводить*)    reproducible (*то, что можно воспроизвести, воспроизводимый*)

programme (...)	programmable (...)
read (...)	readable (...)
repair (...)	repairable (...)
interchange (...)	interchangeable (...)
break (...)	breakable (...)



2. Verb + -ant, -ent	
differ ( <i>различаться</i> )	different ( <i>различный</i> )
depend (...)	dependent (...)
insist (...)	insistent (...)
resist (...)	resistant (...)
signify (...)	significant (...)

3. Noun + -al	
centre ( <i>центр</i> )	central ( <i>центральный</i> )
culture (...)	cultural (...)
mechanic (...)	mechanical (...)
technology (...)	technological (...)
magic (...)	magical (...)
globe (...)	global (...)

II. What is special about the nouns and verbs of the following words?

bend spring change advance finish cause start

III. Match the words with the opposite meaning.

1. increase	a. rest
2. bend	b. start
3. motion	c. shorten
4. switch on	d. disadvantage
5. finish	e. straighten
6. advantage	f. reduce
7. widen	g. switch off

IV. Find in **B** the correct translation of the word in **A**.

<b>A</b>	<b>B</b>		
1. улучшение	a) advantage	b) advance	c) spring
2. важный	a) capable	b) available	c) essential
3. пружина	a) spring	b) capacity	c) actuator
4. даже	a) although	b) even	c) recently
5. растягивать	a) to straighten	b) to extend	c) to cause
6. приводить в действие	a) to manipulate	b) to switch on	c) to actuate

### Grammar: Present Perfect (Active)

V. Give Participle II of the following verbs.

go      become      bring  
lear      put      throw

apply	study	cut
know	choose	build
make	pay	invent
begin	drive	find

VI. Say what these people have done.

EXAMPLE: Professor Frolov works at Technical University. *invent j a new calculating method / recently* He has invented a calculating method recently.

1. Andrew is a student of Robot Engineering, study / robot components / recently
2. Helen is at the laboratory class.  
carry out / an experiment with a robot / just
3. Professor Kosov is a famous engineer, develop / a new design of a robot / lately
4. Paul is checking robot components, check / the robot programme / already
5. The student is in the Demonstration Hall now. observe / the robot in operation / just

VII. Give the opposite to the following sentences.

1. Scientists haven't made any important developments in technology over the last 10 years.
2. The Professor has described achievements in robotics to his students. -
3. I have never been to the Museum of Technology in Amsterdam.
4. He has already studied robot history.
5. The laboratory has recently received a new model of a robot.

VIII. Ask your fellow student if he has already done these things.

EXAMPLE: *to make a discovery - yet*

A: Have you made a discovery yet?

B: Yes, I (we, they) have. I (we, they) have already made a discovery. or

B: No, I (we, they) haven't. I (we, they) haven't made a discovery yet.

to learn interesting facts about robots	<i>yet</i>
to develop a new technology	<i>just</i>
to design a modern robot	<i>recently</i>
to invent a new robot component	<i>yet</i>
to learn about robot's abilities	<i>this week</i>

IX. Put all possible questions to the following statements. Consult the table.

		<i>They have just tested the new equipment in the lab.</i>				
	Have	they	just	tested	the new equipment	in the lab?
What	have	they	just	tested		in the lab?
Where	have	they	just	tested	the new equipment?	
What equipment	have	they	just	tested		in the lab?
		<i>Who has just tested the new equipment in the lab?</i>				

1. The operator has already changed the direction of the robot manipulator.
2. She has become famous for her invention.
3. We have studied the robot's application at the class today.
4. Our engineers have just completed the description of the system in operation.

X. Make up some questions for the following answers. The answers needn't be true.

1. Yes, I have.
2. I've been to London.
3. I've observed the new industrial robot.
4. Unfortunately, not yet.
5. I've seen him recently.
6. He has already finished the experiment.

XI. Put for or *since* into each gap.

*For a week ( 7 days )*

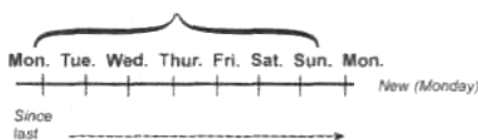

*Monday*

1. I haven't seen Paul ... January.
2. He has worked for this company ... 2 years.
3. The students have studied the robot's application ... a month.
4. Alex has been at the laboratory class ... this morning.
5. We have known about this achievement... a long time.
6. A group of students has worked on this project... the beginning of the term.

XII. Choose the correct verb form.

1. A group of engineers has applied / applied the new technology recently.
2. Our teacher described / has described the manipulator at the lesson yesterday.
3. When did you change / have you changed the robot programme? 4.1 have never tested / never tested the new equipment.
5. Did you ever study / Have you ever studied the robot history?
6. Andrew has changed / changed the robot application two days ago.

XIII. Insert the necessary prepositions.

1. I often go ... the Museum of Science.
2. I've learned a lot... engineering history.
3. The principles of robot technology stretch ... thousands of years.
4. There are numerous advances ... the field of robot technology.
5. Only ... the 1950s engineers managed to build the first generation of computers.
6. Modern robots are capable ... many life-like actions.

XIV. Correct mistakes.

1. The design and materials for robots has changed over the years.
2. Professor Levashov developed new moving devices lately.
3. I know Dr. Kosov from the Department of Mechanical Engineering since 1999.
4. Did you have carried out your research work yet?
5. Where you have been? I worried about you. 6. Michal not has checked the programme.

XV. Translate the sentences into English using your active vocabulary.

1. **Недавно белорусские ученые изобрели новую технологию.**
2. **Им стали известны некоторые интересные факты из истории роботов.**
3. **Они только что продемонстрировали возможности робота.**
4. **Она в лаборатории с 9 часов.**
5. **Он стал известным благодаря своему изобретению.**
6. **Мы еще не создали новый привод.**
7. **Студенты уже изменили программу робота.**
8. **Они уже установили манипулятор в новый робот.**

## Reading and Speaking

I. The 20th century has produced many important achievements in science and technology. Robots are one of them. In groups list as many spheres of robot application as possible. Compare your list with those of other groups.

II. These words are from the text below. Consult your dictionary to check their meaning.

Cog ,*n*                      touch ,*n*  
throughout, *adv*      appearance, *n*  
sophisticated, *adj*

What do you think the text is about?

III. Read this text attentively and learn some facts from robot history.

Although the development of robots seems a very modern idea, the principles behind this new technology were known thousands of years ago. Even ancient Greeks and Romans used mechanical cogs and gears which are now an essential part of robot technology. In the Middle Ages there was a real breakthrough in the development of robot engineering. At that time many types of mechanical devices appeared. At the end of the 17th century engineers already knew about most of the mechanical components that make up a modern robot.

Throughout history inventors have produced a variety of seemingly magical mechanical devices capable of quite life-like actions. These devices were not programmable, they were simply performing a set of operations. Different scientists and engineers have applied many advances in this field since that time.

Today's robot is a very complex structure. A metal or plastic frame serves for a skeleton, and a variety of actuators provide muscle power. But the new humanoids are not just bodies, they are also sophisticated sensing machines with cameras, microphones, even specific sensors that imitate the sense of touch. And then there are the brains. Nowadays scientists haven't yet created such a robot that can think. But who knows, maybe in the future it will not only resemble a human being in appearance but will also have the capacity to think and feel.

IV. Answer the questions.

1. When did people learn the main principles of robot technology?
2. Did ancient Greeks and Romans know anything about robots?
3. When did engineers learn about most of the mechanical components of a robot?
4. Is today's robot a simple structure?
5. Would you like to have a robot friend?

V. Complete the sentences.

1. Today the students ... some facts about ... history. 2. Ancient Greeks and Romans used ... cogs and gears which are now an ... part of... 3. At the end of the 17th century engineers already knew about most of the ... that ... a modern robot. 4. Throughout history ... have ... a variety of seemingly magical ... devices. 5. These devices were simply ... a ... of operations. 7. A robot consists of a metal or plastic ... and a variety of ... provide muscle ... 8. Today's robots are sophisticated ... machines that have ..., microphones and specific ... that imitate the ... of ... .

VI. Expand these sentences with the facts from the text.

1. The basic principles of robot technology were known thousands of years ago.
2. The Middle Ages produced advances in robot technology.
3. There were many mechanical devices in the past.
4. A modern robot is a complex engineering structure.
5. It's difficult to predict what the robots of the future will look like.

VII. You have just listened to the lecture on the history of robot technology. You still have ten minutes before the break and the teacher has asked you to tell him what new facts you have learnt. Make a short report.

### Further Reading

I. There's a great number of new words and phrases in the following text. Study their meanings.

shake, <i>v</i>	<b>трясти, пожимать</b>
shake hands with smb	<b>пожать руку кому-л.</b>
clamp, <i>n</i>	<b>зажим; захват</b>
jaw, <i>n</i>	<b>тиски</b>
rigid, <i>adj</i>	<b>неподвижно закрепленный</b>

ridged, *adj* хребтообразный  
 deflect, *v* прогибать(ся), сгибать(ся), отклонять(ся)  
 grip, *v* хватать, сжимать, брать  
 elephant, *n* слон  
 trunk, *n* хобот  
 hose, *n* шланг

II. Read the title of the text and look at the pictures. What do you think the text is about? Would you like to shake hands with such a robot?

III. In the previous text you have learned some facts about the history of robots. Now read about the latest achievements in robot engineering.

### Shake Hands with a Robot



Shake hands with Vorscht - that's what engineers at University in Edinburgh are saying. Recently they have devised this brand new robot. Vorscht's handshake is not the metallic, jaw-like clamp of the robots that are used on production lines in industry. It's a softer, gentler grasp, like gripping the trunk of an elephant, or even shaking hands with another person.

Take a rigid plastic tube, rather like a vacuum cleaner hose. Close one end, and blow air in the other. The tube stretches slightly (see Box 1). The increased pressure inside the tube causes it to extend.

Take three of these tubes and mount them side by side to form an assembly called an actuator. Increase the pressure in two of the tubes, and the actuator bends (see Box 2). Reduce the pressure and it straightens up again. That's how the fingers on Vorscht's hands bend when they grip your hand.

#### BOX 1

An individual element is a plastic tube with ridged sides, like bellows.



Increasing the pressure inside the tube causes it to extend.

The sides of the tube are like a spring — reduce the pressure and it springs back to its original length. This occurs because of the elasticity of the material, like that of an elastic band.



## BOX 2

With two elements, the actuator can move from side to side. Greater pressure in element 1 makes it bend to the right. This is called bending in a plane.

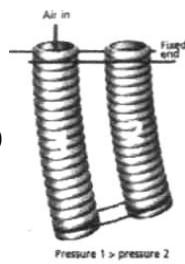

With three elements, an actuator can be made bend in any direction. The greater the differences in pressure, the more the tip of the actuator is deflected.

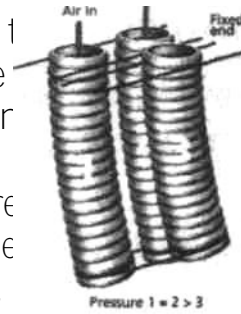

IV. Say if the following sentences are true or false. Correct the false ones.

1. Vorscht is the name of the company that produces robots.
2. When you shake hands with Vorscht you feel metallic jaw-like clamp.
3. The ridged plastic tubes that the robot consists of look like a vacuum cleaner hose.
4. When you increase pressure inside a ridged tube the tube springs back to its original length.
5. The tubes are made of elastic material.
6. When an actuator consists of three tubes it can't bend in any direction.

V. Explain to your group mates how this robot works.

1. Take a tube, ...
2. ... one end, ... in the other.
3. The tube ...
4. The increased ... causes it to extend.
5. If you increase the pressure in two of the tubes, the ...
6. If you reduce ..., the actuator ... again.

VI. You have just studied the work of different types of actuators at the practical class. Now explain to your friend the main differences between them. Consult the boxes on pages 150, 151.

VII. Make a list of different applications of such a robot as Vorscht.



## Activity

I. Work in pairs. Ask your partner if he has been to these places.

EXAMPLE 1. A: Have you ever been to the automobile works?

B: I have never been to the automobile works?

A: *Neither have I.* But I don't mind going there.

EXAMPLE 2.

A: Have you ever been to the tractor works?

B: I've never been there, but I've been to the machine-building works.

A: *So have I.*

### Phrases to use:

Japanese electronic company	British Steel works
Watch factory	Belarusian-German joint venture
Oxford University	Ball-bearing works

II. Group work. A very rich businessman wants to buy a robot to help his wife about the house. He has asked a prosperous engineering company to devise such a robot for him.

a) Engineers: Divide into small groups and design such a robot. When designing consider the following:

- its functions (ability to cook, clean, wash, perform different instructions)

- its cost

Present your project to the businessman.

b) Businessman: Listen to the presentation of each group and ask questions about these robots. Choose the robot you liked most.

## Writing

I. Expand the text about robots with the information given below. Use "*such as, for example, that...*".

You can begin like this:

Many of the robots today perform different jobs that are especially difficult for human workers, for example, they move heavy things and fix electronic parts.

Robots are used in various branches of industry, such as auto manufacturing and instrument making. ...

## Robots

Many of the robots today perform different jobs. Robots are used in various branches of industry. A modern robot is a complex structure with a number of components. Each of them performs a certain task. Scientists have recently developed new models of robots. Such robots are used for various purposes.

### Add this information:

1. Some jobs are especially difficult for human workers.
2. Robots move heavy things and fix electronic parts.
3. Robots are used in auto manufacturing and instrument making industries.
4. Manipulators do all the mechanical work.
5. Sensors detect heat, size and sound.
6. New models of robots imitate human beings.
7. These robots paint automobiles inside, help patients in hospital, carry fragile objects.

II. This is an extract from a scientific journal. Read and translate it into Russian.

## Man-made Man

In the past few years, we have seen important advances in computer science, biomechanics and material science, which have caused great changes in robot engineering.

Today a robot is not just a metal structure. It is already capable of expressing different emotions and imitating simple operations. Engineers and scientists have written a lot of complicated programmes for robots but it is still very difficult to make a thinking machine. Chess, for example, involves a great deal of human brainpower, but for robots playing chess is a simpler task than, say, making soup. A chess player needs only information and logic but what about making soup? You cut some vegetables, boil some bones, add some spices. But what vegetables and how many? How to distinguish potatoes from chicken? And, by the way, whose bones to put? And how can a robot possibly add salt with no sense of what "saltiness" means?

So you see that in order to have human-like machines that will work in real-world situations scientists still have a lot of work to do.

## Section B. Robots in Operation

### Lead-in

I. Have you ever seen how a robot works? Where did you see it and what operations did it perform?

II. Mr. Kosov, a reporter from the University newspaper, is talking to Paul, one of the students at this University. Listen to their dialogue and learn what the students do at the practical classes in robotics.

*Mr. Kosov:* Paul, I'd like to talk to you. I'm interested in your practical classes in Robotics. Will you tell me about them?

*Paul:* Certainly. Yesterday we watched how a robot worked.

*Mr. Kosov:* Really? Had you seen robots before that?

*Paul:* Well, yes, I had, but only on TV. In reality it's an impressive sight.

*Mr. Kosov:* What had you done before you started your work?

*Paul:* Before that we had prepared all the necessary workpieces and tools in our laboratory.

*Mr. Kosov:* That's very clever of you and in general do you like your practical classes in Robotics?

*Paul:* Oh, yes. We learn a lot of interesting information about robot engineering and at these lessons we can carry out different experiments ourselves. For example, last time our teacher gave us a task to perform a series of experiments with a gripping device.

*Mr. Kosov:* It sounds interesting. Have you finished your work yet?

*Paul:* Unfortunately, not yet.

*Mr. Kosov:* By what time will you have finished it?

*Paul:* I hope we'll have finished it by 4 o'clock today.

*Mr. Kosov:* Well, thank you very much. And good luck with your studies.

*Paul:* Thanks.

III. Complete the dialogues.

1. A: I'd like to talk to you about robot engineering. ...

B: ...

A: Really?

B: ... but only on TV. ...

2. A: Do you like your practical classes in Robotics?

*B:* ...

*A:* *It sounds interesting: 3.*

*A:* ...

*B:* Unfortunately, not yet.

*A:* ...

*B:* ... by 2 pm tomorrow.

IV. Match a line in A with a line in B.

**A**

1. Can you tell me about new achievements in robotics?
2. We checked a new device yesterday.
3. What had you done before Alex came?
4. Are you interested in robotics?
5. Have you prepared all the devices for the experiment?
6. Good luck with your exams.
7. By what time will you have improved the gripping device?

**B**

- a. I had finished the test.
- b. Thanks.
- c. Oh, yes, I am.
- d. Unfortunately, not yet.
- e. I'll have done it by next week.
- f. Certainly, with pleasure.
- g. Did you?

Language Practice

### *Vocabulary*

I. Match the English words with their Russian equivalents.

- |                |                   |
|----------------|-------------------|
| 1. research    | a) движение       |
| 2. effector    | b) возможность    |
| 3. force       | c) оборудование   |
| 4. pressure    | d) исследование   |
| 5. motion      | e) опасный        |
| 6. equipment   | f) давление       |
| 7. possibility | g) исполнительный |
| 8. hazardous   | h) орган          |
|                | h) сила           |

t. Make up all possible word combinations from both columns.

- |               |                   |
|---------------|-------------------|
| to widen      | information one's |
| to switch off | possibilities an  |
| to install    | experiment        |

to perform      equipment  
to provide      an electric device

### Grammar : Past and Future Perfect (Active)

III. Complete these sentences using the verbs in brackets.

EXAMPLE: Alex had prepared everything for the experiment by the beginning of the lesson, (*to prepare*)

1. I ... the switches on the control panel when the Instructor came. (*to check*)
2. The students ... a series of exercises by the end of the week, (*to perform*)
3. Paul ... the necessary measuring devices before the classes began. (*to prepare*)
4. The scientist... already ... a new model of a robot before he became famous, (*to develop*)

IV. You are now at the practical class in Robotics.

a) Ask your friend if he had done the following things by certain time in the past.

EXAMPLE: *to prepare everything by 5 o'clock*

A: Had you prepared everything by 5 o'clock yesterday?

B: Yes, I had. I had prepared everything by 5 o'clock yesterday.

or B: No, I hadn't. I had not prepared everything by 5 o'clock yesterday

to develop a new robot power system	<i>by that time</i>
to invent a new gripping device	<i>by the end of the week</i>
to widen the robot's abilities	<i>by 8 o'clock yesterday</i>
to increase product quality	

b) Ask your friend what he will have done by certain time in the future.

EXAMPLE: *to finish one's work by 5 o'clock*

A: Will you have finished your work by 5 o'clock?

B: Yes, I will. I will have finished my work by 5 o'clock.

or B No. I won't. I will not have finished my work by 5 o'clock.

to mount a new gripping device                      *by 4 o'clock*  
to finish the test with a new robot                *by that time*  
to develop a new type of an actuator              *by the end of the month*  
to design a new type of a robot

V. Ask your group mates what will have happened to these substances under different conditions.

EXAMPLE: *the lead - to heat to 1000°C - to melt*

A: What will have happened to the lead when you **heat it to 100 0°C**?

B: It will have melted.

liquid     - to cool to **-40 °C**             - to freeze  
gas         - to compress   - to explode  
water      - **to heat to 800 °C**           - to evaporate  
mercury   - **to heat to 100 °C**       - to expand

VI. Give the opposite to the following sentences.

1. By that time the students had already completed their research.
2. The students of our department will have passed all the exams by the end of May.
3. When the teacher entered the lab the mobile robot had already performed many different tasks.
4. When you come to see me I will have already finished to test a new industrial robot.
5. My assistant had done all the preparatory work by the time I came to the research room.
6. I will have already studied the new unit by 7 pm.

VII. Put all possible questions to the following statements. Consult the tables.

---

<b>a)</b>		<i>He</i>	<i>had</i>	<i>checked</i>	<i>a gripping device</i>	<i>by 5 yesterday.</i>
	Had	he		checked	a gripping device	by 5 yesterday?
	What	had	he	checked		by 5 yesterday?
	By what time	had	he	checked	a gripping device?	
		Who	had	checked	a gripping device	by 5 yesterday?

---

1. He had already become a famous scientist by that time.
2. The engineers had designed first robot systems by the end of the 19th century.
3. The engineers had equipped the robot with new sensors before they put it into operation.

---

<b>b)</b>	<i>She</i>	<i>will</i>	<i>have developed</i>	<i>a new method</i>	<i>by 5 tomorrow</i>
	<b>Will</b>	<b>she</b>	<b>have developed</b>	<b>a new method</b>	<b>by 5 tomorrow?</b>
<b>What</b>	<b>will</b>	<b>she</b>	<b>have developed</b>		<b>by 5 tomorrow?</b>
<b>By what time</b>		<b>will</b>	<b>she</b>	<b>have developed</b>	<b>a new method?</b>
	<b>Who</b>	<b>will</b>	<b>have developed</b>	<b>a new method</b>	<b>by 5 tomorrow?</b>

---

1. The engineers will have constructed a new moving device by the end of May.
2. The students will have completed an experiment before the class begins.
3. The robot designers will have developed a new model of a robot by the beginning of June.

VIII. Insert the necessary prepositions.

1. When people invented the robot they relieved themselves ... difficult work.
2. I have never seen a robot... action.
3. I need necessary information ... the robot's motions.
4. When you complete the work put all the devices ... storage.
5. The robot operates very accurately ... the help of a special device.
6. After the engineer had switched ... the device it began to work.

IX. Correct mistakes.

1. My brother had never study robot engineering before.
2. The teacher will has explain the new material by the time you come to the lecture.
3. Will have the engineers improved the electrical system by the beginning of September?
4. People invented mechanical devices long before the first robot was designed.
5. The students didn't have finished the experiment by the end of the lecture.

X. Translate the sentences into English using your active vocabulary.

1. - **Что вы сделали до того, как начался эксперимент?** - До того, как начался эксперимент, мы проверили все оборудование и подготовили необходимые материалы.

2. После того, как оператор включил необходимые приборы, робот начал выполнять ряд операций.

3. После того, как человек придумал робота, он освободил себя от монотонной и опасной работы.

4. Робот закончил все операции к шести часам.

5. - **Вы завершите эксперимент к семи часам?** - К сожалению, нет. Думаю, что мы выполним его к восьми часам.

## Reading and Speaking

**I.** In the text below you will find a word combination "feedback device". Can you guess what its function is? Scan the text to check your answer.

**II.** Yesterday the students of Robot Engineering had a practical class in Robotics. Look at these questions and read the text to find the answers.

1. How did the invention of the robot affect the man?

2. What system directs the manipulator's actions?

3. What did the robot do after the manipulator had finished all the operations?

4. Did the students enjoy the work of the robot?

5. What will the students have learned by the end of the term?

Man widened his possibilities and relieved himself from monotonous and hazardous tasks after he had invented the robot. Nowadays there's an endless variety of robots in the size, shape and jobs they perform. Scientists and engineers devise robots both for industry and homes. Some of the robots are experimental and look

more like living creatures. Many people are working today in the field of robotics and they are trying to find new applications for robots in the future.

Now let's have a look at some students of Technical University that study robotics. Yesterday they saw a robot in operation. They had never seen a robot before. After the operator had pushed some





buttons the robot began to perform a sequence of operations. By the *time the manipulator performed so2Xte actions, feedback devices had* provided the necessary information about *the robot's motions and positions*.

The control system directed the manipulator's actions. After the manipulator had completed all the operations, it put all the work-pieces into storage. With the help of a gripping device, the robot operated very accurately and precisely. When the robot completed all the actions the operator switched it off. By the end of the term the students will have learned everything about robot design, i.e. the body structure, the power system, the control system and various sensors, actuators and manipulators.

III. What expressions with these words can you find in the text?

robot, tasks, operations, device, actions, information; to relieve, to perform, to provide

IV. Complete the sentences.

The students ... never ... a robot before then. After man had ... the robot, he ... his possibilities and ... himself from monotonous and ... tasks. ... the time the manipulator ... some actions, feedback devices had ... the necessary ... about the robot's motions. By the end of the ... the students will everything about robot..., i.e. ... system, actuators, ... and ... systems.

V. Your friend and you carried out the first experiment with a robot yesterday. Tell your scientific supervisor what actions you both performed and what results you obtained.

Further Reading

I. When you read the text about the robot called Vorscht you learned the word "actuator". Do you remember what it means? Do the quiz to check your memory.

a) a device that analyses and stores information.

An actuator is ... b) a device that is always active.

c) a device which puts a machine into motion or mechanical action.

II. Look at the picture in the text. What do you think the text is about? Skim it quickly to check your answer.

III. Read the text attentively to learn how the most common manufacturing robot works.

When engineers devised a steam engine in the 18th century, some people said that they had already invented everything possible. However, our mankind has produced a great number of other inventions since that time. Robots are one of them.

Nowadays people use 90% of robots for heavy, repetitive manufacturing work. These robots handle tasks that are difficult, dangerous or boring to human beings.



The most common manufacturing robot is the robotic arm. It typically consists of seven metal segments. Tiny motors or actuators put them into operation when a special computer gives them certain instructions.

An industrial robotic arm with six joints closely resembles a human arm - it has the equivalent of a shoulder, an elbow and a wrist. This type of robot has six degrees of freedom, i.e. it can turn in six different ways. A human arm, by comparison, has seven degrees of freedom. Your arm moves your hand from place to place. Similarly, the robotic arm moves an end effector from place to place. You can supply robotic arms with all sorts of end effectors, which will perform a certain task, for example it will grasp and carry different objects. Robotic hands often have built-in pressure sensors that tell the computer how hard the robot is gripping a particular object. That's why the robot doesn't drop or break whatever it's carrying. Robots do their work more efficiently than human beings because they are so precise. They always drill in the exactly the same place, and they always tighten bolts with the same amount of force, no matter how many hours they've been in operation.

IV. Say whether these statements are true or false. Correct the false ones.

1. When engineers created a robot some people said that they had already created everything possible.
2. Engineers build 90% of robots for entertainment nowadays.
3. The most widely-spread manufacturing robot is the robotic arm.
4. You can supply the robotic arm with various actuators.
5. A special programme in the computer tells the robot not to drop the object it is carrying.
6. Robots are more efficient in their work than human beings because they are smarter.

V. Expand these sentences with the facts from the text.

1. People use robots in industry for various reasons.
2. The robotic arm resembles a human arm.
3. The end-effectors in the robotic arm perform different tasks.
4. Robotic hands often have built-in pressure sensors.
5. Robots are very precise in their work.

**VI.** You have just come back from the Motor Works where you watched the work of various robotic arms. Tell your friends about the structure of the robotic arm and the basic principles of its operation.

**VII.** Think of a good title to the text.

### Activity

I. Michael didn't attend the practical class yesterday because he was ill. But now he wants to know what his groupmates did at the class. Make up dialogues using the following model.

EXAMPLE: *Michal:* Did you control the gripping device yesterday?

*Alex:* No, I didn't. Paul had already done it.

*Michal:* When did he do it?

*Alex:* He did it the day before yesterday.

to test the new device yesterday / on Monday;

to measure the dimensions of the workpieces yesterday / two days ago;

to check the power system of the robot yesterday / long ago;

to control the quality of workpieces yesterday / last week;

to investigate the properties of engineering materials / the day before yesterday.

II. Discussion. It was long time ago when people devised the first prototype of a robot. Nowadays we are close to making human-like machines. Will these robots improve our life or will they make it worse?

- a) Read the following arguments and think of your own.

<i>For creating humanlike robots</i>	<i>Against creating human-like robots</i>
1. They will save us.	1. They will destroy us.
2. They help us in dangerous and routine tasks.	2. They can't work without constant supply of energy.
3. They never have any problems and never complain.	3. They can go out of control.
4.....	4 .....

c) Discuss the problem in groups of 3-5 students and try to reach an agreement.

### Writing

I. Study this picture and describe the operations of this industrial robot. The words below will help you.

a robotic arm, an end-effector, degree of freedom, built-in pressure sensors, actuators;

to pick up, to place, to grip, to carry, to pivot



II. Translate the text into Russian. Use the dictionary if necessary.

Different companies all over the world are trying to improve robots. The engineers and scientists at the Technical University in Eindhoven reported that they had created a new mobile robot. Let's have a look at their beautiful creature".

Hydraulic pistons move the robot legs back and forth. The pistons are attached to different leg segments just like muscles are attached to different bones. Engineers said it had been really difficult to make all these pistons work together properly. The robot figures out the right combination of piston movements in walking and it programs

this information into the robot's computer. This mobile robot has a built-in balance system that tells the computer when it needs to correct its movements-

The engineers from this University are working at another type of a mobile robot now and they will have built a more stable robot walker by the end of the year. It will have six legs like insects because of their exceptionally good balance and the ability to adapt well to a wide variety of unfamiliar environments.

## UNIT TEN

### AUTOMOTIVE ENGINEERING

#### *Section A. Some Car Systems*

##### Lead-in

I.a) List as many car systems as possible. Compare your list with the rest of the group. Who's got the longest list?

b) What is the fuel system used for?

II. Philip, a student of Automotive Engineering, has met his friend Alex in the laboratory testing. Listen to their dialogue and learn the basic principle of the carburettor operation.

*Philip:* Hello, Alex! What are you doing?

*Alex:* Well, I'm studying the fuel system of this car. Now I can tell you a lot about the basic principles of its operation.

*Philip:* Really? O.K. Let me see. Do you know the name of that little device near the engine?

*Alex:* Sure, it's called a carburettor.

*Philip:* And what is it used for?

*Alex:* Well, it measures out a precise amount of fuel that is mixed with the correct amount of air.

*Philip:* And do you know the principle of the carburettor operation?

*Alex:* Oh, that's easy. First, air is drawn down the air intake (it is located directly above the carburettor) into a venturi where its pressure is lowered. That's why, the fuel will flow into the venturi.

*Philip:* Will it flow because of the low pressure of the air?

*Alex:* Right you are. Then the air is mixed with the fuel before this mixture is taken into the cylinder combustion chamber.

*Philip:* Is it really? And what happens with this fuel mixture in the cylinder combustion chamber?

*Alex:* It is ignited there and is drawn into the engine afterwards.

*Philip:* I see.

III. Complete the dialogues.

1. A: What are you doing now?

B: ...

A: Can you tell me anything about it? B:

2. A: ...

B: Oh, it's called a carburettor.

A: And what is it used for?

B: ...

A: ...

B: That's easy. First air is drawn down the air intake into a venturi.

A: Where is the air intake located?

B: ...

A: And what happens next?

B: ...

A: I see.

IV. Match a line in A with a line in B.

**A**

1. Where were you yesterday?

2. What were you studying in the lab?

3. Where is the fuel mixed with the air?

4. What is a venturi?

5. What happens in the combustion chamber?

6. What is a carburettor used for?

**B**

a. It's a special tube in the carburettor.

b. It's used for mixing fuel with air.

c. The fuel system of a car.

d. The fuel mixture is ignited.

e. In the lab.

f. In the carburettor.

Language Practice

*Vocabulary*

I. Match the English words with their Russian equivalents.

a. steering

**привод**

b. accelerator

**двигатель**

c. advantage

**внутреннего сгорания**

d. independent suspension

**независимая подвеска бак**

e. internal combustion engine топливная система

f. drive ускоритель

g. fuel system рулевое управление

h. tank достоинство

II. Fill in the table with the missing forms of the following words. Use your dictionary if necessary.

<i>Verb</i>	<i>Noun</i>	<i>Adjective</i>
1. ...	safety	...
2. ...	...	separate
3. cool	...	...
4. ...	power	...
5. compress	...	...
6. detect	...	...
7. ...	...	adaptive
8. ...	improvement	...

III. Analyse the word combinations in the table and translate the following combinations into Russian.

Артикль	Существительное в роли определения	Определяемое существительное	Перевод
the	steam	engine	паровой двигатель
the	steam engine	cylinder	цилиндр парового двигателя
the	steam engine cylinder	improvement	усовершенствование цилиндра парового двигателя

the land transport

the land transport problem



the internal combustion engine  
the internal combustion engine improvement  
the vehicle motion  
the vehicle motion control  
the control device  
the control device application

### *Grammar: Present Simple Passive*

IV. Change the following sentences so as to use Present Simple Passive. Follow the model.

EXAMPLE: *A: We obtain petrol from petroleum. B: Petrol is obtained from petroleum.*

1. An engine produces power.
2. We usually use oil in different branches of industry.
3. They provide us with the necessary equipment.
4. The engineer controls the fuel systems.
5. Nowadays they make pistons from plastics.

V. Give the opposite to the following sentences.

1. This mechanism is used in the engine.
2. Power is not produced by the engine.
3. Fuel is burnt in the engine to produce power.
4. Fuel and air are not mixed in the carburettor.

VI. Your partner wants to check your knowledge of automotive engineering. Answer his questions. Use different adverbs of frequency such as *always, never, sometimes, often, seldom, usually*.

EXAMPLE: *a) Oil is used in diesel engines.*

*A: Is oil always used in diesel engines? B: Yes, it is.*

*b) Sulphur is used in petrol fuel.*

*A: Is sulphur always used in petrol fuel?*

*B: No, it isn't. It's never used in petrol fuel.*

1. Diesel fuel is used in different engines.
2. Gas is kept in a special tank.
3. Petroleum is needed in all branches of industry.
4. Fuel is carried by the fuel pipe.
5. Fuel is mixed with air in the carburettor.

VII. Ask all possible questions. Consult the table below.

---

	<i>Fuel is usually stored in a fuel tank.</i>
Where is fuel	usually stored?
Why is fuel	usually stored in a fuel tank?
When is fuel	usually stored in a fuel tank?
What is	usually stored in a fuel tank?

---

1. This fuel is used in all types of engines.
2. Fuel and air are compressed by the piston.
3. The body of the car is supported on the frame.
4. Gases are expelled from the cylinder.

VIII. Make up some questions for the following **answers**. **The answers need't** be true.

1. In the carburettor.
2. It is equipped with a new control system.
3. Engineers.
4. Petroleum.
5. The inventor himself.
6. In the fuel tank.

IX. Choose the right form of the verb.

1. This data is calculated / calculates by that electronic device.
2. Students are always solved/always solve complicated problems with the help of logarithm tables.
3. Our workshops are equipped / equip with automatic machinery.
4. A robot packs / is packed the necessary instruments for the experiment.
5. Useful information is provided / provides for the engineers.

X. Make up short dialogues. Pay attention to the place of the preposition of the passive construction.

EXAMPLE: A: As far as I know *they speak* a lot about this problem.  
B: Yes, you are right. This problem *is much spoken about*.

- to refer to the theory (seldom)
- to rely upon this method (usually)
- to deal with a new scientific problem (sometimes)
- to send for the mechanic (never)
- to think of the results of the experiment (always)

XI. Correct mistakes.

1. This car be powered by the energy of the Sun.
2. Machines are not maked of wood.
3. This car are equipped with the experimental fuel system.
4. To this theory is often referred in scientific literature.
5. Is our engineer invite to the scientific conference in Denmark?
6. How different fuels to be produced?

XII. Translate the sentences into English using your active vocabulary.

1. Из нефти вырабатываются разные виды топлива.
2. Топливный насос связан с карбюратором.
3. Топливо и воздух сжимаются поршнем.
4. - Что хранится в топливном баке? - Топливо.
5. - Где смешиваются воздух и топливо? - В карбюраторе.
6. Система охлаждения контролируется инженером.
7. Газ обычно хранится в специальной емкости.

Reading and Speaking

I. List all possible components of the fuel system in the car.

II. Now learn to pronounce the words which will help you describe a car.

**lubrication** [ˌluːbriˈkeɪʃən] *n*    **piston** [ˈpɪstən] *n*  
**pump** [pʌmp] *n*                      **separate** [ˈsepəreɪt] *adj*  
**carburettor** [ˈkɑːrbjʊretə] *n*

III. How many word combinations can you form with the noun *fuel*? Scan the text to check which of them are mentioned there.

IV. Now read the text attentively and learn about different mechanisms in a car.

A motor vehicle is a complex engineering construction. It is composed of several thousand parts. The smaller parts are joined together and form larger components, or units. One of the main components of any vehicle is, of course, the engine.

In addition to the engine itself, there are four separate mechanisms, which are used to feed the engine. These mechanisms are the fuel system, the lubrication system, the electrical system and the cooling system.

The fuel system is a separate mechanism that is used for feeding the engine. The fuel system consists of a tank, a fuel line or a pipe, a

pump and a carburettor. The engine produces power when air and fuel are mixed and burnt.

So let's have a look at the fuel system operation. The fuel is stored in a fuel tank. The fuel tank is connected to a fuel pipe. The fuel pipe carries the fuel to the fuel pump. This pump can be either electric or mechanic in operation. Electric pumps are generally situated near the fuel tank whereas a mechanical pump is generally located beside the engine. It is driven by the camshaft. The fuel pump is connected to the carburettor. In the carburettor the fuel is mixed with air. It is important to have the right ratio of air to fuel. For example, the optimum ratio of air to petrol in the fuel mixture is 15 parts of air to 1 part of petrol. The fuel and the air are compressed by the piston in the carburettor and they are drawn into the engine. In the engine the fuel and air are burnt and they produce power.

V. Answer the following questions.

1. How many mechanisms are there in addition to the engine itself? What are they?
2. When does an engine produce power?
3. Where is fuel stored?
4. The fuel pump is connected to the carburettor, isn't it?
5. Does the fuel pump carry the fuel into the carburettor or into the fuel tank?
6. Where is the fuel mixed with air?

VI. Complete the sentences.

1. There are ... mechanisms which ... for feeding the engine.
2. The ... is a separate mechanism which is ... to feed the ... .
3. Air and fuel ... mixed and ... .
4. The fuel... in a fuel tank.
5. The fuel pump ... to the carburettor.
6. In the carburettor the fuel is ... with ... .
7. The ... and air are ... into the engine.

VII. Now study this picture and describe how different mechanisms feed the engine.

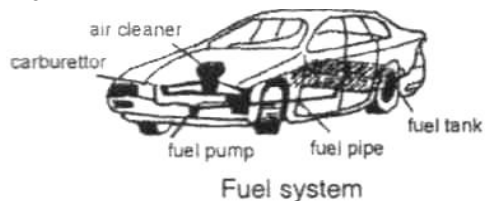

## Further Reading

I. Cars play a very important role in the modern world. In our everyday life we use cars probably more than any other means of land transport. But it's not very safe to drive a car today. What would you like to improve in a car? Discuss this problem with your partner.

II. Analyse the following compound nouns and translate them into Russian.

the automatic vehicle control	the steering wheel
the microprocessor controller	the steering device
the sensor information	the wheel motion system
the drive subsystem	

III. Nowadays car technology is constantly improving. Read the text about such improvements and be ready to answer the questions that follow.

The basic elements that control vehicle motion have changed little in their concept over the past few decades. Vehicles are still driven by an internal combustion engine, steering is achieved by driving a mechanical gear and brakes are actuated by physically pumping hydraulic pistons. All these actions are carried out by the driver.

The status quo is ready for change. Under development are fast-reacting, intelligent systems that increase the possibility of automatic vehicle control.

In such vehicles the steering, accelerator and brake devices are connected to a sensor that monitors their position. The sensor passes this information as an electrical signal to the microprocessor controller.

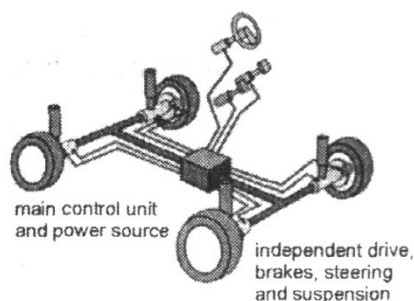

The sensor information is processed and the actions for the steering, brakes and drive subsystems are calculated.

The picture shows the outline of an automotive chassis. This differs from a conventional chassis as motion of each wheel is achieved by independent suspension, drive, brake and steering. The main control unit receives electrical signals from

the steering wheel and pedals, and produces electrical signals that actuate the wheel motion systems.

In this design there is a possibility to modify the steering, brake and accelerator device. All these could be integrated into a single joystick. This possibility is a major advantage when we want to modify cars for *the physically challenged*<sup>1</sup>.

<sup>1</sup> **страдающие каким-либо физическим недостатком**

1. Have the basic elements that control vehicle motion changed a lot over the past few decades?
2. What are vehicles driven by?
3. Who carries out all these actions?
4. What is under development now?
5. Do you think it's a good idea to develop automatic vehicle control?

IV. Arrange the operation stages of a typical automatic vehicle control.

- a) The sensor information is processed by this controller.
- b) A special sensor in the car monitors the position of the steering, accelerator and brake input devices.
- c) The actions for the steering, brakes and drive subsystems are calculated.
- d) This information is passed by the sensor as an electrical signal to the microprocessor controller.

V. Think of a title to the text.

## Activity

I. At the Motor Show in Minsk last week, you saw a totally new design of a car. It was equipped with "an intelligent vehicle motion control". You told your father about this innovation but he doesn't believe in all these improvements. Describe him how this system works and speak about its advantages. Are there any disadvantages? Work in pairs.

II. The first cars appeared at the end of the 19th century. Nowadays we can't imagine our life without a car. At the same time cars cause a lot of problems. So, is a car our friend or enemy?

- a) Read the following statements. Think of some more.

<i>Reasons to have a car</i>	<i>Reasons not to have a car</i>
1. It saves our time.	1. It is very noisy.
2. It carries heavy materials.	2. It pollutes air.
3. It's a very comfortable	3. Many people are killed or injured in car accidents.
4. It gives a chance to travel whenever and wherever	4. It does harm to your health, because you don't walk
5. It brings quick help (police, ambulance,	5. It causes traffic jams.
6. ...	6. ...

b) Discuss the problem in pairs and try to reach an agreement.

## Writing

I. Write a paragraph about the fuel system operation. The words below will help you.

a fuel tank, a fuel pipe, a fuel pump, a carburettor, a piston; to mix, to burn, to compress, to consist of, to produce

II. Translate the text into Russian.

A driver's response time is very slow in comparison to that of electronic systems. A quick human response is around 0.5 seconds, and some responses are as slow as 1 to 2 seconds. Let's consider a driver who is travelling at 40 mph and has a response time of 1 second. A simple calculation (distance = speed x time) shows that the car will travel 17.9 m before the vehicle motion is changed. In comparison, electronic systems operate at a tenth of a second and have the potential to operate in milliseconds. In severe maneuvers, the car stability is increased by this quicker response and people's life is saved.

## Section B. Designing Cars

### Lead-in

I. Discuss the following questions.

- a) Why are there so many models of cars today?
- b) How does the car design influence your choice of cars?
- c) A car designer is a very prestigious profession nowadays. Can you explain why?

II. Some students are at the exhibition "History of Cars". Listen to their conversation with the guide and learn how the first automobiles looked like.

*Guide:* ...If you look to the right you will see the first self-propelled steam-driven vehicle.

*Alex:* Who was it designed by?

*Guide:* It was designed by the French military engineer Cugnot in 1763. You see, it had three wheels and could carry only two passengers.

*Helen:* What was the maximum speed of this vehicle?

*Guide:* Four miles per hour. And it stopped every 15 minutes in order to make more steam.

*Alex:* Oh, that's not very comfortable.

*Guide:* Definitely not. But new motor cars with gasoline and diesel engines were introduced at the end of the 19th century. Look at that small car without a roof. It was constructed in 1893.

*Alex:* And where was the engine placed?

*Guide:* Right under the seat. The drivers always carried large cans of fuel and some spare tyres with them because there were no repair stations to serve them.

*Paul:* Unbelievable. I wouldn't like to be in these drivers' place. And what about that beautiful car? It seems pretty modern, doesn't it?

*Guide:* Well, that one is a famous Volkswagen Beetle, one of the world's most loved cars.

*Alex:* And why has it become so popular?

*Guide:* I think, mostly because of its design and low cost.

*Helen:* These cars are still in operation, aren't they?

*Guide:* Yes, they are. I'm sure they will be produced even in greater numbers in the future.



III. Complete the dialogues.

1. A: -...?  
B: -It was designed by Cugnot.  
A: -When was it designed?  
B: -...  
A: -...?  
B: -Well, the maximum speed was ....
2. A: -This small car was constructed in 1893.  
B: -...?  
A: -It was placed under the seat. ...  
B: -Why?  
A: -..., because at that time there were no repair stations.  
B: -...?  
A: -That is a famous Volkswagen Beetle.  
B: -...?  
A: -Yes, they are. And they will be produced in the future.

IV. Match a line in A with a line in B.

- | A   | B   |
|---|---|
| 1. Who was the Volkswagen Beetle designed by?     | a) It was designed by Rudolf Diesel.          |
| 2. Where was the first steam engine produced?     | b) I think, because of its attractive design. |
| 3. Why is this car so popular?                    | c) Let's hope for the best.                   |
| 4. When will new cars be designed?                | d) I think in a couple of years.              |
| 5. I hope your Mercedes will be repaired soon.    | e) By Ferdinand Porsche.                      |
| 6. Who invented a new internal combustion engine? | f) In France.                                 |

Language Practice

Vocabulary

I. Here are some more suffixes to make an adjective. Translate them into Russian.

Noun + -ful - Adjective (*наличие качества*)

Noun + -less - Adjective (*отсутствие качества*)

1. use - польза	useful - полезный
2. power - мощь	useless - бесполезный
3. care - забота	powerless –
4. help – помощь	powerful –
5. hope - надежда	careful –
6. colour - цвет	careless –
	helpful –
	helpless –
	hopeful –
	hopeless –
	colourful –
	colourless —

II. Match the words with their definitions.

- |               |  |
|---------------|--|
| 1. to adjust  | a) smth which is used to carry people or goods from one place to another |
| 2. to arise   |  |
| 3. to reduce  | b) to regulate for proper use  |
| 4. to detect  | c) to start or originate   |
| 5. to respond | d) a public road that is wide, well-paved and direct                     |
| 6. highway    | e) to react, to answer   |
| 7. vehicle    | f) to make or become smaller or less                                     |
|               | g) to discover the presence  |

III. Match the words with the similar meaning.

- |              |                   |
|--------------|-------------------|
| 1. feature   | a) provide        |
| 2. respond   | b) help           |
| 3. monitor   | c) device         |
| 4. detect    | d) characteristic |
| 5. improve   | e) answer         |
| 6. feed      | f) find           |
| 7. appliance | g) make better    |
| 8. assist    | h) control        |

### Grammar: Past, Future Simple (Passive)

IV. Change the following sentences so as to use Past and Future Simple Passive.

EXAMPLE 1: *I saw her in the workshop.*

She was seen in the workshop.

1. They sold the cars all over Europe.
2. They measured the temperature of water 5 minutes ago.

3. He increased the volume of liquid an hour ago.
4. We repaired the car yesterday.
5. They used this fuel for different engines.

EXAMPLE 2: *They will solve the problem tomorrow.* The problem will be solved tomorrow.

1. He will publish the results of the experiment next month. 2.1 will control the work of this device.
  3. We will explain the work of the carburettor next time.
  4. They will improve the car design.
  5. The new device will reduce the time of the operation.
- V. Ask an engineer about the advances in car design.

EXAMPLE 1: *the gearbox / to improve*

- Was the gearbox improved?
- Yes, it was.

the size of the car / to reduce the car design / to improve wheels / to modify mini motor cars / to design new types of fuel / to use

EXAMPLE 2: *the new models of cars / to build*

- Will the new models of cars be built in our country?
- I think, they will.

the cars / to power by the energy of the Sun the vehicles / to operate automatically the driver workload / to reduce the safety of motion / to improve the brakes / to apply.

VI. Ask your friend if he did these things himself.

EXAMPLE: A: *Did you repair this mechanism?(the mechanic)*

B: No, it was repaired by the mechanic.

1. Did you check this device? (the engineer)
2. Did you improve the work of the fuel pump? (the mechanic)
3. Did you connect these pipes yourself? (the instructor)
4. Did you control the cooling system? (the engineer)
5. Did you repair the car yourself? (the workers)

VII. Explain to your friend:

**a)** why these things will not be done.

EXAMPLE: *A: This device will not be tested.*

*B: Why won't it be tested?*

*A: Because it's broken.*

1. This fuel will not be burnt completely.
2. The power will not be switched on.
3. The work will not be finished.
4. The car will not be sent abroad.
5. The fuel will not be used for all engines.

**b)** when these things will be done. Use different adverbs of time.

EXAMPLE: *A: The work was not finished yesterday.*

*B: When will it be finished?*

*A: It will be finished tomorrow.*

1. This equipment was not installed in time.
2. Mini motor cars were not sold in Belarus last year.
3. This work was not completed properly yesterday.
4. The fuel system was not checked last time.
5. The tractors were not exported abroad a year ago.

VIII. These two sentences have a different structure but the same meaning. Change the structure of the sentences below so as to keep their meaning unchanged. Pay attention to the place of prepositions in the sentence.

EXAMPLE: *We listened to his lecture with great pleasure. His lecture was listened to with great pleasure.*

1. We sent for the mechanic two hours ago.
2. People spoke much about the new invention.
3. We will take care of the new equipment.
4. Teachers will refer to the results of this experiment.
5. The Professor paid attention to the work of this student.

IX. Insert necessary prepositions.

1. Michal is preparing ... his examination now.
2. I've heard a lot... the advantages ... electric cars.
3. People need petroleum ... all branches of industry.
4. The fuel is stored ... a fuel tank.
5. Vehicles are driven ... a combustion engine.

6. Automotive chassis differ a lot... conventional chassis.
7. The cars of the future will run ... solar energy.
8. The lecturer paid attention ... the design of a new minicar.

X. Correct mistakes.

1. The Belarusian National Technical University was not found in 1935.
2. An interesting problem will to be discussed at the lecture tomorrow.
3. When Belarusian State University was founded?
4. All the work was did by automatic machinery.
5. The Nobel prize be given to our outstanding scientist.
6. The testing of a new vehicle will be not completed by the end of the week.
7. The electric lamp was invented with Yablochkov.
8. To the work of this engineer was paid attention.

XI. Translate the sentences into English using your active vocabulary.

1. Этот автомобиль будет отремонтирован своевременно.
2. Почему это топливо не будет использоваться в автомобиле?
3. Большинство этих машин было сконструировано в Великобритании, не так ли?
4. Эксперименты проводились в лаборатории.
5. Вчера на нашем экспериментальном автомобиле была установлена первая система автоматического управления движением.
6. Новые заводы строились и будут строиться в нашем регионе.

## Reading and Speaking

I. There exist different types of cars and a mini motor car is one of them.

1. What do you know about this vehicle?
2. Have you ever seen or driven it?
3. Why is it called "mini"?
4. Are they widely used nowadays?

II. Scan the text quickly and say what it is about.

III. Now read the text attentively to learn more about mini motor cars.

Mini motor cars are sold all over Europe. The first Mini was produced in Britain in 1959 and it has become Britain's most popular and successful car since that time.

In the late 1950s, BMC, the British Motor Corporation, wanted to build a car that was different from other cars. They wanted a small, cheap and economical car -a family car that was big enough to carry four passengers. In the 1950s it was a difficult problem. At that time a typical family car was quite long, about three and a half meters. It had large wheels and large space for the engine. So there wasn't much room for the passengers. Besides that, it was very expensive to make.



The Mini was designed by Alec Issigonis. His design was revolutionary. First, the car was made half a meter shorter. Next, the wheels were made much smaller and they were put right at the four corners of the car. Then the engine was turned sideways and the gearbox was put underneath. And there was still enough room for four passengers.

Today nearly every small car is based on the design of the Mini. So why is the Mini so popular? The answer is simple: it is well designed, very economical, it is easy to drive around the city and easy to park!

**V.** Answer these questions.

1. When was the first Mini produced?
2. Who was this car designed by?
3. How did a typical family car look like in the 1950s?
4. What changes did Alec Issigonis make in a new car, called the Mini?
5. What are the advantages of the Mini?
6. Do you think that the Mini is a good car? Why? / Why not?
7. Would you like to drive such a car yourself?

**VI.** Complete the sentences.

1. Mini motor cars are ... all over Europe.
2. The Mini has become Britain's most... and ... car.
3. In the 1950s BMC wanted to build a ... and ... car.
4. The Mini... by Alec Issigonis.
5. The car ... half a meter ... .
6. The wheels were made ... .
7. The engine ... sideways and the ... was put underneath.
8. Today almost every car is ... on the ... of the ... .

VI. The Technical University will hold a students' conference tomorrow called "Small cars - a myth or reality?" Make a short report on mini cars.

## Further Reading

I. These words are from the text below. Study their meanings.

adaptive cruise control	<b>автоматическое управление движением</b>
longitudinal	<b>продольный</b>
lateral	<b>поперечный, горизонтальный</b>
steer-by-wire system	<b>система с кабельным управлением</b>

II. Look at the picture below and try to guess what this text deals with.

III. This is an extract from an article published in one of the British journals. Read it attentively and learn how some engineers imagine the future of the car.

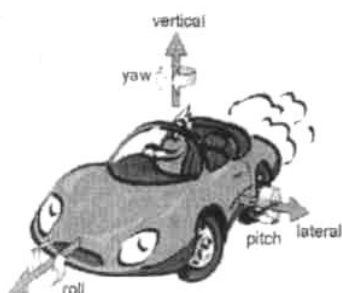

The vehicle of the future will be designed in a different way. These will be automatic vehicles with ACC or adaptive cruise control. The principle is that the car automatically adjusts its speed relative to its distance from and the speed of another vehicle. This removes the need for the driver to control the accelerator and thus the driver workload will be reduced considerably. ACC is a part of the longitudinal

control of the vehicle.

The next step in automating the longitudinal control is automatic braking systems (ABS) Here, the driver will be informed by these systems that a dangerous situation can arise unless action is taken. If the driver fails to respond, the brakes will be automatically applied and vehicle stability and driver safety will be maintained.

Laser and vision technologies are used to detect objects and ensure lateral control of the vehicle. The first systems will assist the driver through warnings; more advanced systems will use steer-by-wire systems to adjust the vehicle heading automatically.

The combination of lateral and longitudinal control of the vehicle motion is a new feature of the vehicle which will be used in an automated highway system.

IV. Answer these questions.

1. Will the vehicle of the future be the same as nowadays?
2. What kind of a car will we have?
3. What is ABS?
4. What is used to detect objects around a vehicle?
5. Would you like to have such an automatic vehicle with ACC and ABS? Give your reasons.

V. Give a title to this article.

## Activity

I. Your brother started working in a prosperous engineering company last year and he has saved enough money for a small, cheap car. Discuss advantages and disadvantages of buying a small car and give your brother a piece of advice.

II. Science and new technology are gradually changing everything in our life. Can you imagine how a car of the future will look like? Look at these statements and express your opinion on them. Give some other ideas of your own. Start with the phrases from the box. -

### EXPRESSING CERTAINTY AND DOUBT:

I'm (not)                      certain                      (that)...

(quite)                              sure

convinced

positive

There's no doubt that...

I doubt that/if...

1. All the cars will be of one colour, yellow.
2. The cars will not run on petrol.
3. There will be a lot of electric cars.
4. Some cars will run on solar energy.
5. Every car will have an air bag in front of the driver.
6. A driver will not have to drive a car because it will be automatic.
- 7....



## Writing

- I. How do you imagine a car of the future? Write a short description of it.
- II. Translate this text into Russian.

### What Is Mechatronics?

The word *mechatronics* was first used in 1969 to describe the integration of *precision mechanical engineering*<sup>1</sup> with electronic and computer control systems in order to make intelligent machines. Scientists wanted to bring together branches of engineering that are normally studied in isolation, in the hope that the design solutions will benefit both electrical and mechanical disciplines.

The range of applications of mechatronics is enormous and includes domestic appliances, automated assembly lines, computer peripherals and so on. Some specialists predict that mechatronic systems will be widely used in cars of the future. Mechanical devices will be controlled by the computer systems and thus the car's stability will be increased. On the whole a car will become a more efficient means of transport. All the mechatronic systems will operate independently and will help the driver control the motion of the vehicle.

<sup>1</sup>Точная механика

## UNIT ELEVEN

### ENGINEERING DESIGN

#### *Section A. Tractor Technology*

##### Lead-in

I. Discuss the following questions.

a) Where are cars used? What cars are used on farms?

b) Have you ever been to the Minsk Tractor Works? What production is it famous for?

II. Oleg hasn't seen his friend Paul for a long time. Listen to the dialogue to find out where he has been and what he has been busy with.

*Paul:* Hello, Oleg! How are you?

*Oleg:* Fine, thanks, Paul. What about you?

*Paul:* Very well, thank you.

*Oleg:* Where have you been? I haven't seen you for ages.

*Paul:* Oh, I have been really busy this week. You know, we have been shown an experimental tractor with a 6-cylinder engine at the Minsk Tractor works.

*Oleg:* How interesting! And why are there so many cylinders in the engine?

*Paul:* Well, this engine has been designed to provide precisely the right combination of power and torque for each job. So it's very efficient. And besides we have tested new oil filters.

They have been designed according to new tractor specifications.

*Oleg:* And what are the advantages of these filters?

*Paul:* Well, the main advantage is that they help to maintain internal cleanliness of the engine and protect against wear and corrosion much better than the old ones.

*Oleg:* That sounds good. By the way, where have these oil filters been tested?

*Paul:* In the testing field. Their work has been watched by the engineers. Soon these oil filters will be used in different types of tractors in our country.

*Oleg:* I see.

III. Complete the dialogues.

1. *A:* ...

*B:* Not bad, thanks. And what about you?

*A:* ...

2. *A:* I haven't seen you for ages! What happened to you?

*B:* ...

*A:* That's very interesting!

3. *A:* ...

*B:* They have been tested in our laboratory. Soon ...

*A:* ...

IV. Match a line in A with a line in B

**A**

1. Where have you been, I wonder?

2. What have you seen at the Works?

3. What has this tractor been equipped with?

4. What type of tractor is it?

5. What engine has been installed in this vehicle?

6. Why is this tractor so popular among farmers?

**B**

a. It's been equipped with a new

acoustical system.

b. A 6-cylinder engine.

c. Because of its outstanding performance.

d. I've been to the Tractor Works

e. An experimental tractor.

f. It's a general-purpose wheeled tractor.

## Language Practice

### Vocabulary

I. Match the English words with their Russian definitions.

1. environment      a) **работать**

2. to supply        b) **цель**

3. performance    c) **качество**

- |               |                              |
|---------------|------------------------------|
| 4. efficient  | d) успех                     |
| 5. to operate | e) снабжать                  |
| 6. purpose    | f) эксплуатационные качества |
| 7. quality    | g) окружающая среда          |
| 8. to demand  | h) усовершенствование        |
| 9. refinement | i) требовать                 |
| 10. success   | j) эффективный               |

II. Match the words with the similar meaning.

- |                |               |
|----------------|---------------|
| 1. mount       | a) improve    |
| 2. require     | b) production |
| 3. equip       | c) refinement |
| 4. enhance     | d) install    |
| 5. manufacture | e) demand     |
| 6. improvement | f) supply     |

III. Make up all possible derivatives from the following words and translate them into Russian.

<i>Verb</i>	<i>Noun</i>	<i>Adjective</i>
1. manufacture	manufacture	manufacturing
2....	manufacturer	manufacturable
3. produce	...	...
4....	introduction	...
5. ...	...	comfortable
6. ...	improvement	...
7. install	...	...
8. ...	reduction	...
9. adjust	...	...
10. ...	...	reliable

## Grammar: Present Perfect (Passive)

IV. Change the following sentences so as to use Present Perfect Passive.

EXAMPLE: A: They have equipped Ford tractors with climate control filters, haven't they?

B: Yes, Ford tractors have been equipped with climate control filters.

1. They have already cleaned the oil filter, haven't they?
2. You have repaired your tractor already, haven't you?
3. The engineers have provided these tractors with new equipment, haven't they?
4. They have modified shock absorbers, haven't they?
5. Our young engineer has improved the acoustical system in this tractor, hasn't he?

V. Change the statements so as to use the passive form of the verb. Mind the negative meaning of the sentence.

EXAMPLE: *to lock - to unlock*

A: It was long ago that the workshop was locked. B: It has never been unlocked since.

1. to lose - to find

This instrument was lost long ago.

2. to break - to repair

The brake system was broken last month.

3. to switch off - to switch on

The engine was switched off several hours ago.

4. to open - to close

The valve in this pipe was opened in the morning.

5. to increase - to reduce

The pressure in the system was increased yesterday.

VI. Answer your friend's questions about the following actions.

EXAMPLE: A: Has the application of filters been explained by the teacher?

B: Yes, it has been explained already. or No, it hasn't. It hasn't been explained yet.

1. Have the new trucks been chosen by the customers?
2. Has the air cleaner been widely used since its invention?

3. Have oil filters been improved during the field testing?
4. Have Ford tractors been trusted by many farmers?
5. Has the new tractor been equipped with climate control filters?

**VII.** Make up all possible questions. Consult the table.

---

		<i>A new device</i>	<i>has</i>	<i>been installed</i>	<i>in the tractor</i>	<i>recently.</i>
	Has	a new device		been installed	in the tractor	recently?
Where	has	a new device		been installed		recently?
		What	has	been installed	in the tractor	recently?

---

1. Transmission controls have been mounted on the flat floor recently.
2. The climate control system has been inspected by the engineer.
3. He has been asked many questions about the performance characteristics of the new tractor.
4. The Ford Company has been deeply involved in the development of tractor technology.

VIII. Make up some questions for the following answers. The answers needn't be true.

1. In the testing field.
2. Very soon.
3. At the Motor Plant.
4. Yes, it has.
5. New transmission controls.
6. They have been equipped with a hydraulic system.

IX. Choose the right verb form.

1. They (*have already increased, have already been increased*) the efficiency of a new tractor.
2. The oil filters in this vehicle (*have replaced, have been replaced*) recently.
3. This engine (*has just been tested, has just tested*) by our mechanic.
4. New refinements (*have introduced, have been introduced*) into this type of tractors.
5. The engineers (*have manufactured, have been manufactured*) the new acoustic system.

X. Correct mistakes in the following sentences.

1. The transmission control has been improve recently.
2. All these machines have been maked of metal.

3. Have been the new achievements in tractor engineering shown to young specialists?
4. A new model of a tractor has be delivered to the farm.
5. The driver's seat has provided with different comfort adjustments.

XI. Translate the sentences into English using your active vocabulary.

1. **Этот трактор только что отремонтировали.**
2. **Сегодня в нашу мастерскую были доставлены важные детали.**
3. **В ходе эксперимента ими были получены интересные результаты.**
4. **Уровень шума внутри кабины был значительно уменьшен современными акустическими системами.**
5. **Была ли проиллюстрирована на схемах работа топливной системы?**
6. **Почему задали много вопросов?**
7. **Когда была проконтролирована очистка масляного фильтра?**
8. **За последнее время были усовершенствованы многие механизмы тракторов.**

## Reading and Speaking

I. Nowadays there exist a lot of car companies all over the world. Some of them are very old some of them have just appeared on the market.

1. What famous car companies do you know?
2. Are there any famous corporations in your country?
3. Do they produce only cars?

II. All these words are from the text below. Learn how to pronounce them properly. Do you know their Russian equivalents?

<b>enable</b> [i'neɪbl] <i>v</i>	<b>halogen</b> ['hælədʒən] <i>n</i>
<b>efficiently</b> [i'fɪʃəntli] <i>adv</i>	<b>unique</b> [ju:'ni:k] <i>adj</i>
<b>acoustical</b> [ə'ku:stɪkəl] <i>adj</i>	<b>reliability</b> [ˌrɪlaɪə'bɪlɪti] <i>n</i>
<b>absorber</b> [əb's):bə] <i>n</i>	

Can you guess what the text is about?

III. The Ford Company is one of the most famous manufacturers of cars. Read the text to learn what other vehicles it produces.

Farming today demands constant gains in productivity. That's why the Ford Company research and improvement programmes never cease.

The Ford Company is known as a technologically advanced manufacturer of vehicles. For many years the Ford Company has been deeply involved in the manufacture of tractors, cars and trucks. Ford tractors enable farmers to work quickly and efficiently. The cab is a comfortable and efficient workplace. Modern acoustic systems have greatly reduced noise levels inside the cab. Transmission controls have been mounted on the flat floor. The driver's seat has been equipped with pneumatic suspension and it turns easily and gives the driver a more comfortable view. Air filtration, efficient heating and ventilation with air-conditioning further enhance comfort and the driver's efficiency. There's more. Individually adjustable halogen work lights have been installed into the cab roof.



These tractors have also been equipped with climate control filters and anti-burst door locks. Ford tractors are famous for their unique combination of outstanding performance, high reliability and cost efficiency.

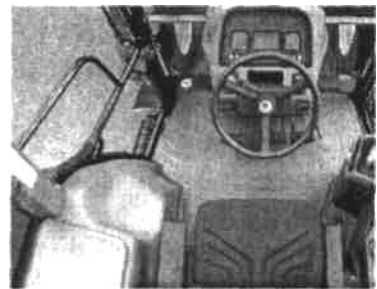

They have been continually improved since their introduction. Dozens of features and refinements have been added during recent years. Ford tractors have been trusted by generations of farmers due to their high quality.

### III. Answer the following questions.

1. What does farming demand today?
2. Why do the Ford Company research and improvement programmes never cease?
3. What is the Ford Company famous for?
4. Has the Ford Company been deeply involved in the manufacture of tractors, cars and trucks?
5. Ford tractors have everything to work quickly and efficiently, don't they?
6. What have these tractors been equipped with?
7. Why have Ford tractors been trusted by generations of farmers?



**IV.** Complete the sentences. Choose the suitable words from the list below.

The Ford Company produces not only **cars, but also 1 ... and 2 ....** Ford tractors are known all over the world for their high 3 ... and 4 ... and the Ford Company is always improving them. In a modern tractor you will see that 5 ... controls have been mounted on the flat

floor and six halogen work-lights have 6 ... into the cab 7 ~ .

Besides that, modern 8 ... systems have greatly 9 ... noise levels inside the cab. The tractors have also been 10 ... with 11 ... filters

and anti-burst 12....

reliability door locks tractors quality

been installed trucks equipped transmission

acoustical roof climate control reduced

**V.** Would you like to operate such a tractor? If so, give your reasons.

**VI.** Work in pairs. You are a sales manager at the Ford Company. Several farmers are looking for high-quality tractors and they have chosen your company. Try to persuade them to buy a Ford tractor.

### Further Reading

**I.** What types of tractors do you know? Look through the text to check your answers.

**II.** This extract is taken from a lecture on farm machinery. Read it attentively to learn about the latest improvements in tractor technology.

Needless to say, one of the most important industrial achievements for farmers today is the introduction of agricultural tractors in their work. Horses and men have been almost entirely replaced by tractors in many heavy and time-consuming tasks that are carried out on the land. A tractor performs the work of numerous horses and, what is of greater importance, it doesn't need any rest in order to recover from fatigue. If necessary attention is paid to its lubrication and it's constantly supplied with fuel, it will work on indefinitely.

During the years since its introduction, a huge progress has been made in developing a more efficient machine. Modern tractors have been constructed to meet all requirements of space, comfort, vision and safety. Many devices have been incorporated in the mechanisms of the tractor for this purpose. The 6-cylinder engines have been

installed in them for improved productivity and reliability. Some tractors have been equipped with a hydraulic system, which gives the driver the choice of the right power for every operation.

Nowadays there exists a wide range of different types of tractors. Let's say, the most common type today is the general-purpose wheeled tractor that is used on most farms and has an engine of up to 100 h.p. On the other hand if you need to carry out heavy cultivation on farms, you can use either track-laying tractors with a large horsepower (up to 500 h.p.) or heavy-wheeled tractors. Most present-day tractors are powered by internal combustion engines, which operate on the same basic principles.

**III.** Say if these statements are true or false. Correct the false ones.

1. The tractors are used instead of horses in many heavy tasks.
2. A tractor performs the work of one horse.
3. A tractor needs some time to recover from fatigue.
4. If the tractor's lubrication system is maintained in good condition, the tractor will work for a long time.
5. Nowadays there exist two types of tractors: the general-purpose wheeled tractor and track-laying tractor.
6. The hydraulic system in the tractor enhances the driver's safety.

**IV.** Find in the text the information about the following:

- a) an important industrial achievement for farmers;
- b) tractors after their introduction;
- c) a general-purpose wheeled tractor;
- d) a track-laying tractor;
- e) a heavy-wheeled tractor.

**V.** Give a title to the text.

## Activity

**I.** Several groups of engineers at the Minsk Tractor Works have been given the task to improve the tractor Belarus. Discuss the possible design of this tractor in your groups.

**II.** Several farmers from Russia have arrived at the Minsk Tractor Works in order to buy tractors. Present your project to these farmers and convince them to order your model of a tractor.

## Writing

I. Complete this paragraph about Ford tractors. Use the linking words from the box.

**EXPRESSING ADDITION**  
**moreover, in addition to, besides, as well as, also, furthermore**

Ford tractors are famous for high reliability and cost efficiency. They have been designed to provide a comfortable and efficient workplace. Climate control filters have been installed in the cab. Moreover, ...

Use some of these ideas:

1. acoustical systems - to reduce noise levels in the cab
2. transmission controls - to mount on the flat floor
3. the driver's seat - to equip with pneumatic suspension
4. halogen work lights - to install into the cab roof
5. ...

**III.** Translate this text into Russian.

The Minsk Tractor Works is the world's leading manufacturer of agricultural equipment. Since 1953 thousands of universal wheeled tractors under the manufacturer's brand "Belarus" have been produced.

The well-known advantages of these tractors are their low fuel consumption, long service life and simplicity and convenience of maintenance. The modern tractors have been fitted with six-cylinder diesel engines. Thus they can develop the sufficient horsepower under most unfavourable conditions and show a high efficiency. The nine-speed gearbox provides a wide range of speed for performance of all types of farm operations. The comfortable, safe and noise-proof cab provides excellent visibility and together with an adjustable soft seat, tinted glass, cab air filtering and a heating device ensures comfort for the driver throughout the whole working day.

All the features of "Belarus" tractors meet the international standard specifications.

## Section B. Machinery Engineering

### Lead-in

I. Engineers make use of machine tools in all their activities. List as many applications of machine tools as possible. Compare your list with that of your group mates.

III. Paul, a student of Mechanical Engineering, has visited an exhibition "Advances in Machinery Engineering" and now he is telling his friend Alex about it. Listen to their dialogue and learn how to name different machine tools.

*Alex:* Hello, Paul! Glad to see you. Where have you been? I was looking for you all day yesterday. But unfortunately, I didn't find you.

*Paul:* You know, our lessons had been finished by five o'clock yesterday and I went to our Exhibition Hall and saw different types of machine tools there, such as lathes, milling machines and grinding machines.

*Alex:* That sounds interesting. It's impossible to imagine a work shop today that is not equipped with multi-purpose machine tools.

*Paul:* I can't but agree with you. People have already fully automated all transportation operations.

*Alex:* And were there any interesting types of machine tools at the Exhibition, I wonder?

*Paul:* Oh, definitely, the latest developments in the design of machine tools were well represented there. And as far as I know, some of these types will have been put into operation by the end of the next year.

*Alex:* And what impressed you most of all at the Exhibition?

*Paul:* Well, you know, there was one fantastic machine known as the "machining centre". This machine performs about a hundred different operations simultaneously.

III. Complete the dialogues.

1. **A** ...

**B:** Well, you see, I had finished the test by 2 o'clock yesterday and I went to the machine tool works.

**A** ...

2. A: What types of machine tools did you see at the Exhibition?  
 B: ...  
 A: Which one did you like most?  
 B: ...  
 A: Will any of these new machine tools have been put into operation by the end of the year?  
 B: ...

IV. Match a line in A with a line in B.

- | A  | B  |
|--|--|
| 1. Where were you yesterday?                             | delivered?   |
| 2. Has the new lathe been tested yet?                    | a) A microprocessor.                                   |
| 3. What is the oldest tool that is known to the mankind? | b) By May 10.  |
| 4. Who was the first machine tool invented by?           | c) John Wilkinson.                                     |
| 5. What has been incorporated in this machine tool?      | d) The engineers said that it had already been tested. |
| 6. By what time will the machine tool have been          | e) I was at the machine tool works.                    |
|  | f) I don't know, I'm afraid.                           |

### Language Practice

---

### Vocabulary

---

I. Match the words with the opposite meaning.

- |                          |                          |
|--------------------------|--------------------------|
| 1. hand tool             | a. unimportant           |
| 2. advantage             | b. automatic             |
| 3. accurate              | c single-purpose machine |
| 4. give                  | d. disadvantage          |
| 5. important             | e. inaccurate            |
| 6. multi-purpose machine | f. receive               |
| 7. manual                | g. machine tool          |
| 8. simple                | h. complex               |

II. Match the word with its definition.

- |              |   |
|--------------|---|
| 1. tool      | a. to take away, to get rid of                                |
| 2. workshop  | b. a thing with the help of which an operation is carried out |
| 3. to shape  | c. to turn in a new direction                                 |
| 4. to cut    | d. a room in which manufacture is carried out                 |
| 5. to remove | e. to separate into slices or pieces                          |
| 6. workpiece | f. to form, to make   |
| 7. to bend   | g. a piece of metal/substance for work.                       |

III. Match the English word combinations with their Russian equivalents.

- |                       |   |
|-----------------------|---|
| 1 a lathe             | a) фрезерный станок                     |
| 2 a milling machine   | b) сверлильный станок                   |
| 3 a drilling machine  | с) шлифовальный станок                  |
| 4 a numerical control | d) токарный станок                      |
| 5 a cutting tool      | e) режущий станок                       |
| 6 a grinding machine  | f) числовое программное управление, ЧПУ |

IV. Write down all possible derivatives *of* the following words.

<i>Verbs</i>	<i>Nouns</i>	<i>Adjectives</i>	<i>Adverbs</i>
to vary			
to conduct			
to resist			
to act			
to remove			

*Grammar: Past and Future Perfect (Passive)*

**IV.** Find the verb in Perfect Passive in every line.

- |                      |                 |                       |
|----------------------|-----------------|-----------------------|
| 1. a) are delivering | b) delivered    | c) had been delivered |
| 2. a) had received   | b) is receiving | c) had been received  |

- 3.a) reduce            b) will have been reduced    c) will be reduced  
 4.a) will predict    b) had been predicted        c) had predicted  
 5.a) will be given    b) will have been given        c) are given  
 6.a) will have        b) was removed                c) had been removed removed  
 7.a) will have        b) has adjusted                c) will have adjusted been adjusted  
 8.a) had been        b) will be repaired            c) was repaired repaired

**V.** Change the following sentences so as to use passive form of the verb underlined.

EXAMPLE 1: *A: They had finished the experiment before the lesson was over.*  
*B: The experiment had been finished before the lesson was over.*

1. He had completed the chemical reaction when the teacher came.
2. We had published the results of our work by the end of the year.
3. They had dried the sample before the experiment started.
4. They had begun the experiment before the assistant came.
5. They had obtained all the necessary data by the time the experiment began.

EXAMPLE 2: *A: We will have published the article by the beginning of the conference.*

*B: The article will have been published by the beginning of the conference.*

1. By the end of the next month he will have repaired his car.
2. They will have brought the necessary tools by the beginning of the work.
3. We will have improved this tool by the end of the year.
4. They will have delivered new books to the library by the end of the week.
5. They will have installed new equipment in the practical classes by the beginning of a new academic year.

VII. You completed your practical work at the Machine-building plant last week.

- a) Say what work had been done by the end of your practice.

EXAMPLE: *to perform a lot of different operations*

A lot of different operations had been performed by the end of the practice.

to study the operation of the milling machine  
 to deliver a new model of a lathe  
 to instruct the students properly  
 to investigate the advantages of machine tools  
 to obtain valuable practical experience

b) Say what work will have been done by the end of this term.

EXAMPLE: *to write the course project*

The course project will have been written by the end of the year.

to carry out the research on machine tools  
 to repair the old cutting tool  
 to demonstrate the work of metal-cutting machines  
 to perform various operations on the drilling machine  
 to experiment with metal-forming machines

**VII.** Ask all possible questions. Consult the tables below.

---

	<i>The device</i>	<i>had been repaired</i>	<i>in our lab</i>	<i>by the end of the day.</i>	
	Had	the device	been repaired	in our lab	by the end of the day?
By what time	had	the device	been repaired?		
Where	had	the device	been repaired?		
	What		had been repaired	in our lab	by the end of the day?

---

1. A new machine tool had been devised by the end of the week.
2. The experiment had been finished in our laboratory before the lesson was over.
3. The engineers had improved the design of this machining centre before the plant began to produce it.

---

		<i>The workpiece</i>	<i>will have been cut</i>	<i>by 2 o'clock.</i>
	Will	the workpiece	have been cut	by 2 o'clock?
By what time	will	the workpiece	have been cut?	
	What		will have been cut	by 2 o'clock?
	What		will have been done	by 2 o'clock?

---



1. A new milling machine will have been introduced in this plant by the beginning of May.
2. A new cutting tool will have been put into operation by the time our workshop opens.
3. The research will have been completed by a group of engineers by the time you arrive.

IX. Correct mistakes in the following sentences.

1. New safety rules have been established by the end of the last year.
2. A new device will be designed by next week.
3. Will have the design of the tool been improved by the end of September?
4. The necessary tools were brought into the laboratory by the beginning of the experiment.
5. These new properties of the substance had predicted by the scientists before the experiment began.
6. The construction of the workshop will have be completed by next year.

X. Translate the sentences into English using your active vocabulary.

1. Они выполнили ряд операций на токарном станке до того, как закончились лабораторные занятия.

2. Вчера к 5 часам вечера фрезерный станок был отремонтирован.

3. Образцы многоцелевых станков были изготовлены до того, как начался эксперимент.

4. Статья будет опубликована до начала конференции.

5. Один станок с централизованным программным управлением контролирует работу более ста различных режущих инструментов.

6. Коробки передач изготавливаются на призматических станках.

## Reading and Speaking

I. Learn to read the following words. Say which of them are international.

component [kəm'pəʊnənt]

category ['kætɪgəri]

prismatic [prɪz'mætɪk]

hollow ['hɒləʊ]

casing ['keɪsɪŋ]

II. Analyse the following word combinations and translate them into Russian.

machine tools                      mechanical engineering workshop  
machine tool types              metal cutting machines

III. What is the difference between a hand tool and a machine tool? Look through the first passage of the text to find it out.

IV. There exists a great number of machine tools that can be used by engineers in their work. Read the text about different types of machine tools for more information.

Scientists consider that the oldest tools that are known to the mankind are 2,600,000 years old. They were used by people in manual operations and that is why they were called hand tools. By the beginning of the Industrial Revolution, people had already devised simple hand tools for cutting and shaping different materials. But in the 18th century there appeared machine tools that made mass production a reality in the 19th century. A machine tool is a power-driven machine that is used to perform different operations with metal or other material. Basic machine tools use mechanical power to bend, cut, drill, grind and hammer metal into desired shapes. More advanced machine tools use such power sources as electrical or chemical energy, heat, magnetism and ultrasound.

Nowadays machine tools play an important role in the manufacture of almost all metal products. Machinists (people who operate machine tools) use them in making automobiles, radios, refrigerators, television sets and so on. Every mechanical engineering workshop is equipped with machine tools. They are the main source for the manufacture of component parts of all machines and mechanical devices.

There are about 500 kinds of machine tools. Some perform a single operation, such as grinding or drilling. Others, called machining centres, carry out several kinds of tasks. These numerous machine tool types fall into two categories. The first group is called "metal cutting". The machine tools of this group remove some material from the workpiece and they are much stronger than the workpiece itself. The examples of metal cutting machines are lathes, drill presses, milling and shaping machines.

The second group is called "metal forming". They shape the work-piece without the removal of any material from it. For metal forming operations we use a wide range of *forging machines*<sup>1</sup>, presses and press *brakes*<sup>2</sup>.

<sup>1</sup> **КОВОЧНАЯ МАШИНА**

<sup>2</sup> **ПРЕССОВЫЕ ТОРМОЗА**

**V.** Answer the following questions.

1. What is a machine tool?
2. Where do we use machine tools?
3. How many machine tools are used in industry nowadays?
4. What are the two main types of machine tools?
5. Is there any difference between the first and the second group of machine tools?

**VI.** Say if the following sentences are true or false. Correct the false ones.

1. The first hand tool was used during the Industrial Revolution of the 18th century.
2. Machine tools never use such power sources as heat and chemical energy.
3. Machinists are the people who operate machine tools.
4. Machining centres perform a single operation, for example, drilling.
5. A lathe is an example of metal forming machines.

**VII.** Complete the text using the diagram.

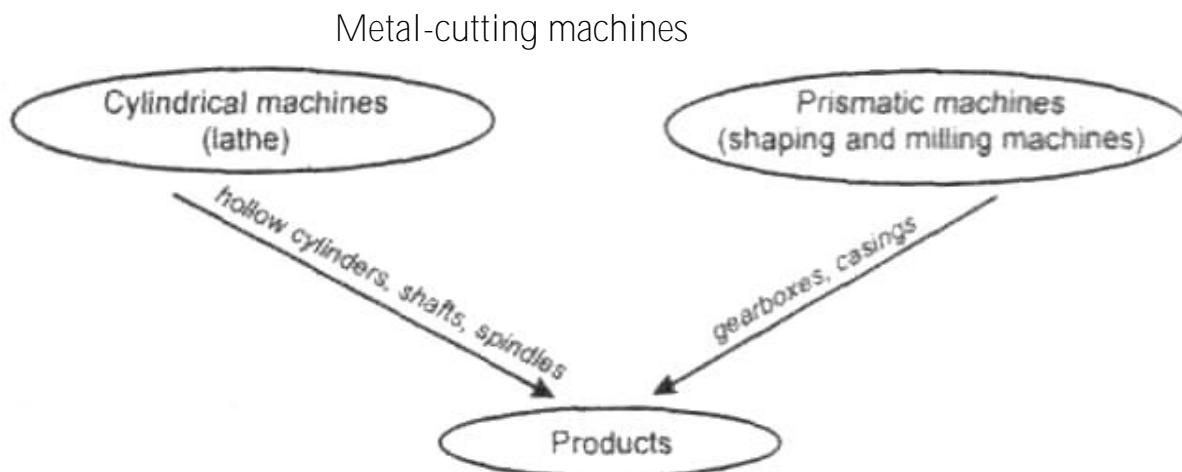

This diagram shows the subdivision of metal-cutting machines. This subdivision may be made between ... and ... machines. Cylindrical machines produce ....., and ... may be said as the best known machine tools of this type. Prismatic machines produce ... and ... and ... machines may be said as the best known machine tools of this type.

VIII. a) You are going to deliver a lecture to the students of metallurgy on different types of machine tools. Make an outline of your lecture (maximum 10 sentences)

b) Give the lecture to the students. Be ready to answer their questions.

## Further Reading

I. Learn how to read the following words.

precise [pri'saiz]

particular [pə'tɪkjʊlə]

**fixture** ['fɪkstʃə]

numerous ['nju:merəs]

II. What do these abbreviations stand for? Look through the text to find it out.

CNC, NC, DNC

III. Where can numerical control systems be used? Read the text to learn more about NC systems.

In 1775 John Wilkinson, an English ironmaker, invented the first modern machine tool. It was a boring machine that enabled the workers to drill precise holes in metal. Many refinements have been incorporated in machine tools since that time.

By the middle of the 20th century some machine tools had been linked together in series for use in mass production. And in the 1950s the first machines with numerical control were introduced.

Numerical control, commonly called NC, is a system of automating machine tools. Let's have a look at some examples of NC systems application.

The system known as computer numerical control (CNC) has a number of machine tools, each of which is directed by its own computer. So when you want to adapt a CNC machine tool to a different job you just change the control programme, or software of the computer. They are very easy in operation, their programming is simple and you can always test it. Moreover, they are cheaper to maintain and are generally more accurate in comparison with standard machine tools. CNC systems are used with a wide range of machine tools such as milling machines and lathes. Many are equipped with graphic displays that show the shapes of the workpiece and can even produce three-dimensional views of the components.

When several CNC machine tools receive instructions from a large central computer that stores and processes operational procedures, we can speak about a direct numerical control (DNC). This single computer controls more than 100 machine tools.

A further development in the automation of machine tools is the "machining centre". This machine has automatic tool changers and

performs a lot of machining operations on a workpiece with the help of more than 100 different cutting tools. One machining centre can do the work of eight or more standard machines. They are particularly useful when you need to produce large and complex components with the high degree of accuracy.

In general, all machine tools that are equipped with NC systems have a lot of advantages. One of the most important advantages is the absence of necessity to design, build and store the numerous fixtures.

IV. Answer the following questions.

1. What is the main advantage of CNC machines?
2. What is the difference between CNC and DNC machines?
3. How many tools may a DNC machine contain?
4. What is the main principle of work of machining centres?
5. If you were a director of a steel factory would you like to install there machine tools with NC systems?

V. Say if the following sentences are true or false. Correct the false sentences.

1. John Wilkinson invented the first modern NC machine tool.
2. Nowadays NC systems are hardly ever used in industry.
3. CNC machine tools are more accurate in comparison with standard machine tools.
4. One machining centre may perform the work of 100 standard machines.
5. If a worker wants to produce a complex component with high degree of accuracy he should use one of the NC machine tools.

VI. Read the following summary of the previous text and fill in the missing information with the words given on page 205.

Automation of machine tools began in the 20th century. In the 1950s the first machines with ... were ... .

Numerical... is a system of automating machine ... .

Computer ... control machine tool is directed by a ... . CNC machines are easy in ... and they are ... to maintain.

In ... system a single computer may ... more than 100 machine tools.

Machining centres may ... a lot of machining ... on a ... at a time. One machining centre may do the work of eight... machines.

... NC systems have ... advantages.

computer in general introduced tools perform  
 a lot of numerical control operation numerical operations  
 control direct numerical control standard cheaper workpiece

VII. Give a title to the text.

## Activity

I. **You've** just visited the Belarusian Historical Museum. There was an excellent exhibition of different kinds of tools from the oldest to the most modern ones. Share your impressions with your friends.

Some of the tools at the exhibition were:

hand tools made of wood, stone and copper;

the first cutting machine tools;

a modern lathe and a drilling machine; machining centre.

II. A group of students has come to the Steel works where you work. Show them around and tell them about different machine tools that you have at the works.

III. Discussion. It's impossible to imagine present-day manufacturing process without machine tools. They bring a great number of benefits but do they possibly have any disadvantages?

a) Read the following arguments. Think of your own ones.

### *Machine Tools*

<i>For</i>	<i>Against</i>
1. They make people's work easier.	1. They are dangerous in operation
2. They perform numerous operations simultaneously.	2. If the computer programme fails, the production stops.
3. They are fast and accurate.	3. It's difficult to repair them.
4. They don't get tired.	4. They require regular maintenance.
5. ...	5. ...

b) Discuss the problem in groups and try to reach an agreement.

## Writing

I. Write two paragraphs, one about advantages and the other about possible disadvantages of machine tools.

II. Translate the text into Russian. Use your technical dictionary.

By the beginning of the new millenium a great number of complex machine tools had been designed to speed up production. Although these tools include features of the basic machine tools and perform the same operations, they incorporate design modifications that let them perform complex operational sequences quicker. Furthermore, after the production machine has been set up by a skilled worker or machinist, a less skilled operator also can produce parts accurately and quickly.

There's one more improvement that had already been incorporated in machine tools by the 21st century. This is a highly automated machining system, called adaptive control that involves the use of a microprocessor. A microprocessor is a tiny electronic device that performs the work of a computer. The microprocessor regulates variables in the machining process such as the speed of the spindle. That makes the process very efficient. It also receives information from sensors that measure force, temperature, and other variables. It uses the information to operate the system at the level that is safe for the machine tool and the workpiece. Specialists predict that by the year 2015 all major industrial works in Belarus will have been equipped with such machining centres.

## UNIT TWELVE

### MATERIALS SCIENCE

#### *Section A. Copper*

Lead-in

I. Discuss the following questions.

- a) How much do you know about copper?
- b) Where is copper used today? Make a list of possible applications of copper. Compare it with that of your group mates.
- c) Do you know any copper alloys? What are their constituents?

II. The students are at the seminar on metals technology. Listen to their discussion and learn what properties copper has and where it can be used.

*Teacher:* Dear students, today we're going to discuss the main properties and applications of copper. So far, what can you say about this metal?

*Andrew:* If I'm not mistaken, copper is a non-ferrous metal. And it can be found in a free state in nature.

*Alice:* And as far as I remember, people were able to extract this metal in prehistoric times. Various things such as weapons, tools and decorations could be made of it.

*Teacher:* Very good. Were those copper tools very reliable?

*Andrew:* I think not. Pure copper is a soft ductile metal. Strong cutting tools could be made only of copper alloys such as bronze.

*Teacher:* OK. What are the present applications of copper?

*Alice:* Well, they are numerous. Copper metals can be used in most domestic appliances. Electrical industry is impossible without copper wiring as it is a very good conductor of electricity. Also, copper is corrosion resistant which makes it valuable for marine industry. Besides, this metal is even used in making money!



*Teacher:* You are quite right. Tomorrow we will be able to study the valuable properties of copper in the practical class.

III. Complete the dialogue.

A: Are we going ....today?

**B:** - ... . Let's remember what...

A: - I know that copper ....

**B:** - Very well, and when ....?

A: -...

**B:** -What applications ....?

A: - ...

**B:** - Why did bronze become so ...?

A: - ...

**B:** - Can you prove that copper ...

A: today?

**B:** - What valuable properties ...?

A: - Well, ...

**B:** - Excellent! I see you know a lot about copper.

IV. Match a line in A with a line in B.

**A**

**B**

1. Copper was discovered long ago.

2. Is copper used in automobile industry?

3. Bronze was first produced in Asia and Africa.

4. Why is copper so widely used today?

5. Electric wiring is made of pure copper, isn't it?

6. Thank you very much.

a. Yes, it is.

b. Where exactly?

c. You are welcome.

d. You are quite right.

e. Because of its valuable properties.

f. Certainly.

Language Practice

\_\_\_\_\_ Vocabulary

I. Learn how to read these words.

ductile ['daktail]

reliable [ri'laɪəbl]

decorative ['dekəreɪtɪv]

recycling [ri'saɪklɪŋ]

plumbing ['plʌmɪŋ]

II. Match the Russian words with their English equivalents.

- |                        |                        |
|------------------------|------------------------|
| 1. оценивать           | a. qualities           |
| 2. извлекать           | b. conductor           |
| 3. проводник           | c. purpose             |
| 4. домашний            | d. to extract          |
| 5. вязкий (эластичный) | e. ductile             |
| 6. нержавеющей         | f. domestic            |
| 7. качества            | g. to estimate         |
| 8. цель                | h. corrosion resistant |

III. Match the words with the opposite meaning.

- | A             | B              |
|---------------|----------------|
| 1. useful     | a. varied      |
| 2. ability    | b. decorative  |
| 3. functional | c. tremendous  |
| 4. magnetic   | d. unnecessary |
| 5. present    | e. useless     |
| 6. small      | f. inability   |
| 7. necessary  | g. ancient     |
| 8. uniform    | h. nonmagnetic |

*Grammar: Modal Verbs "can, could, be able to"*

IV. Say what these people could do in the past.

EXAMPLE: I *can't use* the new apparatus now but I could use it yesterday at the lesson.

1. He can't do research on copper alloys this term but he ... it last term.
2. We can't compare the properties of these substances now but we ... them during our previous experiment.
3. They can't study aluminium bronze at the lesson now but they ... it in the lab yesterday.
4. We can't extract copper with the help of stone and bone tools but ancient people ... it in this way thousands of years ago.
5. I can't describe the results of his experiment today but he ... them yesterday.

V. Use the following statements in the past and future.

EXAMPLE: He can drive well.

He could drive well 10 years ago.

He will be able to drive well in a month.

1. He can continue his studies at the Mechanical Engineering faculty.
2. Our engineers can extract copper in several ways.
3. I can visit the Bingham Canyon copper mine.
4. This new car can move without a driver.
5. The scientists can use the samples of this substance in the test.

VI. Ask your scientific supervisor to explain what can happen to these engineering materials.

EXAMPLE: *copper / to be alloyed with iron*

A: Can copper be alloyed with iron?

B: Certainly it can. Copper can be alloyed with iron.

or I'm afraid it can't. Copper can't be alloyed with iron.

a ductile metal / to be worked into a new shape

copper / to be used as a conductor of electricity

tin / to be alloyed with copper

brass / to be used in bearings and gears

copper / to be recycled several times

VII. Put these statements into Present, Past and Future using the modal expression to *be able to (not to be able to)* instead of *can (can't)*.

EXAMPLE:

+

I can study materials science.

I am able to study materials science.

I was able to study materials science.

I will be able to study materials science.

-

He can't complete this work himself.

He is not able to complete this work himself

He was not able to complete this work himself

He will not be able to complete this work himself

1. We can alloy copper with aluminium.
2. The engineers can use copper for electrical conductors.

3. I can do research on phosphor bronze now.
4. She cannot explain the properties of this group of alloys.
5. This student cannot explain the difference between brass and bronze.
6. They cannot evaluate the results of the first series of experiments.

VIII. Correct mistakes in the following sentences.

1. We didn't can work in the laboratory on Sunday.
2. Will be you able to make a report on your scientific research?
3. He could to use the old equipment in his experiment.
4. The teacher can explains this rule again.
5. You will able to cut soft metal with greater speed than hard metal.
6. Engineers will be not able to use this new alloy in industry, I'm afraid.
7. The student not able to determine the nickel content of this copper alloy.
8. Can this technology to make the extraction of copper easier?

IX. Translate the sentences into English using your active vocabulary.

1. В качестве электрического проводника мы можем использовать медь.
2. Он способен объяснить, как добывают медь в промышленных целях.
3. Мы смогли изучить свойства алюминиевой бронзы на практических занятиях.
4. Бронза может оказывать сопротивление коррозии.
5. Преимущество меди в том, что ее можно перерабатывать несколько раз.
6. Медные сплавы могут быть использованы в разных отраслях промышленности.

## Reading and Speaking

I. These words are taken from the text. Use the dictionary to find out their meaning.

rather, <i>adv</i>	remainder, <i>n</i>
circulation, <i>n</i>	throughout, <i>prep</i>
vital, <i>adj</i>	discarded, <i>adj</i>
junked, <i>adj</i>	demand, <i>n</i>

II. Skim the text to find answers to these questions.

1. Is copper the oldest metal that is known to man?
2. What properties does copper possess?
3. What is bronze?
4. When, where and why did bronze appear?
5. What are the applications of copper and its alloys?
6. Why aren't we afraid of working out the resources of copper?

III. Read the text attentively for more information about copper.

Copper is man's oldest metal as people could extract it more than 10,000 years ago. As it is rather soft and ductile, copper is alloyed with other elements. There is evidence that the first copper alloy — bronze (90% copper, 10% tin) - was produced around 2800 **BC** in countries such as India, Egypt and Mesopotamia. Bronze was harder and could be used for making reliable cutting tools. Its use characterizes the Bronze Age.

The workability and the ability for corrosion resistance made copper, bronze and brass the most important functional as well as decorative materials from the Middle Ages and on till the present day. With the beginning of the Electrical Age the demand for copper increased tremendously because it is an unusually good conductor of electricity and heat. Today more than 5 million tons of copper are produced annually and the copper metals are playing an increasingly vital part in all branches of modern technology.

The good news is that we will not run out of copper. The worldwide resources of this important and valuable metal can be estimated at nearly 5.8 trillion pounds of which only about 0.7 trillion (12%) have been mined throughout history. Besides, nearly all of 700 billion pounds is still in circulation because copper's recycling rate is higher than that of any other engineering metal. Each year nearly as much copper is recovered from recycled material as is obtained from newly mined ore. Almost half of all recycled copper scrap is old post-consumer scrap, such as discarded electric cable, junked automobile radiators and air conditioners, or even ancient Egyptian plumbing! The remainder is new scrap, such as chips and turnings from screw machine production. Engineers hope that we will be able to use copper for centuries on.

**IV.** Say if the following statements are true or false. Correct the false statements.

1. Copper was extracted by man more than 10,000 years ago.
2. Copper alloys appeared because there was shortage of pure copper.

3. Copper metals are important functional and decorative materials today.
4. In the 19th century the demand for copper greatly decreased.
5. The resources of copper will be worked out in the near future.
6. If Egyptian plumbing is recycled a lot of copper can be obtained.

**V.** Agree or disagree with these statements. Give reasons for your answer.

1. Copper metals possess valuable properties.
2. Technological progress increases the demand for copper.
3. There is no need to save copper resources.
4. Copper can and should be recycled.

**VI.** Complete the diagram that classifies the following engineering materials. The diagram should have three levels.

alloys  
copper  
brass  
pure metals  
metals  
bronze  
tin

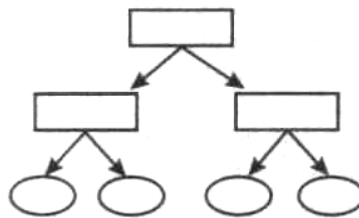

VII. Give a title to the text.

## Further Reading

I. These words are taken from the text. Use the dictionary to find out their meaning.

weathering, <i>n</i>	nuclear, <i>adj</i>
clad, <i>v</i>	nonsparking, <i>adj</i>
serviceable, <i>adj</i>	explosion, <i>n</i>
cookware, <i>n</i>	remain, <i>v</i>
jet plane, <i>n</i>	undamaged, <i>adj</i>

II. Do you know any interesting facts about copper? Share the interesting information with your group mates.

III. Read the text to learn more about properties and applications of copper.

## Do you know that...

...copper is essential to our health as an important constituent of skin, bones and blood. It is also biostatic - bacteria cannot grow on its surface. High-tech doctors save lives with the help of copper-clad scalpels.

...a copper plumbing system from the Pyramid of Cheops in Egypt is still in a serviceable condition after more than 5,000 years.

...copper has always been part of metal money.

...chefs around the world prefer copper cookware due to its properties of high heat transfer plus uniform heating (no hot spots).

...copper is the standard for electrical conductivity. It conducts electrical current better than any other metal except silver.

...IBM is replacing aluminium with copper in computer chips — up to 200 million transistors can be packed onto such a chip. The result is much faster operating speeds.

...about 2% (9,000 pounds) of the total weight of a Boeing 747-200 jet plane is copper. A typical diesel-electric locomotive uses about 11,000 pounds of copper while a Triton-class nuclear submarine uses about 200,000 pounds of copper.

...yellow brass (Copper Alloy 360) is so easy to machine, that it is the standard for metals machinability.

...high-strength, nonmagnetic and corrosion-resistant copper alloy tools are also nonsparking, which is valuable in situations where explosions are feared.

...designers look at copper and brass as metals of quality, comfort and beauty.

...through one hundred years of sea winds, rains and sun, the copper skin of the Statue of Liberty not only has become more beautiful but also has remained virtually undamaged. Closer analysis shows that weathering and oxidation of the copper skin has come to just 0.005 of an inch in a century.

...copper clearly was a good idea a hundred years ago. With technological advances, copper is still a great idea today.

### IV. Explain why ...

1)copper is important to our health.

2)copper is widely used in medicine.

3)the ancient Egyptian plumbing system is still in a serviceable condition.

4)copper cookware is preferred by cooks worldwide.

5)copper is the standard for electrical conductivity.

6)aluminium is being replaced with copper in computer chips.

- 7) transport means need copper.
- 8) copper alloy tools are used in situations where explosions are feared.
- 9) copper metals are popular as a decorative material.
- 10) the Statue of Liberty needed little restoration.

V. Comment on the following statement. Give reasons for your answer.  
 Copper metals are used for an infinite variety of applications that range from small mass-produced parts in free-machining brass to equipment for the 'space-age' industries of rocket production and atomic energy.

VI. Can you suggest another title for the text?

### Activity

I. a) Divide into groups and fill in the table using the information from the text and your background knowledge.

#### *Copper Metals*

<i>Area of Application</i>	<i>Example</i>	<i>Necessary Properties</i>
Medical Engineering	...	biostatic, corrosion-resistant
...		

b) Compare your results. Which group has the longest list?

II. You have been invited to a conference on the advances in Materials Science. Prepare a report on the topic "Present-day application of copper\*" and deliver it in class. Choose the most interesting one.

### Writing

I. Study the table (on page 216) and write a paragraph about the applications and properties of various copper alloys.



<i>Name</i>	<i>Metals present</i>	<i>Uses</i>
Aluminium bronze	Copper, aluminium	High tensile strength, can be cold-worked 01— cast, resistant to corrosion
Bell metal	Copper, tin (30%), lead	Casting bells
Brass	Copper, zinc	Cast and cold-worked in gears
Bronze	Copper, tin	general
Cupro-nickel	Copper, nickel (15-30%)	Very ductile, doesn't lose strength or crack when its shape is changed
Gunmetal	Copper, tin, zinc	Cast into gears, bearings
Phosphor bronze	Copper, tin, phosphorus (not a metal)	Cast to form gears and bearings where resistance to corrosion and wear is needed, as in sea water

II. Translate the passage into Russian. Use the dictionary if necessary.

Aluminium bronze is among the most varied and metallurgically interesting copper alloys. This metal is the first choice - and sometimes the only logical choice - for demanding applications owing to the exceptional mechanical and chemical qualities it offers, such as great strength, high hardness, excellent corrosion resistance (especially in seawater and similar environments), wear resistance and superior bearing qualities as well as favourable castability, machinability, ductability and nonmagnetic behaviour.

Evidently, all these properties are best applied where other materials can fail too soon or will be more expensive. Aluminium bronzes find widespread applications in petrochemical plants; power generation, aircraft, automotive, railway and marine engineering; in iron and steel making, electrical manufacturing and building industries.

## Section B. Steel

### Lead-in

I. Discuss the following questions.

- a) What is steel? Can you name the constituents of this alloy?
- b) Is steel widely used for engineering purposes? List all possible applications of steel.

II. Andrew has his practice at the steel works. Listen to his conversation with Alice and name the types and properties of steels that are mentioned by the students.

*Alice:* Hi, Andrew, where are you going in such a hurry?

*Andrew:* Oh, you see, I may not be late today. We are going to the Steel works.

*Alice:* Really? What will you do there?

*Andrew:* I don't know yet. Maybe this time we will be allowed to observe how iron is melted, purified and alloyed with other elements and steel is produced.

*Alice:* Have you been to this works before?

*Andrew:* Yes, last time we were allowed to work with carbon steels and alloy steels so we could study their properties.

*Alice:* And what have you found out?

*Andrew:* Well, many things. Do you know that the hardest, toughest, strongest and most valuable steel is tool steel?

*Alice:* I do now. Maybe you will be able to explain to me why stainless steel doesn't rust? I'm really interested.

*Andrew:* This is easy. Various alloying elements may be added to the base steel, which greatly improves its properties. Steel may be made corrosion-resistant if chromium is added.

*Alice:* I see... Well, see you tomorrow.

*Andrew:* OK. Bye-bye, then.

III. **That's** how we ask for and give permission in English. Study the table on page 218.

ASKING PERMISSION	GIVING PERMISSION
Can (may, could) ...?	You can/may if you want/like.
Is it all right if ...?	Yes, of course.
Do you mind if ... + <i>present simple</i> ?	Certainly.
Would you mind if ... + <i>past simple</i> ?	Go ahead.
	By all means.

IV. Complete the dialogues using the phrases for asking and giving permission.

a)- ...I have my practice at the British Steel works?

-...

b)- ...I observe the steel making process?

-...

c)- ...we study the properties of various types of steels today?

- ... . Later we'll discuss ... .

d) - What have you learnt...?

- Well, steels ... be classified ... types.

- OK, and ... the main properties of steels?

- Let's see. Steels are ... . Different... added to the base steel. This ... its properties a lot.

## Language Practice

### Vocabulary

I. Match the English words with their Russian equivalents.

- |                |                       |
|----------------|-----------------------|
| 1. hardness    | a. закалять           |
| 2. to cast     | b. твердость          |
| 3. pig iron    | c. легированная сталь |
| 4. malleable   | d-лить, отливать      |
| 5. to temper   | e. ковкий             |
| 6. alloy steel | f. передельный чугун  |

II. Find words formed from the first word in the line.

1. corrode - code, corrosive, charge, conductor
2. cast - substance, content, casting, steel

- 3.require- environment, requirement, refine, tempering
- 4.pure - sulphur, powerful, impurity, perform
- 5.metal - modern, meat, malleable, non-metal
- 6.considerable - carbon, constituent, construction, considerably

III. Make all possible word combinations.

to improve	furnace
molten	treatment
heat	steel
special	working
mechanical	application
electric	properties

### Grammar: The Modal Verb "may"

IV. Use the following statements in Past and Future.

EXAMPLE: He *may* continue the research.  
 He *was allowed to* continue the research.  
 He *will be allowed to* continue the research.

1. You may use carbon steel in the construction of this building.
2. She may extract iron from iron ores.
3. You may use manganese for changing properties of steels.
4. You may apply alloy steels for various engineering purposes.
5. The engineer may increase the carbon content of the steel.

V. Your partner is an Instructor in the lab. Ask him if you may perform the following actions. Work in pairs.

EXAMPLE: *to use these substances for the experiment*  
 A: May I use these substances for the experiment?  
 B: Yes, you may. You may use these substances for the experiment.

to elaborate the plan of the research  
 to experiment with alloying elements  
 to carry out different operations on milling machines  
 to demonstrate the properties of tool steels  
 to observe the steel making process

VI. Your friend wanted to do a lot of things in the practical class yesterday. Ask him if he was allowed to do all of them.

EXAMPLE: *to demonstrate the new applications of steels*

A: Were you allowed to demonstrate the new applications of steels?

B: No, I wasn't. But I will be allowed to do it tomorrow.

to work in the rolling mill

to test the performance characteristics of alloy steels

to use a new milling machine

to study the structure of stainless steels

to observe how steel is cast

VII. Discuss with your friend which of these things may be done.

EXAMPLE: *machine tools / to be made of pig iron*

A: May machine tools be made of pig iron? B: Certainly they may. They may be made of pig iron. or B: I'm afraid they may not. They may not be made of pig iron.

a) pure iron / to be refined

b) the properties of iron / to be modified easily

c) the carbon content of steel / to be varied

d) hydrogen / to be added to alloy steel

e) steel / to be tempered

f) steel alloys / to be protected from corrosion

g) steel / to be used for electrical wiring h) machine tools / to be made of pure iron

VIII. Insert the necessary prepositions.

1. I'm going to study the properties ... some materials.

2. Julia is interested ... elasticity.

3. Steel tools have grown ... popularity.

4. The student plans to carry ... his research on materials engineering.

5. We use metals ... different engineering purposes.

6. Steel may be pressed ... a new shape.

IX. Correct mistakes in the following sentences.

1. Metals which are used in industry may to be called engineering metals.

2. He wasn't allowed determine the constituents of this steel.

3. The majority of metals may to become harder after they have been cold-worked.
4. You doesn't may carry out the investigation here.
5. The students be allowed to practise in the rolling mill yesterday.
6. Will be I allowed to use the mobile equipment?

X. Translate the sentences into English using your active vocabulary.

1. Теперь вы можете исследовать свойства легированных сталей.
2. Вчера нам разрешили наблюдать, как очищают железо.
3. Скажите, пожалуйста, какие свойства имеет углеродистая сталь и почему она используется наиболее широко?
4. Могу я спросить: почему эта сталь не будет ржаветь?
5. Высокопрочные стальные сплавы могут включать разнообразные элементы.
6. Углеродистая сталь не может использоваться для изготовления шасси самолета.

## Reading and Speaking

I. Practise reading these words.

ancient ['emjant]	purify [pjunfai]
superior [sju:'piam]	percentage [pa'sentidʒ]
malleable ['maehabl]	ingot ['irjgat]

II. a) Today steels are used everywhere. How can you explain the popularity of this alloy?

b) Find in the text below the following information:

- 1) kinds of alloys;
- 2) constituents of steel;
- 3) how the qualities of steel may be changed;
- 4) alloying elements;
- 5) properties of alloy steels;
- 6) names of the technological processes that are mentioned.

III. Read the text attentively to learn more about steels.

The value of alloys was discovered in very ancient times; brass (copper and zinc) and bronze (copper and tin) were especially important. Today the most important are alloy steels, which have a lot of special characteristics.

Steel is known as an alloy of iron and about 2% or less carbon. Pure iron is soft, ductile and malleable, useful only as an ornamental material. However, the addition of carbon hardens it greatly and changes its properties. Steels for special applications may contain other alloying elements beside carbon. This modifies and improves the physical properties of the base steel. For example, small percentages of nickel, chromium, manganese and vanadium may be used for strengthening steels for construction work. Heat treatment (i.e. tempering) and mechanical working at cold or hot temperatures may also give steel alloys superior qualities, such as strength, hardness, toughness, wear resistance, corrosion resistance, electrical resistivity and workability.

Steel making processes are known as melting, purifying (refining) and alloying at **about 2,900 °F (1,600 °C)**. Molten steel may be first cast into ingots. Later ingots are worked into finished products. This may be done by two major methods: hot-working and cold-working. The latter is generally used for making bars, wire, tubes, sheets, and strips. Molten steel may also be cast directly into products.

IV. Choose the right option to complete the sentences.

1. Steel is a general name for
  - a) non-metals; b) ferrum; c) iron-and-carbon alloys.
2. Physical properties of iron may be modified greatly by the addition of
  - a) iron ore; b) hydrogen; c) carbon.
3. Pure iron is used
  - a) as an ornamental material; b) for construction work; c) in machine tools.
4. Steel for special applications usually contains
  - a) carbon; b) various alloying elements; c) vanadium.
5. Heat treatment and mechanical working at cold or hot temperatures result in ... of steel.
  - a) a different carbon content; b) better qualities; c) finished products.
6. Melting, purifying and alloying are the stages of steel
  - a) cold-working; b) refining; c) making.
7. Bars, wire, tubes, sheets, and strips are the result of
  - a) melting steel; b) hot-working; c) cold-working.

V. Today you have been given a lecture on steels. You have not understood it very well. Your friend is good at materials science. Ask him to explain to you clearly what steels are and how they are produced.

If you find the task too difficult, make up a list of the questions you are going to ask.

VI. What information have you received from the text? Is it useful? Where can you apply this information?

### Further Reading

I. Practise reading these words.

**average** ['ævərɪdʒ]

undercarriage ['ʌndə,kæridʒ]

tungsten ['tʌŋstən]

II. Look at the picture and try to guess what information the text may carry. Scan the text to check your answer. What does the text deal with?

III. Read the text attentively to learn more about various kinds of steel.

### Classes of Steel

Steels vary greatly but the major classes are carbon steels, low-alloy steels (up to 8% alloying elements, i.e. tool steels), and high-alloy steels (more than 8% alloying elements, i.e. stainless steels).

In carbon steels, the carbon content may range from 0.015% to 2%.

The steel that was used for the Golden Gate Bridge, for instance, is carbon steel with the following average chemical composition: C: 0.81% (0.85), Mn: 0.66%, P: 0.026% (0.04), S: 0.028% (0.04), Si: 0.24%. The addition of this tiny amount of carbon made the steel much stronger and harder. Carbon steels account for about 90% of the world's steel production. They may be used for automobile bodies, appliances, machinery, ships, containers, and the structures of buildings.

Tool steels are special steels that are engineered to particular service requirements. These expensive alloys are exceptionally strong, hard, wear-resistant, tough, nonreactive to local overheating. They contain tungsten, molybdenum, vanadium, and chromium in different combinations, and often cobalt or nickel for better high-temperature performance. They are used for machine tools, aircraft undercarriages, in buildings and bridges.





Stainless steels comprise any alloy steel that contains 10-30% chromium. The presence of chromium, together with the low carbon content, gives a remarkable resistance to corrosion and heat. Other elements, such as nickel, molybdenum, titanium, aluminum, niobium, copper, nitrogen, sulphur, phosphorus, and selenium, may be added for obtaining better corrosion resistance and other valuable properties.

IV. Can you read these chemical elements? If not, find their names in the text.

C, S, P, Se, W, Mo, V, Cr, Co, Ni, Ti, Al, Cu, N, Nb

V. Are these statements true or false? Correct the false statements.

1. There are many kinds of steels.
2. Three major classes are carbide steels, low-alloy steels, and high-alloy steels.
3. Carbon steel was used in building the Golden Gate Bridge.
4. Great strength, hardness and other valuable mechanical properties are obtained by the addition of a great amount of carbon.
5. Low-alloy steels are the most popular kind of steel.
6. Tool steel is used for producing automobile bodies, ships and spoons.
7. Tool steel is not cost-efficient.
8. Tungsten, molybdenum, vanadium, and chromium in different combinations may improve high-temperature performance of stainless steel.
9. A remarkable resistance of stainless steel to corrosion and heat is achieved with the help of chromium and high carbon content.

VI. Your friend studied the properties of different steels in the practical class. Ask him what he has found out.

These are the possible questions:

What types of steel did you study?

What is the carbon content of carbon steels? How does it influence their properties?

Where may carbon steels be used?

..... ?

## Activity

I. A group of students are on an excursion at the Steel works. Take them around and explain what they see starting from the value of alloys and finishing with making different types of steel.

II. You are a team of engineers who design various things.

a) Consider the advantages and disadvantages of various steels carefully.

<i>Class of Steel</i>	<i>Advantages</i>	<i>Disadvantages</i>
carbon steels	...	
tool steels	...	...
stainless steels	corrosion resistant	...

b) Decide which steels you will use for making the objects named below. Give your reasons.

Knives, nails, hammers, cables, automobile bodies, ships, containers, machine tools, aircraft undercarriages, bank vaults.

## Writing

I. a) Complete the table with the data you have obtained.

<i>Class of Steel</i>	<i>Composition</i>	<i>Properties</i>	<i>Use</i>
carbon steels	Fe, <b>C</b>	...	...
tool steels	Fe, C, Co, Ni, W, Mo, V, Cr	...	...
stainless steels	Fe, C, Ni, Mo, Ti, Al, Nb, Cu, N, S, P, Se, Cr	does not rust	...

b) Choose one type of steel and write its description.

II. Translate the passage into Russian. Use the dictionary if necessary.

Owing to the valuable properties of stainless steel its application may vary from spoons to bank vaults. This steel does not rust because of the interaction between its alloying elements and the environment. Stainless steel contains iron, chromium, manganese, silicon, carbon and significant amounts of nickel and molybdenum. These elements react with oxygen from water and air and produce a very thin stable film of metal oxides and hydroxides, which may prevent additional corrosion because it limits the access of oxygen and water to the metal layers below. This film may not be seen without a powerful microscope that is why steel seems stainless when it is in fact corroded at the atomic level.

In summary, stainless steel does not rust because it may form a corrosion product layer for the protection against further attacks of oxygen.

### *Section C. Composite Materials*

#### Lead-in

I. Discuss the following questions.

- a) Are plastics widely used today? Make a list of possible applications of plastics. Compare it with that of your group mates.
- b) What properties do plastics have?

II. Alice meets her friend Andrew in the University library. Listen to their dialogue and say what you have learnt about plastics.

*Alice:* Hi, Andrew, are you busy now?

*Andrew:* Yes, I am. I have to draw up a laboratory report. Can you help me do it properly?

*Alice:* Well, as far as I know, a laboratory report must contain the object of the experiment, the results that were obtained and the conclusions.

*Andrew:* And what about the procedure and the equipment? Must they be included into the report, too?

*Alice:* In my view, both of them must be included if you need a detailed report. By the way, Andrew, what did you have to determine during your experiment?

*Andrew:* We had to compare the properties of different plastics.

*Alice:* And what results did you get?

*Andrew:* Well, you know that plastics may be divided into thermoplastics and thermosetting plastics. So we have come to the conclusion that thermoplastics may be heated several times, while thermosetting plastics may be heated only once.

*Alice:* Oh, this is very interesting. And as far as I understand, this peculiarity of plastics must be taken into account when different engineering products are produced.

*Andrew:* Certainly. And I will have to prove it in my report.

### III. Complete the dialogue.

A- ....

B: Yes, I'm very busy. I have to draw up ... . Do you know how to do it properly?

A: ...

B: What do I have to do to draw up a laboratory report?

A: ...

B: And must the procedure and the equipment be included into the report, too?

A: ...

B: I had to determine the basic properties of thermoplastics.

A: ...

B: Certainly. It was very interesting.

A: ...

B: Oh, we will have to carry out another tensile test in a week.

A: Well, good luck to you.

### IV. Match a line in A with a line in B.

#### A

1. Hi, Andrew, you are busy now, aren't you?
2. What are you busy with?
3. What did you determine during the test?
4. How do thermosetting plastics differ from thermoplastics?
5. Good luck to you.
6. Could you tell me how to draw up the report properly?

#### B

- a) The hardness of polythene.
- b) Sorry, I'm very busy now.
- c) Well, yes.
- d) Thanks.
- e) I have to draw up a laboratory report.
- f) They can't be reheated.

# Language Practice

## Vocabulary

I. Match these words and expressions with their Russian translation.

- |                           |                                |
|---------------------------|--------------------------------|
| 1. thermoplastics         | a) слоистый материал           |
| 2. thermosetting plastics | b) стекловолокно c) полиэтилен |
| 3. glass fibre            | d) терморезистивные пластмассы |
| 4. carbon fibre           | e) ровный, гладкий             |
| 5. composite              | f) композиционный материал     |
| 6. phenolic resin         | g) анизотропный                |
| 7. polythene              | h) термопластические смолы     |
| 8. anisotropic            | i) феноло-альдегидный полимер  |
| 9. laminate               | j) углеволокно                 |
| 10. smooth                |                                |

II. Find in **B** the English equivalent to the Russian word in **A**.

<b>A</b>		<b>B</b>	
изменять	a) to modify	b) to cover	c) to replace
благодаря	a) because of	b) due to	c) thank you
достаточный	a) essential	b) sufficient	c) efficient
популярность	a) popular	b) popularity	c) famous
жёсткий	a) stiff	b) strong	c) soft
усиливать	a) to recycle	b) to enhance	c) to combine
улучшать	a) to increase	b) to improve	c) to introduce
преимущество	a) disadvantage	b) advantage	c) edge

III. Make up all possible word combinations.

materials	technology
sports	materials
glass-fibre	composites
water	absorption
plastics	industry
high-performance	ceramics

## Grammar: The Modal Verb "must"

IV. Say what these people must or mustn't do in these situations.

EXAMPLE: *engineers / to finish the test in half an hour*

The engineers must finish the test in half an hour.

or *engineers / to break safety instructions*

The engineers mustn't break safety instructions.

students / to attend classes

scientists / to perform all the experiments according to the instructions

students / to be late for their practical classes

friends / to help each other in difficult situations

students / to carry out a lot of experiments

engineers / to work with faulty devices

V. Ask your friend whether your group mates must do these things.

EXAMPLE: *to complete the test*

A: Must Alex complete the test?

B: No, he needn't, but Dima must.

to follow these instructions

to determine the strength of polythene

to study the advantages of polymers

to receive new data

to draw up a laboratory report

VI. Put these statements into Present, Past and Future using the modal verb *to have to* (*not to have to*) instead of *must* (*mustn't*).

EXAMPLE: *He must write a detailed report of the test.*

He has to write a detailed report of the test.

He had to write a detailed report of the test.

He will have to write a detailed report of the test,

1. The students must complete another series of experiments.

2. They must compare the results of two tests.

3. Alice must determine the composition of nylon.

4. The engineers must develop new plastics.

5. The scientist must elaborate the plan of his research.

VII. Ask your friend if he had to do the following things last week.

EXAMPLE: *to draw up a laboratory report*

A: Did you have to draw up a laboratory report last week?

B: No, I didn't. But I will have to draw up a laboratory report next week.

to study the influence of temperature on the strength of plastics

to describe the properties of bakelite

to compare the properties of phenolic resin and polythene

to do research on thermoplastics

to follow the procedure of the laboratory experiment

VIII. Ask your instructor if these things must be done.

EXAMPLE: *a detailed report of the experiment / to be written*

Student: Must a detailed report of the experiment be written?

Instructor: Certainly it must. It must be written without mistakes.

oil / to be used as a raw material for plastics

plastics / to be widely applied in construction work

plugs / to be made of phenolic resin

the conclusions / to be included in the report

the procedure of the experiment / to be described in detail

IX. Give advice to your friend in the following situations. Use the modal verb *should*.

EXAMPLE: A: *I have an examination tomorrow.*

B: Well, you should work very hard tonight.

1. I don't know how to draw up a report of my experiment.

2. I'm very tired after the practical class.

3. I'd like to know more about plastics.

4. I'd like to buy good sports equipment.

5. I want to become a materials engineer but I don't know what I must study and at what University.

X. Correct mistakes.

1. Denis hadn't to write a detailed report of the experiment with thermoses.

2. I will must to study all the peculiarities of this technological process next week.

3. He have to deliver a report on the applications of plastics.

4. I don't must switch on this machine without our teacher's permission.

5. Have you to recycle unwanted nylon?
6. Must be non-recycable plastics burnt?

XI. Translate the sentences using your active vocabulary.

1. Инженеры должны были модернизировать технологические процессы.
2. Мы должны будем составить доклад об эксперименте через неделю.
3. Пластмассы можно разделить на термореактивные пластмассы и термопластические смолы.
4. На занятии студенты должны будут определить прочность различных пластмасс.
5. Рабочие должны были, установить виниловые окна в здании.
6. Развитие науки о материалах должно привести к усовершенствованию многих инструментов, повышению их эффективности.

## Reading and Speaking

I. Do you like sports? Make a list of all possible materials that are used in sports equipment. Compare your list with that of your group mates.

II. Study the new words and word combinations.

pole vault	прыжок с шестом
to be fit	быть в хорошей форме
considerably	значительно
hickory	дерево гикоры ( <i>род североамериканского орешника</i> )

What do you think the text is about?

III. What materials are tennis rackets, hockey sticks and poles made of nowadays? Skim the text to find it out.

## Sports Materials

Materials engineering is the study of materials - anything from tennis racket frames to turbine blades in aero engines. The subject combines sciences with engineering and looks at the structure of materials, their properties and fabrication.

Materials science has a dramatic impact on sporting records. Since 1896 the Olympic record in the pole vault, for example, has increased from 3 to about 6 metres largely due to the changes in



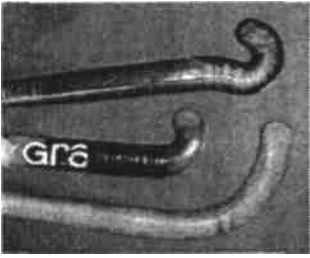

materials technology. The first poles were made from solid hickory wood. In 1904 bamboo poles were introduced, which only 50 years later were replaced by aluminium poles. The latter, however, gave little improvement in performance and had to be replaced by lighter and less stiff glass-fibre composites. These account for the dramatic increase in performance. The materials and design of hockey sticks have also changed a lot. Hockey sticks *used to be made*<sup>1</sup> from wood, and they failed quickly. Modern hockey sticks are made from carbon-fibre and glass-fibre composites, which increase stiffness. As the failure can be dangerous, researchers still have to improve the performance of composite sticks.

Early tennis rackets were made from solid wood (ash or maple). Because of its cellular structure, wood is anisotropic, i.e. its properties are not the same in each direction. This limited the size and stiffness of the rackets. The anisotropy was overcome by the introduction of wood laminates, but there was still the problem of water absorption, which caused the deformation of the racket. In the 1970s aluminium alloy frames were introduced. The greater stiffness of the aluminium meant that frames could be lighter. However, these were soon replaced by even stiffer and lighter carbon-fibre rackets. The research continues and materials engineers have not said their last word yet.

<sup>1</sup>раньше делали

IV. Choose the right option.

1. Since 1896 the Olympic record in the pole vault...
  - a) has decreased from 6 to 3 metres.
  - b) has increased from 3 to 7 metres.
  - c) has increased from 3 to 6 metres.
2. The poles used in 1896 were made from ...
  - a) bamboo.
  - b) hickory wood.
  - c) glass-fibre composites.
3. The performance in pole vaulting has increased greatly because ...
  - a) composite poles were made from aluminium.

- b) composite poles were lighter and less stiff.
- c) composite poles were made longer.
- 4. First hockey sticks were made from ...
  - a) wood.
  - b) carbon-fibre composites
  - c) carbon-fibre and glass-fibre composites.
- 5. Anisotropy is ... of solid wood rackets.
  - a) an advantage
  - b) a disadvantage
  - c) an improvement
- 6. In order to improve tennis rackets .... was introduced in the 1970s.
  - a) carbon-fibre composites
  - b) aluminium
  - c) solid wood

V. Complete the gaps with the words given below.

The materials technology has ... a lot over the past years. New more reliable materials have ... the old ones. Other advances in materials science may lead to further ... in performance. Let's have a look at some examples of sport... .

Poles are often ... from glass-fibre ... that increase their ... . Such poles are lighter and less ... than ... poles.

... and glass-fibre composites are also used for ... hockey sticks. This helps to ... stiffness. ..., such hockey sticks can be ... for players. That is why researchers are trying to ... their performance.

Carbon-fibre composites have also replaced aluminium in tennis .... Such composite rackets have a higher ... than aluminium ... , so rackets can be even stiffer and ... .

changed	performance	made	improvements	improve
equipment	carbon-fibre	replaced	aluminium	alloys
composites	producing	increase	dangerous	stiff
stiffness	lighter	rackets	however	

VI. The current rules state 'the pole may be of any material or combination of materials and of any length or diameter,, but the basic surface must be smooth". Look at the graph on page 234 and describe the influence of materials technology on the sporting records in the pole vault.

Graph showing the winning height in the pole vault at the Olympic Games since 1896.

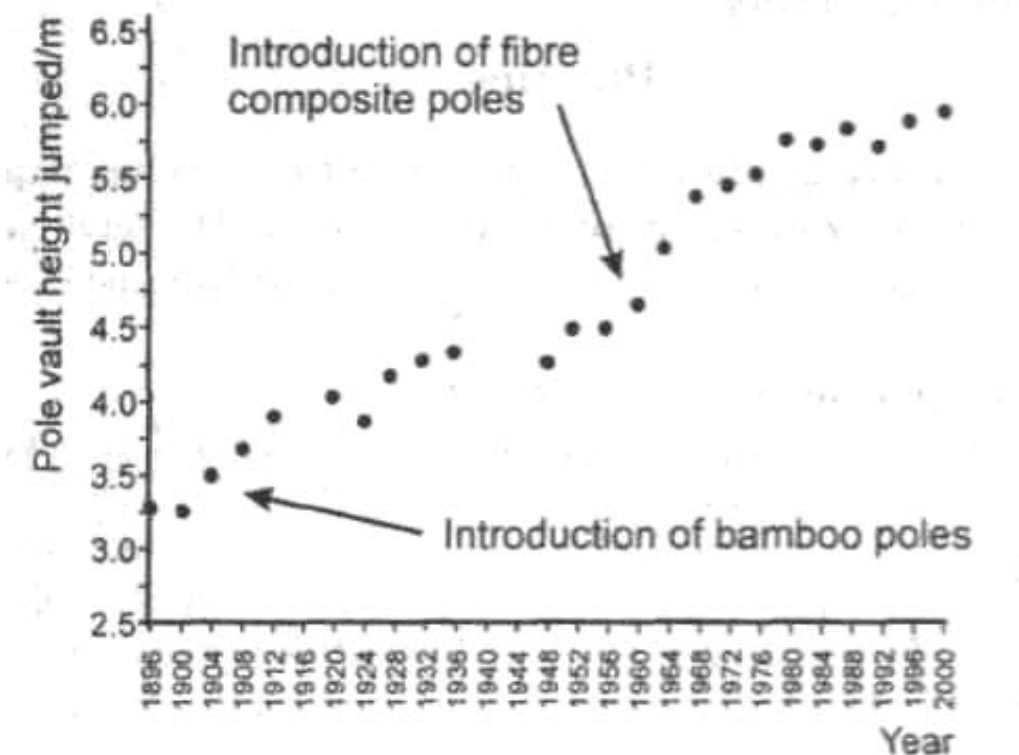

VII. You are in the shop 'Sport Master'. You want to buy a modern hockey stick and a good tennis racket. Discuss with the shop assistant the best choice.

### Further Reading

I. a) Practise reading these words.

polymer ['pəlimə]                      synthetic [sin'θetik]

celluloid ['seljʊlɪd]                    thermal ['θɜ:məl]

vulcanized

['vʌlkənaɪzd]

b) What can the text be about?

II. Skim the text to find answers to these questions.

1. What are the applications of plastics?

2. What is a polymer?

3. Are there any natural polymers?

4. What was the first synthetic polymer and when was it developed?

5. Do polymers possess valuable properties?

6. What is the disadvantage of plastics?

7. How can pollution by plastics be reduced?

III. Polymers influence all spheres of our life. They help health, safety and high performance possible. Read the text attentively for the detailed information about polymers.

### Plastics

Whether you are aware of it or not, plastics play an important part in your life. From the car you drive to work to the television you watch when you get home, plastics help make your life easier and better. How?

Plastics are polymers - long chains of many units that are usually made of carbon, hydrogen, oxygen, and/or silicon. Polymers have been with us since the beginning of time - tar, amber and horns are the easiest examples. In the 1800s these natural polymers were chemically modified and many materials such as vulcanized rubber and celluloid were produced. The first truly synthetic polymer Bakelite was developed in 1909 and was soon followed by the first synthetic fibre, rayon, in 1911.

Polymers come in a great variety of characteristics and colours. This fact alone must be considered as an advantage of these materials. They are cheaper and easier to make than, say, paper. Besides, polymers possess the properties of easy processing, durability, light weight, sufficient strength, thermal and electrical insulation and resistance to chemicals, corrosion and shock. These valuable qualities of polymers can be further enhanced by a wide range of additives, which broaden their uses and applications.

Unfortunately, we have to admit that plastics pollute the environment. Luckily, most polymers are thermoplastic (e.g. nylon, polythene), i.e. they can be heated and reformed again. The recycled plastics keep all their properties when they are combined with *virgin plastics*<sup>1</sup>. The other group of polymers, thermosets (e.g. bakelite, phenolic resin), must not be recycled, as reheating causes their deformation. However, the controlled incineration of thermosets converts waste into heat energy.

The usefulness of plastics can only be measured by our imagination. These are definitely the materials of past, present, and future generations.

<sup>1</sup> **пластмассы, которые ранее не перерабатывались**

III. Say if the following statements are true or false. Correct the false statements.

1. Plastics influence our life greatly.

2. Conventional polymer constituents include carbon, nitrogen, oxygen, and/or silicon.
3. Tar, amber and horns are the easiest examples of synthetic polymers.
4. Plastics both conserve and produce energy.
5. Polymers do not conduct electricity and heat.
6. All polymers are divided into two distinct groups: thermoplastics and thermosetting.
7. Unwanted thermoplastics should be recycled.
8. Bakelite and phenolic resin produce heat energy when they are incinerated.

V. Explain why the following things are made or covered with polymers. Name the properties of polymers, which are important in making these things.

<i>Product</i>	<i>Property</i>
plastic bottles for acids or cleaning fluids in your home electrical appliances, cables, electrical outlets and wiring microwave cookware and the handles of kitchen utensils car bodies, the frame structure of space stations portable phones and portable computers shopping plastic bags and packaging cups, plates, spoons and forks refrigerators and coolers picnic tables and fences decorations and toys bulletproof vests vinyl windows	light weight (as compared with paper or metal) sufficient strength thermal insulation electrical insulation resistance to chemicals resistance to corrosion easy processing energy and cost efficiency easy recycling resistance to shock

VI. Comment on the following statement.

"The usefulness of plastics can only be measured by our imagination. These are definitely the materials of past, present, and future generations."

## Activity

I. Nowadays professional sportsmen want to have high-quality sports equipment in order to win different competitions. That is why the Belarusian Olympic Committee has decided to buy modern equipment for our Belarusian sportsmen.

Divide into several groups.

Materials engineers: discuss what materials should be used in making the equipment for hockey players, tennis players and athletes. Present your ideas to the representatives of the Olympic Committee.

The Belarusian Olympic Committee: listen to the projects and choose the one you like most. Give your arguments.

II. Discussion. How much do we depend on plastics?

a) Read the following arguments and think of your own ones.

<i>We cannot live without plastics</i>	<i>We can live without plastics</i>
The soles of our shoes are made of plastics. The photographic film is made of it. ...	We can make leather shoes. ...

b) Discuss this problem in groups of 4 and make your own decision.

## Writing

I. Study the diagram on page 238 and write a paragraph about the applications of different types of plastics. Point out why these products are made of plastics.

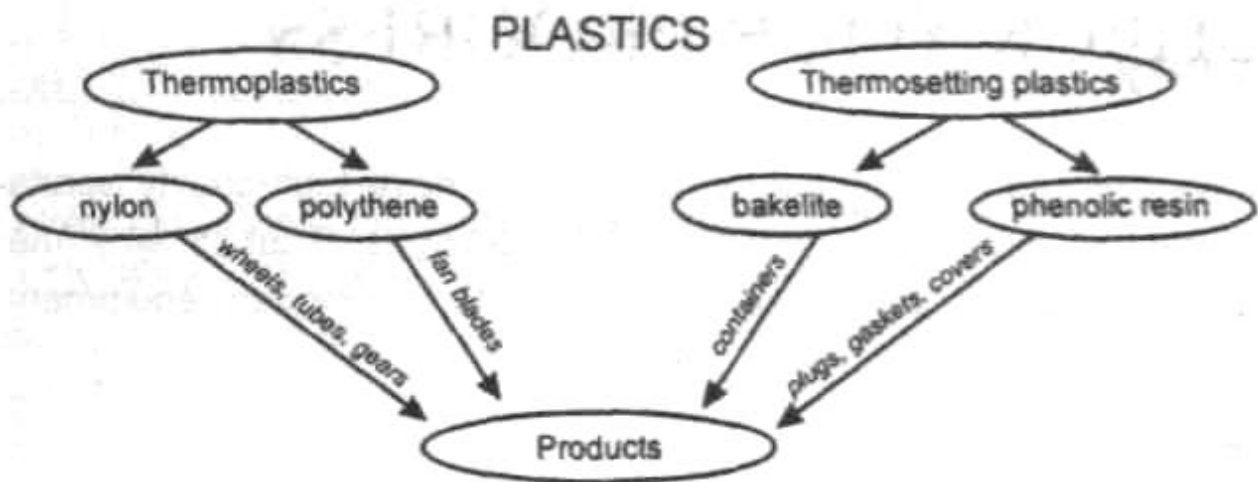

II. Translate the passage into Russian. Use the dictionary if necessary.

Despite well-grounded criticism, plastics possess numerous advantages. The most important of them is certainly energy conservation. Here are some simple examples.

Food must be kept fresh and healthy. In fact, each pound of plastic packaging reduces up to 1.7 pounds of food waste. Besides, plastics make packaging more efficient, which ultimately conserves resources. For example, you need 2 pounds of plastic for the delivery of 1,000 ounces of juice. You will have to use 3 pounds of aluminum, 8 pounds of steel or 27 pounds of glass for the same amount of juice. Plastics also help conserve energy in your home. Vinyl windows lower your heating and cooling bills. Plastic parts and insulation help major appliances - like refrigerators or dishwashers - resist corrosion, last longer and operate more efficiently. Indeed, their energy efficiency has improved by 50 percent since the 1970s. Health, safety, high performance - plastics help make these things possible.

## CHECK YOUR PROGRESS

1. Work in pairs. Choose the appropriate adverbial modifiers to complete the sentences. Do card A and your friend will do card B. Exchange your answers and check yourself.

### *Card A*

- |   |                        |
|---|------------------------|
| 1. The speedometer is indicating 3 kph.                           | sometimes              |
| 2. The computer processes pieces of information.                  | at this time           |
| 3. The scientists will describe the new computer technology.      | now                    |
| 4. They are testing a new calculating device.                     | by the end of the week |
| 5. The students will have learned some facts about robot history. | always                 |
| 6. The students perform a lot of experiments.                     | in half an hour        |
| 7. We'll be studying the properties of engineering materials.     | usually                |
| 8. He had designed a new model of a tractor.                      | from 10 till 12        |
| 9. We have mounted the tool in the manipulator.                   | by 5 o'clock           |
| 10. I will have seen a machining centre in operation.             | never                  |

### *Card B*

- |  |                               |
|--|-------------------------------|
| 1. Many requirements have been met.                                | long ago                      |
| 2. The new model had been equipped with up-to-date control filter. | recently                      |
| 3. He will have carried out field tests.                           | by next year                  |
| 4. The device had been repaired at our workshop.                   | usually                       |
| 5. The properties of new alloys will have been studied.            | next time                     |
| 6. Everything had been arranged.                                   | by the end of the day         |
| 7. This fuel was used in different engines.                        | lately                        |
| 8. The experiment was carried out.                                 | by 5 o'clock tomorrow         |
| 9. The device will be made of new engineering materials.           | by that time                  |
| 10. A new lathe will have been devised.                            | before the experiment started |



II. Complete the sentences with the words from the box. Pay attention to the tense form of these verbs.

1. The ammeter \_\_\_ +10 A at the moment.
2. The alternator \_\_\_ a strong or weak current for the engine.
3. The students \_\_\_ three types of electrical units.
4. John \_\_\_ small crocodile clips to make a good connection between the meter and resistor.
5. Computers \_\_\_ mathematical operations such as addition, subtraction and others.
6. The first computers\_ vacuum tubes and \_ thousands of calculations per second.
7. New generations of computers will more powerful.
8. The students \_\_\_ some facts about the history of computers.
9. After man \_\_\_ the robot he widened his possibilities and relieved himself from monotonous and hazardous tasks.
10. I already \_\_\_ the dimensions of the workpieces. Here they are.
11. What is it \_\_\_ of?
12. The students \_\_\_ an experiment yesterday.
13. The fuel \_\_\_ with air.
14. The workshop \_ with automatic machinery.
15. Most of the mini motor cars in Great Britain.
16. New motor vehicles will all customers requirements.

carry out	indicate	use (2)	
meet	produce (2)	measure	study
mix	invent	be	perform (2)
learn	make	equip	

III. Put in 'since', 'for', 'ago'.

1. We've studied robotics ... two years.
2. I've been in the lab ... 5 o'clock.
3. My friend graduated from the Technical University three years ...
4. She's been an engineer ... eighteen years.
5. Mary completed the experiment a few minutes ....
6. I haven't seen him ... weeks.

IV. Choose the right modal verb in these dialogues.

- a) - How ... I get to the Technical University (*can, may*)?  
- You ... go by bus or you ... walk (*can, may*).
- b) - ... I use this device tomorrow (*can, may*)?

- Of course, you ... (*can, may*).
- c) - ... I have a look at your results (*can, may*)?  
- Oh, yes. Here they are.
- d) - Why is he late?  
- He ... be busy, I'm not sure (*may, can*).
- e) - ... we start the experiment tomorrow? (*must, can*)  
- No, we ... (*can't, needn't*).

V. Translate these sentences using your active vocabulary.

1. На панели инструментов в автомобиле можно увидеть различные приборы, самый важные из них - спидометр, тахометр и амперметр.

2. Вчера на практическом занятии мы проводили эксперимент с мультиметром.

3. Современный компьютер представляет собой сложное электронное устройство, которое способно выполнять миллионы операций в секунду с огромной точностью. Компьютеры широко используются практически во всех областях промышленности.

4. Первый прототип робота был сконструирован еще в начале XX века. За последние годы, благодаря огромным достижениям в информатике и материаловедении, роботостроение значительно усовершенствовалось. Сегодня робот состоит из многочисленных манипуляторов, приводов, сенсоров и сложного программного обеспечения. Однако робота еще не научили думать.

5. Топливная система используется для подачи топлива в двигатель и состоит из бака, топливной трубки, насоса и карбюратора. В карбюраторе топливо смешивается с необходимым количеством воздуха. Затем эта смесь сжигается в камере сгорания и вырабатывается мощность.

6. Новые белорусские тракторы будут оснащены современными акустическими системами и фильтрами климатического контроля. Кроме этого, будут установлены галогенные фары на крыше кабины. Более того, современная кабина водителя обеспечит прекрасный обзор поля. Такие тракторы будут полностью соответствовать всем требованиям комфорта и безопасности.

VI. Rearrange the following lines to make up a dialogue of a telephone conversation between two students.

Paul  
- I'm fine. What are you doing now?  
- How are things with you?

Alice  
- Outside the exhibition hall.  
I'll be waiting for you.  
- Yes, I'd love to.

- Settled. I'll see you there then.
- Hello, is that you, Alice?
- Would you like to go to the computer exhibition?
- Where shall I meet you?

- OK. See you later.
- Not bad, thanks. What about you?
- Yes, I'm speaking.
- Well, at the moment I'm drawing up a laboratory report.

VII. Compare the pictures and say what has been changed in the car. Picture 1 shows a car in very bad condition, picture 2 shows the same car after repair.

Picture 1



1. the window screen / to be replaced
2. the engine / to be changed
3. the car / to be painted
4. the instrument panel / to be repaired
5. the tyres / to be pumped

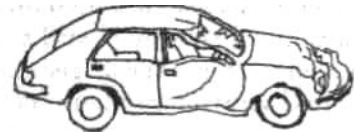

Picture 2

VIII. Look at this picture. This is how the author of the picture sees the future of our cars. Discuss with your partner what he wanted to say.

"Don't panic. The car's fully automated... The chauffeur's just to impress the neighbours."



- intelligent vehicle motion control
- automatic vehicle control
- ACC (adaptive cruise control)
- ABS (automatic braking systems)
- to adjust speed automatically
- to apply the brakes automatically
- to maintain vehicle stability and driver's safety

IX. a) Divide into two groups.

Group A: Read the text about temperature scales.

Group B: Read the text about barometers.

A: Four different scales are used for temperature measurement. The Fahrenheit scale divides the temperature between the freezing and boiling points of water into 212 units: that is, degrees. The Celsius scale (often called Centigrade) divides this same range of temperature into 100 degrees. The Kelvin scale begins its measurement at Absolute Zero with its degree intervals (intervals of temperature) corresponding to the Celsius scale - thus the freezing point of water on the Kelvin scale is **273.15°K**. The Rankin scale is also an Absolute Zero scale: however, its temperature intervals are based on the Fahrenheit rather than the Celsius scale.

B: A barometer is a meteorological instrument used for the measurement of atmospheric pressure. Barometers may be classified into two general types, depending on the ways in which they record the pressure of the atmosphere. The mercury barometer is the larger and more accurate of the two types, while aneroid barometer is more compact but less accurate.

The aneroid barometer is a portable meteorological instrument designed to record changes in atmospheric pressure.

The mercury barometer is a meteorological instrument used for measuring the pressure of the atmosphere in terms of the height of a column of mercury which exerts an equal pressure. In its simplest form it consists of a vertical glass tube about 80 cm. long, closed at the top and open at the lower end.

**b)** Find a partner from the other group and tell him what you've learnt from the text. Don't look back into the text.

**c)** Get back to your groups again and answer the comprehension questions.

Questions for Group A	Questions for Group B
1. What is a barometer?	1. How many scales are used for temperature measurement?
2. What are the general types of barometers?	2. What are they?
3. Which barometer is more accurate?	3. Which scale is divided into
4. What does the mercury barometer consist of?	4. What do the Rankin scale and the Kelvin scale have in common?

X. This text has been given to the students of the Technical University at the English Competition. They had only 45 minutes to translate it. Try your hand at it.

### Time's Arrow

People are born, grow up, grow old and die. Never the other way round. A star shines for billions of years as it converts vast stores of nuclear energy to heat and light that radiate out into the chilly emptiness of space. Time ticks on. The star runs out of fuel and its embers glow duller and colder - the energy it has radiated spreads ever farther into the universe. Just like the hot coffee on the desk in front of me, it is cooling down and the internal energy it once contained is spreading out. Everything cools down and energy spreads out. Time ticks on and the future is a cold, dark place. The past, on the other hand, was a hot, bright place, with a huge energy density - and the potential to do wonderful things. What's going on ...? Why is the future different from the past?

On the large scale, physical changes seem to proceed in one direction. They are irreversible. We do not see old people getting younger or cold coffee spontaneously reheating - the future really is different from the past and this difference is linked to irreversibility.

The future is different from the past because some changes are irreversible, but what we really want to know is why some things are irreversible and why this is only significant on the largest scale.

By the middle of the nineteenth century, physicists and engineers were intrigued by irreversible processes. They were particularly keen to understand why mechanical work can be converted to heat with 100% efficiency whilst the reverse process appears to be impossible. (Heat engines like the steam engine and internal combustion engine are designed to convert heat into work, so this question is highly significant.) This apparent irreversibility was raised to the status of a law - the second law of thermodynamics.

XI. How good is your memory? Here's a crossword for you to see how well you remember new words from the Units.

*Down:*

1. basic, fundamental, necessary
2. a degree of excellence
3. a material burnt as a source of energy
4. something that has been found by exploration. It is often a place or a scientific fact.
5. plastics belong to ....
6. movement, moving

- 7.a means of transport
- 8.a machine using fuel and supplying power
- 9.a machine programmed to move and perform certain tasks

*Across:*

- 10.a reddish-brown metallic element (symbol Cu)
- 11.a mixture of chemical elements at least one of which is a metal

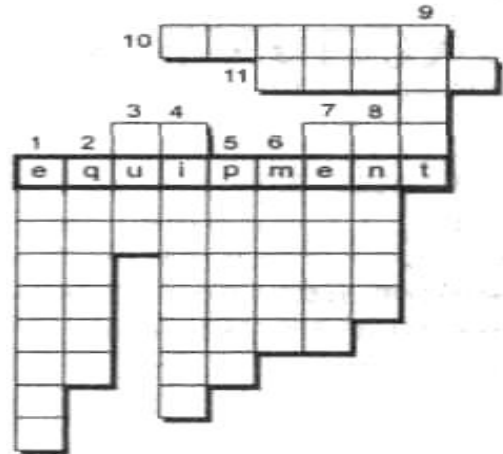

XII. When you apply for a job you will have to write an application. Study this example below and write your letter of application for the post you would like to have.

12 Skaryna Ave, apt 27  
Minsk, 220012  
21 April 2003

Belavtotrans  
12 Gurskaya st,  
Minsk, 220049

Dear Sir / Madam

I would like to apply for the post of Engineering Technician, which was advertised in today's issue of the *Business Week*. I enclose my CV for your attention.

You will note from my CV that I have a diploma with honours in Automobile Engineering and considerable experience. My work at the Motor Plant means that I am familiar with a wide range of steering and braking systems.

I enjoy my work at the Motor Plant but I would like now to broaden my experience, especially in the area of maintenance. I feel that I can bring considerable skill to the post together with the ability to work well in a team.

Please let me know if there is any further information you require. I look forward to hearing from you.

Yours faithfully  
Alexey Kosov



# ACTIVE VOCABULARY

## Unit 1

### Section A

accountant, n бухгалтер

architect, n архитектор

be, v **быть** to be afraid of sth

**бояться** чего-л.

to be good/bad at sth **хорошо/плохо разбираться в**

**чем-л.** to be tired of sth/ sb

**устать от** чего-л. /кого-л. to

be busy with sth **быть заня-**

**тым чем-л.**

to be surprised at sth **удив-**

**ляться** чему-л.

to be impressed by sth/sb

**быть под впечатлением от**

**чего-л./ кого-л.**

to be bored with sth/sb **ску-**

**чать от ...**

to be fed up with sth/sb **быть**

**сытым по горло от ...** to be

interested in **интересоваться**

...

to be fond of sth/sb **любить**

to be crazy about sth/sb

**сходить с ума по ...** to be

proud of **гордиться** to be

eager **сильно (очень,**

**страстно)желать** to be in the

1st (2nd, etc.) year **быть на**

**первом (втором ,...)** курсе

carpenter, n плотник

chemist, n химик

department, n факультет, отделение

correspondence department заочное

**отделение**

economist, n экономист

electrician, n электрик

engineer, n инженер

engineering, n техника, кон-

**струирование, строительство civil**

**engineering гражданское**

**строительство**

mechanical engineering маши-

**ностроение**

power engineering энергетическое

**строительство electrical**

**engineering электротехническое**

**строительство**

electronic engineering электроника

freshman, n первокурсник

graduate, n выпускник

joiner, n столяр

junior, n третьекурсник

mathematician, n математик

mechanic, n механик

metrologist, n метролог

physician, n терапевт

physicist, n **физик**

postgraduate, n магистрант,

**аспирант**

senior, n студент последнего курса

sophomore, n второкурсник

student, n студент

first- (second-) year student  
**первокурсник (второкурсник)**  
a full-time (part-time) student  
**студент дневного (заочного, вечернего) отделения** technician,  
n **техник** technologist, n **технолог**  
undergraduate, n **студент, уча-**  
**щийся в университете**

### Section B

acute, adj **острый**  
angle, n **угол**  
chisel, n **долото, стамеска**  
curve, n **кривая**  
full, adj **полный**  
glasses, n **очки**  
goggles, n **защитные очки**  
line, n **линия**  
nail, n **гвоздь**  
nut, n **гайка**  
obtuse, adj **тупой**  
parallel, adj **параллельный**  
pincers, n **клещи**  
pipe, n **груба**  
plane, n **плоскость**  
pliers, n **плоскогубцы**  
right, adj **прямой**  
ruler, n **линейка**  
scissors, n **ножницы**  
screw, n **винт, шуруп**  
screwdriver, n **отвертка**  
spanner, n **гаечный ключ**  
square, n, adj **квадрат,**  
**квадратный** straight, adj  
**прямой** tool, n **инструмент**  
tyre, n **шина** wheel, n  
**колесо**

## Unit 2

### Section A

circle, n **круг, окружность**  
circular, adj **круглый**  
equal, adj **равный**  
plug, n **штепсель**  
rectangle, n **прямоугольник**  
rectangular, adj **прямоугольный**  
round, adj **круглый**  
ruler, n **линейка**  
shape, n **форма**  
side, n **сторона**  
socket, n **розетка**  
square, n, adj **площадь,**  
**квадрат; квадратный**  
triangle, n **треугольник**  
triangular, adj **треугольный**

### Section B

approximately, adv **приблизи-**  
**тельно** area, n **площадь** cubic, adj  
**кубический** deep, adj **глубокий**  
depth, n **глубина** dimension, n  
**размер** ft (foot, feet) **фут, футы**  
height, n **высота** high, adj  
**высокий** in (inch) **дюйм** length, n  
**длина** long, adj **длинный**  
measurement, n **измерение**  
narrow, adj **узкий** thick, adj  
**толстый** thickness, n **толщина**  
volume, n **объем**



wide, adj **широкий**  
width, n **ширина**

### *Unit 3*

#### Section A

adjust, v **регулировать; настраивать; устанавливать**  
always, adv **всегда**  
bit, n **сверло**  
brush, n **кисть**  
chisel, n, v, **долото, стамеска; работать долотом, стамеской**  
concrete, n **бетон**  
drill, n, v **дрель, сверло; сверлить**  
drive, v **приводить в движение, вести машину**  
dry, adj **сухой**  
file, n **напильник**  
grind, v **шлифовать, полировать**  
guard, n **ограждение, защитное устройство**  
hammer, n **молоток**  
hammer, v **вбивать (гвозди) молотком**  
mains, n **сеть (электрическая, водопроводная)**  
mark, n, v **знак, отметка; размечать, отмечать**  
measure, v **измерять**  
never, adv **никогда**  
press, v **прижимать, нажимать**  
pull, v **тянуть, тащить**  
remove, v **отодвигать, убирать, перемещать**  
safety-notice, n **инструкция по технике безопасности**  
saw, n, v **пила; пилить**  
shelf, n **полка**  
spread, v **наносить на поверхность; сверлить**

stone, n **камень**  
tighten, v **закреплять**  
tool, n **инструмент**  
toolboard, n **доска для инструментов**  
toolbox, n **ящик для инструментов**  
twist, v **крутить, скручивать**  
vice, n **тиски**  
wire, n **провода**  
workbench, n **верстак**  
workpiece, n **обрабатываемая деталь, заготовка**  
workshop, n **мастерская**

#### Section B

blade, n **лезвие**  
car, n **автомобиль, машина**  
diesel, n **дизельное топливо**  
difference, n **различие, отличие**  
engine, n **двигатель**  
air-cooled engine **двигатель с воздушным охлаждением**  
water-cooled engine **двигатель с водяным охлаждением**  
fan, n **вентилятор; тягодутьевое устройство**  
four-cylinder, adj **четырёхцилиндровый**  
four-stroke, adj **четырёхтактный**  
fuel, n **топливо**  
handle, n **рукоятка, ручка**  
headlight, n **передняя фара**  
injector, n **форсунка**  
jack, n **передвижное подъёмное приспособление; домкрат**  
ladder, n **лестница, стремянка**  
lid, n **крышка**  
motorcycle, n **мотоцикл**

oil, n **масло** oil sump **маслосборник**  
petrol, n **бензин**  
pump, n **насос**  
radiator, n **радиатор**  
sidelight, n **поворотный сигнал,**  
**боковой фонарь**  
spare, adj **запасной, свободный,**  
**лишний**  
spare parts **запасные части**  
spark, n **искра** spark plug **свеча**  
**зажигания**  
steering wheel **рулевое колесо**  
two-cylinder, adj **двухцилиндровый**  
two-stroke, adj **двухтактный**  
type, n **тип, вид**  
valve, n **клапан**  
vehicle, n **транспортное средство**  
windscreen, n **лобовое стекло**  
wipers, n **дворники (в автомобиле)**

#### *Unit 4*

#### Section A

back, n **задняя сторона, обратная**  
**сторона** at the back **сзади, позади**  
camshaft, n **распределительный вал**  
crankshaft, n **коленчатый вал**  
device, n **прибор**  
few, adj **мало** a few, adj  
**немного**  
front, n **передняя сторона** at the  
front **спереди**  
lorry, n **грузовик**  
many, adj **много**  
middle, n **середина**

in the middle **посередине** mixed  
**смешанный** mixture, n **смесь**  
fuel mixture **топливная смесь**  
motor, n, adj **автомобиль,**  
**двигатель; автомобильный,**  
**двигательный**  
motor vehicle **автомобиль,**  
**автотранспортное средство** some,  
adj, pron **некоторый,**  
**несколько (часто не**  
**переводится)** stroke, n

**ход, такт**

induction stroke **ход впуска,**  
**такт впуска**  
compression stroke **ход**  
**сжатия, такт сжатия**  
power stroke **рабочий ход,**  
**рабочий такт**  
exhaust stroke **ход выпуска,**  
**такт выпуска**

#### Section B

alloy, n **сплав**  
aluminium, n **алюминий**  
bucket, n **ковш, черпак, поршень**  
can, n **канистра, бидон, банка**  
carbon, n **углерод**  
cement, n **цемент**  
copper, n **медь**  
gravel, n **гравий**  
hydrogen, n **водород**  
iron, n **железо** cast iron  
**чугун**  
kerosene, n **керосин**  
little, adj **мало** a little  
**немного**  
much, **много**  
nickel, n **никель**  
reservoir, n **резервуар, бассейн**

rubber, n **каучук, резина** sand, n **песок** steel, n **сталь** sulphur, n **сера**  
tank, n **бак, цистерна**  
fuel tank **топливный бак** vessel, n **резервуар, баллон** zinc, n **цинк**

### *Unit 5*

#### Section A

ammeter, n **амперметр**  
calculator, n **калькулятор**  
current, n **ток**  
cut, v **резать**  
drive in, v **забивать, вбивать, вколачивать**  
gauge, n **измерительное устройство, измерительный прибор**  
indicate, v **указывать; показывать, обозначать**  
instrument, n **измерительный прибор, инструмент**  
liquid, n **жидкость**  
manometer, n **манометр**  
micrometer, n **микрометр**  
microscope, n **микроскоп**  
operation, n **операция**  
perform, v **выполнить**  
pointer, n **стрелка**  
pressure, n **давление**  
protect, v **защищать**  
scale, n **шкала**  
speed, n **скорость**  
speedometer, n **спидометр**  
tachometer, n **тахометр**  
thermometer, n **термометр**  
use, v **использовать**

#### Section B

beam, n **пучок** calculate, v **считать**  
distance, n **расстояние** equipment, n **оборудование** function, n **функция**  
instead of, prep **вместо** laser, n **лазер**  
lens, n **линза** light, n **свет** power, n **энергия**  
powerful, adj **мощный**  
produce, v **получать, производить**  
pyrometer, n **пирометр** scales, n **весы**  
source, n **источник** weight, n **вес**

### *Unit 6*

#### Section A

beaker, n **мензурка, колба, химический стакан**  
beam, n **балка, брус**  
ceramics, n **керамика, гончарное производство**  
conductivity, n **проводимость, удельная проводимость** electric conductivity **электропроводимость**  
heat conductivity **теплопроводимость**  
fabrication, n **изготовление, производство**  
ferrous, adj **черный, не цветной (о металле)**  
glass, n, adj **стекло; стеклянный**  
machine-building, n **машиностроение**

manganese, n марганец  
material, n материал  
metal, n металл  
non-ferrous, adj цветной  
non-metal, n неметалл  
plastic, n, adj пластмасса, пластик;  
пластмассовый  
plasticity, n пластичность  
resistance, n сопротивление corrosion  
resistance коррозиестойчивость  
rod, n брус, рейка  
rubber, n резина, каучук  
silicon, n кремний  
widely, adv широко be widely used  
широко использоваться  
wood, n дерево  
wooden, adj деревянный  
Section B  
application, n применение  
brittle, adj хрупкий, ломкий  
elastic, adj эластичный  
expensive, adj дорогой  
flexible, adj гибкий, эластичный,  
мягкий  
hard, adj твердый  
heavy, adj тяжелый  
light, adj легкий  
product, n продукт, изделие  
engineering product техническое  
изделие  
property, n свойство  
rigid, adj жесткий, устойчивый  
soft, adj мягкий  
therefore поэтому, следовательно  
tough, adj жесткий, прочный  
valuable, adj ценный

## Unit 7

### Section A

also, adv также  
alternator, n генератор переменного  
тока  
although, adv хотя  
as так как  
axis (axes, *pi*), n ось horizontal axis  
горизонтальная ось  
vertical axis вертикальная ось  
charge, v заряжать(ся) recharge, v  
перезаряжаться), повторно заряжать  
discharge, v разряжаться(ся)  
choose, v выбирать  
draw, v рисовать, чертить  
enough, adv достаточно  
evenly, adv равномерно, одинаково  
fast, adj, adv быстрый; быстро, часто  
graph, n график, диаграмма  
indication, n показание  
investigate, v изучать, исследовать  
label, v пометать, отмечать  
move, v двигать(ся),  
передвигать(ся)  
number, v нумеровать  
operate, v приводить(ся) в движение,  
управлять(ся), работать  
operation, n работа; *mat.* действие,  
(технологическая) операция  
panel, n панель  
record, v записывать, реги-  
стрировать

repair, v **чинить**  
slowly, adv **медленно**  
solve, v **решать** to solve problems  
**решать примеры**  
strong, adj **сильный**  
turn, v **вращать(ся)**  
variable, n **переменная (величина)**  
dependent variable **зависимая**  
**переменная**  
independent variable **независимая**  
**переменная**

### Section B

accelerate, v **разгонять, ускоряться**  
amount, n **величина, количество**  
carry out, v **выполнять, проводить**  
circuit, n **цепь**  
clip, n **зажим, клемма** crocodile clips  
**зажимы типа "крокодил"**  
conductor, n **проводник**  
connect, v **соединять**  
decrease, v **уменьшать(ся)**  
definite, adj **определенный**  
determine, v **определять**  
electricity, n **электричество**  
flow, v, n **течь; поток**  
increase, v **увеличивать(ся)**  
lead, n **провод**  
look for, v **искать**  
multimeter, n **мультиметр**  
observe, v **наблюдать**  
prepare for, v **готовиться к**  
probe, n **щуп**  
range, n **диапазон, интервал, предел**

resistance range **диапазон**  
**(изменения)сопротивления**  
relationship, n **отношение** resistance, n  
**сопротивление** switch **переключатель**  
switch function selector **переключатель**  
**функций** unit, n **элемент, единица**  
value, n **значение, величина,**  
**показатель, число** voltage, n  
**напряжение**

### Unit 8

### Section A

accept, v **принимать; допускать,**  
**признавать, соглашаться**  
access **доступ** to have access to **иметь**  
**доступ к**  
according to, prep **согласно, в**  
**соответствии с**  
accurately, adv **точно**  
add, v **складывать**  
available, adj **доступный; имеющийся**  
**в распоряжении**  
calculation, n **вычисление** to do  
calculations **производить вычисления**  
calculating machine **устройство для**  
**вычислений**  
communicate, v **сообщать,**  
**передавать; общаться**  
compile, v **компилировать** compile  
a programme **составлять**  
**программу**  
CPU (Central Processing Unit)  
**центральный процессор**  
data **данные, факты, информация**  
decision, n **решение** to make a decision  
**принимать решение**

define, v определять, устанавливать значение  
display, v, n выводить данные на экран; дисплей  
divide into, v делить  
drive, n дисковод  
dull, adj скучный; монотонный  
embrace, v включать, заключать в себе, содержать  
employ, v применять, использовать  
encoding, n кодирование  
fail, v повреждаться, выходить из строя, отказывать  
floppy, n гибкий (магнитный) диск  
floppy disc гибкий диск  
hardware, n аппаратное обеспечение  
input, n ввод  
keyboard, n клавиатура  
make up, v составлять, комплектовать  
memory, n память  
mouse, n мышь (*устройство указания*)  
multiply, v умножать  
network, n вычислительная сеть, сеть  
output, n вывод  
owing to, prep по причине, вследствие, благодаря  
peripheral, n, adj периферийное устройство; периферийный  
permanent, adj постоянный, неизменный, долговременный  
powerful, adj сильный, могучий, мощный  
precisely, adv точно  
primarily, adv прежде всего, главным образом

process, v обрабатывать to process information обрабатывать информацию  
processor, n процессор  
remain, v оставаться, пребывать в прежнем состоянии  
replace, v заменять, замещать  
screen, n экран  
software, n программное обеспечение  
storage, n запоминание; хранение (информации) storage device устройство хранения информации  
store, v хранить  
subtract, v вычитать  
supply, v, n поставлять, доставлять, давать; поставка  
transmit, v отправлять, посылать, передавать  
user, n пользователь  
with the help of с помощью

## Section B

advantage, n преимущество  
basic, adj основной  
branch, n отрасль, ветвь branch of industry отрасль промышленности  
branch of science отрасль науки  
capability, n возможность, способность  
capable, adj способный, возможный  
come out, v выходить, появляться  
concept, n понятие, идея, общее представление, концепция  
consume, v потреблять, расходовать

contain, v **вмещать, содержать в себе**  
count, v **подсчитывать, считать**  
deal with, v **рассматривать вопрос, иметь дело (с чем-л.)**  
depend on, v **зависеть (от)**  
develop, v **развивать, разрабатывать, создавать** development, n **развитие**  
devise, v **создавать, разрабатывать**  
disadvantage, n **недостаток**  
frame, n **рама, корпус**  
general-purpose, adj **универсальный**  
generation, n **поколение**  
go on doing smth, v **продолжать делать что-либо**  
improve, v **улучшать**  
in comparison with, prep **в сравнении с**  
intelligent, adj **умный**  
invent, v **изобретать, создавать** invent the abacus **изобрести счеты**  
invention, n **изобретение**  
inventor, n **изобретатель**  
link, v, n **связывать, соединять; связь, соединение**  
occupy, v **занимать (пространство)**  
power, n **способность, возможность, мощность**  
reduce, v **уменьшать, снижать** reduce possibility **уменьшить вероятность**  
remarkable, adj **замечательный, удивительный**  
save, v **сохранять, беречь, спасать** save time **экономить время**  
task, n **задание**

## Unit 9

### Section A

actuate, v **приводить в действие; запускать; включать**  
actuator, n **привод, исполнительный механизм**  
advance, n **успех, прогресс, улучшение**  
although, adv **хотя**  
apply, v **применять, употреблять**  
bend, v **сгибать(ся), изгибать, гнуть**  
capacity, n **возможность**  
carry» v **нести, перемещать, переносить**  
cause, v **вызывать, приводить к чему-л.**  
complex, adj **сложный, трудный**  
create, v **создавать**  
degree, n **степень**  
discover, v **открывать**  
discovery, n **открытие**  
essential, adj **необходимый, важный**  
even, adv **даже**  
experience, n **опыт работы**  
extend, v **увеличиваться), растягивать(ся)**  
field, n **сфера, область (исследования, применения)** in the field of **в области**  
force, n **сила, усилие**  
gear, n **механизм, устройство, прибор**  
industrial, adj **промышленный**  
manipulator, n **манипулятор**  
muscle, n **мускул, мышца**  
pick up, v **поднимать, подбирать**

place, v, n помещать, устанавливать;  
место, пространство  
plant, n завод, фабрика  
production, n производство,  
изготовление, продукция production  
line производственная линия,  
технологическая линия  
provide, v предоставлять,  
обеспечивать  
recently, adv недавно  
reduce, v уменьшать, снижать  
robotics, n=robot engineering  
роботостроение, робототех-  
ническая промышленность  
sequence, n серия, последова-  
тельность, ряд sequence of operations  
серия операций  
series, n ряд, серия  
spring, v, n пружинить; пружина  
straighten, v выпрямлять, разгибать  
stretch, v растягивать(ся), натягивать  
Section B  
achieve, v достигать achievement, n  
достижение begin, v начинать certain,  
adj определённый consist of, v  
состоять из effector, n  
исполнительный  
орган  
end effector рабочий орган  
{робота} efficient, adj эффективный,  
действенный finish, v  
заканчивать

grip, n, v, захват, захватное  
устройство; захватывать gripping  
device захватное устройство  
handle, v справляться, выполнять  
hazardous, adj опасный  
install, v устанавливать, монтировать  
to install equipment устанавливать  
оборудование  
monotonous, adj монотонный  
motion, n движение  
put, v положить; приводить to put into  
operation приводить в действие  
relieve, v облегчать, ослаблять,  
уменьшать  
repetitive, adj без конца  
повторяющийся, скучный  
research, n исследование; изучение;  
изыскание to carry out reseach  
выпол- -нять, проводить изыскания  
reseach work исследовательская  
работа  
sensor, n датчик; чувствительный  
элемент, сенсор  
start, v начинать  
switch on, v включать  
switch off, v выключать  
widen, v расширять(ся) to widen one's  
possibilities расширить возможности

## Unit 10

### Section A

accelerator, n акселератор,  
ускоритель



brake, n тормоз, тормозное устройство  
brakes (*pi*) тормозная система  
burn, v гореть, сгорать  
carburettor, n карбюратор  
chamber, n камера; отсек; отделение  
combustion chamber камера сгорания  
chassis, n ['Jaesi]-smg, ['Jaesiz]-p/ шасси  
combustion, n сгорание, сжигание  
• internal combustion engine двигатель внутреннего сгорания  
compose, n составлять  
compress, v сжимать, подвергать сжатию  
drive, v, n вести, управлять; приводить в движение; привод, передача  
equip, v оборудовать, оснащать  
feed, v поддерживать; снабжать (*топливом, водой, сырьём*), питать  
gear, n передача, шестерня  
ignite, v возгорать(ся); зажигаться  
intake, n поступление, приток; впускное устройство air intake воздухозаборник  
locate, v размещать, располагать  
mix, v смешивать; перемешивать  
piston, n поршень  
pump, n насос fuel pump топливный насос  
refer to, v относиться к  
separate, adj отдельный

situated, adj расположенный be situated располагаться  
steering, n рулевое управление  
suspension, n подвеска independent suspension независимая подвеска  
system, n система; комплекс, установка  
automatic braking system система автоматического торможения  
fuel system топливная система  
lubrication system система смазки  
cooling system система охлаждения  
tank, n бак; цистерна fuel tank топливный бак  
venturi, n трубка Вентури

## Section B

adjust, v настраивать, регулировать  
arise, v возникать, появляться  
attention, n внимание pay attention to обращать внимание на  
comfortable, adj удобный, комфортабельный, уютный  
considerably, adv значительно  
construct, v строить, сооружать, конструировать  
design, v, n проектировать, разрабатывать, конструировать; проект, разработка, конструкция  
detect, v обнаруживать  
distance, n расстояние  
ensure, v обеспечивать, гарантировать

feature, n признак, свойство,  
характерная особенность,  
характерная черта  
feed, v подавать, питать, снабжать  
gasoline, n бензин  
gearbox, n коробка передач, коробка  
скоростей  
highway, n магистраль automated  
highway автоматизированная  
магистраль  
in time, adj вовремя  
introduce, v внедрять, вводить  
monitor, v контролировать, управлять  
passenger, n пассажир  
place, v, n помещать; размещать;  
место, пространство  
power, v снабжать энергией,  
приводить в действие  
respond, v реагировать, срабатывать  
space, n место, пространство  
stability, n стабильность,  
устойчивость, стойкость,  
прочность  
steam, n пар  
successful, adj успешный, удачный  
unless, prep если не, пока не  
workload, n нагрузка

## Unit 11

### Section A

acoustic, adj акустический acoustic  
system акустическая система  
cab, n кабина  
cleanliness, n очистка  
condition, n условие under good  
condition при хо-

роших условиях  
control, n контроль, система  
управления, рычаг управления  
demand, v, n требовать; требование  
due to, prep благодаря  
enable, v давать возможность  
enhance, v увеличивать, повышать  
exist, v существовать  
filter, n фильтр oil filter маслофильтр  
climate control filter фильтр  
климатического контроля  
flat, adj плоский  
illustrate, v иллюстрировать,  
пояснять  
incorporate, v внедрять, вводить,  
устанавливать  
involve, v включать в себя  
level, n уровень  
light, n свет, фара work light  
фара  
maintain, v обслуживать, содержать в  
исправности, поддерживать в  
хорошем состоянии  
manufacture, v производить,  
изготавливать, обрабатывать  
mount, v устанавливать, собирать,  
монтировать, крепить  
noise, n шум  
opportunity, n возможность  
outstanding, adj выдающийся,  
знаменитый  
performance, n производительность,  
функционирование, эффективность  
productivity, n продуктивность,  
производительность  
protect against, v защищать от  
purpose, n цель

quality, n **качество** high quality **высокое качество** low quality **низкое качество**  
refinement, n **улучшение, (у) совершенствование**  
reliable, adj **надежный**  
require, v **требовать**  
requirement, n **требование** to meet requirements **соответствовать требованиям**  
*specifications, n* **технические характеристики**  
time-consuming, adj **отнимающий много времени**  
torque, n **вращающий момент, крутящий момент**  
transmission, n **привод, коробка передач, трансмиссия**  
truck, n **грузовой автомобиль, (грузовая) тележка**  
trust, v **доверять**  
wear, n **износ**  
works, n **завод**

## Section B

casing, n **кожух, чехол, корпус**  
changer, n **переключатель, механизм смены (инструментов, валков и т. п.)**  
fixture, n **приспособление, арматура**  
lathe, n **токарный станок**  
machine, n **станок** cylindrical machine **цилиндрический станок** prismatic machine **призматический станок**  
milling machine **фрезерный станок**  
drilling machine **сверлильный станок, бурильная машина**

grinding machine **шлифовальный станок, заточный станок**  
boring machine **расточный станок, сверлильный станок, бурильная машина** multi-purpose machine **многоцелевой станок** machining centre **многоцелевой станок**  
numerical control **числовое программное управление, ЧПУ**  
computer numerical control (CNC) **ЧПУ типа CNC** direct numerical control (DNC) **станок с централизованным программным управлением**  
remove, v **удалять, снимать**  
shape, v **формировать, придавать форму**  
simultaneously, adv **одновременно**  
tool, n **орудие (производства); инструмент**  
hand tool **ручной инструмент**  
machine tool **станочная (автоматизированная) система** cutting tool **режущий инструмент, резец** metal-cutting tool **металлорежущий инструмент**

## Unit 12

### Section A

ability, n **способность; возможность**  
able, adj **способный, умелый, умеющий**

to be able to уметь, мочь, быть в состоянии / в силах  
alloy, v сплавлять, легировать  
annually, adv ежегодно  
appliance, n электроприбор domestic appliances предметы домашнего обихода  
brass, n латунь, жёлтая медь  
bronze, n бронза  
constituent, n составная часть, компонент  
decoration, n отделка, украшение  
ductile ковкий, тягучий; вязкий (о металле)  
estimate, v оценивать  
evidence, n свидетельство  
except, prep исключая, кроме  
extract, v извлекать  
functional, adj конструктивный, без украшательства  
heat, n тепло, теплота  
lead, n свинец  
machine, v обрабатывать на машине или станке  
mine, v разрабатывать, добывать  
ore, n руда copper ore медная руда  
plumbing, n водопроводно-канализационная сеть  
pure, adj чистый, беспримесный  
rate, n скорость, степень  
recover, v восстанавливать  
recycling, n повторное использование, утилизация  
resource, n ресурс; *мн.* запасы  
run out, v истощаться, кончаться  
scrap, n отходы  
surface, n поверхность  
tin, n олово

tremendous, adj огромный, громадный  
turnings, n (*pi*) токарная стружка  
uniform, adj единообразный, однообразный, однородный  
workability, n способность подвергаться обработке

## Section B

account for, v объяснять, отвечать, являться причиной  
add, v добавлять, присоединять  
beside, prep кроме, помимо  
cast, v лить, отливать  
chromium, n хром  
comprise, v включать, содержать, состоять из  
content, n содержание, доля  
corrode, v ржаветь; подвергаться действию коррозии  
especially, adv особенно, главным образом  
exceptionally, adv исключительно, крайне  
furnace, n печь  
harden, v закалывать(ся), повышать прочность; твердеть  
ingot, n слиток, чушка  
iron, n железо, чугун pig iron передельный чугун, чушковый чугун  
malleable, adj ковкий; тягучий  
melt, v расплавлять(ся), плавить(ся)  
modify, v видоизменять, модифицировать  
ornamental, adj декоративный  
particular, adj особый

percentage, n процентное со-  
держание  
purify, v очищать(ся)  
range from ... to..., v колебаться в  
пределах от... до...  
refine, v улучшать, (усовер-  
шенствовать)  
resistivity, n (электрическое)  
удельное сопротивление  
rust, v ржаветь  
steel, n сталь alloy steel  
легированная сталь  
carbon steel углеродная сталь tool  
steel инструментальная сталь  
stainless steel нержавеющая сталь  
molten steel расплавленная сталь  
strength, n прочность  
strengthen, v усиливать, упрочнять  
superior, adj лучший, превосходный,  
высшего качества  
temper, v закалять  
treat, v подвергать (техноло-  
гической) обработке, обра-  
батывать  
work, v обрабатывать  
working, n обработка

### Section C

absorption, n поглощение account, n  
внимание, расчёт to take into account  
принимать во внимание additive, n  
добавка, примесь anisotropic, adj  
анизотропный bakelite, n бакелит  
cause, v вызывать

chain, n цепь, цепочка  
characteristic, n характерная черта,  
особенность, свойство  
combine, v объединять, сочетать  
compare, v сравнивать  
composite, n композиционный  
материал  
conclusion, n вывод, заключение  
convert, v превращать, переделывать  
define, v определять  
detailed, adj детальный, подробный,  
обстоятельный  
draw up, v составлять (документ),  
оформлять  
durability, n прочность; стойкость;  
долговечность  
fabrication, n изготовление, сборка  
fail, v провалиться, потерпеть неудачу  
failure, n авария, повреждение,  
неудача, провал  
fibre, n волокно glass fibre  
стекловолокно carbon fibre  
углеволокно  
impact, n воздействие, влияние  
incineration, n сжигание (отходов)  
include, v включать, содержать  
insulation, n изоляция  
keep, v сохранять  
laminate, n слоистый материал  
limit, v устанавливать предел,  
ограничивать  
material, n материал  
materials engineering материа-  
ловедение

nylon, n **нейлон**  
object, n **объект** (*изучения и т. п.*),  
**задача**  
obtain, v **получать, приобретать**  
peculiarity, n **характерная черта,**  
**особенность**  
plastics, n **пластмассы** thermosetting  
plastics **термореактивные**  
**пластмассы** thermoplastics  
**термопластические смолы**  
polymer, n **полимер**  
polythene, n **полиэтилен**  
procedure, n **процедура, процесс**

properly, adv **должным образом; как**  
**следует; правильно** prove, v  
**доказывать** report, n **отчет** resin, n  
**полимер, смола** phenolic resin **феноло-**  
**альдегидный полимер** shock, n **удар,**  
**толчок** smooth, adj **ровный, гладкий**  
solid, adj, n **твердый; твердое**  
**тело** stiff, adj **негнувшийся, жёсткий**  
sufficient, adj **достаточный** synthetic,  
adj **синтетический** while, cj **пока, в то**  
**время как**

# GRAMMAR

## Unit 1

*to be*

The verb *to be* has the following forms in Present Simple.

### Positive

I	am	a student.
He She It	is	
We You The	are	students.

### Negative

I	am not ( 'm not)	a student.
He She It	is not (isn't)	
We You They	are not (aren't)	students.

### Questions

Am	I	a student?
Is	he she it	
Are	we you they	students?

### Word Order

0. Place, time    1. Subject    2. Verb/Predicate    3. Object    4. Place, time  
 1. Now    we    are students at    the University  
 2.    The students    are fond of    English.

*Pronouns*

Personal		Possessive
Subject	Object	
I	me	my
You	you	your
He	him	his
She	her	her
It	it	its
We	us	our
You	you	your
They	them	their

Demonstrative	
Singular	Plural
This is a wheel.	These are wheels.
That is a wheel.	Those are wheels.

EXAMPLES:  
 He is an architect.  
 I'm glad to meet him.  
 This is his wife.

*Unit 2*

Remember the following:

What shape is it?	It is triangular.
	It is a triangle.
	It has three equal angles.

What is the <u>length</u> of the table?	How <u>long</u> is the table?
The <u>length</u> of the table is 1 m.	The table is 1m <u>long</u> .

I You We They	have	a PC (personal computer).
He She It	has	a CD (compact disc).



*Questions*

Do	I you we they	have	a PC?
Does	he she it		a CD?

EXAMPLES:  
I have a car.  
He has a motorbike.

*Unit3*

Remember the following construction:

Singular	Plural
Where is the instrument?	Where <u>are</u> the instruments?
<u>It is</u> in the box.	<u>They are</u> in the box.

*There is / There are*

a)

	There is	not	a ruler on the table.
	There is		
Is	there		a ruler on the table?

b)

	There are	not	rulers on the table.
	There are		
Are	there		rulers on the table?

c) Remember the structure of such questions: How many rulers are there on the table?

*Prepositions*

near                      above on  
                                 ↓ in                      ↓                      at  
                                 below  
                                 under

## Degrees of Comparison

### Comparatives of one-syllable adjectives (regular)

Positive	Comparative	Superlative
	... + er	... + est
long	longer	the longest
wide	wider	the widest
big	bigger	the biggest
busy	busier	the busiest

### Irregular comparison

Positive	Comparative	Superlative
good	better	the best
bad	worse	the worst
much / many	more	the most
little	less	the least

EXAMPLES: This pipe is short. This pipe is shorter than that pipe. This is the shortest pipe in the workshop.

## Unit 4

### Expressions of Quantity: many / (a) few, much / (a) little

	Countable Nouns	Uncountable Nouns
the quantity is large ( <b>МНОГО</b> )	many, a lot of wheels	much, a lot of fuel
the quantity is small but enough ( <b>НЕМНОГО</b> )	a few wheels	a little fuel
the quantity is too small, not enough ( <b>МАЛО</b> )	few wheels	little fuel

EXAMPLES: There are many nails in the toolbox.  
 There are a few nails in the toolbox. Take some.  
 There are few nails in the toolbox. Bring some more.  
 There is much cement in the box.  
 There is a little cement in the box. That's enough.  
 There's little cement in the box. I need some more.

*Indefinite Pronouns "some /any / no*

some	positive	There is some petrol in the tank.
no	negative	There are no tools on the table.
(not) any	negative	There aren't any cars on the road.
any	question	Are there any computers in the classroom?

Remember the word order in the following questions: Do you happen to know what engine it is? Could you tell me where the Technical University is?

*Unit 5*

Remember the following constructions:

What is it called?	It is called a ruler. It is known as a ruler.
What is it for? What is used for?	It is for measuring length. It is used for measuring length.

*Unit 6*

Remember the following constructions:

It is made of metal.				
	Is	it	made of	metal?
What	is	it	made of?	
What material	is	it	made of?	
Why	is	it	made of	metal?

*Comparatives of Longer Adjectives (two/ three/ four syllables)*

Positive	Comparative	Superlative
...	<i>more + ...</i>	<i>the most + ...</i>
powerful	more powerful	the most powerful
expensive	more expensive	the most expensive
elastic	more elastic	the most elastic

Positive	Comparative	Superlative
...	<i>less + ...</i>	<i>the least + ...</i>
practical	less practical	the least practical
difficult	less difficult	the least difficult
busy	less busy	the least busy

Unit 7

*Present Progressive (Active)*

*Positive*

I	am	studying.
He She It	is	
We You They	are	

*Negative*

I	am not (m not)	studying?
He She It	is not (isn't)	
Are	are not (aren't)	

*Questions*

Am	I	studying?
Is	he she it	
Are	we you they	

*It is used to express*

- 1) progressive actions that are going on now, at the moment of speaking.  
I am measuring pressure right now.
- 2) progressive actions that are going on around now, not necessarily exactly at the moment of speaking.  
I am studying Physics this semester at the University.

*Specific time expressions*

right now, at the moment, today, this week, this month, this year, nowadays

### *Past Progressive (Active)*

*Positive*

*Negative*

I He She It	was	working.
We You They	were	

I He She It	was not (wasn't)	working
We You They	were not (weren't)	

*Questions*

Was	I he she it	working?
Were	we you they	

*It is used to express* an action that was in progress at a specific time in the past.

Dima was reading a textbook at 7 o'clock yesterday.

*Specific time expressions*

at that time, at 6pm yesterday, the whole day, yesterday, from 3 to 5 o'clock yesterday

## *Future Progressive (Active)*

*Positive*

*Negative*

I	will be	watching.
You		
He		
She		
It		
We		
They	/	"

I	will not be (won't	watching.
You		
He		
She		
It		
We		
They		

*Questions*

Will	I you he she it we they	be watching?
------	---	-----------------

*It is used* to express an activity that will be in progress at a specific time in the future.  
I'll be working in the lab at 2 tomorrow.

*Specific time expressions*

at 5 o'clock tomorrow, from 2 to 3 tomorrow, at this time tomorrow, the whole day tomorrow

## *Unit 8*

*Present Simple (Active)*

*Positive*

*Negative*

I	perform carry out	different experiments.
You		
We		
They		
He	performs carries out	
She		
It		

I	do not	perform carry out	different experiments.
You			
We			
They			
He	does not		
She			
It			

## *Questions*

Do	I you we they	perform carry out	different experiments?
Does	he she it		

- 1) to state general facts in the present  
I live in Minsk. I study at the Technical University.
- 2) to state general rules or laws of nature  
Water boils at 100 °C.
- 3) to express habitual actions, regular routines  
My classes at the University usually begin at 8am.

### *Specific time expressions*

every day (month, year, ...), in the morning, usually, often, always, sometimes, seldom, rarely, on Sunday, at the weekend, as a rule, etc.

### *Past Simple (Active)*

*Positive*

*Negative*

I	invented a computer. made a
You	
He	
She	
We	
They	

I	did not invent a computer. make
You	
He	
She	
We	
They	

## *Questions*

Did	I you he she it we they	invent make	a computer? a discovery?
-----	---	----------------	-----------------------------

*It is used to express*

1) a completed action

He compiled a programme yesterday.

2) past habits or actions repeated in the past

When he was in school he often thought about becoming an engineer.

*Specific time expressions*

yesterday, the day before yesterday, last year (month, ...), in 1995, a year ago, etc.

*Future Simple (Active)*

*Negative*

*Positive*

I		
You		
He		
She	will	buy a
It		
We		
The		

I	will not	buy a
You	(won't)	computer.
He		
She		
We		
They		

*Questions*

Will	I	buy a
	you	computer?
	he	
	she	
	it	

*It is used to express*

1) a future act

The students will take their exams in June.

2) a future intention

I will call you tomorrow.

*Specific time expressions*

tomorrow, next week (year, ...), in September, in 2010, in a few days, etc.



Unit 9

Present Perfect (Active)

Positive

I You We They	have (ve)	done performed	an experiment.
He She It	has Cs)		

Negative

I You We They	have not (haven't)	done performed	an experiment.
He She It	has not (hasn't)		

Questions

Have	I you we they	done performed	an experiment?
Has	he she it		

*It is used to express*

- 1) an action that completed in the past but we are interested in its present result.  
I have visited many countries and I can tell you a lot about them.
- 2) an action that began in the past but is still going on in the present.  
I have worked as an engineer for 10 years.

*Specific time expressions*

just, already, yet, never, ever, lately, recently, since, for 2 years, etc.

*Past Perfect (Active)*

*Positive*

I You He She It We They	had (d)	prepared done	the homework.
---	---------	---------------	---------------

*Negative*

I You We They	had not (hadn't)	done	the homework.
He She It		prepared	

*Questions*

Had	I you he she it we they	done prepared	the homework?
-----	---	------------------	---------------

*It is used* to express an action in the past that happened before another action in the past or by some specific time in the past.

We had completed the test by 5 o'clock yesterday.

He had written a report before I called him.

*Specific time expressions*

by 2 o'clock yesterday, by the end of the year (week,...) before + Past Simple, etc.

*Future Perfect (Active)*

*Positive*

*Negative*

I	will have tested the
You	
He	
She	
It	
We	
They	

I	will not (won't) have tested the device.
You	
He	
She	
It	
We	
They	

*Questions*

Will	I you he she .. we they	have tested the device?  - -
------	---	------------------------------------

*It is used to express a future action that will be completed before another future action or by a certain time in the future.*

I will have finished the experiment by 5 o'clock tomorrow.

She will have prepared the necessary equipment before we begin the experiment.

*Specific time expressions*

by 2 o'clock tomorrow, by the end of the next year, before + + Present Simple, etc.

*Unit 10*

*The Passive Voice*

A passive verb indicates that the subject of the sentence did not perform the action of the verb. It shows that someone or something else performed this action.

EXAMPLE: The Statue of Liberty was designed by a French engineer.  
= A French engineer designed the Statue of Liberty.

*Present, Past and Future Simple Passive*

Present		Past		Future	
am	constructed built	was	constructed built	shall be	constructed built
is		were		will be	
are					

- EXAMPLES: 1. Students are taught different subjects at the University.  
 2. The first robot was designed in the 20th century.  
 3. New cars will be designed in the future.

*Unit 11*

*Present, Past, Future Perfect Passive*

Present			Past			Future			
have	been	constructed	had	been	constructe	will	have	been	constructe
has		built			d built				d built

- EXAMPLES: 1. A new chemical element has been discovered lately.  
 2. This road had been repaired by the time you came here.  
 3. The data will have been processed by the end of the day.

*Unit 12*

*Modal Verbs*

*Can*

The modal verb can often has the meaning of ability, opportunity or permission to the verb.

	Positive	Negative	Question
Present	I can drive.	I can't drive.	Can you drive?
Past	I could drive.	I couldn't drive.	Could you drive?
Future	-	-	-

- EXAMPLES: 1. He can compile difficult programmes, (*ability*)  
 2. At the Technical University students can get good knowledge in all spheres of engineering, (*opportunity*)  
 3. You can take this device now. (*permission*)

Another expression that shows ability is be able to. It has the following forms:

Present		Past		Future	
am	able to drive	was	able to drive	will be	able to drive
is		were			
are					

- EXAMPLES: 1. He is able to charge this battery.  
 2. We'll be able to manufacture the new device.  
 3. He was able to solve the problem.

*May*

The modal verb may often has the meaning of possibility and permission.

	Positive	Negative	Questio
Present	You may	You may not	May I
Past	-	-	-
Future	-	-	-

- EXAMPLES: 1. We may study the properties of metals at today's lesson, (possibility)  
 2. May I take that instrument? - Of course, *you may* (*permission*)

Another expression that shows permission is be allowed to. It has the following forms:

Present		Past		Future	
am	allowed to go	was	allowed to go	will be	allowed to go
is		were			
are					

- EXAMPLES: 1. You are allowed to borrow the book.  
 2. He was allowed to test the machine.  
 3. We will be allowed to experiment with different metals.

## *Must/Have to*

The modal verb must has the meaning of necessity and obligation.

	Positive	Negative	Question
Present	I must	I mustn't	Must I
Past	-	-	-
Future	-	-	-

EXAMPLES: 1. We must drive to our work, (*necessity*)

2. All students must attend this lecture, (*obligation*)

Another expression with the same meaning is have to.

	Present	Past	Future
Positive	I have He has	had to work.	I will have to work.
Negative	„ , „ <b>have to</b> work. He doesn't	didn't have to	I will not have to
Question	„ , „ have to work? Does he	Did I have to	Will you have to

EXAMPLES: 1. We didn't have to complete all the tests yesterday.

2. She will have to demonstrate the new machine tomorrow.

Remember the following structures:

1. You mustn't cross the road here. (=Don't cross it.)

2. You don't have to do it today. (=It is not necessary to do it today. You don't need to do it)

Modal verbs can also be used with Passive verbs.

Remember:

can be done may be must be built
--

## APPENDIX 1

### *Most Frequently Used Abbreviations*

A, a	- ampere <b>ампер</b>
ac	- alternating current <b>переменный ток</b>
a-hr	- ampere-hour <b>ампер/час</b>
C	- degree centigrade <b>градус Цельсия</b>
dc	- direct current <b>прямой ток</b>
dm.	- decimetre <b>дециметр</b>
e.g.	- exempli gratia-for example <b>например</b>
<i>g</i>	- gram <b>грамм</b>
hi-fi	- high fidelity <b>высокая точность звуковоспроизведения</b>
h.p.	- horsepower <b>лошадиная сила</b>
Hz	- hertz <b>герц</b>
i.e.	- id est = that is <b>то есть</b>
J	- joule <b>джоуль</b>
kg	- kilogram <b>килограмм</b>
kW	- kilowatt <b>киловатт</b>
kW-hr	- kilowatt-hour <b>киловатт/час</b>
lb.	- (Lat. libra) pound <b>фунт</b>
lit.	- litre <b>литр</b>
m	- metre <b>метр</b>
m	- milli- <b>милли-</b>
mi	- mile <b>миля</b>
min.	- minute <b>минута</b>
No.; Nos	- number(s) <b>номер(-а)</b>
pc, pes	- piece(s) <b>штука(-и)</b>
ppm - parts per million	- <b>частей на миллион</b>
psf	- pounds per square foot <b>фунтов на кв. фут</b>
psi	- pounds per square inch <b>фунтов на кв. дюйм</b>
Qty	- quantity <b>количество</b>
rpm	- revolutions per minute <b>оборотов в минуту</b>
rps	- revolutions per second <b>оборотов в секунду</b>
sc.	- scale <b>шкала</b>
sec	- second <b>секунда</b>
t	- ton <b>тонна</b>
V	- volt <b>вольт</b>
W, w	- watt <b>ватт</b>
yd.	- yard <b>ярд</b>

APPENDIX 2  
*Units of Measurement*  
Linear Measures

Дюйм	inch	in.	2.54 cm
Фут	foot	ft (12 in.)	30.48 cm
Ярд	yard	yd (3 ft)	91.44 cm
Миля	mile	mi. (1760 yd)	1609,33 m
Миля морская	nautical mile	naut.mi. (6080 ft) (knot)	1853,18 m

Measures of Weights

Драхма	dram	dr.	1,77g
Унция	ounce	oz(16or.)	28.35 g
Фунт	pound	lb. (16 lz)	453.59 g
Стон	stone	st. (14 lb.)	6.35 kg
Квартер	quarter	qr(281b.)	12.7 kg
Центнер	hundre	hwt(1121b.)	50.8 kg
Тонна большая	weight ton	t (20 hwt)	1016.048 kg

Measures of Volume

Джилл	gill	-	0.141
Пинта	pint	pt (4 gills)	0.571
Кварта	quart	qt(2pt)	1.141
Галлон	gallon	gal. (4 qt)	4.55 1
Бушель	bushel	bsh. (8 gal.)	36.371
Квортер	quarter	qr (8 bsh.)	290.941
Кв. ДЮЙМ	Square Measures		sq.in.
square	6.45 cm <sup>2</sup>		
inch	sq.ft (144 sq.yd)	9.29	dm <sup>2</sup>
Кв. фут	square	sq.yd (9 sq.ft)	0.836
foot			m <sup>2</sup>
Кв. ярд	square	ac. (4840 sq.yd)	0.4 hectare
yard			2.59
Акр	acre		km <sup>2</sup>
Кв. МИЛЯ	' square	sq.mi. (640 ac.)	259
mile			hectares



## Cubic Measures

Куб. дюйм	cubic inch	c.in.	16.39 cm <sup>3</sup>
Куб. фут	cubic foot	eft (1728 c.in.)	0.028 m <sup>3</sup>
Куб. ярд	cubic yard	c.yd(27c.ft)	0.76 m <sup>3</sup>
Тонна регистравая	register ton	reg.t. (100 eft)	2.33 m <sup>3</sup>

## APPENDIX 3

### *Conjunctions 1. Сочинительные союзы*

and - и, а  
as well as - так же как, а также  
both... and - и ... и; как ... так  
not only but also - не только ..., ной ...  
but - но, а  
or - или, иначе  
either ... or - или ... или; либо ... либо  
neither ... nor - ни ... ни

### *3. Подчинительные союзы*

#### а) времени:

after - после того как  
as - в то время как; когда; по мере того как  
as long as - пока; до тех пор пока  
as soon as - как только  
before - перед тем как  
since - с тех пор как; после того как  
till, until - до тех пор пока ... не  
while - в то время как

#### б) причины:

as - так как  
because - потому что; так как  
since - так как, поскольку

#### в) условия:

if - если  
provided - при условии, если  
unless - для того чтобы, чтобы

г) цели:

in order to - для того чтобы, чтобы

д) образа действия:

as - как

as if - как будто; как если бы so ... that - так

(такой)... что such ... that - такой ... что

е) сравнения:

as ... as - такой же ... как; так ... как

not so ... as - не так ... как; не такой ... как

than - чем

ж) следствия:

so that - так что

в) уступительные:

in spite of - несмотря на то, что though (although) - хотя

since - поскольку

## APPENDIX 4

### *List of Irregular Verbs*

Infinitive	<i>Past Simple</i>	<i>Past Participle</i>	Infinitive	<i>Past Simple</i>	<i>Past Participle</i>
be	was/were	been	come	came	come
beat	beat	beaten	cost	cost	cost
become	became	become	cut	cut	cut
begin	began	begun	deal	dealt	dealt
bend	bent	bent	dig	dug	dug
bet	bet	bet	do	did	done
bite	bit	biten	draw	drew	drawn
blow	blew	blown	drink	drank	drunk
break	broke	broken	drive	drove	driven
bring	brought	brought	eat	ate	eaten
build	built	built	fall	fell	fallen
burst	burst	burst	feed	fed	fed
buy	bought	bought	feel	felt	felt
catch	caught	caught	fight	fought	fought
choose	chose	chosen	find	found	found

Infinitive	Past <i>Simple</i>	<i>Past participle</i>	Infinitive	Pas* <i>Simple</i>	<i>Past participle</i>
fly	flew	flown	send	sent	sent
forbid	forbade	forbidden	set	set	set
forget	forgot	forgotten	sew	sewed	sewn/sewed
forgive	forgave	forgiven	shake	shook	shaken
freeze	froze	frozen	shine	shone	shone
get	got	got	shoot	shot	shot
give	gave	given	show	showed	shown
go	went	gone	shrink	shrank	shrunk
grow	grew	grown	shut	shut	shut
hang	hung	hung	sing	sang	sung
have	had	had	sink	sank	sunk
hear	heard	heard	sit	sat	sat
hide	hid	hidden	sleep	slept	slept
hit	hit	hit	speak	spoke	spoken
hold	held	held	spend	spent	spent
hurt	hurt	hurt	split	split	split
keep	kept	kept	spread	spread	spread
know	knew	known	spring	sprang	sprung
lay	laid	laid	stand	stood	stood
lead	led	led	steal	stole	stolen
leave	left	left	stick	stuck	stuck
lend	lent	lent	sting	stung	stung
let	let	let	stink	stank	stunk
lie	lay	lain	strike	struck	struck
light	lit	lit	swear	swore	sworn
lose	lost	lost	sweep	swept	swept
make	made	made	swim	swam	swum
mean	meant	meant	swing	swung	swung
meet	met	met	take	took	taken
pay	paid	paid	teach	taught	taught
put	put	put	tear	tore	torn
read/ri:d/	read/red/	read/red/	tell	told	told
ride	rode	ridden	think	thought	thought
ring	rang	rung	throw	threw	thrown
rise	rose	risen	understand	understood	understood
run	ran	run	wake	woke	woken
say	said	said	wear	wore	worn
see	saw	seen	win	won	won
seek	sought	sought	wind	wound	wound
sell	sold	sold	write	wrote	written

## APPENDIX 5

### *Spelling*

1. Words ending in -y (baby, carry, easy, etc.)

If a word ends in a *consonant* + **y** (-by/-ry/-sy. etc.):

**y** changes to *ie* before -s:

country/countries                      apply/applies

lorry/lorries    study/studies        try/tries

**y** changes to *i* before -ed:

hurry/hurried    study/studied        apply/applied        try/tried

**y** changes to *i* before -er and -est:

easy / easier / easiest

heavy / heavier / heaviest

**y** changes to *i* before -ly:

easy/easily        heavy/heavily        temporary/temporarily

**y** does *not* change before -ing:

studying    applying    trying    employing    **y** does *not* change if the word ends in a *vowel* + **y** (-ay/-ey/-oy/uy):

enjoy/enjoys/enjoyed    play/plays/played    alloy/alloys    *Note:* say/said  
pay/paid    lay/laid

2. Verbs ending in -ie (die, lie, tie) If a verb ends in -ie, *ie* changes

to **y** before -ing: lie/lying    die/dying

3. Words ending in -e (smoke, hope, wide, etc.)

Verbs

produce /producing        use / using    move /moving

Exceptions: be/being

Verbs ending in -**ee**:    see/seeing    agree/agreeing

produce /produced    use / used    move /moved

Adjectives and adverbs

wide/wider/widest    late / later / latest        large / larger/largest

polite / politely        extreme / extremely        absolute /absolutely

terrible/terribly        probable/probably        reasonable/reasonably

4. Doubling consonants (stop/stopping/stopped, hot/hotter/hottest, etc.)

We double the final consonant (-pp-, -nn- etc.) of these words before -ing, -ed, -er and -est:

stop/stopping/stopped	thin/thinner/thinnest
plan/planning/planned	hot/hotter/hottest

If the word has more than one syllable (prefer, begin, etc.), we double the final consonant only if the final syllable is stressed:

prefer/preferring/preferred  
begin/beginning

Compare:

visit/visiting/visited  
develop/developing/developed

Exception:

travel / travelling/travelled    cancel / cancelling/cancelled

We do *not* double the final consonant if there are two vowel letters before it (-oil, -eed, -ain, etc.):

explain/explaining/explained	quiet/quieter/quietest
cheap/cheaper/cheapest	boil/boiling/boiled

### Keys to the Crosswords

#### *Check Your Progress (1)*

##### *Across*

1. mercury

##### *Down*

2. cement    6. aluminium  
3. rubber    7. hydrogen  
4. iron       8. oxygen  
5. carbon

#### *Unit 7. Section A*

##### *Across*

1. coulomb  
6. pascal

##### *Down*

2. volt            4. ampere  
3. joule          5. watt

#### *Check Your Progress (2)*

##### *Down*

1. essential  
2. quality  
3. fuel  
4. discovery  
5. polymer

6. motion  
7. vehicle  
8. engine  
9. robot

##### *Across*

10. copper  
11. alloy

## CONTENTS

<b>Предисловие</b> .....	3	Lead-in.....	44
Unit One. Engineering.	5	Language Practice .....	45
<i>Section A. An Engineering Student...</i>	5	Reading and Speaking	48
Lead-in.....	5	Activity.....	49
Language practice.....	7	Writing.....	50
Reading and Speaking	11	Unit Four. The Engine .	52
Activity .....	13	<i>Section A. Types of Engines</i>	52
Writing.....	14	Lead-in.....	52
<i>Section B. Some Geometrical</i>		Language Practice .....	53
<i>Figures.....</i>	15	Reading and Speaking	56
Lead-in.....	15	Activity.....	57
Language Practice.....	16	Writing.....	58
Reading and Speaking	18	<i>Section B. Types of Fuel</i>	59
Activity .....	20	Lead-in.....	59
Writing.....	21	Language Practice .....	60
Unit Two. The Basics of Geometry ...	22	Reading and Speaking	63
<i>Section A. Shapes and Forms</i>	22	Activity.....	64
Lead-in.....	22	Writing.....	64
Language Practice.....	23	Unit Five. Instrument Making ....	66
Reading and Speaking	26	<i>Section A. Measuring Instruments .</i>	66
Activity .....	28	Lead-in.....	66
Writing.....	28	Language Practice .....	67
<i>Section B. Measurements</i>	29	Reading and Speaking	70
Lead-in.....	29	Activity.....	71
Language Practice.....	30	Writing.....	71
Reading and Speaking	32	<i>Section B. Devices and Their</i>	
Activity .....	34	<i>Functions.....</i>	72
Writing.....	35	Lead-in.....	72
Unit Three. The Workshop	36	Language Practice .....	73
<i>Section A. Tools and Instruments ...</i>	36	Reading and Speaking	74
Lead-in.....	36	Activity.....	76
Language Practice.....	38	Writing.....	77
Reading and Speaking	42	Unit Six. Engineering Materials. . .	78
Activity.....	43	<i>Section A. Metals and Non-metals . .</i>	78
Writing.....	43	Lead-in.....	78
<i>Section B. Motor Vehicles</i>	44	Language Practice . . .	79
		Reading and Speaking	81
		Activity.....	83
		Writing.....	83

<i>Section B. Properties of Engineering Materials</i>	84
Lead-in.....	84
Language Practice.....	84
Reading and Speaking	87
Activity .....	88
Writing.....	89
Check Your Progress (1)	91
Unit Seven. Experimenting	97

<i>Section A. Experimenting with Car Devices</i> .....	97
Lead-in.....	97
Language Practice .....	98
Reading and Speaking	102
Further Reading .....	103
Activity .....	105
Writing.....	106

<i>Section B. Electrical Devices</i>	107
Lead-in.....	107
Language Practice.....	109
Reading and Speaking	114
Further Reading .....	115
Activity .....	117
Writing.....	118
Unit Eight. Computing.	120

<i>Section A. Computers Today</i>	120
Lead-in.....	120
Language Practice.....	121
Reading and Speaking	125
Further Reading .....	127
Activity .....	129
Writing.....	130

<i>Section B From the History of Computers</i> .....	130
Lead-in.....	130
Language Practice . ...	132
Reading and Speaking	136
Further Reading .....	139
Activity .....	140

Writing.....	141
Unit Nine. Robotics .....	142

<i>Section A. Robots Components</i>	142
Lead-in.....	142
Language Practice .....	143
Reading and Speaking	143
Further Reading .....	149
Activity.....	152
Writing .....	152

<i>Section B. Robots in Operation</i>	154
Lead-in .....	154
Language Practice.....	155
Reading and Speaking	159
Further Reading.....	160
Activity.....	162
Writing .....	163
Unit Ten. Automotive Engineering. .	165

<i>Section A. Some Car Systems</i>	165
Lead-in .....	165
Language Practice .....	166
Reading and Speaking	170
Further Reading.....	172
Activity.....	173
Writing.....	174

<i>Section B. Designing Cars</i>	175
Lead-in .....	175
Language Practice.....	176
Reading and Speaking	180
Further Reading.....	182
Activity.....	183
Writing.....	184

Unit Eleven. Engineering Design...	185
------------------------------------	-----

<i>Section A. Tractor Technology</i>	185
Lead-in .....	185
Language Practice .....	186
Reading and Speaking	190
Further Reading.....	192
Activity.....	193

Writing.....	194
<i>Section B. Machinery Engineering...</i>	195
Lead-in.....	195
Language Practice.....	196
Reading and Speaking	200
Further Reading .....	203
Activity .....	205
Writing.....	206
Unit Twelve. Materials Science . . .	207
<i>Section A. Copper.....</i>	207
Lead-in.....	207
Language Practice.....	208
Reading and Speaking	211
Further Reading .....	213
Activity .....	215
Writing.....	215
<i>Section B. Steel.....</i>	217
Lead-in.....	217
Language Practice.....	218
Reading and Speaking	221
Further Reading .....	223
Activity .....	225
Writing.....	225
<i>Section C. Composite Materials ....</i>	226
Lead-in.....	226
Language Practice.....	228
Reading and Speaking	231
Further Reading .....	234
Activity .....	237
Writing .....	239
Check Your Progress (2)	239
Active Vocabulary.....	246

Unit1 .(246)	Unit 2 (247).
Unit3 (248).	Unit 4 (249).
Unit5 (250).	Unit 6 (250).
Unit 7 (251).	Unit8 (252).
Unit 9 (254).	Unit 10 (255).
Unit 11 (257).	Unit 12 (258).
Grammar .....	262
Unit1 (262). Unit 2 (263). Unit3 (264).	

Unit 4 (265). Unit 5 (266). Unit 6 (266).
Unit 7 (267). Unite (269). Unit 9 (272).
Unit 10 (274). Unit 11 (275). Unit 12
(275). Most Frequently Used
Abbreviations 278
Units of Measurement..279
Conjunctions .....
280
List of Irregular Verbs .281
Spelling .....
283
Keys to the Crosswords284





# BASIC ENGLISH

for Technical Students



ISBN 985-06-0919-2



9 789850 609199

2 BASIC ENGLISH

for Technical Students

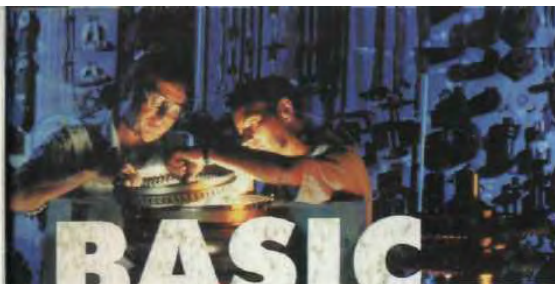

S. A. Khomenko  
V. F. Skalaban  
A. G. Krupenikova  
E. V. Ushakova

# BASIC ENGLISH

for Technical Students



Part 2



# АНГЛИЙСКИЙ ЯЗЫК

ДЛЯ СТУДЕНТОВ  
ТЕХНИЧЕСКИХ ВУЗОВ

## Основной курс

В 2 частях

Часть 2

Под общей редакцией  
кандидата филологических наук доцента С. А. Хоменко  
кандидата педагогических наук доцента В. Ф. Скалабан

*Допущено Министерством образования  
Республики Беларусь  
в качестве учебного пособия для студентов  
технических специальностей учреждений,  
обеспечивающих получение высшего образования*

Минск  
"Вышэйшая школа"  
2004

## ПРЕДИСЛОВИЕ

*Рецензенты:* доцент кафедры методики преподавания иностранных языков "МГЛУ, кандидат педагогических наук *А. П. Пониматко*; доцент, кандидат филологических наук, заведующий кафедрой английского языка естественных факультетов БГУ *Т. Г. Лукаша*

*Все права на данное издание защищены. Воспроизведение всей книги или любой ее части не может быть осуществлено без разрешения издательства.*

Данное пособие является продолжением первой части учебного пособия для студентов технических специальностей вузов (Английский язык для студентов технических вузов: Основной курс. В 2 ч. Мн.: Выш. шк., 2004). Оно включает в себя 6 разделов (Units 13—18), материал для дополнительного чтения и перевода. По аналогии с первой частью в конце пособия имеется раздел "Grammar", словарь активной лексики, ключи к кроссвордам.

Структура второй части пособия однотипна структуре первой части. Текстовый материал пособия заимствован из зарубежных источников, его тематика определена программой подготовки специалистов технического профиля.

*Авторы*

Английский язык для студентов технических вузов:  
А64 Основной курс. В 2 ч. Ч. 2: Учеб. пособие / С. А. Хоменко,  
В. Ф. Скалабан, А. Г. Крупеникова, Е. В. Ушакова;  
Под общ. ред. С. А. Хоменко, В. Ф. Скалабан. - Мн.: Выш.  
шк., 2004. - 207 с.

ISBN 985-06-0919-2.

Представляет собой вторую часть базового учебного пособия для студентов технических вузов. Рассчитано на 70 часов учебного времени. Содержит 6 учебных разделов, раздел для повторения, материал для дополнительного чтения и перевода, грамматический справочник, активный лексический словарь. Каждый раздел включает введение в тему, упражнения для формирования языковых навыков, задания по обучению чтению и говорению, для активизации речи и по обучению письменной речи. Текстовый материал заимствован из зарубежных источников и его тематика определена программой подготовки специалистов технического профиля.

Для студентов технических специальностей вузов.

УДК 811.111 (075.8)  
ББК 81.2 Англ-923

ISBN 985-06-0919-2

© Хоменко С. А., Скалабан В. Ф.,  
Крупеникова А. Г., Ушакова Е. В., 2004  
© Издательство "Вышэйшая школа", 2004

# Unit Thirteen

## MECHANICAL TECHNOLOGY

### Section A. Welding

#### Lead-in

##### I. Discuss the following questions.

- In what branches of engineering is welding used?
- Have you ever seen the process of welding?
- What safety rules should be observed during this process?

##### II. Listen to the students' conversation and learn how to weld workpieces correctly.

*Denis:* Will you tell me how to join these two workpieces, Peter? *Peter:* No problem. It is not very difficult. I think you should use an electric arc to weld the pieces. Are they of the same metal?



*Denis:* Oh, yes. Why do you ask? *Peter:* Well, it is desirable to join the workpieces of the same material, for example, steel to steel, in order to make a very strong joint.

*Denis:* Oh, I see. How do I weld them? *Peter:* Look at these pictures. Everything is shown and explained

here. It is essential to follow all these instructions. *Denis:* OK, I get it. By the way, I hear that electric arc welding is dangerous. Is that right?

*Peter:* Yes. However, if you follow safety rules nothing will happen to you. *Denis:* What safety rules? *Peter:* Don't you know? First of all, it is necessary to put on special

protective clothing, you know, an apron, gloves, rubber boots and a cap. Everything must be dry and clean. Then you should always wear a mask or a helmet to protect your face ...

*Denis:* Fine. Shall we start welding now?

*Peter:* Well, let's try.

##### III. Complete the dialogues.

- Is it easy to...?  
- No, it is rather difficult to do that job. To my mind, you should use an electric arc to ...
- Should the workpieces be made ... metal?  
- Yes, it is desirable to ...
- Electric arc welding is quite dangerous, ...?  
- ..., that is why it is important to ...  
- Will you tell me what they are?  
- Well, it is necessary to ...

##### IV. Match a line in A with a line in B.

- | A   | B  |
|---|--|
| 1. Electric arc welding is widely used in industry. | a) No problem.   |
| 2. Peter, could you help me, please?                | b) Actually, no. Why do you ask?                                 |
| 3. Are the workpieces of the same metal?            | c) An apron, gloves, rubber boots and a cap, a mask or a helmet. |
| 4. I hear that electric arc welding is dangerous.   | d) Well, let's try.  |
| 5. What does special protective clothing include?   | e) Oh, I see.  |
| 6. Shall we start welding now?                      | f) That's true.  |

#### Language Practice

##### Vocabulary

- | A              | B  |
|----------------|--|
| 1. луч         | a) beam    b) bead    c) sunshine    d) laser                |
| 2. сварной шов | a) bead    b) cut    c) weld    d) beam                      |
| 3. свойство    | a) property    b) substance    c) quantity    d) trait       |
| 4. соединение  | a) unit    b) joint    c) particle    d) meeting             |
| 5. трещина     | a) crack    b) cracker    c) canyon    d) web                |
| 6. влиять      | a) to effect    b) to avoid    c) to affect    d) to impress |
| 7. сваривать   | a) to cook    b) to weld    c) to meet    d) to              |

**II. Match the words with the similar meaning.**

niece	anal
must	to make up
the same	workpiece
to hold	essential
flame	similar
to create	to keep
aim	fire
important	should

**III. Divide the words into four columns according to their part of speech.**

workpiece, electric, powerful, transformer, melt, dangerous, continuously, join, safety, quickly, soften, fusion, essential, dry, investment, currently, property, investigate

*Grammar: Infinitive*

**IV. Give advice to your friend how to do things in column A. Choose in column B the right variant.**

EXAMPLE: To mark a hole on the plate you should use a pencil.

B

to drive in the nail	use this new method of welding
to get a strong joint	use these two gases
to cut holes in metal	use a transformer
to create a suitable flame	use a hammer
to provide the necessary electric	use gas welding
current to join two	use an electric drill
steel plates	

**V. Say what device you will use to do the following things.**

EXAMPLE: - *to drill a hole in a plate*

In order to drill a hole I will use a drill.

- If you want:
- to find the necessary information quickly
  - to join two workpieces
  - to assemble cars
  - to cut metals
  - to perform difficult tasks
  - to measure the speed of the car

**VI. Explain why people do the following things. Give as many reasons as you can.**

EXAMPLE: *Why do you use calculators?*

We use calculators in order to count quicker, to avoid mistakes, to save time, etc.

1. Why do people need computers?
2. Why does everybody want a car?
3. Why did you practise in the lab yesterday?
4. Why are we using solar energy nowadays?
5. Why have engineers created robots?
6. Why...?

**Change the structure of the sentences below so as to keep their meaning unchanged.**

EXAMPLE: *It is very important to make a strong joint.*

To make a strong joint is very important.

1. It is impossible to store gas in an open tank.
2. It is quite necessary to make metal electrodes.
3. It is very essential to provide a hot enough flame.
4. It is not difficult to adjust the welding flame.
5. It is unnecessary to mix these substances.
6. It is easy to follow these instructions.

**VIII. How do you find doing these things? Use the adjectives: *important, essential, valuable, easy, difficult, necessary*.**

EXAMPLE: *to put on protective clothing*

It is absolutely necessary to put on protective clothing.

to weld metal joints

to follow the safety rules

to use an electric arc

to join two workpieces of the same material

to provide a powerful electric current

not to use a transformer when welding

**IX. Translate the following pairs of sentences into Russian. Pay attention to the difference between the sentences of each pair.**

1. a) To check the ammeter is necessary.  
b) To check the ammeter it is necessary to connect it to the circuit.

b) To improve the quality of welding we use lasers.  
3. a) To make strong joints you should weld two pieces of the same metal.

b) To make strong joints is essential in automobile industry.

4. a) To follow these instructions is really difficult.

b) To follow these instructions you should read them attentively first.

**X. Restore the original sentences.**

1. is, gas welding, to join, used, steel to steel
2. these metal plates, to join, is, rather, difficult
3. must be supplied, in order to, a current, an arc, create
4. to provide, is, current, at a low voltage, it, necessary
5. to make, a strong joint, to weld, is, the same metal surfaces, it, desirable
6. the operator, protective clothing, himself, should have, to protect

**XI. Correct mistakes.**

1. It is difficult do this job.
2. You should to put on special clothing to protect yourself.
3. You have to wear uniform be safe.
4. The overalls should to be dry and clean.
5. Take workpieces of the same metal in order make a strong joint.
6. It is essential not provide a weak flame.
7. Important not to move the electrode too quickly.
8. To join these plates it is rather difficult.

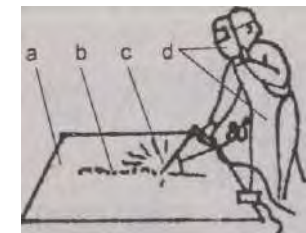

**XII. Translate the sentences into English using your active vocabulary.**

1. Необходимо использовать электрическую сварку, чтобы соединить эти детали.
2. Обычно используют трансформатор, чтобы подать необходимый ток.
3. Сварить эти две металлические пластины совсем нетрудно.
4. Ток должен быть достаточно высоким, чтобы создать необходимую дугу.
5. Чтобы получить прочное соединение, нужно сваривать детали из одинакового материала.
6. Очень важно правильно держать электрод при электрической дуговой сварке.
7. Чтобы получить сварочное пламя, необходимо смешать эти два газа.

2. a) To improve the quality of welding is very important.

8. Лазерная сварка в настоящее время используется для сварки сталей, сплавов и различных материалов, не так ли?

9. Важно упомянуть, что лазерная сварка имеет уникальные преимущества: низкая стоимость, глубокое проникновение и узкий шов, а также скорость и прочность,

10. Чтобы определить свойства лазерных сварных швов, нужно провести много экспериментов.

## Reading and Speaking

I. Look at the pictures and guess what the text is about. Skim the text to see if you were right.

II. How is welding connected to electricity? Find in the text sentences with words of the same root and translate them into Russian.

III. Read the text attentively and find out how to weld plates correctly.

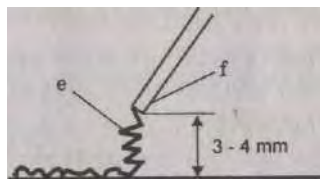

Welding is one of the most important operations that are used in industry. Many parts of machines, automobiles, airplanes, ships, bridges and buildings are welded.

In order to join two metal pieces it is necessary to soften them with heat and then to press, hammer or fuse them together. The most widely used method of welding is electric arc welding where the workpieces are joined by means of electricity at the temperature of about 7,232 °F. **This is the hottest heat that can be obtained for engineering purposes.**

In electric arc welding two workpieces are welded by an electric arc. In order to create the arc a powerful electric current should be provided. The current must be at least 60A and for thicker workpieces it may be 250A or more.

To supply the current it is necessary to use a transformer. The latter must be switched on to strike the arc. To join the workpieces the electrode

holder should contain an electrode rod. When the arc is struck the electrode must brush against the workpiece at 80° to its surface. As the current flows between the electrode and the workpiece the tip of the electrode melts and falls onto the workpiece. Thus a joint is created.

It is essential to hold the electrode approximately 4 mm from the surface of the workpiece. One should not leave the electrode too long in the same position because it will become attached to the workpiece. The electrode must be moved across the joint continuously backwards in a straight line. However, if it is moved too quickly neither the electrode nor the workpiece will melt.

And it is important to remember that to weld plates by an electric arc is quite dangerous. In order to protect yourself you should always follow certain safety rules. For example, it is absolutely necessary to wear overalls with long sleeves, gloves, an apron, a cap, and rubber boots. A mask or helmet is used to protect the face and especially eyes from sparks.

IV. What do letters *a-f* in the pictures refer to?

V. Answer the questions below.

1. What is welding? What processes does it involve?
2. What method of welding is the most widely used today?
3. What device is used to supply the current?
4. How is a joint created?
5. How far should the electrode be held from the workpiece?
6. Why is it dangerous to leave the electrode in the same position?
7. In what way is it necessary to move the electrode across the joint?
8. What safety rules should you follow in the process of welding?

VI. Complete the following sentences with suitable words.

1. ... two workpieces an electric ... is used.
2. It is necessary ... a powerful electric ... for arc welding.
3. ... the workpieces the electrode holder must contain an electrode ....
4. The electrode should be ... some millimeters from the ... of the workpiece.
5. ... a strong joint the workpieces must be of the same ... .
6. The electrode can become ... the workpiece.
7. The electrode must be ... across the ... continuously.

VII. Give a title to the text.

**VIII. Make a dialogue according to the instructions below. Use the words *necessary, useful, essential, etc.* and expressions of request and opinion.**

- Student A.* You have missed your class and you don't know how to weld plates. Prepare your questions and ask your friend for instructions.
- Student B.* Help your friend to understand the welding process. Get ready to answer his questions.

## Further Reading

**I. Modern life is much facilitated by the use of lasers. This equipment has some advantages. Can you name any?**

**II. Laser is an international word today. Skim the text and find all the international words in it.**

**III. Give Russian equivalents to these compound nouns.**

laser beam welding  
high power density welding process  
cost effectiveness

laser welded joints  
joint performance  
conventional weld joint

**IV. Read the text carefully and say what you have learnt about laser welding.**

### Laser Beam Welding

The unique properties of lasers account for their widespread application in manufacturing industry. Laser beam welding is currently used in order to weld steels, aluminum alloys and dissimilar materials. This high power density welding process has unique advantages of cost effectiveness, deep penetration and narrow bead in comparison with conventional welding processes. As the thermal cycles of laser beam welding are generally much faster than those of arc welding it is possible to form a rather small weld zone that exhibits locally high hardness.

However, it is important to point out that the metallurgical and mechanical properties of laser welds and the response of conventional materials to this new process have not been fully established yet. It is currently difficult to determine the tensile properties of the laser welded joint area owing to the small size (-2-3 mm) of the fusion zone. Therefore an experimental investigation of the mechanical properties of laser-welded joints was carried out. To determine the hardness profile of the welded metal three similar joints were

produced by a CO<sub>2</sub> laser and microhardness measurements were conducted at three locations. It is important to mention that the microhardness test results, however, exhibited no significant difference between these three locations for all the welded joints.

The welding process may lead to drastic changes in the microstructure with accompanying effects on the mechanical properties and, hence, on the performance of the joint. Laser welded joints, like all other welded joints, may contain defects in the form of cracks in the narrow weld area. The size and location of such cracks directly affect the joint performance and the lifetime of a structure. Nevertheless, it is essential to remember that laser beam welding has a number of advantages over conventional processes. Despite the high investment cost of laser welding equipment, it is expected that laser beam welding will have a great impact on fabrication and manufacturing industries within the next decade.

**V. Say if the following statements are true or false. Correct the false statements.**

- Laser beam welding is widely used at present.
- Arc welding is less advantageous than laser beam welding.
- Laser beam welding is very hard.
- The research on laser welding has been carried out recently.
- It is currently difficult to establish the properties of the laser welded joint area because the workpiece is very thin.
- Laser beam welding may lead to dramatic changes in the microstructure and the performance of the joint.
- Laser welded joints may contain defects in the form of cracks.
- Laser beam welding is rather expensive, that is why it will not be widely used in industry in the near future.

**VI. Discuss these questions in groups:**

**a) What are the advantages and disadvantages of laser beam welding? Fill in the table.**

<i>Laser Beam Welding</i>	
<i>Advantages</i>	<i>Disadvantages</i>
1. cost effectiveness 2. ... ...	1. unestablished properties 2. ... ...



b) How does laser beam welding differ from arc welding? Compare the two. Use the logical patterns of comparison and contrast.

*comparison:* in comparison with, similarly, in the like fashion, as does X, so does X

*contrast:* in contrast to, on the one hand, on the other hand, however, nevertheless

c) Can you suggest any other ways of welding?

VII. You are an engineer and you want to introduce laser beam welding at the Automobile plant you work at. Persuade the chief engineer that laser beam welding is better than arc welding.

## Activity

I. Ask your friend for his opinion.

EXAMPLE: *(good) to complete this work today / to put it off till tomorrow*  
*A: Which is better: to complete this work today or put it off till tomorrow? B: Well, to my mind, it's better to complete this work today so tomorrow you will be free.*

(easy)	to collect the data / to process it
(useful)	to check welding equipment regularly / to check it occasionally
(difficult)	to follow safety instructions / to neglect them
(valuable)	to invent new things / to improve existing things
(important)	to learn theory / to practise
(good)	to attend classes / to study independently

II. Study these Safety Rules. Discuss with your partner why it is necessary to follow them. Consult the dictionary if necessary.

### **CAUTION**

Welding can be dangerous. Any of these accidents may happen to you:

- you could be blinded by sparks;
- you could get an electric shock;
- your face, body, arms, legs or feet could be burnt;
- there could be a fire in the workshop.

## ***PROTECTIVE CLOTHING***

- A mask or helmet must be worn in electric arc welding. (In gas welding, goggles can be used.)
- Clothes must be kept dry and clean.
- Thick, heavy boots must be worn. These must be made of some insulating material such as rubber.
- Gloves, an apron and a cap must be worn.
- Overalls must have long sleeves and no pockets or cuffs.

## ***WORKSHOP***

- The floor must be made of concrete.
- There must be a metal container on the floor for the sparks.

You can begin as follows:

- Peter, why is it necessary to wear a mask or goggles in electric arc welding?
- Well, it is important to wear a mask and goggles because otherwise you can ....

III. Solve the crossword.

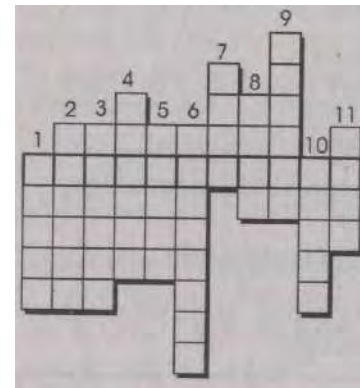

*Down:*

- a flat, thin, usually large piece of something hard
- something imperfect, a fault
- to produce something new
- to change the usual shape of some thing so as to spoil its appearance or usefulness
- a place where things are joined together
- a stated quality, power or effect that belongs naturally to some thing
- a line of light shining out from some bright objects
- laser beam welding produces a very narrow weld ...
- not easily broken, changed or destroyed
- a very thin mark caused by breaking, but not into separate parts

11. to join by pressure or melting together

Across:

1....?

14

## Writing

I. You are a materials engineer and specialize in welding. Recommend your client to introduce LBW in his plant. Point out the advantages of laser beam welding. The linking words and connectors in the box can help you.

first, next, also, besides, furthermore, finally, so, as, because, thus, however, etc.

Complete the memo given below.

### MEMORANDUM

To: Mr. A. Kiselev  
From: Mr {your name}

#### Welding processes

Although this is a preliminary\* report, and further detailed study is necessary, I can safely say that the introduction of laser beam welding is an advantageous alternative to arc welding for a number of reasons.

First of all, it is necessary to ...

Thus I strongly recommend that you immediately consider replacing arc welding by laser beam welding. As a first step I suggest you contact the following companies for advice...

### Предварительный

II. Choose one of the following passages and translate it into Russian. Use the dictionary if necessary.

a) *Oxy-Acetylene welding* relies on the heat of a flame (approximately 3000°C) to melt the material that is welded. Fusion can either be autogenous or with the addition of a filler material. To obtain the high flame temperature that is required for oxy-fuel welding processes it is necessary to combine oxygen with a fuel gas (acetylene or propane). Certain precautions should be taken when you handle these gases. Two techniques are used to weld flat joints: the leftward welding and the rightward welding. The advantages of rightward welding over the leftward technique are higher speed, less *distortion* and more economical use of gas and *filler rod*.

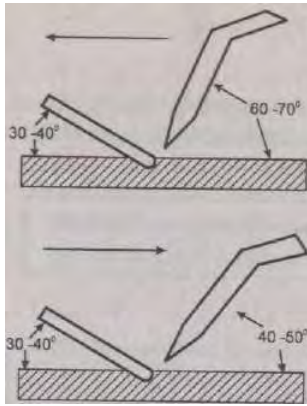

**b) Leftward welding.** To weld low carbon steel and cast iron sheet and plate up to 5 mm in thickness leftward welding is used. As the name implies, the weld is started at the right hand side and progresses towards the left. The filler rod precedes the *blowpipe*<sup>3</sup> and is held at an angle of 30° - 40° to the work surface. The blowpipe is held at an angle of 60° - 70° to the work surface and is given a slight side to side movement to ensure side fusion as the filler rod is fed into the *molten pool*<sup>4</sup>.

**c) Rightward welding.** This method is used on steel plate over 5 mm thick. The weld is started at the left hand side of the joint and progresses towards the right. The blowpipe is held at an angle of 40° - 50° to the work surface and travels in a straight line. The filler rod, which is held at an angle of 30° - 40° to the work surface, follows the blowpipe and is fed into the molten pool with a circular action. A considerable amount of practice is required to perfect this technique.

<sup>1</sup>деформация

<sup>2</sup>присадочный пруток

<sup>3</sup>трубка для подвода сжатого воздуха

<sup>4</sup>сварочная ванна; ванна жидкого металла

## Section B. Mechanisms

### Lead-in

#### I. Discuss the following questions.

- What car mechanisms do you know? Make a list and compare it with that of your partner.
- Can you name the functions of the car mechanisms that you have in your list?

#### II. Listen to the teacher's explanations and learn the functions of the carburettor.

*Pavel:* Could you tell me what a carburettor is? What system does it belong to? *Teacher:* Well, it belongs to the fuel system of the car.

*Pavel:* And what functions does it perform?

*Teacher:* The two functions to be performed by the carburettor are very important. Its first function is to measure exact quantities of the petrol to be mixed with air.

*Pavel:* What is the second function, I wonder?

*Teacher:* Oh, it is to break up petrol into fine particles so that the mixture will burn rapidly, of course.

*Pavel:* And may the carburettor be blocked?

*Teacher:* Certainly, it may happen as petrol contains some dirty particles.

*Pavel:* I see. What is there above the carburettor?

*Teacher:* That's an air filter. Its function is to clean the air to be delivered to the carburettor.

*Pavel:* Does that mean that the carburettor can't be blocked if the filter works well?

*Teacher:* Certainly.

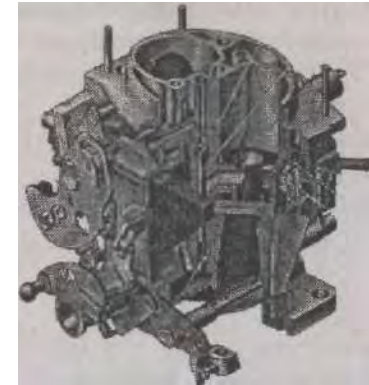

#### III. Complete the dialogues.

- ... does the carburettor perform, I wonder?  
-Well, ...  
-And what is the second ..., I'd like to know? -  
As for ... , it is to ...
- The carburettor is blocked sometimes, ...?  
- Of course, if... . But there is ...
- And what is the function of the filter?  
  
-Oh, I see, ...

#### IV. Match a line in A with a line in B.

- A
- What system does the carburettor belong to?
  - Does the carburettor measure exact quantities of the petrol to be mixed with air?

B

- It is above the carburettor.
- It happens when petrol contains some dirty particles.
- Its function is to clean the petrol to be delivered to the carburettor.

3. What other functions does the carburettor perform?  
 4. When does the carburettor get blocked?  
 5. Where is the air filter situated?  
 6. What is the function of the air filter?
- d) Well, for example, it breaks up petrol into fine particles.  
 e) It belongs to the fuel system of the car.  
 f) Certainly.

## Language Practice

### Vocabulary

I. Find the English equivalents in B to the Russian words in A.

A	B		
1. воск	a) substance	b) mix	c) wax
2. транспортное средство	a) transport	a) means	c) vehicle
3. потребление	a) use	b) need	c) consumption
4. охладитель	a) engine	b) carburettor	c) coolant
5. предотвращать	a) to perform	b) to prevent	c) to avoid
6. клапан	a) piston	b) radiator	c) valve
7. заряжать	a) to charge	b) to discharge	c) to fill
8. количество	a) quality	b) quantity	c) a lot

II. Match the words with the similar meaning.

to consume	to include
to contain	purpose
amount	to purify
to possess	to carry out
to switch on	to turn on
to perform	to use
petrol	gasoline
to clean	quantity
aim	to own

IV. Complete the table with the missing words.

	<i>Verb</i>	<i>Noun</i>
потреблять		
		revolution
	to sense	
		pressure
охлаждать		
	to expand	

### Grammar: Infinitive

IV. Point out the purpose of the objects according to the model.

EXAMPLE: A: *This paper describes important properties of new engineering materials.*

B: The purpose (aim, goal, object) of this paper is to describe properties of new materials.

- This experiment establishes the relations between these two quantities.
- The article deals with the prospects for electric road cars.
- This book gives the description of the electrical instruments in the car.
- His report presents some information on the new fuel system.
- The speedometer is used to indicate the speed of a car.
- The filter is used to clean petrol.

V. Define the functions of these objects: *a petrol tank, a robot, the Internet, a carburettor, a battery, a vehicle, a laser, a ruler, a tachometer.*

EXAMPLE: The function (purpose) of a speedometer is to indicate the speed of a car.

VI. The two sentences on p. 20 have a different structure but the same meaning. Change the structure of the sentences so as to keep their meanings unchanged.

EXAMPLE: A: *The substance that should be analysed is of great value.* B: The substance to be analysed is of great value.

1. The equipment that should be installed in the workshop has specific use.
2. The petrol that should be delivered from the petrol tank should be clean.
3. The new battery that should be used in the car is very effective.
4. The new car devices that should be developed have several advantages.
5. The car emissions that should be controlled are very harmful to the environment.
6. The automobile that should be developed will run on hydrogen.

#### VII. Restore the original sentences.

1. the carburettor, the function of, petrol, is, to break up, fine particles, into
2. the instruments, to be located, with important information, the instrument panel, provide, the driver, on
3. the petrol, should be, clean, to be delivered, to the carburettor
4. the hydrometer, is, the condition of the battery, the function of, to check
5. to be performed, very important, the functions, are, by this device
6. is, the new fuel system, in this car, completely, of a new design, to be employed

#### VIII. Correct mistakes.

1. The aim of an instrument panel is provide the driver with certain information.
2. When the driver notices some fault it essential to repair it at once.
3. The function of the tachometer to indicate the engine speed in revolutions per minute.
4. The speed limit to was adopted in populated areas is 30 mph.
5. I have a battery to recharging.
6. Drivers must don't speed, especially when they see speed limit signs.
7. The properties to studied may be of great value.
8. You must go to the service station in order repair the brakes.

#### IX. Translate the sentences into English using your active vocabulary.

2. Моя задача заключается в том, чтобы найти неисправность в этом приборе.
2. Функция этого прибора - измерять давление в системе.

3. Статья дает следующую информацию: назначение карбюратора - дозировать количество бензина, который должен смешиваться с воздухом.
4. Новая топливная система, которую нам нужно разработать, будет иметь ряд преимуществ.
5. Важно помнить, что карбюратор может быстро засориться, если в бензине есть частицы мусора.
6. Известно, что функция фильтра - очищать бензин от сора и пыли.
7. Если в бензобаке мало топлива, на панели загорится предупредительная лампочка.
8. Вот термостат, который нужно заменить.
9. Функциями термостата являются обеспечение быстрого нагрева двигателя и предотвращение его остывания в рабочем режиме.

---

## Reading and Speaking

---

I. Modern cars have a complex instrument panel. Why is it a necessary component of any car? What instruments does it include? What are their functions? Scan the text to get the answers to the questions.

II. Look through the text and find the derivatives from the following verbs: *to alternate, to revolve, to drive, to supervise, to sense.*

III. Read the text for more information about the instrument panel of the car.

### The Instrument Panel of a Car

A modern car is a complex means of transport. However, it is relatively easy to operate as a number of devices help you to keep control. An instrument panel in a modern car, for example, provides the driver with valuable information. It includes such instruments as a speedometer, a fuel gauge, a tachometer and an ammeter.

The function of the speedometer is to indicate the speed of the car. A speed limit to be adopted for towns and built-up areas is 30 miles per hour or 60 km per hour.

The purpose of the fuel gauge is to indicate the amount of fuel to be contained in the petrol tank. If its level in the tank is very low, the warning light switches on in the car. When this happens it is necessary to put some more petrol into the tank.

The tachometer is necessary to indicate the engine speed in revolutions per minute. When the engine turns slowly at the minimum speed the alternator also turns slowly. It doesn't produce enough current for the engine. Therefore, the battery must supply the necessary current.

A car battery can easily become discharged in quite a short time. The function of the ammeter is to indicate whether the battery is charging or discharging.

Instrument panels in the cars in the near future will become much more complicated. The common devices will soon be replaced by onboard computer systems, as intelligent vehicles are the field to be researched nowadays. The idea is to create automatic cars on automatic highways. The vehicles to be introduced will move with the minimum supervision on the part of man since they will communicate with one another and with the road sensors on the way. This is necessary in order to reduce the load on drivers and to ease the stress on the road network. The leading engineering companies are using advanced mechatronics to achieve this goal.

**IV. Fill in the table with the data from the text.**

<i>The Instrument Panel</i>	
<i>Instruments</i>	<i>Functions</i>
1. ...	to indicate the speed of a car
2. a fuel gauge	...
3....	to indicate the engine speed in revolutions
4. an ammeter	...
5. onboard computers	...

**V. Answer the questions.**

1. The aim of the instrument panel is to provide the driver with information, isn't it?
2. Does the instrument panel include such instruments as a multi meter and a fuel gauge?
3. Is the speed limit for towns and built-up areas 30 mph or more?
4. What is the function of the fuel gauge?
5. Why does the warning light switch on?
6. What instrument indicates if the battery is charging or discharging?
7. How will the instrument panel change in future? What will cause the changes?

**VI. Complete the following sentences.**

1. An ... panel provides the ... with valuable information.
2. The ... of the ... is to indicate the amount of the petrol to ... in the petrol tank.

3. An instrument panel in the car ... a speedometer, ..., a fuel gauge and ....
4. The tachometer indicates the ... of the engine in ... per minute.
5. The battery must ... the necessary.....
6. A car ... can easily ... discharged.
7. The function of .the ... is to indicate whether the ... is ... or discharging.
8. The idea is ... intelligent ... that will ... the load on drivers and ... the stress on the ....

**VII. Give the gist of the text. Start with the words given below.**

1. In this text we look at...
2. The text deals with ...
3. The text gives information on ...
4. The text is about ...

**VIII. Discussion.** Some of the city authorities want to introduce the automatic car system on the road in Minsk but some of them have doubts. Make two teams ('for' and 'against') and discuss the following question: *Are automatic cars worth introducing?* Try to come to an agreement.

---

## Further Reading

**I. What do you know about thermostats? Where are they used? What are their functions? What are the types of thermostats? Scan the text to find the answers.**

**II. Find in the text international words and translate them into Russian.**

**III. Translate the following compound nouns into Russian:**

- |                               |                         |
|-------------------------------|-------------------------|
| a heat sensor                 | a top hose              |
| liquid pressure               | the coolant temperature |
| hot water flow                | a coil spring           |
| a wax type thermostat         | engine wear             |
| a temperature-sensitive valve | fuel consumption        |

**IV. Read the text and say what you have learnt about thermostats.**

As the dictionary says, the thermostat is an apparatus that can be set to keep a room, machine, etc., at an even temperature as it connects and disconnects the supply of heat when necessary. In short, the thermostat is used to control the temperature. How does it work?

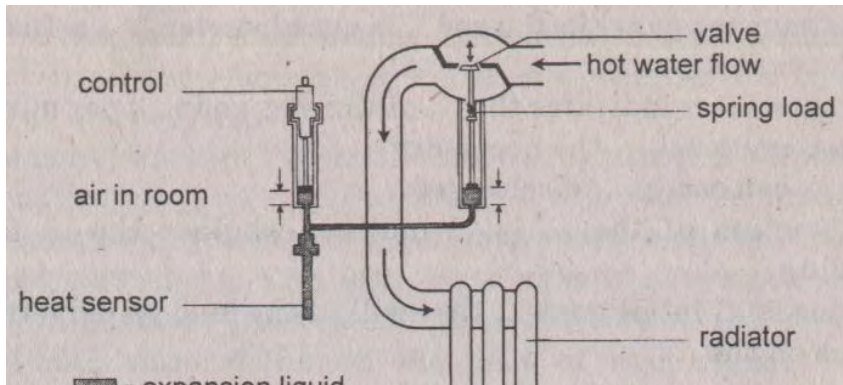

As it is known liquids expand when they are heated. This effect is used in the thermostat in the picture. With an increase in the air temperature the liquid expands in the heat sensor. This expansion causes the valve to close in order to reduce the flow of hot water. After a short time, the temperature goes down and consequently the liquid cools and contracts. The spring load is now greater than the liquid pressure, so the valve will open. Once again, the hot water flow is increased. This type of the thermostat is widely spread in various heating systems.

The same principle is used in the wax type thermostat, which is almost universal in modern vehicles. This thermostat is a temperature-sensitive valve that is situated just below the top hose. As the coolant temperature rises, the valve is opened by the expansion of the wax inside it. When the temperature falls, the valve is automatically returned to the closed position by a coil spring. When thermostats of this type fail, it is very important to replace them immediately. It is normally more convenient to fit a new one than to overhaul the old one.

The thermostat is used to prevent the flow of water to the radiator when **the coolant temperature is less than about 80°C. Its functions** are as follows:

- to allow the engine to become warm quickly. Both engine wear and fuel consumption are increased if the engine is operating at a low temperature;
- to prevent the engine from remaining cool under running conditions.

**V. Say if the following statements are true or false. Correct the false statements.**

1. The thermostat is a device to control the supply of heat.
2. Liquids expand when they are cooled.
3. Wax does not expand when the temperature rises.

4. The valve is opened by the expansion of the wax outside it.
5. When the wax type thermostat fails you should replace it at once.
6. The thermostat prevents the flow of water to the battery when the **coolant temperature is below 80°C.**
7. The higher the temperature of engine operation, the more fuel is consumed.

**VI. Read these gists of the text and find the one which corresponds to the contents best. Explain your choice.**

1. In this text we consider universal devices in modern vehicles.
2. This text deals with the wax type thermostat, its operation and functions.
3. This text provides information on the principles of the thermostat operation.
4. The text informs us of thermostats, their functions and principles of operation.

**VII. Make a short report on thermostats, their functions and principles of operation.**

## Activity

**I. Name the objects in the picture according to the following description and say what functions they perform. Work with your partner.**

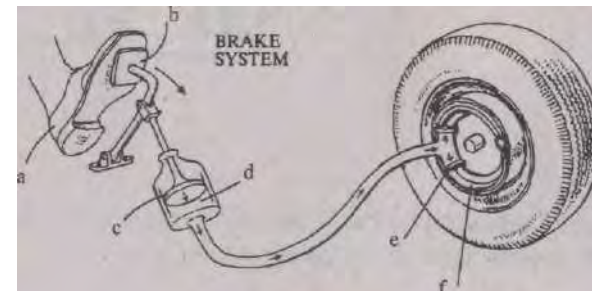

1. The foot presses the pedal.
2. The pedal pushes the first piston down.
3. The piston squeezes the oil.
4. The oil pushes the second piston outwards.
5. The second piston pushes the brake shoe against the wheel.
6. The wheel stops.

- EXAMPLE: - What is *e* called, I wonder?  
 - It is called a piston, of course.  
 - And what is its function?  
 - Its function is to push the brake shoe against the wheel.

II. Ask you friend to explain to you the purpose of various devices in the car. Use the dictionary if necessary.

You can start like this:

- Denis, what is the function of the ...?
- Well, its function is to ...

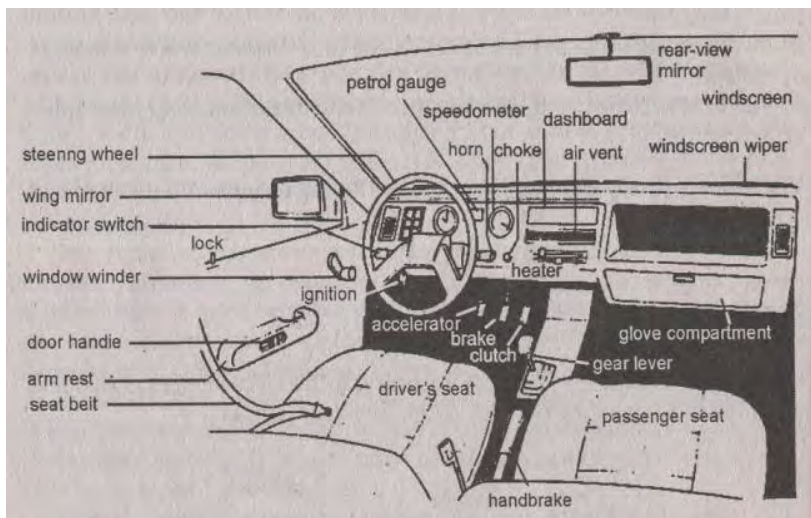

## Writing

I. Write a short paragraph that contains a description of the most important car mechanisms and their functions.

II. Translate the text into Russian. Use the dictionary if necessary.

### Automated Highway Systems: Principles of Operation

1. *Vehicle system checkpoint*: Every vehicle is equipped with a *transponder*<sup>1</sup>. Its function is to send out a signal to road sensors to be located in the *validation lane*<sup>2</sup> in order to provide them with the

status of all onboard computer systems. If all systems are functioning correctly, control of the vehicle is assumed by the system.

2. *In-vehicle navigation system*: Its function is to note the driver's destination point.

3. *Automated highway system*: It moves the vehicle into a protected lane. Its task is to maintain safe control of the vehicle speed and steering. To achieve this result, adaptive cruise control<sup>3</sup> systems, automatic braking systems and *collision avoidance*<sup>3</sup> systems are introduced. When the driver's destination is reached control is returned to the driver.

4. *At destination*: When the car is approaching the destination, a signal is emitted that advises the driver to resume manual control. The function of the transponder now is to send signals to other cars, which create a space so that the given car can exit.

- <sup>1</sup> ретранслятор
- <sup>2</sup> проверочная полоса
- <sup>3</sup> избегание столкновений



# Unit Fourteen

## ELECTRICITY

### Section A. Electricity Basics

#### Lead-in

I. Discuss the following questions.

- Can you imagine our life without electricity?
- What benefits can we get from electricity?

II. Some students are writing their coursework now. Suddenly the light went off. Listen to their conversation to see how they will solve this problem.

*Olga:* Alex, I need your help badly. I'd like you to have a look at my table lamp.

*Alex:* What is wrong with it?

*:* I have no idea. I was writing my coursework when suddenly

*Olga:* the light went off. Can you repair it?

I'll try. Give me the lamp.

*Alex:* Well?

*Olga:* No wonder the light doesn't work. The bulb has a broken filament.

*Alex:* What do you mean?

*Olga:* The bulb has simply burnt out. All we have to do is to turn the burnt bulb out of the socket and replace it with a new bulb. Do you have one?

*Olga:* Unfortunately not. And my roommates are all asleep - I can't ask them. You can't lend me your own lamp, can you?

*Alex:* Well, yes. But it is time to sleep already. Why don't you finish the coursework in the morning?

*Olga:* You see, my supervisor asked me to bring it to the consultation tomorrow. He expects me to finish it.

*Alex:* OK. Don't sit up too late anyway. I'll ask Irene to bring you a new bulb. Don't switch on the power till you have turned it into the socket.

*Olga:* I won't. Thanks a lot.

III. Complete the dialogues.

- Nick, I need you to ...  
-...? It was all right five minutes ago.
- I'm afraid ...  
- Don't worry. We'll ask somebody to ...
- Let's ...  
- Well?  
- You see, ...  
- What shall we do?  
- ... . But I'd like you to ... the power first.  
- ...  
- I'm sure you won't forget to turn on the ... again. The light will let ... your report.

IV. Match a line in A with a line in B.

A

A

B

- |  |   |
|--|---|
| 3. have a look.  |   |
| 4. What is wrong with it?                                  |   |
| 5. Yes, the teacher made him rewrite his lab report.       |   |
| a) Is Michal busy now?                                     | 6. He warned me not to switch on the power till he asks.                    |
| b) Did you ask me to come?                                 | 7. Yes, we'd like you to change the burnt bulb.                             |
| c) What did the engineer tell you?                         | 8. Well, my supervisor expects me to bring it to the consultation tomorrow. |
| d) Why are you in such a hurry to complete the coursework? |   |
| 1. The lamp is out of order.                               |   |
| 2. Could you help me repair the circuit?                   |   |

Language Practice

#### Vocabulary

I. Find the English equivalents in B to the Russian words in A.

A

B

- |                        |               |              |              |
|------------------------|---------------|--------------|--------------|
| 9. <b>непроводник</b>  | a) dielectric | b) discharge | c) domestic  |
| 10. <b>выпрямитель</b> | a) condenser  | b) rectifier | c) capacitor |
| 11. <b>обмотка</b>     | a) voltage a) | b) winding   | c) insulator |
| 12. <b>первичный</b>   | primary       | b) secondary | c) early     |

- |                             |               |              |                |
|-----------------------------|---------------|--------------|----------------|
| 5. передавать               | a) to keep    | b) to store  | c) to transmit |
| 6. нить накала              | a) filament   | b) gap       | c) coil        |
| 7. частота                  | a) resistance | b) frequency | c) alteration  |
| 8. светиться.<br>накаляться | a) to reverse | b) to rotate | c) to glow     |

II. Match the words with the opposite meaning.

- |              |                  |
|--------------|------------------|
| to turn into | to increase      |
| insulator    | to turn out (of) |
| to decrease  | closed           |
| direct       | step-down        |
| initial      | alternating      |
| to open      | final            |
| step-up      | conductor        |

III. Cross out the odd word. All the words in the line should belong to one part of speech.

- complete, carry out, measurement, perform
- wire, bulb, socket, switch off
- winding, capacitor, frame, rectify
- current, power, electrical, flow
- into, out of, from, careful
- transformer, alternate, rectifier, generator
- voltage, insulate, frequency, resistance

### Grammar: Complex Object

IV. Report what these people said.

EXAMPLE 1: *The instructor said to the students, "Switch off the power immediately".*

The instructor told the students to switch off the power immediately.

- Sasha said to Sergey, "Connect the ammeter to the circuit".
- Alice asked Oleg, "Control the electrical pressure in the circuit".
- Denis warned Natasha, "Take the bulb out of the socket first".
- Kate reminded Oleg, "Measure the potential difference across two points in a circuit".

EXAMPLE 2: *Mr. Pavlov said to the students, "Don't increase the pressure in the system".*

Mr. Pavlov told the students not to increase the pressure in the system.

- Alice said to Paul, "Don't switch on the power".
- Natasha warned Oleg, "Don't connect the contacts of the circuit".
- Alice asked Susan, "Don't use faulty electrical devices in your work".
- Nick ordered Ann, "Don't touch the socket".

V. Explain why these things happen.

EXAMPLE: *water / to flow down - wheel / to turn*

The water flows down. - This makes (lets) the wheel turn.

- temperature / to increase - liquid / to expand  
 valve / to be open - water / to flow in the system  
 bulb / to burn out - you / to change it  
 contact / to be closed - current / to flow in the circuit  
 leads / to be connected - current / to pass through the conductor  
 batteries / to discharge - electric car / to stop

VI. a) What do these people want others to do for them? Fill in the table.

EXAMPLE: *Oleg: - Students, switch on the power, please.*

Oleg	would like	them	to switch on
Alice	want(s)	(the students)	the power.
Helen	wish(es)	...	...
Roman	desire(s)	...	...
Teacher	need(s)	...	...
Natasha and Rita	expect(s)	...	...
We	...	...	...

- Alice: - Nick, test the bulb.
- Helen: - Oleg, carry out all the necessary calculations.
- Roman: - Olga, describe the work of a transformer.
- Teacher: - Helen, draw a simple circuit, please.
- We: - Alex, complete the measurements.
- Natasha and Rita: - Please, turn off the power.

b) What would you like your friends to do for you? Give as many versions as you can.

VII. a) Say what things these people don't want others to do.

EXAMPLE: *Students: - Pavel, don't switch off the lights, please.*

Students I Nina and Alice	<u>don't</u>	<u>want</u> wish desire need expect	<u>him (Pavel) to switch off</u> the lights.
Olga Nick	doesn't		
Denis Sasha	wouldn't	like	

- I: - Students, don't touch the wiring.
- Nina and Alice: - Peter, don't connect the voltmeter to the circuit.
- Olga: - Marina, don't turn off the whole current.
- Nick: - Freshmen, don't apply the old method of calculations.
- Denis: - Professor, don't switch off the ceiling lights, please.
- Sasha: - Don't turn the bulb out of the socket.

b) Name 5 things that you wouldn't like your friends to do.

VIII. These two sentences have a different structure but the same meaning. Change the structure of the sentences below so as to keep their meanings unchanged.

EXAMPLE: *This allowed him to follow the rules. This allowed the rules to be followed.*

- This device enables the students to measure the current in the circuit.
- This analysis permitted them to obtain new data.
- The information enables us to predict the properties of the new substance.
- This result forced them to check the circuit again.
- Modern equipment caused us to introduce new methods.
- The tutor would like us to complete the coursework on time.

IX. Restore the original sentences.

- this device, an electrical charge, enables, to be built up and stored 2.1, you, out of the socket, told, to remove, the bulb
- this, the current, makes, flow, through the circuit
- she, him, the contacts, wanted, of the circuit, to connect
- the transformer, to be increased or decreased, the voltage, allows
- one, the current, can assume, in one direction, to flow, only

X. Correct mistakes.

- Nick asked Boris turn the bulb clockwise.
- New data let us to carry out another experiment.
- Mr. Pavlov told the students to not use a broken voltmeter.
- The flow of water makes the wheel to turn.
- His discovery allowed an invention be made.
- Roman was asked test the bulb.
- Alice expected Paul connect the contacts of the circuit.
- This fact didn't let Andrew to break the rules.
- The assistant warned them not create a magnetic field.

XI. Translate the sentences into English using your active vocabulary.

- Лампочка перегорела, и я хочу, чтобы ты ввинтил в патрон новую.
- Мне нужно, чтобы он сейчас отключил электричество.
- Вы хотели бы, чтобы я объяснил вам основы электричества?
- Выпрямитель позволяет электрическому току протекать только в одном направлении.
- Этот прибор позволяет нам измерить напряжение в цепи.
- Если контакт открыт, ток не проходит по цепи.
- Преподаватель попросил начертить схему электрического прибора.
- Магнит заставляет ток менять направление.

## Reading and Speaking

I. Are you good at electricity? Match the objects with their symbols. cell, 6V battery, wire, bulb, switch, ammeter, voltmeter, ohmmeter

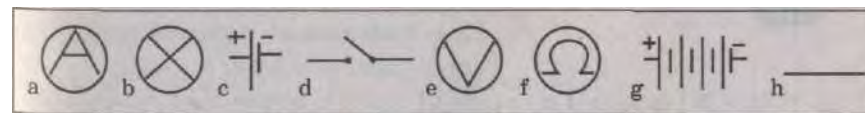

II. Practise reading these words.

filament ['filemant] insulator  
['insuleite] kinetic [kai'netik]  
alternating [,alte'neitin]  
frequency ['fri:kwansi]

III. Look at the title and the picture and say what information the text gives. Read the text attentively for the details.

## Electricity Basics

Electricity is something we do not notice until we do not have it. However, few people understand what it is and still fewer can explain it. Let us try it anyway.

So, what is electricity? Electricity is simply a movement of charged particles through a closed circuit. The electrons, which flow through this wire, carry a negative charge. A lightning discharge is the same idea, just without the wire.

Electricity is made by converting some form of energy into flowing electrons at the power plant. The type of power plant depends on the source of energy used: thermal power (coal, oil, gas, nuclear, underground steam), solar power (photovoltaic), kinetic power (water, wind) and chemical power (fuel cell).

After it is made, electricity is sent into a system of cables and wires called a transmission grid. This system enables power plants and end users to be connected together.

The basic notions in electricity include the following.

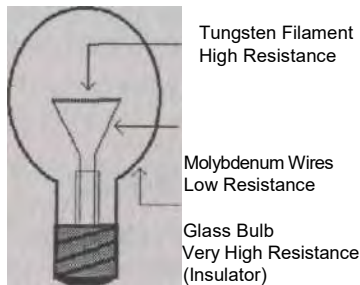

An Amp (A) is a unit measure of the amount of current in a circuit. An ammeter permits the current to be measured.

The pressure that forces the current to flow is measured in Volts (V). A transformer is used to change the voltage of electricity. This allows electricity to be transmitted over long distances at high voltages, but safely used at a lower voltage.

A Watt (W) is a unit measure of electric power that depends on amps and volts. The more watts the bulb uses the more light is produced.  $Watts = Volts \times Amps$ .

An Ohm ( $\Omega$ ) is a unit measure of materials resistance to a flowing current. The filament in this light bulb glows because its high resistance makes it hot. Low resistance of the support wires does not let them glow. The glass has a resistance so high that it does not allow the current to move through it - this property makes glass a good insulator.

IV. Provide answers to the questions below.

1. What is electricity and an electron?
2. How is electricity produced?
3. What types of power plants do you know?
4. What is the function of the transformer?
5. How does the light bulb work?
6. Glass is a poor insulator, isn't it?

V. Complete the table with the data from the text.

Symbol	Unit	Electrical Notion	Measuring Device
1.			ammeter
2.	Volt		
3.		resistance	
4. W			

VI. You are taking your exam in Physics. Your examination card says: Electricity, its definition and basic notions. Your partner is your examiner. Answer his questions and try to get a good mark.

- Well, what is electricity?
- Oh, electricity is ...

VII. What new information have you learnt about electricity from the text? What things have you already known?

## Further Reading

I. Practise reading these words.

rectifier ['rektifaie] wind wound [waund]  
[waind] primary ['praimeri]

II. Do you know what DC and AC mean? How are they produced? What are their functions? What do you know about the transformer?

III. Skim the text to find out the functions of these things:

- a) power station,
- b) transformer,
- c) rectifier,
- d) overhead conductor wires,
- e) magnetic field,
- f) capacitor,

IV. Read the text carefully for more information on electricity.

## Electricity Basics (continued)

There are two different kinds of electrical current. One is called direct current because electrons are made to move in one direction only. It is usually abbreviated to DC. This kind of electricity is produced by a battery.

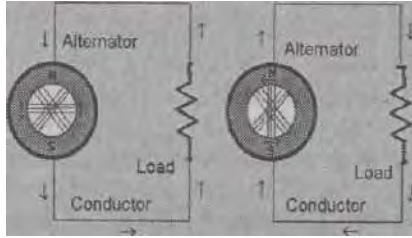

AC stands for alternating current, which is generated by power stations for domestic and industrial use. The wires in the centre of the generator rotate past the North and South poles of the (red) magnet. This movement forces the electrons in the circuit to reverse the direction of their flow. The number of these alterations (or cycles) per second is

known as frequency.

As domestic supply requires alternating current it is therefore necessary to change it to direct current inside most electrical appliances. A rectifier allows AC to be converted into DC.

Power stations are designed to provide electrical energy to large housing developments. This causes the necessity to transmit power from its source, the generating station, to wherever it is required for use, which may be far away, with minimal energy losses. It is cheaper and easier to carry a very high voltage but low current, over long distances. It can be done with the help of thinner overhead conductor wires, with an air gap between them to act as an insulator,

A transformer is used to increase or decrease the voltage of an electric power supply. This is a static machine since it has no moving parts. It consists of two coils of wire that are wound around a soft iron core. The coils are called windings, one is the primary, or input winding, and the other is the secondary, or output winding.

When current passes through the primary winding, a magnetic field is created around the iron core, which induces a voltage in the secondary winding. If the number of turns in the secondary winding is greater than that in the primary winding it is a step-up transformer and the output

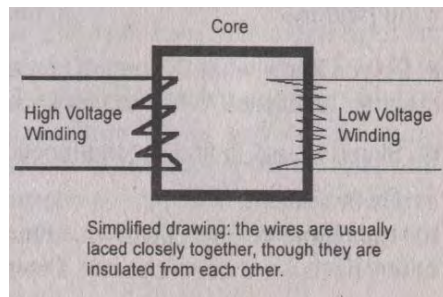

voltage is greater than the input voltage. And vice versa, a step-down transformer enables the input voltage to be reduced.

A device, which allows an electrical charge to be built up and stored for some time is known as a capacitor (or a condenser). A simple capacitor is made from two metal plates (electrodes), which are separated by an insulator such as air, paper or mica (the dielectric).

V. Say if the following statements are true or false. Correct the false statements.

1. There are two different kinds of electricity: AD and **BC**.
2. Direct current is received from a battery.
3. AC is used for domestic and industrial purposes.
4. The frequency is the number of cycles per second.
5. Conversion is brought about by means of an insulator.
6. Air is a rather good insulator.
7. High voltage is supplied by a transformer.
8. To decrease voltage a step-down transformer should be used.
9. The function of a capacitor is to transmit electricity to electrical appliances.

VI. Explain why...

- a) two kinds of current exist.
- b) electrons change the direction of the flow in AC.
- c) a rectifier is necessary.
- d) energy is lost on the way from the power plant to the end user.
- e) a high voltage and low current are transmitted through the wires.
- f) a transformer is used.
- g) a transformer is known as a static machine.
- h) a step-up transformer permits the input voltage to be increased.
- i) a condenser is necessary in domestic appliances.

VII. Give another title to the text. Can you render its contents in 6 simple sentences?

## Activity

- I. Create a questionnaire on the topic 'Basic Electricity' and test your classmates' knowledge.
- II. Describe a step-down transformer, its structure, operation and function. Use the description of a step-up transformer as a model.

### III. Solve the crossword.

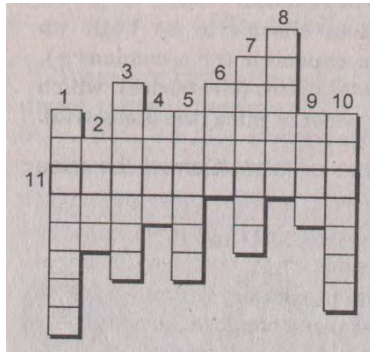

#### Down:

1. to pass power from its source to the end-user
2. power, current, ...
3. to change alternating current into direct current
4. up-down, closed - ...
5. current that flows in one direction
6. their number in the winding influences voltage
7. the input winding is also called ... winding

8. it alters the direction of charges
9. support wires in the bulb don't do it because they have low resistance
10. the complete circular path of an electric current

#### Across:

11.?

## Writing

- I. Study the picture and describe in writing how electricity is produced and then transmitted to our houses.

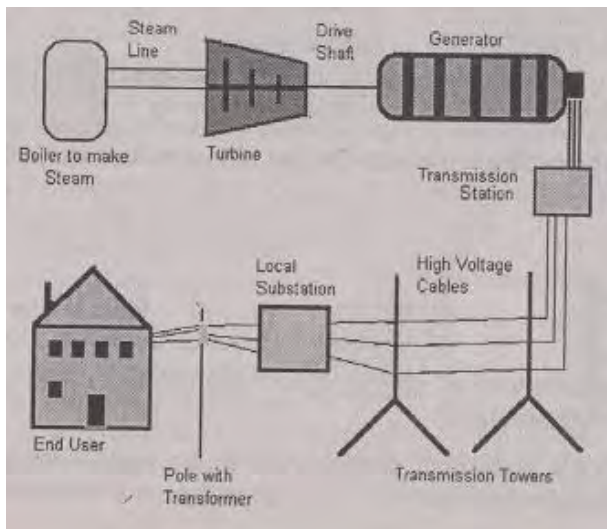

### II. Translation Check. Use your dictionary if necessary.

## Lightning

To strike the ground lightning must pass two stages. First, a stream of negative electrical charge comes down from the storm cloud in steps. It travels about 160 feet at about fifty-millionths of a second and stops; then moves on another 150 feet and stops - and so on towards the ground. Its function is to create an electrical connection between cloud and ground. The bright flash we know as lightning is the 'return' stroke. It is seen when positive electrical charge travels up from ground to cloud at about a million miles an hour along the path of the least resistance that had already been established.

Plenty about lightning is still unknown. Cloud and ground are like terminals of a ten-million-volt battery. What charges the battery in the first place? Even the latest scientific achievements do not permit this and other questions to be answered as yet. Electrification of storm clouds remains one of the unsolved mysteries of the weather.

## Section B. Solar Energy

### Lead-in

#### I. Discuss the following questions.

- a) What role does the Sun play in our life?
- b) Some pocket calculators are powered by solar cells, but many use batteries. What are the advantages of using solar cells? Are there any disadvantages?

#### II. Listen to the students' conversation and name the advantages and disadvantages of solar-powered cars.

*Sveta:* Alex, just look at this car. It seems to be quite modern.

*Alex:* Well, it is the latest model of a pollution-free car. *Sveta:* How interesting! What fuel does it run on?

*Alex:* It is a solar-powered car - it runs on solar energy. *Sveta:* Are these cars fast moving?

*Alex:* Well, they are reported to take part in races and even win them.

*Sveta:* Oh, really? Do these cars have any disadvantages? As far as I understand, they are sure to stop in cloudy weather and at night when there is little or no sunlight.

*Alex:* You have a reason here. However, for such cases these cars are provided with solar batteries that accumulate excess energy when there is lots of sunlight and power the car when there is no sunlight.

*Sveta:* That appears to be a solution to the problem.

*Alex:* Yes, but these solar batteries are numerous and quite heavy. This makes solar-powered cars rather inefficient at present. There are other questions to tackle.

*Sveta:* Why do engineers develop these cars if they cause so many problems?

*Alex:* As the pressure on fossil fuels is likely to increase we have to search for other sources of energy and the solar power is one of them. This energy source is considered to be inexhaustible.

*Sveta:* I see.

### III. Complete the following dialogue.

- This car seems quite modern, doesn't it?
- ...
- What source of energy does it use?
- ...
- ...! Does this car develop high speed?
- Well, ...
- I'm afraid such cars are sure to ...
- No need to worry. They are supplied with ...
- Do they make solar-powered cars efficient?
- Not quite, ...
- What is the major advantage ...?

### IV. Match a line in A with a line in B.

- |  |  |
|--|--|
| 1. What is so special about these cars?  | a. They are believed to reduce water-heating costs by about 50%. |
| 2. Are solar-powered cars fast?          | b. They appear to be very expensive.                             |
| 3. What are the drawbacks of these cars? | c. Well, they are considered to be pollution free.               |

- |   |   |
|---|---|
| 4. Why are solar-powered cars created?          | d. It seems so.   |
| 5. There are still numerous problems to tackle. | e. Yes, they are reported to win races.                                       |
| 6. Are solar heating systems cost-efficient?    | f. We are likely to run out of fossil fuels soon and there will be no petrol. |

## Language Practice

### Vocabulary

#### I. Match the words with the similar meaning.

to convert	to tackle
to solve to	large
absorb to	to turn into
seem to	to provide
supply	to consider
usually	to appear
huge to	to capture
think	normally

#### II. Make up all possible word combinations.

solar	array
huge	amount
electrical	energy
inexhaustible	resource
to power	cars
metal	surface
to supply	heat

#### III. Find in B the derivatives from the words in A.

A	B
1. to pollute	- power, pollution, production, pressure
2. to charge	- change, research, discharge, consumer
3. to power	- solar-powered, overcharge, operation, piping
4. to exhaust	- explanation, expensive, efficiently, inexhaustible
5. to vary	- vice versa, variation, weekly, invention
6. new	- well-known, consequently, renewable, efficiency
7. complete	- competition, completely, tremendous, economical

## Grammar: Complex Subject

### IV. Match the beginnings of the sentences with their ends. Pay attention to the verbs used with Complex Subject.

- |  |   |
|--|---|
| 1. Second-year students are expected to...             | a) generate 100 kilowatts of electricity. |
| 2. The kilowatt-hour is known to ...                   | b) know the basics of electricity.        |
| 3. Alternative sources of energy are considered to ... | c) be the unit measure of electricity.    |
| 4. The solar village was reported to ...               | d) be inexhaustible.                      |
| 5. The resources of fossil fuels seem to...            | e) produce no pollution.                  |
| 6. Solar-powered cars turned out to ...                | f) be connected.                          |
| 7. A small windmill is likely to ...                   | g) come to an end.                        |
| 8. Electricity and magnetism are sure to...            | h) be built in Australia.                 |

### V. Open the brackets and use the verbs in the correct form.

- Some materials (to prove) to produce electricity when they are exposed to light.
- The battery (to be likely) to be recharged.
- Mr. Frolov (to say) to be a good engineer.
- The collector (to suppose) to be black.
- That energy source (to seem) to be inexhaustible.
- A specialist (to expect) to tackle all the technical problems.
- The solar thermal heating systems (to assume) to be very efficient.

### VI. These two sentences have a different structure but the same meaning. Change the structure of the sentences below so as to keep their meaning unchanged.

EXAMPLE 1: *It is found that the battery is dead.* The battery is found to be dead.

- It is believed that a single PV cell produces approximately 0.5 V.
- It is likely that the energy crisis will soon begin.
- It seems that the results of the solar project are very important.
- It is unlikely that engineers will find a solution to the problem quickly.

EXAMPLE 2: *We expect this method to offer some advantages.*

This method is expected to offer some advantages. 1. They consider this housing development to be unique.

The car mechanic believes the solar-powered car to have many advantages.

- We assume the solar power to be tremendous.
- He supposes the Sun to run water turbines.

### VII. Express the same idea:

#### a) less categorically.

EXAMPLE: *This method gives good results.*

This method seems (appears, is likely, is said) to give good results.

- This new substance has valuable properties.
- Solar collectors are very efficient.
- These batteries are overcharged.
- The results of the experiment are inaccurate.

#### b) more categorically.

EXAMPLE: *I believe that he will become a good specialist.*

He is sure (certain) to become a good specialist.

- I believe that this problem is of vital importance.
- We suppose that electric cars will find a wide application.
- We assume that hot water will be supplied by solar thermal heating systems.
- We think these new car batteries are long lasting.

### VIII. Restore the original sentences.

- are known, semiconductors, to be made of, silicon
- numerous, to offer, solar heaters, seem, advantages
- efficient, to be, this method, proved, very
- citizens, the solar village, to inhabit, ordinary, are likely
- he, to adjust, is believed, the solar batteries, in this car
- valuable, this new substance, to possess, is sure, properties

### IX. Correct mistakes.

- The engineers was expected to take into account variations in the intensity of sunlight.
- Young specialists known to be professionals in their field.
- The system reports to be pollution-free.
- The water seem to be heated naturally.
- The nuclear power stations were turned out to be dangerous.
- Max is believing to study theoretical mechanics.
- We are likely exhaust our fossil fuels quickly.
- This information said to be of utmost importance.
- Before the race any driver sure to fuel his car.



**X. Choose the correct translation for the underlined part of the sentence.**

- The scientists are said to be developing solar thermal heating systems nowadays.  
a) разработали b) разрабатывают
- They seem to have improved previous results.  
a) улучшают b) улучшили
- An experimental solar heating systems proves to have been built in this region.  
a) строится b) был построен
- Our total solar energy consumption is estimated to be increasing.  
a) увеличивается b) увеличится
- The research is reported to have been carried out successfully.  
a) было проведено b) будет проведено
- The sufficient amount of electricity is likely to be generated by a small windmill.  
a) вырабатывается b) вырабатывает

**XI. Translate the sentences into English using your active vocabulary.**

- Известно, что отдельный фотоэлемент производит 0,5V.
- Сообщается, что ученые скоро разработают новый источник энергии.
- Предполагается, что потребление энергии будет увеличиваться.
- Говорят, что вода в солнечных домах будет нагреваться естественным образом.
- Наверное, солнечная энергия в будущем заменит даже топливо для машин.
- Считается, что альтернативные источники энергии экологически чистые и неистощимые.
- Оказалось, что некоторые материалы на свету производят электрический ток.
- Похоже, ваш проект имеет ряд преимуществ.

**Reading and Speaking**

**I. We are likely to suffer from fossil-fuel shortage in the near future. What do you know about the use of solar energy?**

**II. Scan the article to get the answers to the following questions.**

- What source of energy is used to light the Olympic torch?
- What is the total solar energy consumption in Australia?
- What are the ways to obtain solar energy?

- How is sunlight converted into electricity?
- How much electricity is generated in the solar village?
- Why are collectors normally dark?
- Are solar heaters efficient?
- What is the purpose of solar furnaces?

**III. Read the article attentively for more information about solar energy.****Olympic Solar Energy**

Four months before the start of the Sydney games, Olympic officials stood with a magnifying lens in the ancient temple of Zeus in Olympia, Greece - the site of the first Olympic Games. Like the original Olympians, they focused the rays of the Sun onto dry grass in order to make it burn, and from that 'Mother Flame' the Olympic torch was lit.

As the lighting of the Olympic flame shows, the solar energy that strikes the Earth is tremendous, despite travelling nearly 150 mln km across space to get here. In fact, every minute enough energy arrives at the Earth to meet our demands for a whole year. However, we do not use it efficiently. For example, Australia is estimated to consume only 0.02% of the solar energy that falls on it annually.

**Capturing Energy from the Sun**

Solar energy can be collected in three main ways: photovoltaic (PV) cells, solar collectors and solar furnaces. The first are used to convert sunlight directly into electricity. They are known to be the first power introduced in 1958 in order to seem to run everything from lighting systems to water pumps not to mention pocket calculators. At the Sydney Olympic village more than 8,000 kilowatts of electricity. All houses in the Olympic village have PV cells built into the roof, to make the most of sunlight that falls on them.

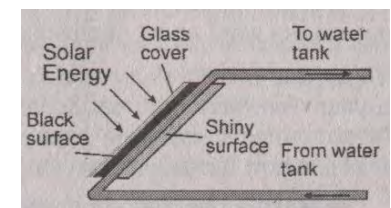

Hot water for the village is supplied by solar thermal heating systems. Such systems include solar panels on the roof and large solar collectors. These are normally dark in order to absorb more sunlight. Their surface is covered with glass to let in the rays but hold heat. The heat is transferred to water, which runs through small

pipes. The hot water is then circulated through the house. Solar thermal heaters are believed to reduce water-heating costs by about 50% as some still use natural gas as a back up on cloudy days. It is estimated that 40 million solar heated buildings will be constructed in the near future.

Solar furnaces use a huge array of mirrors to concentrate the Sun's energy into a small space and achieve temperatures up to **33,000°C**. They are likely to be used for scientific experiments but they are also known to generate electricity.

The Olympic village is likely to be converted to housing for ordinary citizens now the games are over, and the houses are expected to generate electricity for years to come. The village is one of the largest housing developments in the world to use solar electric power.

#### IV. Explain why ...

- 1) the officials used a lens in the temple,
- 2) the torch is lit in the temple of Zeus,
- 3) Australia consumes so little solar energy,
- 4) solar cells are built into the roofs of houses,
- 5) collectors become very hot,
- 6) solar heaters sometimes use natural gas,
- 7) solar furnaces achieve such high temperatures,
- 8) ordinary citizens will live in the solar village.

**V. How has the use of photovoltaic cells in the Olympic village helped to spread the word about photovoltaic power systems?**

**VI. a) Your friend volunteered to live in an experimental solar village for a year. You have decided to visit him to see how he is going on. Your friend seems to be quite happy. He is glad to show you around and explains how things work as you seem to be very interested in details.**

**b) Make a brief report on what you have found out.**

---

### Further Reading

---

**I. Do you believe that one day stopping for petrol is likely to become a thing of the past? Why?**

**II. Look at the headline of the article and try to guess what information it contains. Skim the article to check your guess.**

**III. Read the article attentively for more detailed information about solar-powered cars.**

### Solar-powered Cars

One of the ways we can reduce the amount of pollution from traffic seems to power our vehicles using renewable resources. To demonstrate this, the World Solar Challenge Car Race from Darwin to Adelaide annually involves dozens of cars that are powered only by the energy of the



Sun. The cars are reported to use photovoltaic (PV) cells to convert sunlight into electricity. A single PV cell is known to produce only a small amount of electrical power (approximately 0.5 volts). To increase the power, lots of PV cells are connected together to make a 'solar panel'. Panels can be linked to form a large solar array that is certain to produce enough electricity to power a car.

When the World Solar Challenge teams design their electrical systems they have to take into account variations in the intensity of sunlight. The Sun's energy is supposed to power the car's motor and also charge a battery for use at night or at times when the Sun is hidden by a cloud. If a car is designed to put all its energy toward driving and keeps nothing in reserve, it is sure to stop completely in cloudy weather. If too much energy is diverted to the battery, the engine is found to run too slowly.

Engineers still have many questions and problems to tackle before solar power becomes an efficient and economical way to fuel vehicles. Today's solar-powered cars are rather expensive but as the pressure on fossil-fuel resources is certain to increase scientists will continue to search for alternative energy sources, including harnessing the Sun's energy to drive vehicles. The most fascinating part of using solar power as an energy source is that it is considered to be pollution-free and inexhaustible. If research continues, stopping for petrol is likely to become a thing of the past.

**IV. Say if the following statements are true or false. Correct the false statements.**

1. Energy from renewable sources is reported to cut pollution.
2. Only solar-powered cars are reported to take part in the World Solar Challenge Car Race.
3. The intensity of sunlight is sure to be taken into consideration when electrical cars are designed.
4. A solar-powered car is unlikely to operate in cloudy weather.

5. The overcharged battery doesn't let the car win the race.
6. Many problems still have to be solved.
7. Solar power as an energy source appears to have no particular advantages.
8. Alternative energy sources are expected to replace fossil fuels in the future.

**V. Fill in the table below and decide what is better at the moment: a traditional car or a solar-powered car. Which vehicle would you like to have? Why?**

	<i>Advantages</i>	<i>Disadvantages</i>
Traditional car	... ...	pollutes the atmosphere ...
Alternative car	pollution-free ...	... ...

---

## Activity

---

**I. An automobile engineer has designed a new vehicle, which runs on solar energy. He turns to a manufacturer in order to start a large-scale production of such vehicles.**

*Student A.* You are an automobile engineer. Think of advantages and possible disadvantages of the car you have designed. Prove to the manufacturer that it is very efficient.

*Student B.* You manufacture cars running on petrol and/or diesel. Remember their pluses and minuses. Discuss with the engineer his invention and take a decision.

You can start like this:

- Sir, I would like to discuss with you the following question...

**II. Discuss in small groups the possibility of constructing an experimental solar village in your country.**

*Optimists:* you see only advantages in this project. Prove that the village is worth building. *Pessimists:* you believe that the project is a no-go. Defend your opinion.

## Writing

I. Write an advertisement of a solar village. You can begin like this:

Tired of smog and dirt? Looking for fresh air and a clean spot to live?  
Welcome to the Solar Village! ...

II. Translate the passage into Russian. Use the dictionary if necessary.

### The Photovoltaic Effect

In 1839, a French scientist Edmond Becquerel was reported to discover the photovoltaic (PV) effect. 'Photovoltaic' means turning light into electricity. PV cells work like leaves of a tree. Leaves convert the Sun's energy into chemical energy during photosynthesis. Similarly, PV cells capture the sunlight and turn it into electrical energy.

The materials used to make PV cells are called semiconductors. They are likely to be made from silicon. This is a very plentiful material - in fact, every grain of sand is estimated to contain silicon in the form of silicon dioxide, SiO<sub>2</sub>.

*How a PV cell works.* When photons (tiny, individual packets of light energy) strike a cell, some are absorbed. Each transfers its energy to an electron in an atom. The electron now has enough energy to break free of its atom and can move away. The cells are made in two layers, one is more positively charged than the other. The negatively charged electrons move towards the positive layer. Thus, an electric current is formed.

# Unit Fifteen

## ENGINEERING PROBLEMS

---

### Section A. Energy Problems

#### Lead-in

---

I. Discuss the following questions.

- What do you know about the energy crisis we are facing today?
- What solutions can you offer?

II. Listen to the students' discussion and name advantages and disadvantages of alternative energy sources

*Sveta:* Alex, I would like you to read this article. It seems to be very interesting.

*Alex:* Does it really? What's so special about it?

*Sveta:* Well, you had better read it by yourself. Anyway, it appears to discuss the energy crisis threatening us today.

*Alex:* Oh, I hear something about it. We consume too much energy and exhaust our fossil fuel resources consisting of oil, coal and gas. However, technological progress cannot be stopped.

*Sveta:* Don't worry. The solution is likely to be found anyway. Have you heard about alternative energy sources developed by the scientists all over the world?

*Alex:* Certainly, these alternative sources of energy are assumed to have many advantages, but actually they are very expensive and rather inefficient.

*Sveta:* Well, the new method only needs perfection. Besides, as we are sure to run out of fossil fuels soon, do we have other options?

*Alex:* No, we don't. And moreover, the alternative sources of energy seem to be inexhaustible and causing no pollution.

*Sveta:* That speaks for itself, doesn't it?

*Alex:* Without any doubts. OK, where is the article? I need further information.

*Sveta:* Here it is.

III. Complete the following dialogues.

- a) -Alex, ...to skim this article .....  
 -...? What's ...about it?  
 - ..., it seems to ... the problem of ....  
 - ... interesting.
- b) - I'm afraid we are sure to ...  
 - No need to worry. The scientists are ....  
 -Are these ... ?  
 - Not yet, but... to improve.
- c) - ... are considered to have many ..., aren't they?

A	B
1. to civilize	-civilization, civil, sensible, unsuitable
2. to consume	-converter, conservation, consumption, measurement
3. use	-consumer, usable, reduction, increase
4. short	-report, comfort, ensure, shortage
5. power	-empire, powerfully, sensible, waterwheel
6. to suit	-consist, student, suitable, institute
7. to exhaust	-example, inexhaustible, exhibition, explanation
8. to pollute	-plant, pursuit, production, pollution

- Yes, certainly. ... pollution-free and ... .  
 - ... disadvantages?  
 - ..., they are said to be ... .

**IV. Match a line in A with a line in B.**

- | A  |
|--|
| 1. This article seems to be very interesting.                |
| 2. Could you tell me what the article is about?              |
| 3. We are facing an energy crisis today.                     |
| 4. What is so advantageous about alternative energy sources? |
| 5. We don't have other options, do we?                       |
| 6. Am I right?   |

Language Practice

*Vocabulary*

**I. Match the English words with their Russian equivalents.**

essential	нар
steam	десятилетие
available	почти
reason	неотъемлемый
evident	постоянно
nearly	доступный
decade	причина
constantly	очевидный

**II. Match the words with the opposite meaning.**

to accelerate	to excess
adequate	pollution free
renewable	inexhaustible
polluting	inadequate
safe	to slow down
shortage	unsuitable
expensive	nonrenewable
suitable	dangerous
exhaustible	cheap

**III. Find in B the derivatives from the words in A.**

*Grammar: Participle*

**IV. Express the same idea in a shorter way.**

EXAMPLE: *The engineers who researched fossil fuels came to disappointing results.*

The engineers researching fossil fuels came to disappointing results.

- In the future we are certain to have vehicles that will move at a greater speed.
- The student, who is controlling the work of a relay, does not follow safety rules.
- The person who changes a burnt bulb must switch off the power first of all.
- In the laboratory I found students that were studying the work of a switching device.
- Windmills that make. 100 kW can provide enough electricity to power several houses.
- Man that consumes a lot of energy is faced with the energy shortage.

**B**

- Don't worry. The scientists are sure to solve the problem.
- I think not.
- Does it really?
- Without any doubts.
- Well, you'd better read it by yourself.
- They seem inexhaustible and pollution-free.

**V. Join these sentences into one.**

EXAMPLE: *Students were carrying out a test in the lab. They were discussing it.*

They were discussing the test being carried out in the lab.

1. The battery is producing a current. I'd like you to measure it.
2. Engineers are constructing solar villages worldwide. They are very economical.
3. Man is exhausting fossil fuels quickly. They are not likely to last long.
4. They are tackling the energy problem now. The problem is of great importance.
5. The teacher is checking an electric circuit. It is broken.
6. Olga is connecting the coils to a battery. They are made of copper.

**VI. Provide more detailed information.**

EXAMPLE: *Scientific investigations were of great value. (to carry out in this lab)*

Scientific investigations carried out in this lab were of great value.

1. The new properties of engineering materials have been discussed at the last seminar. (to refer to at the lecture)
2. The results of the check of the complete electric circuit have revealed many faults. (to describe in the engineer's report)
3. Numerous advantages of a new personal computer interested scientists from different countries. (to enumerate in the report)
4. The lecture that was followed by a demonstration of interesting data. (to obtain during a set of experiments)
5. The car does not pollute the environment. (to supply with solar batteries)
6. Robots have made our life much easier. (to develop recently)

**VII. Expand the sentences.**

EXAMPLE: *The experiment completed showed good results.*

The experiment that was completed showed good results.

1. The method used facilitated the finding of a broken part of an electrical circuit.
2. The lecture delivered dealt with the work of a relay.
3. The material investigated belonged to the conductors of electric current.

4. The measures taken helped him to avoid a short circuit.
5. The results obtained made the researchers continue the investigation.
6. The answer received was not satisfactory.

**VIII. Choose the right option.**

1. The engineers *tackling/tackled/being tackled* the energy problem did not reach a compromise.
2. The equipment *delivering/delivered/being delivered* yesterday has just been installed.
3. The coils *connecting/connected/being connected* to each other will be attached to a battery through an on-off switch.
4. Tests of the properties of the electromagnetic circuit *carrying/carried/being carried* out by this team have shown good results.
5. The high voltage circuit *checking/checked/being checked* now will be used soon.
6. Many people are against power plants *burning/ burnt/being burnt* waste.

energy crisis prospects  
steam engine  
oil-equivalent

**IX. Open the brackets and use Participles in the right form.**

1. Scientists (to deal) with solar energy have made great progress.
2. The investigation (to carry out) by the students now is very interesting.
3. The bulb (to turn) into the socket burnt out at once.
4. The project (to discuss) by the engineers at the moment has numerous advantages.
5. The professor (to deliver) a lecture on the use of solar energy provided working models.
6. In Japan there are many villages (to use) geothermal energy of the Earth for heating.

X. Correct mistakes.

1. I saw Boris being repaired an electrical device in the lab.
2. Serious faults finding in the project had to be corrected quickly.
3. A new method of investigation using gave unique results.
4. The Sun radiated a tremendous amount of energy provides us with

everything.

5. Vehicles driving automatically will appear on the market soon.
6. Water and wind power using extensively today seem to be inexhaustible.

#### XI. Translate the sentences into English using your active vocabulary.

1. Студенты, наблюдавшие за работой электрического реле, сейчас находятся в мастерской.
2. Электроприборы, установленные в лаборатории, будут использоваться студентами во время практики.
3. Количество энергии, потребляемой цветным телевизором за год, составляет 93 кВт.
4. Метод превращения солнечной энергии в электричество, разработанный этим ученым, очень эффективен.
5. Человечество, потребляющее огромное количество энергии, скоро столкнется с энергетическим кризисом.
6. Биомасса, сжигаемая для получения энергии, является не истощимым энергетическим ресурсом.

## Reading and Speaking

I. What do we need energy for? Make a list of the uses of energy and compare it with that of your partner.

II. Translate the following compound nouns into Russian.

energy cost  
total fuel consumption  
overall energy supply

III. Scan the text to find answers to these questions.

1. How did primitive man get the energy he needed?
2. How much energy does man consume today?
3. What does technological man do half of his life?
4. In what two ways is energy used?
5. What is the standard measurement of energy cost?
6. Does the car require much energy?
7. Why is it essential to cut energy consumption?
8. What is the primary source of energy?

IV. Read the article carefully for the details about the energy problems.

Energy is an essential part of our civilization. A million years ago primitive man used only 6,000 (kJ) a day, which he got from the food he ate. A hundred thousand years ago people had learnt to make fire

and used four times as much energy (the equivalent of 25,000 kJ). By the 15th century man using animals, windmills and waterwheels, and

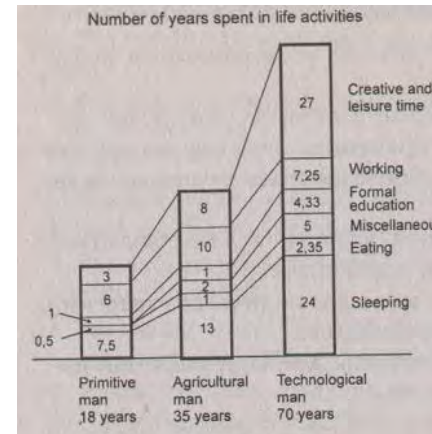

a little coal, was already consuming- nearly twenty times as much energy (120,000 kJ). By 1875 the steam engine made 340,000 kJ a day available to industrial man in England. Today's technological man uses 1,000,000 kJ a day, or one hundred and fifty times as much as primitive man, about one third in the form of electricity.

Why is our energy consumption constantly increasing and accelerating? The reasons are evident. Technological man lives four times as

long as primitive man and twice as long as man in the 15th century. Nearly half of man's life today is spent on educating himself, leisure and creative activities. Medieval man spent only a quarter of his thirty-five years in these pursuits, and primitive man only one sixth in his short life of eighteen years.

What do we need energy for? Comfort and lighter work, first of all. Energy consumed in great quantities falls into two kinds: a) energy needed every day (lighting, heating, etc.) and b) energy used to produce necessary objects (house, clothes, etc.). Take a man building a small house (10 tons of oil-equivalent), heating (3 tons of oil-equivalent) and lighting (200 kg of oil-equivalent or 700 kWh) it for a year and having a car (1.3 tons of oil-equivalent + 1.3 tons for every 12,000 km run). The energy cost of these basic things is tremendous but multiply it by 6 billion to get the real picture of man's needs. Besides, energy consumption is sure to increase since the more energy is consumed, the easier our life becomes.

The current energy problem caused by many interrelated factors must be tackled quickly. Strange as it sounds, there is no shortage of primary energy. The sun provides ten thousand times as much energy as we require today, in many forms ranging from solar radiation through wind and waves to trees and plants. The problem is to convert these resources into mechanical work or other usable forms of energy. The history of energy has been the history of converters - man's body itself converting food into warmth and mechanical work, animals doing such work more powerfully, the waterwheel, the windmill, the steam engine, the nuclear reactor and in the near future, the solar cell.

V. Read these figures: 6,000; 100,000; 340,000; 1/2; 1/3; 1/4; 1/6; 1.3; 700; 1,000,000. What do they refer to?

**VI. Complete the table with the information from the article.**

<i>Time</i>	<i>Man</i>	<i>Years of life</i>	<i>Energy consumption</i>	<i>Why?</i>
...	...	...	...	...

Consider food, domestic consumption, services (trade, office work, teaching, leisure), industry and agriculture, transport.

**VII. a) Study the diagram in the text and discuss these questions with your partner.**

1. What goes under the heading 'Miscellaneous'?
2. Do you observe any interesting tendencies?
3. Can you explain why it takes us more time to do these activities? Compare the columns.
4. Why do we spend less time on work and more time on leisure than, say, agricultural man?
5. Why do we live longer?

**b) Continue the diagram and draw the fourth column for the Man of the Future. Point out how long he will live, what activities he will have and how much time they will take. Give reasons for your forecast. Discuss it with your group and try to come to a general agreement.**

**VIII. Expand the following situations.**

1. What are the ways of using energy? Supply your own examples.
2. How much energy (in oil-equivalent) is necessary to build a house and light and heat it for a year?
3. What is the energy problem? Describe its causes and ways of solving it.
4. Continue the sentence: The less energy we will use, the .... Do you agree? Give reasons for your opinion.
5. What energy sources on the Earth are or have been provided by the Sun?

**IX. a) Does the article provide any interesting information? What is the main**

idea of the article? What other questions does it discuss?

**b) Give a title to the article.**

**Further Reading**

**I. What alternative sources of energy do you know? List as many as you can and compare your list with that of your groupmate.**

**II. These words are taken from the text. Use the dictionary to find out their meanings.**

- |                  |                |
|------------------|----------------|
| dam, n           | cane, n        |
| flood, v         | sugar cane     |
| land, n          | plant, v       |
| rough, adj       | wrong, adj     |
| underground, adj | go wrong       |
| poisonous, adj   | drive, v       |
| dung, n          | drive smb nuts |

**III. Read the text for detailed information about alternative sources of energy.**

Alternative Sources of Energy

It is not a secret that energy consumption has increased immensely in the last decades. But do we have enough fossil fuels to satisfy our needs? As fossil fuels are nonrenewable we are highly interested in developing alternative sources of energy.

Solar Power is renewable. It is used for heating houses. Solar cells and furnaces make electricity from sunlight. Solar cells are expensive. Solar power isn't much use unless you live somewhere sunny. It doesn't cause pollution and doesn't need fuel.

Wind Power is renewable as well. It doesn't cause pollution; doesn't need fuel. However, a lot of generators are needed to get a sensible amount of power. It is necessary to put them where winds are reliable. And the noise can drive you nuts.

Hydroelectric Power plants are built for getting energy from flowing water. Usually we build a dam, and let the water turn turbines and generators as it goes through pipes in the dam. Renewable. No pollution, no fuel needed, no waste. Very expensive to build. Building a dam we flood a lot of land.

Waves Power. There's a lot of energy in waves on the sea. However it is not easy to get it. A wave power station needs to be able to stand really rough weather, and yet still be able to generate power from small waves. This source of energy is renewable - the waves will come whether we use them or



not.

58

Geothermal Energy means heat from underground hot rocks. Hot water comes up and we use the heat to make steam to drive turbines, or to heat houses. It is renewable - so long as we don't take out too much, the energy keeps on coming. However, there are not many places you can do it - the rocks must be suitable. Sometimes we get poisonous gases coming up too.

"Biomass" means burning wood, dung, sugar cane or similar. It is renewable - we can always plant more trees. We burn the fuel to heat water into steam, which drives turbines, which drive generators. Burning anything we pollute the environment.

Nuclear (atomic) power stations use uranium as fuel. It is nonrenewable. Heat from the reactor turns water into steam, which drives turbines, which drive generators. It doesn't cause pollution unless something goes wrong.

**IV. Answer the following questions.**

1. Why do we have to develop alternative sources of energy?
2. What is solar energy used for?
3. What are the disadvantages of wind power?
4. What requirements should hydroelectric power stations meet?
5. Why can the use of geothermal energy be dangerous?
6. Are nuclear power plants considered safe?

**V. Name the sources of energy that are ...**

1. renewable,
2. pollution-free,
3. producing no waste,
4. needing no fuel,
5. safe.

**VI. Can these sources of energy be used in your country? Give your reasons.**

<i>Power Source</i>	<i>Can Be Used</i>	<i>Cannot Be Used</i>
solar power		
wind power		
hydroelectric power		
waves power		
geothermal power		
biomass		
nuclear power		

**VII. What new or useful information have you learnt from the text?**

## Activity

Your country is running out of fossil fuels soon and is facing an energy crisis. Other sources of energy must be developed quickly. Divide into several groups.

### a) Discussion.

*The Government:* state the problem; announce the award for the best project.

*The Engineering groups:* carry out your research, consider all the factors (both positive and negative) and suggest a power plant to be built.

### b) Presentation.

*The Engineering groups:* present your project; explain your choice and answer possible questions.

*The Government:* ask the engineers questions after their presentation, choose and award the best project with a prize.

## Writing

**I. We are surrounded by electrical appliances and take modern conveniences for granted, ignoring the fact that we are rapidly exhausting our energy resources. Write a paragraph discussing the following questions:**

1. What electrical appliances do you have at home?
2. How much electricity do they consume?
3. Is it possible to reduce their energy consumption? If so, how?
4. Why is it important to save energy?

**II. Translate the passage into Russian. Use the dictionary if necessary.**

### Glowing in the Dark

Have you ever wondered why a TV-set being already switched off is glowing in the darkness? The same effect may be observed with a fluorescent lamp in a darkened room. With the light switched on, cover the eyes with a hand to shut out the light. Then count off 15 to 25 seconds, switch off the light, and open the eyes quickly. The tube will be seen glowing, the glow gradually but quickly disappearing.

This phenomenon is explained as follows. The light given off by a fluorescent tube is produced when the electric current flows through a gas containing a small amount of mercury. The light produced is ultra-violet, not suitable as room illumination. But ultra-violet light shines on a coating inside the tube, a coating made of phosphors, substances that glow with different colours when excited by ultra-violet light. The ultra-violet light goes out as the switch is turned off, but the phosphors continue to glow briefly. Different phosphors give off different colours, and the tube uses phosphors emitting light visible to the eye and suitable for illumination. The picture of your TV-set is also made by phosphors that can be seen to glow briefly after the set is turned off.

## Section B. Automotive Problems

### Lead-in

**I. Discuss the following questions.**

- a) Are you good at repairing cars?
- b) What are the most common faults in a car?
- c) Do you know how to repair them?

**II. Listen to the students' conversation and learn what faults can occur in a car.**

*Peter:* Alex, I would like you to have a look at my car, please. *Alex:* What's wrong with it?

*Peter:* I don't know. Having just started the engine stops again. *Alex:* There is no petrol in the tank, I'm afraid. *Peter:* On the contrary! The tank is full and the battery seems to be in order.

*Alex:* Let's go into the garage then and ask Denis to have a look at it. He is said to be a good car mechanic and is sure to find the fault in your car.

*Peter:* OK. Considering the situation, we are going to need his help.

*(a couple of hours later)*

*Peter:* What are you busy with?

*Denis:* I'm repairing the engine of your car.

*Peter:* But what has happened? It's quite new as far as I know.

*Denis:* Don't you understand that you should never operate the engine if the air filter is out of order? Well, having entered the engine, dust and dirt damaged the cylinders, pistons and piston rings.

*Peter:* OK, I get it, I should have changed the filter.

*Denis:* Yes. By the way, have you ever checked your spark plugs?

*Peter:* Let's see... But they are as good as new!

*Denis:* Certainly, they are all right. Having cleaned and tested them, I only have to repair the engine now.

*Peter:* Oh, now it's clear why there was no spark.

*Denis:* And there wouldn't be. Being covered with oil the spark plugs will not give a spark. That's why your engine stops.

*Peter:* I see.

III. Complete the following dialogues.

a) - Vlad, ...?

- ...

- What's wrong with it?

- ...

b) - ...

- The tank is full, I have checked it.

- What about the ...?

- ...

c) - Well, let's go into the garage and ...

- Is he good at repairing cars?

- ...

-OK. ...

d) - **The engine seems completely** ... . What can it be?

- Look here, the spark plug is ...

-... The car won't start as ... .

III. Match a line in A with a line in B. A

A

B

1. My car doesn't start.

2. I think there is no petrol in the tank.

3. What are you busy with?

4. The engine is out of order.

5. Have you checked the spark plugs?

6. The battery must be flat.

a) Not yet.

b) But I have just charged it!

c) No wonder, the pistons are damaged.

d) I'm changing the air filter.

e) What's wrong with it?

f) On the contrary! It is full.

## Language Practice

### Vocabulary

I. Find the English equivalents in **B** to the Russian words in A.

A	B
1. количество	a) amount    b) quality    c) count
2. чистить	a) to change    b) to block    c) to remove
3. свободный	a) difficult    b) easy    c) free
4. увеличивать	a) to reduce    b) to decrease    c) to increase
5. примесь	a) starter    b) particle    c) spark
6. тщательный	a) clockwise    b) thorough    c) backwards
7. ремонт	a) overhaul    b) research    c) maintenance

II. Match the words with the similar meaning.

to damage	to get into
downwards	ordinary
to change	free
impurity	to break
common	to overhaul
unobstructed	to replace
to enter	dust and dirt
to repair	down

III. Complete the table with the missing words.

	Verb	Noun
заводить (мотор)		
		absorption
	to radiate	
		circulation
охлаждать		
	to conduct	

## Grammar: Participle

### IV. Make all possible sentences, matching the actions that take place at the same time.

EXAMPLE: *to repair the car / to follow the mechanic's instructions*  
(When) repairing the car I followed the mechanic's instructions.

to park your car  
to maintain the car in order  
to press the accelerator  
to push a car forwards and backwards  
to introduce automated vehicles  
to drive a car  
of traffic

to remember about the speed limit  
to start the engine  
to save yourself a lot of trouble  
to consider road signs  
to keep the distance  
to take into account the safety

### V. Explain why these things happen.

EXAMPLE: *The spark plugs gave a spark at last. (to clean)*  
Being cleaned the spark plugs gave a spark.

1. The engine needs cooling. (to heat)
2. The ammeter is recording no current. (to break)
3. The moving parts work almost without friction. (to oil)
4. Solar-powered systems operate at night. (to supply with batteries)
5. The project promises good results. (to design carefully)
6. The car needs a serious overhaul. (to damage)

### VI. Expand the following sentences as shown in the example.

EXAMPLE: *When removed the particles of dirt can't cause damage.*  
When the particles of dirt are removed, they can't cause damage.

1. If tested the engine may be started.
2. When repaired and repainted, the car looked as good as new.
3. If removed impurities cannot block the carburettor.
4. When removed from the pump, the filter is cleaned with a brush.
5. If added to the engine, oil decreases friction between the moving parts.
6. When adjusted properly, the spark plugs produce a spark.

### VII. Study the following sentences and point out the differences in their translation.

1. a) A car running on hydrogen was invented long ago.  
b) Running on hydrogen this car is not likely to cause pollution.

2. a) Students attending classes regularly study better.  
b) Attending classes regularly students understand the material quicker.
3. a) The exhaust system being repaired at the moment produces too much smoke.  
b) Being repaired by a skilful mechanic the exhaust system is now in order.  
c) If not repaired the exhaust system will have to be replaced.
4. a) When redesigned the engine will perform better.  
b) Being redesigned completely the engine became more efficient.  
c) The engine redesigned and improved by the researchers showed excellent performance.

### VIII. If none of the switches are working something must be wrong with the electrical system in the car. Say in what order you will check its components. Work in a chain.

Begin like this: Having noticed a fault in the electrical system of my car I will turn the engine on. Having turned the engine on I will turn it off again. Having ...etc.

Your actions: to switch on the lights;  
to switch them off;  
to press the horn button;  
to push the indicator lever to the left;  
to push the lever to the right;  
to stop the indicator;  
to switch on the engine again;  
to press the brake pedal;  
to release the pedal;  
to switch off the ignition;  
to ask the mechanic for help.

### IX. Match the beginning of each sentence with its end.

- |  |   |
|--|---|
| 1. Having been cleaned                           | a) the participants of the conference were surprised. |
| 2. Having been repaired by a good mechanic       | b) I had to pay the fine for speeding.                |
| 3. Having been stopped by a policeman.           | c) the car needed a serious overhaul.                 |
| 4. Having been damaged badly                     | d) the filter increased the airflow.                  |
| 5. Having been shown the results of the research | e) the car was as good as new.                        |

**X. Fill in the gaps with the words given in the box.**

clockwise, anticlockwise, to the right, to the left, in front of, upwards, downwards, forwards, backwards

1. To start the car the key should be turned ....
2. Take the first turn ..., the second ... and you will see the service station ... you.
3. If the starter is jammed you should try to push the car ... and ... .
4. It is necessary to turn the bulb ... in order to take it out of the socket.
5. The pistons in this car move ... and ....

**XI. Translate the sentences into English using your active vocabulary.**

1. Устранив неисправность, водитель уехал со станции техобслуживания.
2. Проверяя тормозную систему машины, механик обнаружил дефект,
3. Попав в двигатель, сор и пыль повредили цилиндр и поршневые кольца.
4. Будучи серьезно поврежденной, машина не заводилась.
5. Удаляя различные примеси из воздуха, фильтр не дает карбюратору засориться.
6. После того, как свечи зажигания были зачищены, они дали искру.
7. Заметив, что топливо заканчивается, он остановился на заправочной станции, чтобы наполнить бак.
8. Регулярно проходя техосмотр, вы экономите, по крайней мере, время и деньги.

---

## Reading and Speaking

---

**I. Look at the headline and try to guess what the text is going to be about.**

**II. Scan the text to find the answers to the following questions.**

1. Do modern cars need servicing regularly?
2. What are the three most common faults in the car?
3. What should you do if the battery appears to be dead?
4. What does a fuel warning light show?
5. Why is there no spark sometimes?
6. What is likely to happen to the petrol pump?
7. How can the fuel pipe become blocked?
8. How do you know that the starter motor is likely to be jammed?
9. Is the air filter an important part of the engine?

**III. Read the text attentively and learn about the most common faults in the car and the ways to repair them.**

## Finding a Fault in the Car

Servicing your car regularly you prevent it from becoming unreliable. Of course, you can't foresee everything. Having failed to start the car in the morning you had better check three things first: the battery, the fuel level and the spark plugs. It is quite easy to repair these faults.

If the battery appears to be flat it is necessary to recharge it. If this doesn't work, you should replace it.

An empty tank is another common fault in the car. Having noticed a fuel warning light on the instrument panel of your car you should fill up the tank with more petrol.

Dirty spark plugs are also certain to cause a problem. To drive the car it is important to clean them regularly and adjust the gap in the spark plugs to the proper width. If the gap is not correct the engine will not run well.

If your car still does not start, the petrol pump may be broken, or the fuel pipe may be blocked. Having discovered a broken pump, it is a good idea to repair or replace it. If the fuel pipe is blocked, take it off and unblock it.

Having heard a loud CLICK! when you turn the key, you are sure to realize that the starter motor may be jammed. If it is, you can try to release it pushing the car forwards and backwards (in the 2nd gear). If the car still doesn't start, the starter motor should be repaired or even replaced.

And don't forget about the air filter. Its function is to remove particles of dirt, dust and other impurities from the air passing to the carburettor. A blocked filter decreases the airflow to the carburettor thus increasing the amount of fuel in the mixture. This causes the engine to operate inefficiently. Cleaning and changing filters regularly you prevent a considerable damage that is certain to be caused inside the cylinders. In this case the engine will need a thorough overhaul.

If you are a poor mechanic, stopping at service stations periodically you will save at least time and money. As they say, prevention is better than cure.

**IV. Do you recognise these parts of the car engine? Find their names in the text.**

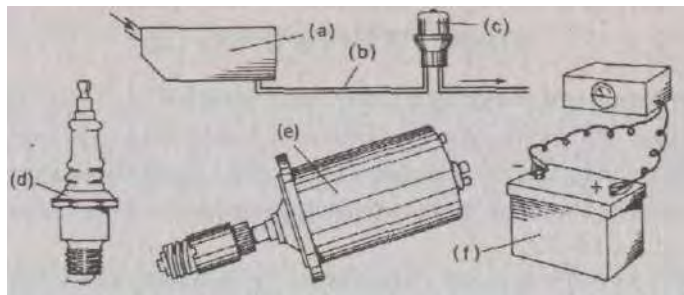

**V. Fill in the table with the data from the text.**

A component of the car	The fault	What to do
1. the battery	flat	...
2. ...	...	...
...	...	...

**VI. You are studying to get a driving license. The topic of the lesson today is 'Maintenance of a Car'. Your friend is your instructor. Ask him about the most common faults in the car and the ways to repair them.**

You can start like this: - What shall I do if the car doesn't start?  
- Well, you should ...

**VII. Expand this gist of the text.**

The text deals with common faults in the car and ways to repair them. Special emphasis is laid on the necessity of regular car servicing.

## Further Reading

**I. The cooling system is a necessary component of any engine-driven vehicle. Why is it important to cool the engine? How can the engine be cooled?**

**II. Scan the text to get the answers to these questions.**

1. Why does the engine become very hot?
2. How much energy pushes the pistons?
3. What are the two functions of the cooling system?

4. How are motorcycles usually cooled?
5. What increases the efficiency of air-cooling?
6. Why is liquid-cooling preferred to air-cooling in large engines?
7. Where is hot fluid cooled in the car engine?
8. What liquids are used in the cooling system?
9. What requirements must the coolant meet?

**III. Read the text attentively for more details about cooling systems.**

### 1. Cooling Systems

When you drive a car, the engine becomes very hot. Why?

Burning in the engine the fuel-air mixture produces energy. But only a *quarter* of this energy makes the pistons move. *Most* of it turns into heat. *About half* of this heat goes down the exhaust pipe and *the other half* stays in the engine making it very hot. In fact, the cooling system on a car driving down the freeway dissipates enough heat to heat two average-sized houses! The primary job of the cooling system is to cool the engine and to keep it from overheating. However, the cooling system also has several other important jobs. The engine in your car runs best at a fairly high temperature. When the engine is cold, components wear out faster, and the engine is less efficient and emits more pollution. So, another important job of the cooling system is to allow the engine to heat up as quickly as possible, and then to keep the engine at a constant temperature. There are two types of cooling systems found on cars: air-cooled and liquid-cooled.

### 2. Air Cooling

Some older cars, very few modern cars and most motorcycle have air-cooled engines. Constructing the engine block covered in numerous external aluminum fins engineers greatly increase its surface area, which can be cooled by the flow of air passing over it. A powerful fan is used to supply an increased amount of air for cooling multi-cylinder engines. The forced airflow conducts heat away from the cylinders radiating it into the air more efficiently.

However, it is difficult to design large engines with an unobstructed airflow over all the cylinders. The alternative is a liquid (water)-cooling system.

### 3. Liquid Cooling

Most cars are equipped with liquid-cooling systems. Flowing around the *engine* the fluid absorbs its heat, which consequently allows the engine to get cooled. Then, having entered through the *top*

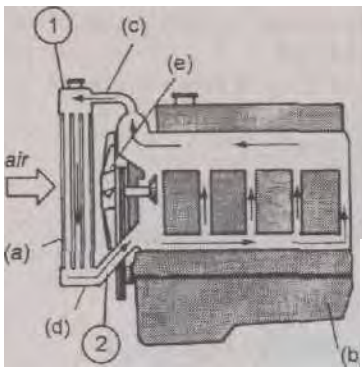

hose the hot fluid passes through the heat exchanger or *radiator*. The radiator transfers the heat from the fluid to the air pulled through the exchanger by a *fan*. Leaving the radiator through the *bottom* hose the cooled fluid is pumped around the engine again.

Cars operate in a wide variety of temperatures. So whatever fluid is used to cool the engine it has to have a very low freezing point, a high boiling point, and it has to have

the capacity to hold a lot of heat. Water holds heat quite effectively, but it freezes at too high a temperature to be used in car engines. The coolant used in most cars is a mixture of water and ethylene glycol ( $C_2H_6O_2$ ), also known as antifreeze. Adding ethylene glycol to water, the boiling and freezing points are improved significantly.

**IV.** When burning the fuel-air mixture produces a lot of energy. Where does 25% / 75% / 37.5% / 38.5% of the initial amount of this energy go?

**V.** Name the objects in the picture in the text. Use the words in italics from paragraph 3.

**VI.** Point out the functions of the following objects.

EXAMPLE: The function of the engine is to move the vehicle.  
a fuel-air mixture, the cooling system, the coolant, a top hose, a fan, a pump

**VII.** You are taking a test for a driving license tomorrow. Today you have a consultation. Your friend is your instructor.

*Student:* Prepare a list of questions concerning cooling systems and ask the instructor for explanations.

*Instructor:* Look at the picture again and explain the operation of the cooling system to your student.

## Activity

I. Discuss in small groups what system is better: air-cooling or water-cooling. Consider advantages and disadvantages of both.

II. a) What are these objects called? You can choose from the following:

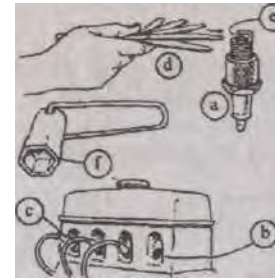

- 1) cover
- 2) spark plug
- 3) socket
- 4) spanner
- 5) gap

6) gauge

b) Complete the instructions with the words given above.

### How to Check a Spark Plug

First you should remove the cover. Having achieved this, place the ... over the spark plug. Then it is necessary to rotate the ... anticlockwise until it seems to be loose. Having removed the plug from the ..., examine the gap and check it to be clean. After that, insert a ... in the gap. Check that the ... is between 0.65 and 1.00 mm wide. Having replaced the plug in the socket you should rotate it clockwise until it is hand-tight. Next, it is necessary to place the spanner over the plug and give ONLY a quarter turn clockwise. Caution should be taken not to overtighten the plug. Finally, replace the ....

III. Solve the puzzle.

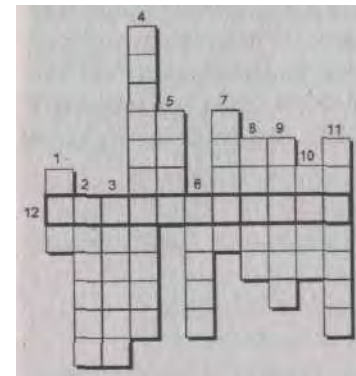

*Down:*

1. part of a cooling system;
2. ordinary, conventional;
3. it can be either positive or negative;
4. part of the engine where fuel is mixed with air;
5. petrol, diesel, gas;
6. the fuel warning light shows that the tank is ...;
7. dirty spark plugs cannot produce it;
8. if you want to stop you should push it;
9. gasoline;

10. a device to produce a sound signal;
11. you should do it to keep your car reliable.

*Across:*

12.?

## Writing

- I. You are a mechanic at the service station. Write a set of instructions 'How to maintain a car'.
- II. Translate the passage into Russian. Use the dictionary if necessary.

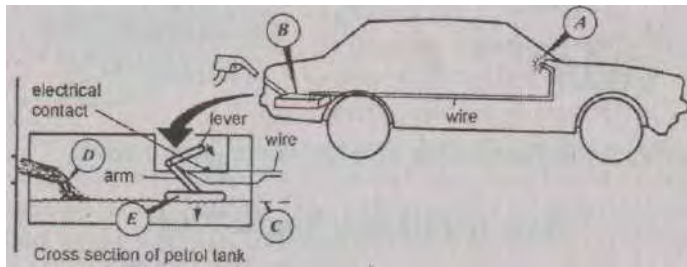

Having noticed it on the instrument panel of your car you start looking for a petrol station. What is it? Certainly, a fuel warning light (A). Its function is to prevent your stopping in the middle of the road with an empty tank (B).

The light switches on in order to enable the driver to see when the level of fuel (C) in the tank becomes critical. What makes this light work? The tank is equipped with a special float (E) indicating the level of the fuel in it. When falling, the level of the fuel causes the float to move downwards. This makes the arm go down as well allowing the lever to touch an electrical contact and thus switching on the fuel light in the car. Having noticed the fuel warning light the driver should put more petrol (D) into the tank. When rising, the fuel level pushes the float up. Being forced upwards the float moves the arm in the same direction (up) raising the lever. This consequently breaks the electrical contact switching off the fuel warning light on the instrument panel of the car.

## Unit Sixteen

### ADVANCES IN TECHNOLOGY

#### Section A. Holograms

##### Lead-in

I. Discuss the following questions.

- a) Have you ever seen a hologram? What is it?
- b) Where are holograms used nowadays? Make a list of their possible applications and compare it with that of your partner.

II. Listen to the students' conversation and learn how holograms are made.

*Nick:* Sveta, I'm looking for Boris. Have you seen him today?

*Sveta:* Yes, he is making a hologram in the lab.

*Nick:* Is he? And what is a hologram?

*Sveta:* Look at your watch! See? A hologram is a three-dimensional image. It is produced when laser light is recorded on a holographic plate.

*Nick:* I can't imagine Boris experimenting with a laser beam.

*Sveta:* Well, just ten minutes ago I saw him splitting the laser beam into two separate beams by means of a beam splitter.

*Nick:* As far as I can see, it's rather difficult to make a hologram.

*Sveta:* Oh, it is not. If you have all necessary equipment you can make holograms at home.

*Nick:* Really? What equipment do I need?

*Sveta:* Well, the easiest hologram requires a laser, a lens, a holographic plate, a stable table, a dark room with green safe-lights and a holographic model. Of course, you are supposed to know what to do with this equipment.

*Nick:* Right. Where can I learn how to make holograms?

*Sveta:* If you are so interested, you can join our Science Club. By the way, Boris is still in the lab. You can watch him producing a hologram right now.

*Nick:* Indeed. See you at the Club tomorrow then.



### III. Complete the dialogues,

a)- I wonder, ... now.

- ...
- What is he doing there?

- ...

b) - I suppose it is not easy to ...

- Why?... I have just seen ...
- ... ? It is difficult to imagine ...

- ...

c)- ...

- A hologram is ...
- Can it be **produced at home**?...
- What equipment do I need?
- Well, ...

### IV. Match a line in A with a line in B.

#### A

1. Where is Denis?
2. It's rather difficult to make a hologram, isn't it?
3. I can't imagine Paul experimenting with a laser beam.
4. Holograms can be made at home.
5. You can watch me doing a hologram right now.
6. Thank you for the information.

#### B

- a) Oh, really?
- b) In the lab.
- c) Indeed.
- d) Neither can I.
- e) You are welcome.
- f) Actually, no.

## Language Practice

### Vocabulary

#### 1. Find in B the English equivalents to the Russian words in A.

##### A

1. пленка
2. видимый
3. разбивать
4. одноцветный
5. отражать
6. первоначальный

##### B

- |               |              |                  |
|---------------|--------------|------------------|
| a) image      | b) film      | c) coating       |
| a) visible    | b) seen      | c) sensitive     |
| a) to split   | b) to remove | c) to record     |
| a) ultrasonic | b) sound     | c) monochromatic |
| a) to reflect | b) to emboss | c) to belong     |
| a) first      | b) original  | c) early         |

### II. Match the words with the similar meaning.

- |               |               |
|---------------|---------------|
| visible       | single-colour |
| to separate   | to coat       |
| monochromatic | whole         |
| to light      | spectator     |
| to cover      | viewable      |
| image         | to split      |
| complete      | to illuminate |
| viewer        | picture       |

### III. Divide these words into four columns according to their part of speech.

normally, theorist, originally, incidentally, imperfect, achievement, considerably, numerous, vibrate, viewable, spread, reflection, viewer, multidimensional, specialize, holographic, sensitive, interference, monochromatic, insulate, typically, directly, split

### Grammar: Participial Constructions

#### IV. These two sentences have a different structure but the same meaning. Change the structure of the sentences below so as to keep their meaning unchanged.

EXAMPLE: *We found that a laser beam is split by means of a beam-splitter device.*

*We found a laser beam being split by means of a beam-splitter device.*

1. We found that a laser beam is split into two separate beams.
2. The students assumed that laser beams are reflected off the two mirrors.
3. She supposed that one of the laser beams is reflected off the mirror onto the holographic plate.
4. You heard how the teacher was explaining the properties of a laser beam.
5. I'd like to watch how they are working with a holographic plate.
6. We consider that a hologram is a three-dimensional image.

#### V. Say what you saw (heard, noticed, observed, watched, found) these people doing yesterday.

EXAMPLE: *Boris - to explain the way of doing a hologram.*

I saw Boris explaining the way of doing a hologram.

the engineers	to demonstrate real-image holograms;
the students	to carry out the analysis of the data with the help of a computer;
the chief engineer	to speak about the prospects of holography;
the students	to test a beam-splitter;
my friend	to work with holographic lenses;
the teacher	to record laser light on a holographic plate

**VI. Change the structure of these sentences so as to keep their meaning.**

EXAMPLE: *It is found that a laser produces a powerful beam of light.*  
A laser is found producing a powerful beam of light.

1. It is known that lasers produce multidimensional images.
2. It is found that a laser beam is split into two beams.
3. It is assumed that holograms are widely used in industry.
4. It is believed that this group of researchers experiments with a new type of a hologram.
5. It is considered that this scientist applies advanced methods of research.
6. It is observed that the student explains the principles of hologram production.

**VII. Say how you want these things changed.**

EXAMPLE: A: *The laser is out of order (to fix)*  
 B: I'd like to have (see, get, etc.) the laser fixed.

1. The beam-splitter has gone wrong (to test).
2. The hologram has been badly produced (to reproduce).
3. The green safelights are out of order (to repair).
4. The dimensions of the object are badly measured (to measure them again).
5. The equipment for making a hologram is not ready yet (to prepare).
6. The TV-set is producing a lot of noise (to switch off).

**VIII. Restore the original sentences.**

1. being made, to see, I'd like, a hologram
2. properties, having, this group of substances, valuable, is considered
3. many faults, is assumed, having, the device
4. is found, the splitter device, many advantages, revealing
5. reported, the engineers, improving, the quality of a hologram, are
6. being, the wavelength, short, extremely, is known

**IX. Split these complex sentences into simple ones using suitable conjunctions. Pay attention to the translation of Absolute Participial Constructions into Russian.**

EXAMPLE: *A hologram is a three-dimensional image, special equipment being necessary to produce it.*  
 A hologram is a three-dimensional image and special equipment is necessary to produce it.

1. A holographic plate is a piece of glass coated with a substance, the latter being sensitive to light.
2. The first beam is reflected off the mirror onto the holographic plate, the second beam being reflected onto the object.
3. One beam is called the reference beam, the other being called the object beam.
4. The analysis of the new data having been carried out, the researchers made an interesting report.
5. A beam-splitter having been repaired, the students began to make a hologram.
6. The experiments having been carried out, the students started a new series of tests.

**X. Translate the sentences into English using your active vocabulary.**

1. Если один луч лазера отражается от объекта, другой луч отражается от другого зеркала на голографическую пластину.
2. Голограмма - это отражение в 3-х измерениях, причем для его получения необходимо специальное оборудование.
3. Мы наблюдали, как студент проверял электрическую цепь.
4. Преподаватель смотрел, как мы создавали голограмму.
5. Выяснилось, что лазерный луч расщепляется на два отдельных луча.
6. Мы видим, как инженер использует лазер, чтобы сделать голограмму.

## Reading and Speaking

**I. Translate the following compound nouns into Russian.**

electron microscope	rainbow hologram
light source	quality control
laser light	stress analysis

**II. Technological progress supplies us with unusual things and holograms are a good example. Scan the text to find answers to these questions.**

1. What is the difference between holography and a hologram?
2. Who discovered the holographic effect?
3. How was the word *hologram* coined?
4. What was the aim of Dennis Gabor's research?
5. Was the aim achieved?
6. Why were first holograms imperfect?
7. When was the first laser operated?
8. What are the basic types of holograms? ,

**III. Read the text attentively to learn more about holography.**

### Holography and Holograms

History. Holography and hologram are normally referred to as a process and as a plate or film itself respectively. In 1947 Dennis Gabor (the father and the first theorist of holography, awarded with the Nobel prize for his research) coined the term *hologram* from the Greek words 'holos' meaning *whole* or *complete* and 'gram' meaning message. Gabor's theory was originally intended to increase the resolving power of electron microscopes. Incidentally, it was proved not with an electron beam, but with a light beam. The result was the first hologram ever made. Gabor's hologram was clear, but imperfect, as he lacked the correct light source - the LASER, which was first seen operating in 1960.

Types. The latest achievements in laser technologies being applied, holography has developed considerably. Numerous types of holograms can be noticed operating everywhere. The following are considered the most frequent:

- a) transmission holograms. They are viewable with laser light when both beams approach the film from the *same* side;
- b) reflection (white-light) holograms. These are viewable with white light from a suitable source (spotlight, flashlight, the sun, etc.) when both beams approach the film from the *opposite* sides;
- c) multiple-channel (rainbow) holograms. These holograms with several images are not only visible from different angles; they also change colour at each new angle;
- d) real-image holograms. They produce the image *in front of* the plate towards the viewer. Most holograms in holography museums are of this type.

Application. Holography being an art that attracts people's attention and curiosity, colourful multidimensional images are widely used in advertising, stamps, jewelry, with holography museums exhibiting masterpieces. Credit cards are considered original if supplied with a hologram. Holographic lenses are lighter than traditional lenses and mirrors and can be designed to perform more specialized functions, for instance, to make the panel instruments of a car visible in the windshield in order to increase safety. Holographic interferometry (a very precise technique used for measuring changes in the dimensions of an object) is widely used in industrial stress analysis and quality control. The list of applications may be continued indefinitely.

**IV. Complete the table below with the data from the text.**

<i>Type of a Hologram</i>	<i>View</i>
...	...

**V. Where is holography used nowadays? Can you continue the list of applications? Where is holography likely to be applied in future? Give reasons for your opinion.**

**VI. You are very interested in holograms. Your friend is taking a course on holograms at the Science Club. Ask your friend what he has already learnt about holography.**

**VII. Your friend happened to miss the first lecture on holography. He wants to know the information delivered. What will you tell him?**

---

### Further Reading

---

**I. Match the following noun compounds with their Russian equivalents.**

- |                         |   |
|-------------------------|---|
| 1. laser beam           | a) интерференционная картина                  |
| 2. beam splitter        | b) луч лазера                                 |
| 3. reference beam       | c) разделитель луча/светоделитель/расщепитель |
| 4. object beam          | d) опорный луч                                |
| 5. interference pattern | e) объектный луч                              |

**II. Do you know how holograms are made? What equipment is necessary for this? Study the picture and say what the text is going to be about. What other information can it provide? Skim the text to check your guess.**

III. Read the text attentively to find out how holograms are made.

### How Holograms Are Made

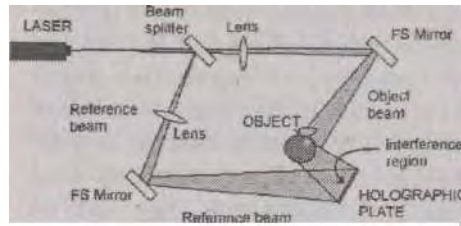

A hologram is a three-dimensional image, special equipment being necessary for producing it. A hologram is created when laser light is recorded on a holographic plate (a piece of glass coated with a substance, sensitive to light). The laser beam

is split into two separate beams by means of a device called a beam splitter. One beam is reflected off the mirror directly onto the holographic plate, while the other beam is reflected off another mirror onto an object. The former is called the reference beam, the latter being called the object beam.

When reflected off the object onto the holographic plate, the object beam meets the reference beam and an "interference pattern" is produced. It is this interference of the two beams that is recorded on the plate to produce a hologram.

If a hologram is illuminated in the direction of the reference beam, a three-dimensional image of the object appears where the object was originally. Some holograms are viewed with laser or monochromatic (single-colour) light, others with white light.

Holograms being mass-produced, it is advisable to divide them into categories:

- *embossed holograms*. These are stamped on foil backed Mylar film using a metal master (most common method).
- *polymer holograms*. These are made from light sensitive plastic. The Polaroid Corporation mass produces holograms by this method.
- *dichromate holograms*. Very bright holograms on jewelry, watches, etc., which are recorded on a light sensitive coating of gel containing dichromate.

Holograms can be homemade as well. The easiest type of holography for amateurs requires a holographic model, a stable table, a laser, a lens, a holographic plate and some darkroom supplies (e.g. green safelights). Freedom from any (air and sound) vibrations within millionths of a centimeter must be assured. The greater the number of optical components, the greater the destructive effect of vibrations. One more thing must be always kept in mind - SAFETY RULES.

IV. Answer the questions using the data from the text.

1. A hologram is a three-dimensional image, isn't it?
2. In what way is a hologram made?
3. How many beams is the laser beam split into?
4. What are the functions of these two separate beams?
5. What are the two beams called?
6. How is 'interference pattern' produced?
7. Is the interference of the two beams recorded on the plate?
8. How can a hologram be viewed?

V. What are the categories of holograms? Fill in the table below.

Category	Material	Usage
...	...	...

VI. Explain why ...

- 1) you need green safelights when making a hologram,
- 2) the table used should be stable,
- 3) there must be no movement in the room while producing a hologram.

VII. Can you shortly describe the process of creating a hologram? Use the diagram for help. Do you think it is difficult to make a hologram at home? Give reasons for your opinion.

### Activity

I. Students in the lab are discussing how to make a hologram.

*Student A:* You want to make a hologram but are not very sure of your skill. Ask your friend for help and more information.

*Student B:* Explain to your friend how a hologram is made. Give him instructions how to produce a hologram.

II. You had a unique chance to visit the world-famous Science Museum at Exhibition Road, London, during your winter holidays. The Holographic Gallery attracted your attention. Now you are back home. Tell your friend what you have seen and learnt at the exhibition.

### III. Solve the puzzle.

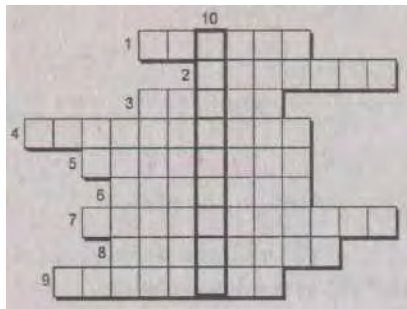

#### Across:

1. a person who watches sth. happening; a spectator;
2. temperature changes and noise cause the air to ...;
3. complete, not broken or split;
4. the degree of clearness with which objects can be seen according to air or weather conditions;
5. a person who consumes goods or services;

6. a covering of a surface, can be insulating;
7. when an object is used everywhere it is said to have a wide ...;
8. a device for recording;
9. first, earliest, new, not copied.

Down:

10.?

## Writing

**I. Write a 'How to Make a Hologram' guide for those who want to create holograms at home. Cover the following questions.**

1. What is a hologram?
2. How is it created?
3. What special equipment is necessary?
4. What must everyone remember while making a hologram?
5. Where can holograms be applied?

You can start like this:

1. A hologram is a three-dimensional image. It is created when laser light ...
2. To produce a hologram at home ...
3. ...

**II. Translate the passage into Russian. Use your dictionary if necessary.**

Holograms possess a unique property - each small portion of a hologram contains information about the whole object. Let's consider a simple example. A unique 11 x 14" hologram of a George Washington bust is wanted by two museums. They decide to cut it horizontally and exactly through the middle. In this way each

museum has a representation of the whole bust, unchanged in size but viewed from different angles. The hologram is like a window into the room containing the bust. If the window is made smaller, the object does not reduce in size. We just have a narrower angle of view of the object. You will see, for example, the hat, even from the bottom part of the hologram; however, you may not see the very tiptop of the plume from the reconstructed angle of view of the lower part. This is because the light from that point cannot spread enough to reach and interfere with the reference beam at the bottom of the plate. Placing the object farther back from the film you can improve the view but it recedes from your personal three-dimensional world.

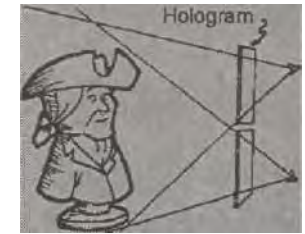

## Section B. The Age of Robots

### Lead-in

**I. Take a piece of paper and within one minute put down your associations with the word 'robot'. Compare your ideas with those of your groupmates.**

**II. Listen to the engineers' conversation and learn about the latest achievements in robotics.**

*Chief Engineer:* Look, Andrew, I've got terrific news for you.

*Engineer:* Oh really? What is it?

*Chief Engineer:* We've received a grant from the government for buying new equipment for our research laboratory. I suggest buying a robot.

*Engineer:* That's a good idea. And I think we should buy a robot called ASIMO.

*Chief Engineer:* ASIMO?

*Engineer:* Yes, it's an up-to-date model capable of performing various tasks, such as walking, talking, moving different objects from one place to another.

*Chief Engineer:* Are there any difficulties in operating this robot?

*Engineer:* No, I don't think so. It's one of the latest achievements in robot technology. So there shouldn't be any problems.

Chief Engineer: And what about compiling programmes for it?

Engineer: Oh, you don't need to compile any programmes, as they are ready-made on disks. Besides, you have a possibility of switching to another programme without using additional controlling devices.

Chief Engineer: That sounds interesting. We'll be able to continue our research on artificial intelligence then.

Engineer: OK then, settled.

### III. Complete the dialogues.

a) - Have you heard the news?

- ... What is it?

- We are going to receive ... and obtain ...

- Is this robot worth buying?

- ...! It is a brand-new ...

b) - ...?

- No difficulties at all! It is the latest...

- .... Do you have to compile ...?

- No need. ...

- Does it require many additional devices?

- ...

- That sounds fascinating. When do we continue ...?

- ...

### IV. Match a line in A with a line in B.

#### A

1. Why is this robot worth buying?

2. What can this robot do?

3. What do you suggest doing with the grant received?

4. Are there any difficulties in operating this device?

5. What about compiling programmes for the robot?

6. How do you switch from one programme to another?

#### B

a) No need. They are ready-made on disks.

b) Buying new equipment for the lab.

c) None.

d) Without using additional devices.

e) It is an up-to-date model.

f) Well, it is capable of performing various tasks, like walking, talking and moving objects.

## Language Practice

### Vocabulary

#### I. Match the words with the similar meaning.

precise	evidence
capable	surroundings
creature	able
data	one more
clever	exact
additional	to carry out
to perform	being
environment	intelligent

#### II. Make up all possible word combinations.

artificial	intelligence
intelligent	creature
precise	definition
dangerous	task
repetitive	environment
humanoid	robot
to imitate	humans
conscious	instructions

#### III. Find in B the derivatives from the words in A.

#### A

1. to supervise

2. to exist

3. to invent

4. to define

5. to manipulate

6. to repeat

7. to explore

8. to sense

#### B

- pressure, supervision, ultrasonic, suggestion

- exit, existence, exhibition, exactly

- intention, invention, infrared, internal

- definition, defusing, despite, deformation

- medieval, man-made, manipulator, numerous

- report, preparation, action, repetitive

- expensive, exploration, conscious, extremely

- suitable, considerable, sensor, intelligence

## Grammar: Gerund

### IV. How do you find these ideas? Use the table to make your own sentences and express your opinion.

EXAMPLE: In my opinion, the idea of performing operations in this way is quite new.

the idea		compiling new			important
the method		programmes	is		simple
the way		exploring space	seems	very	specific
the purpose		calculating the	appeared	quite	obvious
the necessity	<i>of</i>	dimensions	sounds	rather	modern
the importance		supervising	proved		necessary
the technique		robots			strange
		imitating			
		humans			
		using robots			
		gathering data			

### V. a) Say if it is impossible (hard, difficult, easy, etc.) to do these things.

EXAMPLE: *to carry out underwater welding / to use robots*  
It is hardly possible to carry out underwater welding without using robots.

to calculate at high speed / to apply a computer  
to make further experiments / to estimate the results obtained  
to control this robot / to reprogramme  
to make the robot move / to use actuators  
to make exact measurements / to use a laser  
to apply new technologies in industry / to test them first

### b) Name 5 actions we cannot live without.

### VI. Do (or would) you mind doing these things? Explain why not.

EXAMPLE: *to experiment with a laser*  
I don't mind experimenting with a laser because it is very interesting.

to have a robot at home  
to watch the Skyworker robot in operation  
to develop robotics further  
to explore distant galaxies with the help of robots  
to test artificial intelligence  
to create a child robot

### VII. Discuss the following questions with your partner. Pay attention to the use of prepositions with gerunds.

EXAMPLE: *How did they improve the results of the first experiment?*

They improved the results of the first experiment by doing further research.

1. What are robots capable of?
2. What do some researchers insist on?
3. What are remote control devices Used for?
4. What do scientists object to?
5. What have the latest developments in science resulted in?
6. What did different scientists receive the Nobel prize for?

### VIII. Restore the original sentences.

1. it is worth, devices, buying, high-quality
2. on completing the test, results, found, the researcher, interesting
3. is not, compiling, a complex task, a programme
4. carrying out the test, must, the operator, before, prepare, all necessary equipment
5. insisted on, the teacher, the lab work, our carrying out, immediately
6. analysing, we, interested, this phenomenon, were, in

### IX. Insert prepositions (*at, of, without, instead of*) if necessary.

1. People get tired ... doing the same work for a long time.
2. Science is worth ... developing.
3. Intelligent machines are clever ... performing various tasks.
4. What is the use ... creating playing robots?
5. You had better check the calculations ... doing another test.
6. Quick processing of information is impossible ... applying computers.
7. They suggest... using another actuator.

### X. Correct mistakes in the following sentences.

1. I know everything of their researched artificial intelligence.
2. Scientists invented a new way investigating space.
3. The engineers object-carrying out the experiment.
4. He will be quite capable to do all the calculations by himself.
5. The idea of use robots for performing difficult tasks is extremely old.
6. Do you mind of my testing the new robot?
7. Without analyse evidence you will result in making mistakes.

**XI. Translate the sentences into English using your active vocabulary.**

1. Стоит ли покупать это оборудование? - Да, безусловно. Я даже настаиваю на его покупке.
2. Робот - это устройство, способное выполнять действия самостоятельно.
3. Если вас интересует выполнение подсчетов, вам лучше использовать персональный компьютер.
4. При анализе данных исследователи получили интересные результаты.
5. Составление программы - задача достаточно сложная.
6. Данный метод решения этой проблемы является наилучшим.
7. Это открытие привело к получению очень важных данных.
8. Вы не против, если я проведу этот эксперимент? - Безусловно, нет.

---

## Reading and Speaking

---

**I. These words are taken from the text. Use the dictionary to find out their meanings.**

defuse, v	qualify, v
smith, n	salary, n
ashtray, n	solder, v
turn on smb, v	dull, adj
take over sth, v	teammate, n

**II. You already know quite a lot about robots. Discuss the following questions with your friend.**

1. What is a robot?
2. What does the word 'robot' mean?
3. When did first robots appear?
4. What are the most common applications of robots today?

**Scan the text to check your answers.**

**III. Read the text attentively to find something new about robots.**

### Robots in Perspective

If you think robots belong to space movies, think again. Right now, all over the world, robots are on the move. Putting chocolates into boxes, walking into live volcanoes, driving trains in Paris and defusing bombs in Northern Ireland are their common tasks. Today's robots are doing more and more things humans can't do or don't want to do.

The idea of creating an intelligent machine is very old. Homer described gold girls, mechanical helpers built by Hephaistos, the Greek god of smiths. In 1495, Leonardo da Vinci designed a mechanical man. But only the invention of transistors and integrated circuits in the 1950s and 1960s made real robots possible. Compact, reliable electronics and computers added brains to already existing machines. In 1959, researchers demonstrated the possibility of robotic manufacturing ashtrays.



The Czech word 'robota', meaning hard work, was first used by the writer Karel Chapek in the story where robots are invented to help people by performing simple tasks, but being used to fight wars, they turn on their human masters and take over the world.

There's no precise definition of a robot. It is normally defined as a programmable machine imitating an intelligent creature. Getting information from its surroundings and doing something physical (moving or manipulating objects) qualify a machine as a robot.

Name a boring or dangerous job. Somewhere, a robot is probably doing it. Robots are ideal for doing jobs that require repetitive, precise and fast movements. Robots are good at doing the same thing without asking for a safe working environment, salary, breaks, food and sleep, without getting bored or tired, without making mistakes. Factories are so highly automated that most human workers carry out only supervising and maintaining the robots.

People keep finding new uses for robots - making and packing drugs and foods, soldering tiny wires to semiconductor chips, inserting integrated circuits onto printed circuit boards used in electronics, working in radioactive "hot zones", exploring space.

All work and no play make anyone dull - even a robot. Soccer-playing robots gather each year at RoboCup, an international event collecting over 100 teams from 35 countries. Robotic players use radio signals to coordinate their actions with their teammates. Teams are placed in divisions based on size, ranging from the size of a pizza box. By 2050, the organizers of RoboCup count on developing a team of fully autonomous humanoid robots that can beat the human world champion team in soccer.

**IV. Provide extensive answers to the following questions.**

1. Can you prove that robots belong not only to space movies?
2. What were the first ideas of a robot?



3. Why did real robots appear only in the late 50s?
4. Who coined the word 'robot'?
5. What is the idea of K. Chapek's story?
6. Why is there no exact definition of a robot?
7. What two factors determine a robot?
8. Have robots replaced man in all kinds of activities?
9. What are the basic applications of robots? Where else can they be used in the future?
10. How do robots play soccer?

**V. Will you agree to these statements? Give reasons for your opinion.**

1. Right now, all over the world, robots are on the move.
2. The idea of creating an intelligent machine is very old.
3. Name a boring or dangerous job. Somewhere, a robot is probably doing it.
4. All work and no play make anyone dull - even a robot.
5. Robots will replace professional sportsmen in the future.
6. Robots must not be allowed to compete with humans.

**VI. Have you heard K. Chapek's story, in which robots turned out to be dangerous for man. Nevertheless, robots are found increasingly replacing man in various activities. Discuss the problem with your partner who has a different opinion. Can you reach a compromise?**

*The optimist:* you believe robots are safe, useful and have a great future.

*The pessimist:* you do not like the idea of artificial mind and find robots too dangerous to be developed and applied further.

**You can begin like this:**

- Hello, ... Why are you so happy?
- Haven't you heard the news? We have got a brand-new robot for our lab!
- Oh...

## Further Reading

**I. These words are taken from the text. Use the dictionary to find out their meaning.**

ultrasonic, adj	corresponding, adj
navigate, v	exposure, n

infrared, adj	response, n
gearbox, n	detect, v
linear, adj	pursue, v

**II. Look at the photos attentively. What is the text going to be about? Skan the text to find answers to these questions.**

1. What kind of machine is a robot?
2. What can a robot sense?
3. What are the functions of the light sensors?
4. How does a robot 'see'?
5. What is the difference between a robot and a computer?
6. Is the actuator a device for thinking?

**III. Read the text more attentively to learn more about robots.**

### Advances in Robotics

A robot is a machine that gathers information about its environment (senses) and uses that information (thinks) to follow instructions to do work (acts).

Imitating humans, robots also sense magnetic fields and ultrasonic waves. Robotic light sensors work by creating or changing an electric signal when light falls on them. When navigating, the robot sends out a beam of infrared light, which bounces off objects and returns to a light sensor of the robot. However, making 3D images requires large amounts of computer memory.



The ability to move sets robots apart from computers. A mechanical device for producing motion is known as an actuator. A single robot is supplied with dozens of actuators, each chosen to do a specific task. Electric motors are actuators that produce motion from electricity by the electromagnetic effect. Their high speed and a small turning power make a gearbox necessary. Special stepper motors turning in precise 'steps' are ideal for adjusting position. A servomotor is used for turning only 90° to the right or left. If you've ever driven a toy car, boat, or plane by remote control, a servomotor was probably responsible for the steering. Solenoids are electric motors for producing linear, or in-and-out motion. Solenoids are used in switches turning things off and on. Although making a robot move like a person is not easy, engineers at Honda have designed robots capable of walking, climbing stairs and keeping their balance - no two-legged robot has ever done it before.

How to make robots think? There are three approaches to artificial intelligence.



Most robots have a microcomputer for 'brains', which allows programming a lot of information. But they work only according to their programme and cannot learn. Neural networks are modelled after the human brain. A neural net 'learns' by exposure to lots of input and corresponding output. Once trained, the neural net responds to an input with a likely output. Unlike rule-based systems, neural networks are incapable of giving definite answers.

Stimulus-response robots pioneered by Rodney Brooks at MIT have no memory and no logical decision-making - only hard-wired responses to stimulation.

Can a robot be conscious in the way that we are? So far, no artificial intelligence has ever shown such signs of life. However, if robots eventually think like us, detect and express emotions, pursue their own interests and even make copies of themselves, drawing the line between machines and living things will be increasingly difficult.

**IV. What is necessary to create moving robots? Fill in the table with the data from the text.**

<i>Mechanism</i>	<i>Function</i>
Actuator	...
...	...

**V. Will you agree with the following statements? Give your reasons.**

1. It is impossible to create thinking machines.
2. The three approaches to artificial intelligence are all imperfect.
3. 'Computer brains' have numerous disadvantages.
4. Neural networks are modelled after the human brain but they are worse than rule-based systems.
5. Stimulus-response robots 'live and learn' like children. This makes them dangerous as it is difficult to foresee their reaction and they can get too clever.

**VI. You are taking part in the students' conference devoted to the latest achievements in technology. Deliver a report on the topic 'Robots - humans with artificial intelligence'.**

## Activity

**I. Most people find robots dangerous. They have good reasons to think so. How will you comment on the idea of this paragraph? Would you like to have such a future?**

Silicon-based life forms are seen by some as the next step in evolution, replacing carbon-based life forms like us. Robots becoming more intelligent and capable, we can soon be out of control. However, if robots do develop consciousness, they may also develop conscience and choose to be kind to their human creators. In the meantime, we may want to remember where the 'off-switch' is ... just in case.

**II. Robotics is a quickly developing science. It certainly brings advantages but also puts difficult questions. Here are some of them. Discuss these questions in small groups.**

1. If in the future machines have the ability to think, be conscious and have feelings, then what makes a human being a human being, and a robot a robot?
2. Would you like to have a robot to do any task you like or do not want to do yourself? If yes, how do you think this can affect you as a person?
3. Are there any kinds of robots that shouldn't be created? Why?
4. Do you think the development of new technologies, and their application, are inevitable? Should we do anything for the people who will lose their jobs when replaced by robots? If yes, what?
5. Do you think a special law on robots must be made? Will you agree with these *Three Laws of Robotics*, 'created' by Isaak Asimov?
  - a) A robot may not injure a human being or, through inaction, allow a human being to come to harm.
  - b) A robot must obey the orders given to it by human beings, except where such orders conflict with the first law.
  - c) A robot must protect its own existence, as long as this does not conflict with the first two laws.

## Writing

**I. Study the example and write your own advertisement of a new model of a robot.**

## A Robot's Best Friend



Tired of walking your dog and finding its hair everywhere? Sony's robotic dog, AIBO, may be for you.

AIBO is a totally autonomous robot capable of hearing and seeing, sensing balance and touch. Eighteen specialized motors allow such dog-like motions as rolling over, scratching, playing dead, and chasing a pink ball. Like a puppy, with time and training AIBO develops perfect movements and unique behaviour patterns. Programmed to seek companionship, AIBO simulates emotions like happiness, surprise, and anger and is clever at responding to verbal commands.

### II. Translate the passage into Russian. Use the dictionary if necessary.

Some scientists predict that advances in robotics, genetic engineering and nanotechnology will lead to a world populated by superorganisms both biological and mechanical. When we built machines that are like us, only smarter, stronger and more easily produced, they say, we are in fact creating our own worst enemy. These machines will develop new forms of thinking that will be beyond our comprehension. If we can't understand what we have built, we will not be able to control it. The scientists say that we have some 20 years of intellectual superiority over computers. By that time the robots will have learnt a lot. They will deserve the same rights and privileges because they will be like humans.

We're probably decades away from having to worry about! anything more than running out of batteries. Still, it seems clear that big changes are coming, and as with any new technology, there will certainly be some unintended, and quite possibly unpleasant, consequences as robots begin to play a regular role in our day-to-day lives. But the potential benefits outweigh the risks. Let's hope that the society is strong and wise enough to stop abuses without stopping science.

# Unit Seventeen

## DANGERS OF NEW TECHNOLOGIES

---

### Section A. Laser

#### Lead-in

##### I. Discuss the following questions.

- What is a laser? Where are lasers applied?
- Are lasers dangerous? If so, give your reasons.

##### II. Listen to the conversation and learn what a laser is and how it works.

- Teacher:* Hello, my friends. Today, I'm going to show you an operating laser.
- Ivan:* That's great! By the way, what does the word 'laser' mean?
- Teacher:* It denotes light amplification by stimulation of emission of radiation. Looking at the operating laser one can see it producing a very powerful beam of light.
- Ivan:* When did the first lasers appear, I wonder?
- Teacher:* As far as I know, in the 1960s. Yet, we hear of their having numerous applications. Industrial welding, cutting materials, making measurements, etc. will be practically impossible without this device.
- Ivan:* And how do lasers work?
- Teacher:* Their work is based on the principle of amplifying the light of a certain wavelength in the resonator cavity.
- Ivan:* I'm rather interested in making experiments with laser beams.
- Teacher:* Then let's try to make one. But be very careful. Lasers can be very dangerous.
- Ivan:* Why are they dangerous?
- Teacher:* Well, they produce a very powerful beam of light and if treated in the wrong way it can hurt or even kill you.
- Ivan:* Oh, I'm pretty scared.
- Teacher:* Don't worry. If you follow all the safety instructions nothing will happen to you.

### III. Complete the dialogue.

- We are going to ..., aren't we?
- ... .But first, I'd like you ... questions. To begin with,...?
- The word 'laser' ...
- OK. Then...?
- A very powerful ...
- The first ..... they?
- No, you are ... . They appeared about... ago.
- And ... many uses?
- Without any doubts. ...
- I also would like you ...
- Oh, that is easy .... is in the basis of laser operation.
- I see. Why are lasers considered ...?
- ...
- That's pretty scary.
- ...
- Fine.

### IV. Match a line in A with a line in B.

#### A

1. Are lasers amplifiers or oscillators?
2. What is an oscillator?
3. What is an amplifier?
4. What makes lasers dangerous?
5. What are lasers used for?
6. When does the laser become a source of destruction?

#### B

- a) It is a device for increasing the strength of a signal.
- b) Welding, cutting, holography.
- c) It is a generator or source of light.
- d) Oscillators.
- e) When treated inadequately.
- f) Their producing an extremely powerful beam of light.

4. majority, n
5. amplifier, n
6. to emit, v
7. monochromatic, adj
- d) an apparatus for producing a very hot narrow beam of light used for cutting metals
- e) acting in a particular way
- f) a hole or hollow space in a solid mass
- g) an instrument for making a signal stronger

### II. Match the words with the similar meaning.

- |                |            |
|----------------|------------|
| synthetic      | feature    |
| exactly        | powerful   |
| characteristic | usage      |
| application    | to offer   |
| to suggest     | to possess |
| single         | artificial |
| strong         | precisely  |
| to have        | separate   |

### III. Find in the list these parts of speech.

- (noun) amplify, weak, absorption, to treat  
(noun) partially, excited, bounce, pulse  
(adjective) activate, solution, flat, principle  
(adjective) tiny, purify, majority, totally  
(adverb) intense, forth, numerous, since  
(adverb) powerful, infrared, exactly, cavity  
(preposition) input, actually, via, ultraviolet  
(verb) radiation, synthetic, reflective, manipulate  
(verb) emit, unique, oscillator, quality

## Grammar: Gerund and Participle I

### IV. Continue the sentences in two possible ways.

EXAMPLE: *experimenting with lasers*

Experimenting with lasers is very dangerous.

Experimenting with lasers you must observe safety rules.

1. Studying industrial gases ...
2. Playing volleyball with robots ...
3. Discovering new worlds ...
4. Converting the energy of wind into electricity ...
5. Travelling at the speed of light ...
6. Applying laser technologies ...

## Language Practice

### Vocabulary

#### I. Match the words with their definitions.

- |                 |                                   |
|-----------------|-----------------------------------|
| 1. laser, n     | a) to send out heat, light, sound |
| 2. behaviour, n | b) in only one colour             |
| 3. cavity, n    | c) the larger number or amount    |

**V. These sentences have a different structure but the same meaning. Change the structure of the sentences below so as to keep their meanings.**

EXAMPLE: *To make a hologram is rather difficult. Making a hologram is rather difficult.*

1. To produce a powerful beam of light is possible with the help of a laser.
2. To recognize a problem is the first step to its solution.
3. To establish relationship between natural phenomena is a major task of his theory.
4. To introduce the invention into practice sometimes requires more effort than making it.
5. To point out the mistakes to some people proves quite difficult.
6. To analyze the evidence correctly requires a lot of attention.

**VI. Shorten these sentences but do not change their meanings.**

EXAMPLE: *Having made a hologram we drew up a laboratory report. On (after) making a hologram we drew up a laboratory report.*

1. Having recognized the problem the scientist tried to find its solution.
2. Having changed the light spectrum we received another hologram.
3. Having invented the laser man expanded his possibilities.
4. Having studied the specific features of a new laser we put it into operation.
5. Having considered all the factors the engineers changed the whole system.
6. Having applied the laser at the works we increased the production dramatically.

**VII. What is the difference between these things? Ask your partner for explanations.**

EXAMPLE: *the boiling point / boiling water*

*A: - Peter, could you tell me what the boiling point is? B: - Sure. It's the temperature at which the liquid boils. A: - And what is boiling water? B: - Oh, It's quite simple. It's the water that boils.*

1. building block / building crane
2. melting point / melting metal
3. driving licence / driving man

4. cooling system / cooling surface
5. reading material / reading students
6. working conditions / working device

**VIII. Restore the original sentences.**

1. without being helped, the laser, won't succeed, in testing, he
2. a laser, in making, should use, you, a hologram
3. man, having invented, is capable of, the laser, light shows, successfully, producing
4. became possible, after the appearance, making holograms, in the 1960s, of a laser
5. all his knowledge and experience, applied, this work, doing, he
6. will provide, applying, another solution, the new device, to the problem

**IX. Translate the sentences into English using your active vocabulary.**

1. Имея разные уровни энергии, электроны нижних уровней могут переходить на более высокие путем поглощения света или тепла.
2. Без использования лазера голограмма невозможна.
3. Используя новый метод, они изменили спектр света.
4. Получение мощного луча возможно только с помощью лазера.
5. Проводя эксперименты с лазером, профессор объяснял студентам принцип его работы.
6. Выполнение этой работы требует опыта.
7. Учет отдельных компонентов изменит всю систему.
8. Что такое 'melting substance'? - Это вещество, которое плавится. А 'melting point' - это точка плавления.

## Reading and Speaking

**I. Practise reading these words.**

coherence [ksu'hiarsns]

wavelength ['weivlerjB]

characteristic [,ka3nkt3'nstik]

**II. Lasers appeared not long ago but we find it immensely difficult to imagine our life without them. What do you know about the history of lasers? When did they appear? Who constructed the first-known laser? What materials produce laser action? Scan the text to get the answers to these questions.**

### III. Study the text for more detailed information about lasers.

#### The Past and the Future of the Laser

A laser is a source of light but unlike anything that had ever been seen before 1960 when Theodore H. Maiman of Hughes Aircraft placed a specially prepared synthetic ruby rod inside a powerful flash lamp similar to the type used for high-speed photography. Activating the flash lamp produced an intense pulse of red light, which possessed the unique properties of monochromaticity (the light is of the same wavelength or colour), coherence (all the waves move precisely in step), and directionality (the beam can be easily manipulated). These features account for the enormous difference between the output of a laser and that of an incandescent light bulb.

With Maiman's invention the laser age was born. Everybody became interested in exploring this promising area of science. Within a very short time, numerous solid-state materials, gases, liquids, and semiconductor crystals were found possessing laser qualities. Almost every imaginable material was tried in order to produce new and interesting lasers. Even some varieties of jelly brand dessert were announced emitting xenon light, and according to this legend, they are supposed to work fairly well.

In many ways, the laser was a solution looking for a problem. Well, the problems soon followed in great numbers. It would be hard to imagine the modern world without lasers. They are used in everything from CD players to laser printers, fibre-optics and free-space communications, industrial cutting and welding, medical and surgical treatment, holography and light shows, basic scientific investigations in dozens of fields, including Star Wars weapons research. The unique characteristics of laser light make these and numerous other applications possible. In fact, it is safe to say that the vast majority of laser applications have not yet even been suggested.

However, if treated inadequately, an extremely powerful beam of laser light can be a source of destruction. You must never stand in the way of the cutting laser beam. Only by looking directly into the beam or its reflection from a shiny object you can damage your eyes. Besides, laser power supply being typically 2500 V or more, a QUALIFIED person must provide external power supply, as ordinary insulation is not enough. Thus, no matter how advantageous and useful they are, lasers *are* dangerous. Hence, safety rules must be strictly observed.

### IV. Provide detailed answers to these questions.

1. What is a laser? What other sources of light do you know?
2. What was the first laser like?
3. Does the laser possess any unusual properties? What are they?
4. When did the laser age begin?
5. Many substances produce laser light, don't they?
6. Were there any surprising discoveries?
7. Why is it difficult to imagine our life without lasers?
8. What are the most common uses of lasers?
9. Why are lasers considered dangerous?

### V. Explain what the author means by the following statements.

1. A laser is a source of light but unlike anything that had ever been seen before 1960.
2. With this invention the laser age was born.
3. According to this legend, they are supposed to work fairly well.
4. In many ways, the laser was a solution looking for a problem.
5. In fact, it is safe to say that the vast majority of laser applications have not yet even been suggested.
6. If treated inadequately, an extremely powerful beam of laser light can be a source of destruction.

### VI. Complete the gaps with suitable words from the box.

wavelength	destruction	applications	safety
liquids	intense	powerful	features
coherence	semiconductor		

A laser is a source of monochromatic, directional and coherent light. Monochromaticity means light of the same ... or colour. Light waves travelling precisely in step explain the property of ... . Besides, the laser beam can be easily manipulated. These unusual ... make laser light unique. The first laser consisted of a specially prepared synthetic ruby rod and a ... flash lamp. During the experiment the researcher observed an ... pulse of red light. Later solid-state materials, gases, ... and ... crystals were recorded having laser qualities. Lasers are considered to be a multibillion-dollar industry having numerous ... such as cutting and welding. However, lasers can be the source of both construction and .... That is why ... rules must be strictly observed.

VII. You have visited a very interesting exhibition on the applications of lasers. Your friend could not go with you and now he is interested in everything you saw or heard. Share your impressions with him and persuade him to visit this exhibition.

You can start like this: - Hello, Peter. I hear you have visited a laser exhibition. Is that true?  
- Certainly! And I must say it was worth visiting. ...

VIII. What information have you received from your friend? Would you like to visit this exhibition? What do you expect to see there?

## Further Reading

I. Practise reading these words.

oscillator [os'leit3]                      behaviour [bi'heivja]  
excited [ik'saitid]                      via [vaia]  
spontaneous [spDn'temjas]

II. Match the English words and expressions with their Russian equivalents.

- |                         |   |
|-------------------------|---|
| 1. light amplification  | a) усилитель                                      |
| 2. spontaneous emission | b) вынужденное излучение                          |
| 3. stimulated emission  | c) излучение; радиация; испускание                |
| 4. radiation            | d) спонтанное излучение                           |
| 5. oscillator           | e) усиление света                                 |
| 6. amplifier            | f) возбужденная частица                           |
| 7. ground state         | g) генератор                                      |
| 8. population inversion | h) высший энергетический уровень                  |
| 9. excited particle     | i) основное (квантовое) состояние                 |
| 10. upper energy level  | j) инверсия заселённости (энергетических уровней) |

III. Do you remember what the word 'laser' means? Read the text and learn how lasers work.

### How Lasers Work

The word 'laser' is an acronym standing for light amplification by stimulated emission of radiation. This is not exactly so since most lasers are actually oscillators (generators or sources of light) and not

amplifiers (devices for increasing the strength of a signal), though such lasers are also possible and used for some applications. However, nearly all lasers have the following in common:

A lasing medium. This can be a solid, liquid, gas, or semiconductor material, which can be pumped to a higher energy state.

A means of pumping energy into the lasing medium can be: optical, electrical, mechanical, chemical, etc.

A resonator consisting of a cavity with a pair of mirrors (flat or concave), one at each end of the laser for making stimulated light bounce back and forth through the lasing medium. One of the mirrors is totally reflective, the other being partially transparent to allow the laser beam to escape.

Lasers are based on a simple principle of atomic behaviour. Normally, nearly all atoms, ions, or molecules (depending on the particular laser) of the lasing medium are at their lowest energy level or 'ground state' (1). To produce laser action, the energy-pumping device must achieve population inversion through driving the majority of

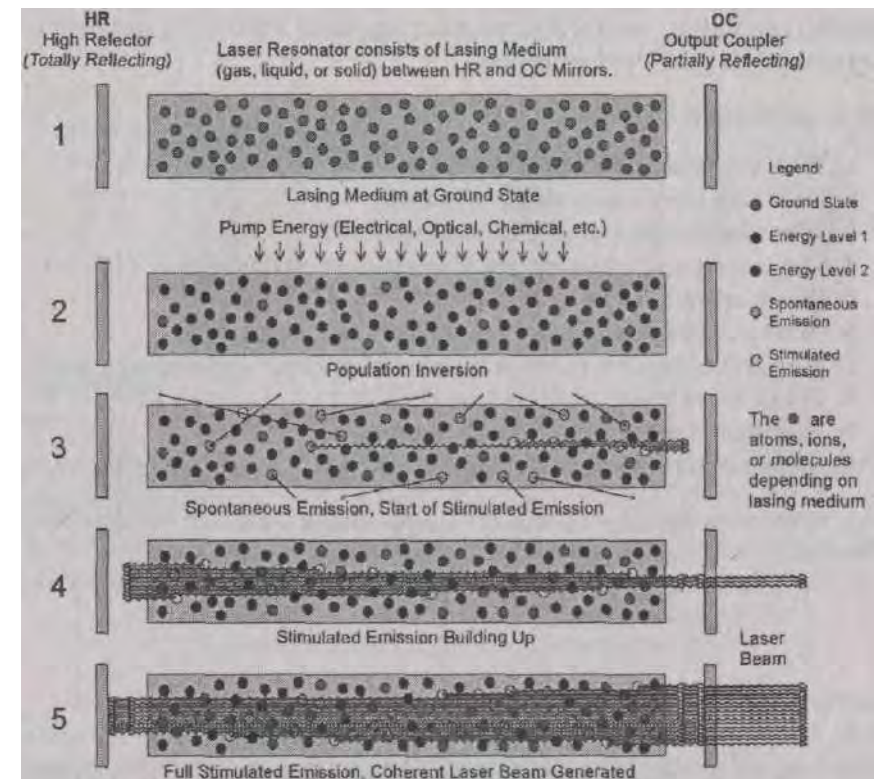

Basic Laser Operation

particles to the upper energy level (2). Sometimes dropping to the 'ground state' the excited particle emits a single photon of light. This is called 'spontaneous emission', not exactly useful, although causing the glow of a neon sign or the phosphor coating of a fluorescent lamp (3). Yet Einstein showed that a photon emitted nearly parallel to the direction of the resonator (3,4) will bounce back and forth many times stimulating excited particles along the way to lose the photons possessing three exactly the same qualities: wavelength, phase and direction. The tendency progresses resulting in the photons flow increasing via this 'stimulated emission' process (5). The resulting beam can be pulsed or continuous; visible, infrared or ultraviolet; less than a milliwatt - or millions of watts of power. It has the unique properties of being highly monochromatic, coherent and easily manipulated - something impossible with more common light sources. There you have it! Everything else is just details.

**IV. Explain the meaning of these words and expressions.**

laser, oscillator, amplifier, photon, 'ground state', 'spontaneous emission', 'stimulated emission'

**V. Give detailed answers to these questions.**

1. Why is the acronym 'laser' not very exact?
2. Do lasers have a common structure?
3. What lies in the basis of laser operation?
4. The lasing medium consists of various particles, doesn't it?
5. What are the stages of emission?
6. In what condition are the particles found normally?
7. Why is it necessary to move the particles to the upper energy level?
8. When do excited particles lose photons?
9. How does the massive flow of photons begin?
10. What is the output of the laser?

**VI. What does the laser consist of? Complete the table with the data from the text.**

<i>Laser Part</i>	<i>Function</i>
...	...

**VII. You are at the Great Laser Show with your friends. One of them gets interested in how lasers work. What basic information will you give him?**

## Activity

**I. Your friend is not attentive at the lesson and has understood nothing about lasers. At the end of the lesson the teacher suddenly gives a test. Your friend has some questions about laser structure and operation. Help him to pass the test.**

**II. Discussion. Lasers are certainly part of our life. However, like many other things they are not perfect. What are advantages and disadvantages of lasers? Do you think all laser technologies should be developed? What are the potential dangers of lasers?**

**III. Solve the crossword.**

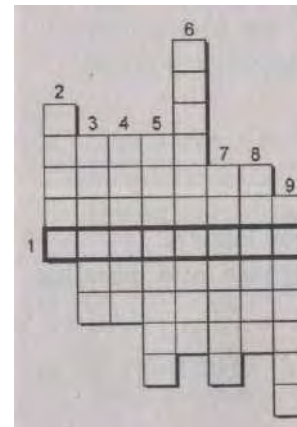

**Across:**

1. it is measured with the help of a laser

*Down:*

2. substances can be gassy, liquid and ...

3. part of a resonator

4. if the supply of energy is not maintained, the laser beam becomes ...

5. an atom / ion / molecule

6. a generator or a source of light

7. opposite to 'flat'

8. it is necessary to ... a particle in order to make it lose a photon

9. the function of a mirror is to ... objects

## Writing

**I. Write two paragraphs, one about advantages, the other about possible dangers of lasers.**

**II. Translate the following passage into Russian. Use the dictionary if necessary.**

### Lasers in Art and Entertainment

Lasers make impressive visual effects possible. In light shows it is common to use lasers emitting few laser wavelengths. Prisms are used for separating each colour. This results in producing many laser beams of different colours. The application of small vibrating

mirrors controlled by a computer provides the possibility of moving each



laser beam very rapidly thus creating moving coloured images. Since our vision is based on seeing the image a little time after it has disappeared, we are capable of observing a full picture created by a laser beam in spite of its being illuminated in each point for a very brief period of time. The first devices were used for making two-dimensional moving pictures on screens, but the latest developments are designed with the view of producing three-dimensional moving sculptures in free space - an impossible task to be performed by other means. Without the laser, the unique three-dimensional imaging properties of holography would not exist.

## Section B. Industrial Gases

### Lead-in

#### I. Discuss the following questions.

- How do we depend on gases? What gases do you know?
- What is air pollution? What are the causes and possible consequences of air pollution?

#### II. Listen to the conversation and say what you have learnt about the industrial gases.

*Teacher:* Pavel! Where are Nick and Olga?

*Pavel:* I'm afraid they are late.

*Teacher:* I insist on both of them coming on time. We can't work like this.

*Pavel:* And what are we going to do today, I wonder?

*Teacher:* We'll speak about some industrial gases and their properties.

*Pavel:* And what are industrial gases?

*Teacher:* Well, these gases are used in industry in making various products.

*Pavel:* Are these gases natural?

*Teacher:* Well, some of them, such as oxygen, nitrogen etc. are found in free state in the air. Others are man-made, like freon, which is used in welding.

*Pavel:* I suppose they have a very wide range of applications.

*Teacher:* You are quite right. The importance of using them can hardly be overestimated. However, gases are not only part of the industrial process. They also pollute the environment. Do you know what problems air pollution causes?

*Pavel:* Certainly. I've heard a lot about acid rains, the greenhouse effect, the ozone layer depletion.

*Teacher:* Very good. Well, Nick, here you are at last.

*Nick:* Sorry for being late, sir.

#### III. Complete the dialogues.

- Olga, ...?
  - It's past 12, sir. I'm sorry for ...
  - It's OK, but I insist on ...
  - ...
- ..., I'd like to know?
  - First, I'm going to tell you ...
  - It sounds interesting. Are they used for ....?
  - ...
- Do industrial gases pollute the environment?
  - ...
  - What problems ...?
  - Well, the hottest problems are ...

#### IV. Match a line in A with a line in B.

##### A

- I'm sorry for being late.
- I insist on your coming on time.
- Scientists object to chloro-fluorocarbons being used in industry.
- Where is helium used?
- Are all pollutants man-made?
- How does the excess of nitrogen in the air influence the ecosystems?

##### B

- It results in destructing the biological balance of the soils and water (eutrophication).
- They have serious reasons.
- I hear of natural pollutants being sent into the atmosphere for billions of years.
- Sorry, sir.
- In arc welding.
- It's OK.

## Language Practice

### Vocabulary

#### I. Match the words with the opposite meaning.

the same	to clean
natural	non-flammable
colourful	man-made
flammable	abundant
toxic	dioxide
to pollute	non-toxic
monoxide	colourless
rare	different

#### II. Make all possible word combinations.

industrial	rain
natural	effect
solar	gases
combustible	state
air	radiation
fossil	pollution
acid	pollutants
greenhouse	fuels

#### III. Find in each line the derivative from the first word.

- perform - performance, form, super, robot
- exact - object, extra, exactly, react
- object - inject, subject, objection, substance
- danger - development, average, discovery, dangerous
- experience - science, experiment, inexperience, excess
- pollute - populated, pollutant, depletion, protective
- measure - metallurgy, absorption, measurement, damage

### Grammar: Gerundial Constructions

#### IV. Join two sentences into one. Pay attention to the use of prepositions.

EXAMPLE: *Nitrogen is used in metal industry. We know that.*

We know of nitrogen being used in metal industry.

- Silver and copper are very good conductors of electricity. We are aware of that.
- Freon destructs the ozone layer. We are afraid of that.
- Robots will replace men. The idea of that goes back to ancient times.
- Alice is making that hologram without any help. I was surprised at that.
- The students should study the properties of carbon. The professor insists on that.
- Radioactive carbon should be used to date ancient things. The scientists recommend that.

#### V. Rephrase the following questions and let your friend answer them. Use the prepositions where necessary.

EXAMPLE: *Do you mind if I use your computer?*

- Do you mind my using your computer?
- No, I don't. You can use it whenever you want.

- Would you mind if they create an intelligent robot?
- Do you mind if I make a report on air pollution?
- Do you insist that we should sign the Clean Air Act? (on)
- Will they object if I use the laser without asking for their permission? (to)
- Do you believe that we will restore the ecological balance on the planet? (in)
- Are you sorry that you are late? (for)

#### VI. Open the brackets and use the gerund in the Active or Passive Voice.

- Nobody is surprised at his (to receive) the Nobel prize for his discoveries in optics.
- We are interested in new technologies (to develop).
- Environmentalists insist on our (to cut) releases of CO<sub>2</sub> into the atmosphere.
- We hear of gases (to apply) to produce the flame temperature of 6,000 °F.
- I object to acetylene (to mix) with air in the workshop.
- We are against transport (to pollute) the atmosphere.
- The inventor made a report on the laser (to use) in surgery.

#### VII. Restore the original sentences.

- being cheap, the air, used, is, because of, in welding
- steel, oxygen, being used, we know of, in making

3. has the merit of, the device, being reasonably up-to-date
4. does not mind, the student, being helped
5. our, objects to, the professor, carrying out the experiment
6. aircraft, is capable, lifting, helium, of

**VIII. Correct mistakes in the following sentences.**

1. Do you believe in life exist on other planets?
2. Would you mind my lating?
3. We insist their buying this robot.
4. He spoke about distant galaxies be observed through a telescope.
5. They are interested in materials producing without losses of energy.
6. If you do not observe the readings, you will result in the device being break.
7. I don't mind be helped if you do not mind helping me.

**IX. Translate the following sentences paying attention to different forms of the gerund.**

1. I require thermal power stations being closed because of their damaging the environment.
2. We hear of biosilk having been invented.
3. Newspapers report of acid rains having destroyed life in several Swiss lakes.
4. Global warming will cause polar ice melting.
5. It is difficult to imagine robots having explored ocean depths autonomously.
6. I know of toxic gases having been used during the last experiment.
7. I am sure of having read this article earlier.
8. Safety rules insist on acetylene being stored in the liquid state under pressure.

**X. Translate the sentences into English using your active vocabulary.**

1. Он не возражает против того, чтобы роботы выполняли эту опасную работу.
2. Мы знали, что воздух используется в металлургии.
3. Крупные фирмы настаивают на том, чтобы роботы заменили человека.
4. У студентов возникли трудности при определении свойств фреона.
5. Он отвечает за то, чтобы работа была закончена своевременно.
6. Вы можете рассчитывать на то, что он дает вам точную информацию.
7. Он жаловался на то, что я очень медленно работаю.
8. То, что он составил программу так быстро, было приятным сюрпризом.

## Reading and Speaking

**I. Practice reading these words.**

nitrogen ['naitridʒn]                      dioxide [dai'dksaid]  
 ultraviolet ['Altra'vaislit]              chlorine ['klo:ri:n]

**II. Our manufacturing industry strongly depends on gases. Look through the text and enumerate the industrial gases, mentioned there.**

**III. Read the text attentively for more information about industrial gases.**

### Industrial Gases

We know of many gases used in industry for making various products. They are called industrial gases. Some of them are man-made and some are found in their natural state. Let us consider the most important ones.

Colourless, odourless, tasteless, non-toxic, and non-flammable, nitrogen has many uses, including glass making, food conserving, preventing semiconductors from oxidation.

Oxygen is the second largest volume industrial gas used in producing steel, building bridges and making electric equipment.

Being the most abundant element (98%) in the universe hydrogen has almost as many industrial uses as nitrogen and oxygen. It is needed in metal industry, in food industry for preparing margarine and in oil processing. Also, power stations depend on hydrogen cooling their high-speed turbine generators.

Can you imagine your life without eating ice-cream, spraying deodorants, drinking sodas, and fire fighting devices? All these things are possible due to carbon dioxide.

Some people believe that balloon flying is for children. Still, helium is a serious gas capable of rays detecting and aircraft lifting. It is also used in arc welding.

It is impossible to imagine present-day life without air conditioning, refrigerators, spraying aerosols, and packaging foam for the TV or VCR. However, freon, necessary for making these common things, is found depleting the ozone layer, which protects us from

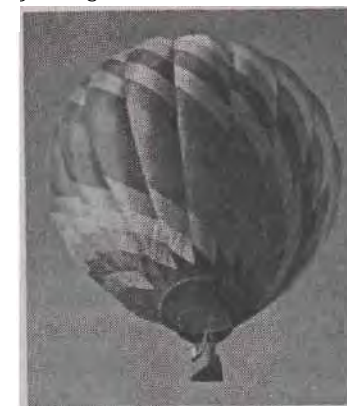

the destructive solar ultraviolet radiation. That is why scientists all over the world insist on fluorocarbon refrigerants being banned.

Argon is a noble gas comprising 0.98% of the atmosphere and forming no-known chemical compounds. Colourless, odourless, tasteless and non-toxic, argon is mainly used in producing high-quality welding in stainless steel and aluminum industry. Chlorine gas is very toxic; nevertheless it protects us from falling ill by purifying drinking and swimming water. It also takes part in making many chemicals, including solvents, plastics, rubbers and pesticides.

Water-based paints and vinyl records are made with the help of acetylene, which has many other applications. Stored in a liquid state it is also used as a fuel producing a large amount of heat and the highest flame temperature (about 6,000F, or 3,300°C) of any known mixture of combustible gases. When burnt with the correct amount of air, acetylene gives a pure white light. For this reason it was once used for illuminating places where electric power was not available. The air itself is used as an industrial gas. It acts as a protective envelope for metals during the welding process because it does not react chemically with these metals or other elements.

**IV. Try to complete the table without looking into the text. Compare your table with that of your partner.**

<i>Gas</i>	<i>Properties</i>	<i>Application</i>
...	...	...

**V. Complete the sentences with suitable words from the box.**

rubbers	foam	acetylene	toxic
helium	dioxide	man-made	noble
non-flammable	air	oxygen	odourless

Gases used in industry for making all kinds of products are known as industrial gases. They can be classified as natural and ... . The examples of natural gases are nitrogen, ..., and hydrogen. The first largest industrial gas is nitrogen. It is colourless, tasteless, ..., ... and non-toxic. Breathing and combustion are impossible without oxygen. Hydrogen is the most abundant gas in the universe. Carbon ... is used in producing lemonades and conserving food. Balloons are normally filled with ... , The gases depleting the ozone layer are

known as fluorocarbons. They are necessary in air conditioning, refrigeration and making packaging .... Argon is a ... gas applied in welding. Chemicals, such as solvents .... plastics, and pesticides are available due to chlorine, which is a very ... gas. Water-based paints and vinyl records are made with the help of ... that is also known for producing an extremely hot flame. Even the ... is used as an industrial gas because it will not react chemically with any elements.

**VI. Devise a questionnaire on the topic "Industrial Gases". See if your friend can answer all the questions.**

**VII. What data does the text provide? Have you learnt any new things? Do you think the use of fluorocarbons should be reduced? Is it possible to reduce it?**

## Further Reading

**I. Practise reading these words.**

volcanoes [vɒl'keɪnsuz]

eutrophication ['ju:trɒfɪ'keɪʃən]

consequence ['kɒnsɪkwəns]

depletion [dɪ'pli:kʃən]

**II. These words are taken from the text. Use the dictionary to find out their meanings.**

ash, n

stir, v

rot, v

blanket, v

far-reaching, adj

soil, n

vegetation, n

chlorofluorocarbons, n

face, v

prospect, n

**III. Discuss the following questions with your partner.**

1. Why is air pollution considered a global problem today?
2. What are the consequences of air pollution?
3. Is it possible to minimize the bad consequences of air pollution? If so, how?
4. Are all air pollutants man-made? Give examples.
5. Is there a problem of air pollution in your country?

**IV. Gases are not only a component of the industrial process. They are also its result. Unfortunately they often produce a damaging effect on the environment. Read the text attentively to learn more about air pollution.**

## Air Pollution as the Major Problem of the Day

Since the 19th century we are getting increasingly worried about industry polluting breathing air in densely populated cities where the great majority of people live.

Not all air pollutants are man-made. For billions of years the air has been polluted by volcanoes throwing out tons of ash and smoke, dust stirred by the wind, gases given off by growing plants or by rotting animal and vegetable matter, salt particles from the oceans, etc. However, having discovered fire man added much to natural pollutants by burning fossil fuels. Sherlock Holmes for example, observed London "pea-soupers", blanketing the city for days. That's because Londoners used soft coal for heating their houses.

Let us review what we know about combustion. All fossil fuels naturally contain hydrogen, carbon and sulphur, present in plants and animals. Uniting with oxygen during combustion these gases result in forming water and releasing carbon monoxide, carbon dioxide and sulphur dioxide. Besides, oxides of nitrogen are produced in the air whenever there are high temperatures, *be it*<sup>2</sup> a car spark or a lightning stroke. These natural processes have far-reaching consequences.

The oxides reacting with water in the air produce carbonic, nitric, nitrous, sulphurous and sulphuric acids. Acid rains have damaging effects on materials and the environment. An excess of nitrogen in the air, greater than the ecosystems are able to absorb results in destructing the biological balance of the soils and water (eutrophication). In the layers of the air close to the ground photochemical (photo-oxidizing) pollution causes the formation of 'bad ozone', called so because of its destructing effect on human health and vegetation. And vice versa, the 'good ozone' protecting us from solar ultraviolet (UV) radiation in the stratosphere is being depleted by NO (mainly from traffic) and by chlorofluorocarbons. The ozone layer depletion has damaging effects on human health and environment. The greenhouse effect consists in atmospheric gases (CO<sub>2</sub>,



CH<sub>4</sub>, O<sub>3</sub>, N<sub>2</sub>O, CFCs) absorbing infrared (IR) radiation, reflected from the surface of the earth. When not reflected back into space the energy is absorbed and transformed into heat. Without the natural greenhouse effect the average temperature on the earth *would be*<sup>3</sup> -18°C. **However**, since the industrial revolution,

the concentration of greenhouse gases proves increasing. Thus, today we are facing the prospect of global warming with all its unpleasant consequences.

<sup>1</sup> лондонские желтые туманы, <sup>2</sup> будь то, <sup>3</sup> была бы.

**V. Say if the following statements are true or false. Correct the false statements.**

1. Everybody is concerned with air pollution today.
2. Large cities seem to be the most highly polluted places.
3. All air pollution is due to man's activities.
4. A 'pea-souper' is the name for a person who is fond of eating pea soups.
5. Smog means *smoke + fog*.
6. The process of oxidizing is known as combustion.
7. Combustion causes problems because of the oxygen released into the atmosphere.

**VI. What environmental problems does air pollution cause? Fill in the table.**

Problem	Pollutants	Cause	Consequences
...	...	...	...

**VII. Complete these sentences with suitable words from the box.**

1) rubbers	4) foam	7) acetylene	10) toxic
2) helium	5) dioxide	8) man-made	11) noble
3) non-flammable	6) air	9) oxygen	12) odourless

Gases used in industry for making all kinds of products are known as industrial gases. They can be classified as natural and ... . The examples of natural gases are nitrogen, ..., and hydrogen. The first largest industrial gas is nitrogen. It is colourless, tasteless, ... and non-toxic. Breathing and combustion are impossible without oxygen. Hydrogen is the most abundant gas in the universe. Carbon ... is used in producing lemonades and conserving food. Balloons are normally filled with ... . The gases depleting the ozone layer are known as fluorocarbons. They are necessary in air conditioning, refrigeration and making packaging ... . Argon is a ... gas applied in welding.

Chemicals such as solvents, ..., plastics, and pesticides are available due to chlorine, which is a very ... gas. Water based paints and vinyl records are made with the help of ... that is also known for producing an extremely hot flame. Even the ... is used as an industrial gas because it will not react chemically with any elements.

**VIII. You are taking part in the conference on the environmental problems. Deliver a report on air pollution.**

## Activity

**I. 'Friends of the Earth' have organized a summer camp for everybody interested in the environmental protection. The hot issue of the day is air pollution.**

*Student A:* The air in your city is getting more and more polluted. You want to write an article on air pollution problems. Interview a member of the "Friends of the Earth" organization for more information about air pollution and its effect on the environment.

*Student B:* You possess up-to-date and interesting information on environmental problems and their solutions. Share your knowledge at the interview.

**II. Discussion.** The consequences of air pollution may be fatal that is why we must take measures before it is too late. Can anything be done? What exactly? Read this information and do the task below.

Most of the classic atmospheric pollutants ( $\text{CO}_2$ , CO,  $\text{O}_3$ , lead and other particles), often found in the form of smog, are sadly known for affecting human health, ecosystems and buildings. Clean air laws are aimed at reducing air pollution.

Since the 1950s when the Clean Air Acts were introduced in Britain, we are sure of the atmosphere improving slowly. Local authorities insist on companies receiving integrated pollution licenses reducing the amount of gases they release. These licenses are strictly controlled to avoid limits being exceeded. Special detectors are placed around the factories with the purpose of monitoring the amount of oxides sent to the atmosphere...

**In groups, analyze the condition of air in your city/country. Is it satisfactory? Work out several Clean Air Laws for improving the situation. Report on the problem and offer your suggestions.**

## III. Solve the crossword.

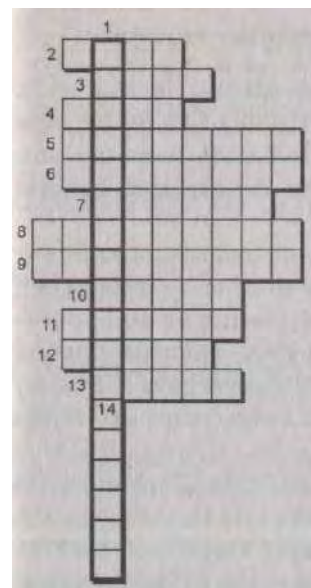

### Down:

1. CFC (man-made chemical, that is used in sprays, fridges, air-cooling systems; it destroys the ozone layer)  
14. a chemical element; diamonds and coal are made of it

### Across:

2.  $\text{H}_2\text{SO}_4$ ,  $\text{HNO}_3$ , ...  
3. People burn coal to ... their homes.  
4. not quick  
5. science, studying robots  
6. copper has a valuable ... of corrosion resistance  
7. to disagree, be against sth  
8. uneasy  
9. substance that pollutes the environment  
10. to bring together  
11. up-to-date  
12. a noble industrial gas  
13. a compound of oxygen and another chemical element

## Writing

**I. The Government is going to build a thermal power station in your district. This power station will burn waste to produce electricity. Send them a letter expressing your carefully considered and reasoned objection to the project.**

You may begin like this:

Dear Prime Minister,

We are addressing you on the subject of a thermal waste-to-energy power station being designed in our district.

We believe that this project has certain advantages but they are outnumbered by disadvantages...

...

We will appreciate your prompt response.

Sincerely yours,  
Friends of the Earth

II. Translate the following passage into Russian. Use the dictionary if necessary.

### The Ozone Layer Depletion

Ozone (a molecule having three oxygen atoms) is the main component in the upper atmosphere at the altitude of 19-30 km. We depend on this 'good ozone' absorbing UV radiation from the sun thus protecting us from the risks of skin cancer and genetic mutations.

An abnormal lowering in concentrations of ozone at the South Pole was discovered in 1980. At the end of the southern winter, when the sun returns, the ozone content is found depleting by 40 to 60%. Traffic releasing NO, oceans emitting methylene chloride causing the chlorine build-up, man producing chlorofluorocarbons (CFCs) by his daily activities result in creating 'ozone holes,' that affect the climate and biological systems.

The scientists believe in mending the ozone holes. They object to releasing CFCs and other ozone-depleting gases into the atmosphere, the restrictions of the Montreal Protocol helping to achieve this aim. However, even after introducing a complete ban, it will be 50 years or more before pollutants levels reduce to their pre-ozone hole values.

# Unit Eighteen

## SCIENTIFIC EXPLORATION

---

### *Section A. Optical devices*

#### Lead-in

##### **I. Discuss the following questions.**

- How do scientists explore micro- and macroworlds?
- What means of scientific exploration do you know?
- Do you believe we can contact alien civilizations? How?

##### **II. Listen to the students' conversation and learn about an unusual application of the laser telescope.**

*Peter:* Pavel, have you heard about artificial stars?

*Pavel:* Not yet, but I'd like to know about them more, anyway.

*Peter:* Well, this article says they are created with the help of a laser telescope. One of these experiments is described here.

*Pavel:* Really? And what was the result of the experiment?

*Peter:* The reporter claimed that a bright sodium star, as big as about a natural star, had been generated.

*Pavel:* That sounds fascinating! How was the experiment carried out?

*Peter:* Oh, it was said in the article that the Solar Vacuum Tower Telescope had launched a 4-watt laser beam to the atmosphere and recorded the return light from the generated artificial star at the same time.

*Pavel:* Why do you think this artificial star has been created?

*Peter:* Well, there may be other reasons but I'm sure the star will serve as a model for further research of the universe.

*Pavel:* Oh really? May be in this way we'll be able to establish interstellar communication?

*Peter:* That's a good idea, but the scientists will have to carry out a number of experiments to prove that.

### III. Complete the dialogue.

- How are artificial stars ...?
- As far as I know, a laser telescope is ....
- And ... about any successful ...?
- Yes, yesterday I found out...
- ... interesting. ... carried out?
- ...
- I wonder why ...
- Well...
- Do you suppose ...?
- ...

### IV. Match a line in A with a line in B.

#### A

1. Would you like to know more about artificial stars?
2. What are the means of scientific exploration?
3. What does the article deal with?
4. What did the reporter claim?
5. The scientists hope they'll contact distant civilizations with the help of a laser.
6. Why did scientists look for radio signals from aliens?

#### B

- a) An unusual application of a laser telescope.
- b) They believed radio waves were the most energy-efficient way of sending signals across the space.
- c) A telescope and a microscope, for example.
- d) Of course, I would!
- e) He maintained that an artificial sodium star had been generated.
- f) That sounds fascinating!

## Language Practice

### Vocabulary

#### I. Find in B the English equivalents to the Russian words in A.

##### A

1. рассматривать
2. длиться
3. весь, целый
4. удаленный
5. глазок
6. увеличивать
7. множество
8. постоянный

##### B

- |              |                |                 |
|--------------|----------------|-----------------|
| a) to scan   | b) to look for | c) to detect    |
| a) to search | b) continuous  | c) to last      |
| a) to limit  | b) entire      | c) efficiently  |
| a) distant   | b) currently   | c) present      |
| a) lens      | b) detector    | c) eyepiece     |
| a) to modify | b) to magnify  | c) multiply     |
| a) variety   | b) practicable | c) modification |
| a) single    | b) similar     | c) permanent    |

### II. Make up all possible word combinations.

laser	signals
radio	telescope
alien	intelligence
artificial	star
interstellar	communication
ultraviolet	microscope

### III. Find in each line the derivative from the first word.

1. record - accordingly, dimension, recorder, reward
2. modify - model, method, melting, modification
3. suggest - suggestion, supposition, substance, researcher
4. achieve - intelligent, achievement, reflection, reach
5. part - multitude, precise, partial, compound
6. change - charge, chain, suggestion, exchange
7. apply - amplify, allowance, empty, application
8. signify - sign, single, insignificant, similarity

## Grammar: Reported Statements

### IV. What opinion did these people express?

EXAMPLE: *Laser operation is based on a simple behaviour of atoms.*  
*I knew it.*  
I knew that laser operation was based on a simple behaviour of atoms.

1. Optical devices are hardly used in the scientific research. They announced it.
2. The Sun moves around the Earth. People believed it.
3. The microscope is used for observing stars. He said so.
4. Robots do not possess intelligence. I was sure.
5. Materials engineers do not synthesize new materials. She supposed it.
6. Any scientific research takes a lot of time and patience. The engineer thought so.

### V. The researchers reported about an important experiment. What did they say? Use the verbs *to say, to report, to announce, to state, to point out, to claim*.

EXAMPLE: *The research was carried out successfully. (to announce) They announced that the research had been carried out successfully.*



1. We studied the possibilities of laser communication.
2. Miniature multifunction telescopes were developed for scientific observations.
3. The instruments were adapted to imaging and communication applications on Earth.
4. The multi-function telescope served three purposes: space navigation, communication and infrared spectrometry.
5. A prototype device was built and tested to demonstrate two of these functions.
6. The prototype instrument was assembled mostly from commercially available parts.

**VI. Explain the difference between these sentences.**

1. a) He said that the object was badly illuminated.  
b) He said that the object had been badly illuminated during the experiment.
2. a) They noticed that the microscope was significantly modified.  
b) They noticed that the microscope had been modified to increase magnification.
3. a) The observers reported that they recorded laser signals by means of a telescope.  
b) The observers reported that they had recorded laser signals from the universe.

**VII. Say what the scientists predicted long ago.**

EXAMPLE: *Man will invent artificial intelligence. (to be certain)* The scientists were certain that man would invent artificial intelligence.

1. A super powerful microscope will produce images. (to be sure)
2. We will contact an alien civilization by means of a laser telescope. (to suggest)
3. Air pollution will cause the global warming of the climate. (to predict)
4. Energy will be obtained from alternative sources. (to assume)
5. Fascinating achievements will be made in the area of biotechnology. (to suppose)
6. Mars will be explored by completely autonomous robots. (to believe)

**VIII. Open the brackets and use the verb in the right form.**

1. We learnt that laser communication (to be) practicable in the near future.
2. The engineers were surprised to see that modified robot (to move) like a human.

3. She was sure that she (to find) the most energy-efficient way of sending signals soon.
4. He found out that properties of a substance (to depend) on its structure.
5. I was afraid that she (to damage) the microscope objective lens.
6. Peter told me that he (to see) the William Hershel Telescope in operation.

**IX. Correct mistakes.**

1. We thought that those parts are combined to form a microscope.
2. He realized that he spotted a distant planet.
3. I was told that he takes part in the research.
4. It was announced that engineers object to applying this technology.
5. He said that an artificial star was created with a laser telescope.
6. We supposed that the new approach will be more fruitful.
7. The investigators announced that they obtained a powerful microscope soon.

**X. Translate the sentences into Russian using your active vocabulary.**

1. Сообщалось, что ученые разработали телескоп, который будет внимательно следить за небом.
2. Раньше предполагали, что радиоволны являются самым эффективным способом передачи сигналов в межпланетном пространстве.
3. Некоторые ученые считали, что технически развитые цивилизации попробуют установить контакт с помощью лазера.
4. Руководитель проекта заявил, что его лаборатория уже провела около 20 000 наблюдений.
5. Исследователи были уверены, что сверхчувствительный микроскоп позволит им сделать важное открытие.
6. Он узнал, что существует огромное множество разнообразных оптических устройств.
7. Изобретатель доказал, что его модифицированный микроскоп значительно расширяет возможности исследований.

## Reading and Speaking

**I. Translate these compound nouns.**

alien intelligence	alien laser beam
energy-efficient	laser light
radio telescope	the Nobel prize winning scientist
pulsed laser beam	light year
laser pulse signal	interstellar laser communication

**II. Is there life on Mars? Look at the pictures and the headline. What can the article be about? Skim it quickly to check your guess. What does the first picture mean?**

**III. Read the article attentively and learn how scientists try to establish interstellar communication.**

### BBC News Online



A telescope designed to search for laser signals from alien intelligences is to start scanning the skies next year. The 1.8-metre (6 ft) Optical SETI (Search for Extra-Terrestrial Intelligence) Telescope is currently being built in Harvard.

For more than 40 years, scientists have looked for radio signals from aliens on the understanding that radio waves provide the most energy-efficient way to send a signal across interstellar distances. But despite using the world's largest radio telescopes with highly sensitive detectors, no sign of a signal has been found in space as yet.

Several years ago some astronomers said it was hardly surprising that no radio signal had been detected yet. They maintained that researchers might be looking for the wrong kind of message. It was assumed that a

technologically advanced race might be more likely to communicate using pulsed laser beams rather than radio. The new approach was hoped to be more fruitful.

Searching for laser pulse signals was first suggested by the Nobel prize winning scientist Charles Townes in 1961 and was, according to its supporters, met with 'more interest than enthusiasm'. It was thought that a high-powered laser coupled with a large telescope could send a signal across many light years of space. Scientists believed that an alien laser beam would be pulsed to encode a signal.

During the pulse, lasting perhaps less than a millionth of a second, the laser light could be much brighter than the light from the star in the system from which the signal is being

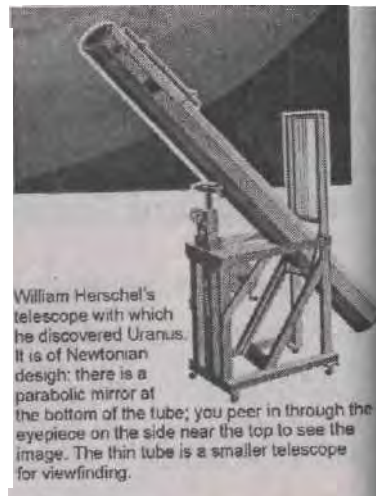

William Herschel's telescope with which he discovered Uranus. It is of Newtonian design: there is a parabolic mirror at the bottom of the tube; you peer in through the eyepiece on the side near the top to see the image. The thin tube is a smaller telescope for viewfinding.

sent. The new SETI Telescope will look for these brief pulses of laser light, scanning the entire northern sky once every 200 clear nights. It will have a special camera fitted with an array of 1,024 ultra-fast detectors that can spot flashes as short as a billionth of a second.

According to the researchers, using only the Earth 2001 technology we can now generate a beamed laser pulse that appears 5,000 times brighter than our Sun, as seen by a distant civilization. In other words, interstellar laser communication is altogether practicable with the new Optical SETI Telescope searching the sky for such signs of intelligent life elsewhere in the galaxy.

**IV. Say if the following statements are true or false. Correct the false statements.**

1. Scientists believe in the possibility of discovering alien intelligence with the help of a microscope.
2. The Harvard telescope has been designed specially for interstellar communication.
3. Radio waves are said to be efficient for sending signals across space.
4. Radio telescopes are reported to be out of date.
5. No alien life has been found as yet because the search is being done in the wrong direction.
6. The idea of looking for laser signals from space has proved inapplicable.
7. Aliens are supposed to decode their signals with a laser.
8. Laser light is much brighter than the light of a star.
9. The laser is equipped with sensitive ultraviolet detectors.

**V. Find in the article the information related to the following.**

- a) SETI (Search for Extra-Terrestrial Intelligence) project
- b) radio telescopes
- c) alien civilizations
- d) Charles Townes
- e) laser light
- f) northern sky
- g) detectors
- h) the Earth 2001 technology
- i) interstellar laser communication

**VI. Produce a radio programme on the problems of interstellar communication. Then make a report on this programme using Reported Speech.**

*The host of the programme:* introduce shortly the topic and the guest - an outstanding scientist taking part in the Seti Project.

*The guest:* describe the latest developments in the area of interstellar communication using year project.

*Listeners:* telephone to the studio and ask the guest questions.

**VII. Give the article another headline.**

---

## Further Reading

---

**I. Microscopy is a relatively young science but it uses a lot of words from 'old' languages - Latin and Greek. Find these words in the text.**

**II. Man is expanding the sphere of exploration not only outwards but inwards as well. Why are we so interested in the micro world? Look at the picture and the title of the text and say what the text is about.**

**III. Scan the text to find answers to these questions.**

1. What is microscopy?
2. When was the microscope invented?
3. How do microscopes differ?
4. What types of microscopes are mentioned in the text?

**IV. Read the text attentively for more information about microscopy.**

### Imaging Atoms

Observing and studying objects that range in size from millimeters to nanometers intrigues everyone. This fascinating science is called microscopy, currently applied to every field of science and technology from biology and chemistry to physics and engineering.

Many scientists today are working with single atoms or molecules. To do their work they have to be able to 'see' molecules and atoms in some way. Optical instruments used for producing a magnified image of a small object are known as microscopes. The first compound microscope containing an objective lens system and an eyepiece system was created by a Dutch spectacle-maker Zacharias Janssen in 1595. It



was simply a tube with lenses at each end. Having been modified and improved this microscope is most commonly used today giving us the possibility of viewing individual cells, even living ones, in two dimensions. Compound microscopes are

light illuminated. Their high magnification is achieved by passing light reflected from the object through a combination of magnifying lenses. Unfortunately the possibilities of light microscopes are limited by the resolution of the lenses being about 0.2 micrometer.

The resolving power can be significantly increased by using other types of microscopes. They come in a wide range of forms and use a multitude of illumination sources (light, electrons, ions, X-rays and mechanical probes) and signals to produce an image. An electron microscope, for instance, produces images by using electrons and electron lenses. A microscope similar to it in principle but using a beam of protons instead of electrons is known as a proton microscope. A device for viewing very small particles by observing the light from an intense beam scattered by them is called an ultraviolet microscope. The results of the observation are recorded with the help of a photo-micrograph - a photograph of the image obtained with the help of a microscope. This enables a permanent record to be kept and also enables ultraviolet radiation to be used for the illumination of the specimen. All modern powerful microscopes are combined with computers.

A microscope can be as simple as a handheld magnifying lens and as complex as a multimillion-dollar research instrument. Using these tools, a microscopist explores the relationship of structure and properties of a wide variety of materials in order to more fully understand the reasons why a particular item behaves the way it does.

**V. Say if the following statements are true or false. Correct the false statements.**

1. Microscopy studies measure units ranging from millimeters to nanometers.
2. Microscopy is not applied to mechanical engineering.
3. It is impossible to see an atom with a naked eye.
4. Modern microscopes do not have an objective lens system and an eyepiece system.
5. The first compound microscope was created in Holland in the 16th century.
6. Janssen's original microscope is widely applied today.
7. The light microscope has a high magnification but a low resolution.
8. The sample can be illuminated by light, electrons, ions, X-rays and mechanical probes.
9. The results of the observation are recorded with the help of a microphotograph.
10. A simple microscope is a multimillion-dollar research instrument.

**VI. Expand these sentences with the information from the text.**

1. Microscopy is fascinating.
2. Microscopy is useful.
3. The microscope is an instrument.
4. Zacharias Janssen was an inventor.
5. Microscopes vary.
6. A microacopist studies materials.

**VII. Several types of microscopes are mentioned in the text. What are they? Fill in the table with their description.**

<i>Microscope</i>	<i>Principle of Work</i>
...	...

**VIII. Is the title 'Imaging Atoms' appropriate for this text? Why? Give the text another title. Transform the text into an encyclopedic entry by shortening it to the maximum.**

---

## Activity

**I.** Your friend is crazy about microscopes and wants to become a materials engineer. You do not see what is so special about this profession. Ask your friend for information. Report to the class what you have found out. Start like this:

- Hello, Denis, what are you busy with?
- Oh, hi. I'm studying ...

**II.** The Science Museum in your city is going to open a new gallery - 'Optical Devices'.

**a)** You are experts in the field of optics, specializing in telescopes and/or microscopes. Design the gallery in groups. What items will be exhibited? Why? What information on these items will be supplied?

**b)** Act as a guide in the gallery and describe it to the class. Choose the best project.

**III. Solve the crossword**

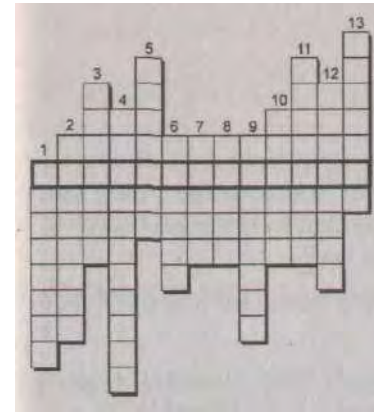

**Across:**

1. ...?

*Down:*

1. part of a modern microscope
2. to spot a distant planet the telescope must be very ...
3. an instrument for scanning
4. the place where a telescope is placed
5. not capable to increase or improve
6. opposite to 'encode'
7. a creature from another world
8. a sudden quick bright light
9. microscopes range from complex to...
10. the science studying light
11. part of a microscope or a telescope
12. an instrument for recording
13. opposite to 'near' or 'close'

---

## Writing

**I.** Write an article about interstellar communication for the newspaper column 'In Brief'.

**II.** Translate the following passage into Russian. Use the dictionary if necessary.

Do you know how telescopes work? Try this experiment and see for yourself.

In order to carry out this experiment take two magnifying lenses of different sizes. Hold the large lens at arm's length, and adjust the distance of the other from the eye so that a distant object, seen through both lenses, seems close. This shows the principle of the refracting telescope. The objective lens forms an inverted real image of the object looked at. The eye lens views the real image of the objective lens and shows it to the eye as an enlarged and inverted virtual image. A real image can be shown on a screen, e.g. a film is a series of real images. A virtual image cannot, e.g. reflection in a mirror. Most large telescopes are reflecting type mainly because lenses cannot be made as large as mirrors. The purpose of the large size of the mirror or objective lens is not to magnify, but to gather light. The larger it is the more light it gathers.

## Section B. Space Shuttles

### Lead-in

#### I. Discuss the following questions.

- How many events from the history of cosmonautics can you remember? Make a list and compare it with that of your partner.
- What is a space shuttle? What is it used for?

#### II. Listen to the conversation and say what you have learnt about space shuttles.

*Astronaut:* Shuttles are fascinating vehicles. They appeared only in the 1980s and have already become irreplaceable.

*Olga:* Are they different from spaceships?

*Astronaut:* Certainly! They are reliable, recoverable and therefore reusable and less expensive. The hundredth successful launch was in October 2000.

*Olga:* Could you tell us how shuttles work?

*Astronaut:* Of course. At the take-off the boosters and the orbiter's engines have to initially provide about 30 MN of thrust to lift a 2,000 tonne shuttle off.

*Olga:* This must be very hard on the crew.

*Astronaut:* Indeed, during the take-off the crew can experience forces up to 3 times their own weight. When they are in orbit, however, they feel weightless.

*Olga:* And how does the shuttle find its way when in space?

*Astronaut:* Using the global positioning system (GPS), of course. Pilots essentially run the computers, which fly the shuttle.

*Olga:* How interesting! But how is electrical power supplied to all on-board systems of the orbiter?

*Astronaut:* Electricity is generated by fuel cells. They combine oxygen and hydrogen to make electricity for on-board systems and water for cooling.

*Olga:* What is the major role the shuttle plays today?

*Astronaut:* Well, it is used for building the International Space Station by delivering components built on the Earth and attaching them to existing modules in space.

#### III. Complete the dialogue.

- ...?
- Well, they combine the features of a rocket, a spaceship, and an airplane.

- And do shuttles differ ...?
- Of course they do! ...
- I wonder how much power is necessary to ...?
- ...
- What does the crew experience ...?
- ...
- Do you know how shuttles navigate in space?
- .... They use ...
- Is the electricity for the on-board systems provided by batteries?
- ...
- Shuttles are very important for building ...?
- ...

#### IV. Match a line in A with a line in B.

- | A   | B  |
|---|--|
| 1. Do you know when shuttles appeared?  | a) Without any doubts.                                   |
| 2. Did he tell you what he experienced at the take-off?   | b) Water.  |
| 3. I wonder how the on-board computers fly the shuttle.   | c) From the GPS satellites.                              |
| 4. Where do the flight computers get the information about the position and the speed of the orbiter? | d) They talk to each other and vote to settle arguments. |
| 5. What did he say was the by-product of the fuel cell?   | e) He felt his body thrice as heavy.                     |
| 6. I wonder if tourists will fly to space in the near future.   | f) Sure. In the 1980s.                                   |

### Language Practice

#### Vocabulary

I. Match the words with the similar meaning.

- |            |           |
|------------|-----------|
| sputnik    | unique    |
| spacecraft | transport |
| concept    | spaceship |
| deliver    | fire      |

essentially	fuel
ignite	satellite
irreplaceable	idea
propellant	basically

## II. Find eight pairs of words with the opposite meaning.

external, reusable, reliable, entry, to disconnect, connected, disposable, finally, internal, initially, unsafe, to land, separate, exit, to attach, to take off

## III. Find in each line the derivative from the first word.

1. ship - sheep, spacecraft, spaceship, shopping
2. to boost - establish, obstacle, stability, booster
3. to combine - combination, connection, cavity, invention
4. to deliver - driver, delivery, despite, drastically
5. to ignite - initially, introduction, excitement, ignition
6. load - leader, payload, launch, loudly
7. use - ultrasonic, successful, reusable, fusion
8. weight - width, weightless, widely, well-known

## Grammar: Reported Questions

### IV. What does (did) the student want to know? Report his special questions.

EXAMPLE 1: *How do they increase the speed of the spacecraft? (to ask)*

He asks how they increase the speed of the spacecraft.

He asked how they increased the speed of the spacecraft.

1. How does a shuttle differ from a spaceship? (to wonder)
2. What properties does the shuttle tile have? (to ask)
3. What components does the shuttle consist of? (to be interested)
4. When is the rocket booster ignited? (to want to know)
5. Where are shuttles applied? (to wonder)

EXAMPLE 2: *What did you experience at the take-off? (to ask)* He asks what I experienced at the take-off. He asked what I had experienced at the take-off.

1. How did the engineers reduce the weight of the orbiter? (to ask)
2. How did the ceramic tile protect the shuttle during the re-entry? (to be interested)

3. Why did they change the design of the external fuel tank? (to want to know)
4. When was the first satellite placed in orbit? (not to know)
5. What materials are used in making the components of a shuttle? (not to be sure)

EXAMPLE 3: *When will tourists fly into space? (to ask)* He asks when tourists will fly into space. He asked when tourists would fly into space.

1. How will the engineers improve the living conditions of astronauts? (to wonder)
2. Why will any meteorite burn in the atmosphere? (to question)
3. What payload will the shuttle deliver to the space station? (to inquire)
4. In what way will the innovations influence the performance of the engines? (to ask)
5. When will spaceships develop the speed of light? (to be interested)

### V. What general information does (did) the student want to know? Report his questions. Use the verbs *to ask, to inquire, to be interested, to question, to wonder*.

EXAMPLE 1: *Is the external fuel tank made of aluminium?*

He asks if (whether) the external fuel tank is made of aluminium.

He asked if (whether) the external fuel tank was made of aluminium.

1. Is it difficult to become an astronaut?
2. Are there good living conditions aboard the spaceship?
3. Does the shuttle develop the speed of light?
4. Does the crew feel weightless when in space?
5. Have the astronauts repaired the damaged satellite?

EXAMPLE 2: *Were there any difficulties during the mission?*

He asks if (whether) there were any difficulties during the mission.

He asked if (whether) there had been any difficulties during the mission.

1. Was the re-entry successful?
2. Were there any failed missions?
3. Did the first astronauts wear space suits inside the spaceship?
4. Did the re-entry temperatures exceed 1200 °C?
5. Did the main engines generate the maximum thrust at the launch?

EXAMPLE 3: *Will future shuttles carry more weight in payload?* He asks if (whether) future shuttles will carry more weight in payload.  
He asked if (whether) future shuttles would carry more weight in payload.

1. Will rocket scientists create a 100% -recoverable spaceship?
2. Will space stations be placed in orbit at Lagrange points?
3. Will artificial gravity allow to create space colonies?
4. Will the solid rocket boosters be processed and re-used?
5. Will the shuttle programme be shut down?

**VI. Fill in the gaps with the suitable linking words (if/when/why /etc.).**

1. I'd like to know ... heating influences the shuttle tile.
2. She asked ... the launch had been successful.
3. The teacher inquired ... the students could explain the difference between a shuttle and a spacecraft.
4. I was interested ... the International Space Station would be built.
5. They were not sure ... the main engines failed.
6. Could you tell me ... the space shuttle delivers the satellites?

**VII. Correct mistakes in these sentences.**

1. The student asks whether the first spaceships had been recoverable.
2. They wondered if did we observe the launch of the shuttle.
3. Nick was interested what components did the space shuttle consist of.
4. He wanted to know why isn't the fuel tank painted white.
5. I was asked did I specialize in insulating materials.
6. My friend inquired if I will graduate from the University soon.
7. We wonder how have they obtained the required propellant.
8. She asked did I know anything about the global positioning system.
9. They were interested if space tourism will develop in the near future.
10. The engineers knew where was the space station.

**VIII. What are the questions the teacher actually asked?**

After our meeting with the famous astronaut the teacher asked whether we had liked the conversation. Then he asked what interesting information we had obtained about the life at the space station. He inquired where the astronauts lived, what they ate and how they felt in microgravity. He was interested what tasks the astronauts performed in space. The teacher wondered if electricity was generated aboard the shuttle. He also wanted us to explain why the shuttle didn't burn during the re-entry. The last question was when we would be able to travel in space.

**IX. Translate the sentences into English using your active vocabulary.**

1. Он спросил меня, что такое 'шатл'.
2. Она поинтересовалась, влияет ли невесомость на свойства вещества.
3. Студентам было интересно, как уменьшили вес внешнего топливного бака.
4. Скажите, пожалуйста, может ли космический корабль развить скорость света?
5. Профессор объяснил, почему были созданы космические корабли многоразового использования.
6. Я хотел узнать, какое топливо используют ракеты-носители.

## Reading and Speaking

**I. When the Soviet Union's 'Sputnik I' was successfully launched and orbited the earth in 1957 the Space Age began. A lot of significant events have taken place since that time. Do you know all of them? Match the event with the appropriate year.**

- |  |      |
|--|------|
| 1. The first space shuttle was launched.   | 1957 |
| 2. Alexei Leonov made the first walk in space (i.e. left his spacecraft).                                    | 1961 |
| 3. Yuri Gagarin orbited the Earth.   | 1963 |
| 4. The Apollo programme sent the first people (Neil Armstrong, Buzz Aldrin and Michael Collins) to the Moon. | 1965 |
| 5. The Soviet Union sent the first living creature into space. It was a dog, Laika by name.                  | 1969 |
| 6. 'Vostok 6' carried the first woman into space. Her name was Valentina Tereshkova.                         | 1981 |

**II. These words are taken from the text. Use the dictionary to find out their meanings.**

- |                    |               |
|--------------------|---------------|
| fiction, n         | astronaut, n  |
| Pharmaceuticals, n | one-shot, adj |
| place, v           | mission, n    |
| compartment, n     | lifetime, n   |
| recreation, n      | undergo, v    |
| dock, v            | refit, n      |
| one-shot, adj      | safe, adj     |

**III. Look at the picture and the title and try to guess what the text deals with. Skim the text to see if you were right.**

**IV. Read the text attentively and say what you have learnt about space shuttles.**

## A Brief History of the Space Shuttle

From the early days of science fiction and space exploration, we have dreamed of space stations. For some, space stations are a place to do scientific research. For others, space stations are a place for business, where unique materials (crystals, semiconductors, Pharmaceuticals) are manufactured in better forms than on the Earth. Still others want to use space stations in order to travel to other planets and stars.



The Russians were the first to place a space station, called Salyut 1, in orbit in 1971. It was about 45 ft (15 m) long and held three main compartments that housed dining and recreation areas, food and water storage, a toilet, control stations, exercise equipment and scientific equipment. (See the picture of the Salyut-4 space station docked to a Soyuz spacecraft.) Are you interested how people get to space stations?

At that time, the rockets used to place astronauts and equipment in outer space were one-shot disposable rockets. The idea of a reliable, less expensive, recoverable and reusable "space shuttle" that could launch like a rocket but deliver and land like an airplane was appealing and would be a great technical achievement. However, nobody knew how that idea could be put into practice.

Design, cost and engineering studies on a space shuttle began. The concepts varied greatly but in 1972, it was decided that the shuttle would consist of an orbiter attached to solid rocket boosters and an external fuel tank because this design was considered safer and more cost-effective. The space shuttle is the world's first reusable spacecraft, and the first spacecraft in history that can carry large satellites both to and from orbit. The shuttle launches like a rocket, maneuvers in the Earth orbit like a spacecraft and lands like an airplane.

Finally, after many years of construction and testing (i.e. orbiter, main engines, external fuel tank, solid rocket boosters), the shuttle was ready to fly. Four shuttles were made (Columbia (1979), Discovery

(1983), Atlantis (1985), Challenger (1991) and each of them was designed to fly at least 100 missions. The first flight with the space shuttle Columbia in 1981 was quite successful. But in 1986 one of the shuttles in operation (Challenger) disintegrated shortly after its launch killing the crew. It had been the only failed mission till February 2003 when Columbia disintegrated before landing. So far the launch of the shuttles has been suspended but they plan to start operating them in the nearest future. The space shuttles have flown about one-fourth of their expected lifetime and now the scientists are working at making numerous refits and design changes to make them safer.

**V. Say if the following statements are true or false. Correct the false statements.**

1. Since ancient times people have dreamed of space stations.
2. Space stations serve numerous important purposes.
3. The Russians were the first to build a space shuttle.
4. Early rockets could be used once only.
5. The shuttle consists of main engines attached to solid rocket boosters and a fuel tank.
6. The fuel tank is situated inside the shuttle.
7. The shuttle is a rocket, a spacecraft and an airplane combined.
8. Columbia, Discovery, Atlantis, Challenger are operating quite successfully at present.
9. Modern shuttles have become safer and more efficient in operation.

**VI. Explain why ...**

- a) space stations are created,
- b) first spaceships were not cost effective,
- c) shuttles were developed,
- d) shuttles are considered a unique means of transport,
- e) shuttles have undergone many refits and design changes.

**VII. April 12 is the International day of Cosmonautics. The first shuttle, Columbia, was also launched on April 12, 1981. Your friend has just found it out and is very surprised. He has come to you for more information about shuttles. Answer your friend's questions about the history of shuttles and explain to him why and how shuttles are constructed.**

**VIII. Make a list of ways in which achievements in space engineering may be used nowadays and in the future. Compare your list with that of your groupmates.**



## Further Reading

I. These words are taken from the text. Use the dictionary to find out their meanings.

awesome, adj	ratio, n
take off, v	vapour, n
shut down, v	nozzle, n
aft, adj	gimbals, n
fuselage, n	mount, v
remainder, n	feed, n
Pad, n	tail, n

II. Scan the text to find answers to these questions.

1. How much does the shuttle weigh?
2. What parts does the shuttle consist of?
3. What fuel do the rocket boosters use?
4. Why is it impossible to shut down the boosters after they are ignited?
5. Where are the orbiter's main engines located?
6. What exhaust gases do the orbiter engines emit?
7. How is the forward direction of the rocket controlled?
8. What does the work of the orbital maneuvering systems' engines depend on?

III. Read the text attentively and learn how the shuttle works.

The launch of a space shuttle is one of the most awesome spectacles of our time.

In order to get into orbit 115-400 miles / 185-643 km above the Earth, the 2,000 tonne shuttle uses the following components:

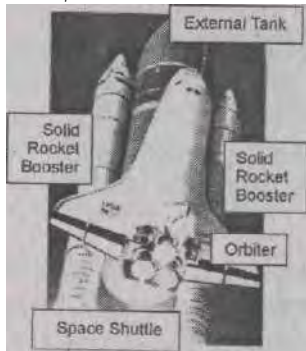

- two solid rocket boosters (SRB) - critical for the launch;
- external fuel tank (ET) - carries fuel for the launch;
- orbiter - carries astronauts and payload; three main engines and orbital maneuvering system (OMS).

Let's look at these components closely. The SRBs are solid rockets that provide most of the thrust (71 %) needed to take off. The SRBs carry rocket motors, solid

propellant (atomized aluminum), flight instruments, parachutes and self-destruct mechanism. As the SRBs are solid rocket engines, once they are ignited, they cannot be shut down. Therefore, they are the last component to light at the launch.



The orbiter has three main engines located in the aft fuselage. They provide the remainder of the thrust (29 %) to lift the shuttle off the pad and into orbit. The engines burn liquid hydrogen and liquid oxygen, which are stored in the ET, at the ratio of 6:1. The fuel is partially burned in a pre-chamber to produce high pressure by hot gases that drive the fuel pumps. The fuel is then fully burned in the main combustion chamber and the exhaust gases (water vapour) leave the nozzle at approximately 6,000 mph / 10,000 km/h. The rate of thrust can be controlled from 65 % to 109 % maximum thrust. The engines are mounted on gimbals that control the direction of the exhaust, which controls the forward direction of the rocket.

As mentioned above, the propellant (about 526,000 gallons / 2 million litres) for the main engines is stored in the ET. The ET is made of aluminum composite materials. It has two separate tanks inside, one for oxygen and the other for hydrogen, separated by an intertank region. The fuel flows from each tank through a 17 in. (43 cm) diameter feed line out of the ET into the shuttle's main engines. During the first few shuttle missions, the ET was painted white, but this was stopped to reduce the weight.

The two orbital maneuvering systems' (OMS) engines are located on the aft section of the orbiter, one on either side of the tail. These engines are used to place the shuttle into final orbit, to change the shuttle's position from one orbit to another, and to slow the shuttle down for the re-entry. Either one or both of the OMS engines can fire, depending upon the orbital maneuver. Now let's put these pieces together and see how the shuttle will lift off!

IV. Choose the correct option to complete the sentences.

1. The space shuttle has ... major components.  
a) three; b) four; c) five
2. Most of the thrust (71 %) for the take-off is provided by ....  
a) the rocket boosters; b) the orbiter's main engines;  
c) the OMS engines
3. The rocket boosters consume solid ....  
a) propeller; b) propane; c) propellant

4. As the SRBs cannot be shut down after the ignition they are the ... component to light at the launch.  
a) first; b) next; c) last
5. The orbiter's main engines run on ... oxygen and hydrogen.  
a) solid; b) liquid; c) gaseous
6. The orbiter's engines burn liquid hydrogen and liquid oxygen at the ratio of ... .  
a) 1:6; b) 6:1; c) 6:1:6
7. The exhaust gases leave the ... at approximately 6,000 mph / 10,000 km/h.  
a) nozzle; b) aft; c) combustion chamber
8. The external fuel tank is for storing ....  
a) atomized aluminum; b) liquid hydrogen and liquid oxygen; c) water vapour
9. Liquid hydrogen and liquid oxygen are stored in ... tanks.  
a) the same; b) similar; c) separate
10. The external fuel tank is not painted white in order to ... the weight.  
a) increase; b) reduce; c) conserve
11. The two orbital maneuvering systems' engines are used to ... the shuttle for the re-entry.  
a) slow down; b) speed up; c) shut down

**V. Complete the table with the data from the text.**

<i>Acronym</i>	<i>Component</i>	<i>Function</i>
SRB	...	...
ET	...	...
OMS	...	...
–	orbiter	...
–	...	to provide the thrust (29%),...
–	gimbals	...
–	...	to control the forward direction of the rocket
–	an intertank region	...

**VI. Give a title to the text.**

## Activity

**I.** Your space shuttle 'Belarus' has just successfully landed and you have been asked to give a lecture at the Technical University about the work of your shuttle. Describe your previous shuttle flight and show the pictures. Be ready to answer the students' questions.

**II.** The year 2001 saw an unprecedented event when the first tourist had a chance to travel into space. What do you think about the future of cosmonautics? Discuss this problem with your groupmates. Give your reasons. The phrases below will help you.

- space tourism will develop
- anybody will have a chance to travel to another planet
- there will be cities on other planets
- in schools children will study a new subject "Rules of behaviour in space"
- we will not have bicycles or cars, everybody will travel in jet aircraft

## Writing

**I.** You have been given the photo (below) and the task to write a short article for the Day of Cosmonautics. In the article express your opinion on the past and the future of space travel.

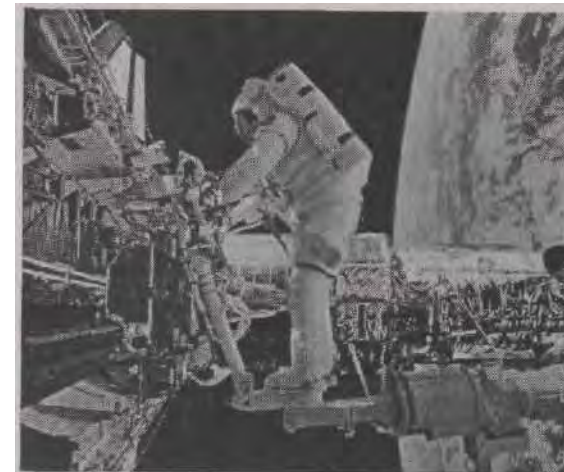

II. Translate the following passage into Russian. Use the dictionary if necessary.

### What Is the Difference Between the Space Shuttle and the Meteor?

When the orbiter hits the atmosphere, the air in front of it compresses incredibly quickly. This causes the re-entry temperatures to rise as high as 3,000 °F (1,650 °C)! **Do you know what technologies** allow spacecraft to re-enter and land safely? In ablative technology, the surface of the heat shield melts and vaporizes carrying away the heat. This is the technology that protected the Apollo spacecraft. However, to be reusable, a different strategy has to be used. The designers of the space shuttle came up with an idea to cover the space shuttle with many insulating ceramic tiles that could absorb the heat of the re-entry without harming the astronauts. Aerobraking tiles are produced from amorphous silica fibers which are pressed and sintered, with the resulting tile having as much as 93% porosity (i.e. very lightweight) and low thermal expansion, low thermal conductivity (you can hold a space shuttle tile by the corners when the center is red hot), and good thermal shock properties. These tiles keep the heat of the re-entry from ever reaching the body of the shuttle.

## CHECK YOUR PROGRESS

---

### Grammar Check

#### *I. Infinitive*

##### **I. Find Infinitives or Infinitive constructions in the following sentences.**

1. I wanted you to help me to weld these two pieces by an electric arc.
2. He suddenly felt the electrode touch the surface of the workpiece.
3. Robots are supposed to facilitate people's work.
4. The short circuit is reported to have caused a lot of damage.
5. To drive safely it is important to check the brake system regularly.
6. All this makes me think that it is fascinating to experiment with lasers.
7. You are likely to spot distant planets if you know about Doppler's effect.
8. Ecologists would not like CFCs to be used as industrial gases.
9. The material to be investigated is of great value.
10. The need to develop stronger alloys forces the experiments to be continued.

##### **II. Insert *to* where necessary.**

1. You should ... recharge your car battery directly.
2. He made me ... use protective clothing during welding.
3. We would like you ... show us how the actuator works.
4. The function of a thermometer is ... measure the temperature.
5. ... obtain an alloy, one must... mix metals with non-metals.
6. The distance ... be measured is between these two points.
7. Professor watched the students ... quench a steel bar in oil.
8. Don't let children ... play with matches.
9. Domestic appliances are supposed ... consume plenty of electricity.
10. It is obviously necessary ... demonstrate the properties of this substance to the researchers.

### III. Translate the following sentences into English.

1. При проведении дуговой сварки, необходимо правильно пользоваться инструментом и соблюдать технику безопасности.
2. Прибор, который нужно использовать, имеет совершенно новую конструкцию.
3. Целью данной статьи является описание преимуществ использования электрических автомобилей.
4. Такая система позволяет генерировать мощный электрический ток.
5. Возможно, автомобиль имеет серьезные повреждения.
6. Сообщается, что экспериментальный микроскоп работает достаточно эффективно.

## II. Participle

### I. Find Participles or Participial constructions in the following sentences.

1. You have come early. The experiment is still being carried out,
2. When carried out, the experiment was discussed with great interest.
3. Being translated into many foreign languages, her works are read with great interest all over the world.
4. Having studied the properties of the alloy the engineer made a report on the subject of his research.
5. The hologram having been made, we switched off the laser.
6. The results received were of great importance for further investigations of artificial stars.
7. Having been taught by a good teacher, I know Geodesy well.
8. When burnt, coal produces not only heat but polluting gases as well.
9. They tried to repair the engine trouble following the instructions of a mechanic.
10. The professor delivering a lecture on nanotechnology mentioned interesting facts.

### II. Choose the right option.

1. The canal *связывающий* the two seas is being built now.  
a. having linked b. linking c. linked
2. The explanation *данное* is not complete.  
a. given b. being given c. giving
3. *При нагревании* metals expand.  
a. when heating b. when heated c. when having been heated
4. *Work done*, you have fun.  
a. сделанная работа b. когда работа сделана c. делая работу

5. *Анализируя* elements Mendeleev divided them into 9 groups.  
a. studying b. having studied c. studied
6. *Получив* good results we stopped the research.  
a. being received b. having received c. receiving
7. Life *existing* on other planets is no longer under question.  
a. существуюя b. существовавшая c. существующая
8. *Being built* on time the bridge was opened for public use.  
a. будучи построенным b. построив c. строящийся
9. *Having been shown* the design I found the fault quickly.  
a. показав b. показывая c. после того, как мне показали
10. While *calculating* the speed the student made a mistake.  
a. вычисляющий b. вычисляемый c. вычисляя

### III. Translate the following sentences into Russian.

1. Проверив электрическую цепь, он начал наблюдать за показаниями приборов.
2. При проведении исследований мы использовали этот микроскоп.
3. Полученное оборудование устанавливают в данный момент в нашей лаборатории.
4. Занимаясь исследованиями, он пришел к выводу о возможности применения нового материала в электронике.
5. Воспользовавшись мощным лазером, мы создали голограмму, видную издалека.

## III. Gerund

### I. Find Gerunds or Gerundial constructions in the following sentences.

1. The teacher insists on our coming on time.
2. We don't know much of the Challenger having failed its mission.
3. The value of his having discovered natural lasers is not realized completely yet.
4. The idea of connecting these wires was not mine.
5. Using renewable resources can significantly reduce the amount of air pollution.
6. I don't mind your reading science magazines in the reading room.
7. We hear of the up-to-date equipment being bought for your lab.
8. He was sure of repairing the ignition system without anybody helping him.
9. Exploring other worlds by means of robots soon will become a reality.
10. Seeing is believing.

## II. Choose the right option.

1. ... heavy units is not easy.  
a. assembling    b. assembled    c. being assembled
2. The teacher does not know of the students ... the apparatus.  
a. damaging    b. being damaged    c. having damaged
3. New possibilities for ... atomic energy open up.  
a. applying    b. having applied    c. applied
4. The projects of ... waste-to-energy plants cause fierce opposition.  
a. constructing    b. having constructed    c. being constructed
5. Instead of ... the old air-filter they replaced it with a new one.  
a. having cleaned    b. cleaned    c. cleaning
6. You can improve your work efficiency by ... modern technologies.  
a. applying    b. having applied    c. applied
7. What device do taxi-driver use for ... passengers?  
a. charged    b. being charged    c. charging
8. They are talking about the shuttle ... already.  
a. launched    b. being launched    c. having been launched
9. He always operates the apparatus without... safety regulations.  
a. observed    b. observing    c. having observed
10. They insist on the short circuit...  
a. being avoided    b. avoiding    c. having avoided

## III. Translate the following sentences into Russian.

1. Составление новой компьютерной программы было нелегкой задачей,
2. Решение данной проблемы невозможно без проведения серии экспериментов.
3. Вы можете рассчитывать на то, что компьютер выдаст вам точную информацию.
4. Роботы способны выполнять тяжелую работу не уставая.
5. Мы осведомлены о том, что он сейчас исследует свойства нового сплава.

## IV. Reported Speech

### I. Correct mistakes and translate the sentences into Russian.

1. They announced that the new vehicle will be widely used in the future.
2. The article said that rain forests are badly damaged by acid rains.

3. She asked Denis if when the Science Museum had been opened in London.
4. We are all interested is there life on Mars.
5. The student answered that he never heard of the Doppler effect.
6. The student was asked that to enumerate advantages of personal computers.
7. I was interested if were actuator robots more mechanically efficient.
8. They wondered why were those devices made of quenched steel.
9. The engineer said to us not to touch the wire while the power was on.
10. Can you tell me how does a power plant generate electricity?

### II Choose the right option.

1. It was reported they ... their research 2 days before.  
a. had carried out    b. would carry out    c. carried out
2. The inventors were interested who ... finance the further research.  
a. would    b. will    c. -
3. The miners did not know what... the explosion.  
a. causes    b. caused    c. had caused
4. She asked how often ... in various scientific projects.  
a. did you participate    b. you did participate    c. you participated
5. The instructor advised us ... driving during rush hours.  
a. to avoid    b. that we avoided    c. avoid
6. They were certain they *would win* the race.  
a. выиграли    b. выиграют    c. выигрывают
7. He said the device *needed no* improvement.  
a. не нуждается    b. не нуждался    c. не будет нуждаться
8. That article said that the hail *had damaged* many cars.  
a. повредит    b. повреждает    c. повредил
9. We were asked if we *believed* in artificial and alien intelligence.  
a. поверим ли    b. верили ли    c. верим ли
10. They wanted to know ... the fault had been found. a. -  
b. if    c. who

### III. Translate the following sentences into Russian.

1. Он сказал, что эти пластины делают из закаленной стали.
2. Как вы думаете, что вызвало данный эффект?
3. Они поинтересовались, экспериментирую ли я со сплавами.
4. Ученые объявили, что с помощью биотехнологий они создали новый сверхпрочный материал, свойства которого они сейчас изучают.
5. Сообщалось, что существует возможность создания искусственного разума.

## Translation Check

Choose one of the paragraphs and translate it in writing. Use the dictionary if necessary

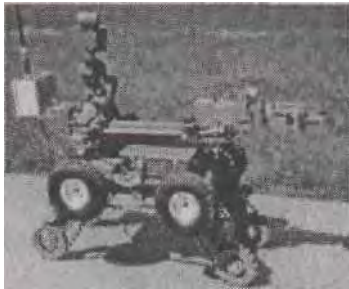

1. *Bomb Buster*. The Mini-Androsis is used by bomb squads across the country to locate and dispose of bombs. About three feet long, the Mini-Androsis looks something like a small armoured tank with eight wheels on four 'legs' that extend for climbing stairs. Its movable arm can lift objects weighing up to 15 pounds and place them in bombproof boxes. Detachable accessories allow the Mini-Androsis to break

windows, to see in the dark, and to defuse or detonate bombs directly, either by blasting them with water, firing at them with a shotgun, or placing other smaller bombs nearby.

2. There is a lot of debate at present about the best way of *disposing of the domestic waste* we generate. In the past it was dumped in holes in the ground - old quarries and sand or gravel pits. Such landfill sites are limited in number. They also have to be prepared and managed carefully to prevent chemicals from the waste polluting underground water, streams and rivers. Where organic waste is disposed of to landfill and then decomposes it is known to produce methane gas, with explosive consequences. What are other options for waste disposing? Alternatives to landfill are generating less waste, recycling (including not only useful materials such as tins, paper and glass but also organic matter that can be composted) and burning waste.

3. *Burning domestic waste* in order to reduce its amount and to release useful energy is being much discussed today. A lot of such waste-to-energy plants proposed across the UK are causing strong opposition. The engineers developing and managing these plants work within much tighter guidelines and restrictions than was once the case. Although recycling is uncontroversial and many people support well-organized schemes, there is concern about the potential dangers of such power stations. The Environmental Protection Agency has published a report on problems arising from incinerating waste. It claimed that such projects were perhaps more dangerous than it was thought. One person's waste-to-energy plant is another's incinerator.

4. *Marine scientists use three types of vehicle to explore and work in the deep sea.*

a) *Manned submersible* usually carry three people, including a pilot, to the ocean floor. To resist the crushing pressure of the water at such depths, the crew occupies a steel or titanium sphere less than 2 metres across inside. A typical dive lasts for around 8 hours. Manned submersibles are not connected to the surface and carry their own power in batteries. Mechanical arms, controlled from inside the sphere, allow the crew to collect samples and conduct experiments on the ocean floor. At present, there are only five vehicles in the world that can carry people to a depth of 6,000 metres - just over half way to the deepest point in the oceans.



b) *Remote operated vehicles (ROVs)* are unmanned and connected to a surface ship by a long tether cable. The operators control the vehicle from the ship, sometimes using 'virtual reality' to create the impression of being on the sea floor themselves. Being supplied with power from the ship through their tether cable, ROVs do not need to carry batteries. There being no people or batteries on board, ROVs can stay on the ocean floor to work for much longer periods of time than manned submersibles.

c) *Autonomous underwater vehicles (AUVs)* are also unmanned, but they are not connected to a ship. Instead, AUVs are programmed in advance and launched from a ship to explore an area and collect samples by themselves. These robot submarines are ideal for investigating hard-to-reach areas such as beneath polar ice shelves, where using manned submersibles is too dangerous and ROVs cannot go because of their tethers.

5. *Making high-quality alloy products* is a complex process including many stages.

a) *Quenching* is defined as rapid cooling by placing in oil or water, of a metal object from the high temperature at which it is shaped. This is usually done to maintain mechanical properties that will be lost with slow cooling. Quenching is commonly applied to harden steel objects. On the contrary, *tempering* is known as heat treating of metal alloys,



particularly steel, to impart specific properties. For instance, **heating hardened steel to 752 F (400 °C) and holding it for a time** before quenching in oil decreases its hardness and brittleness and produces strong and tough steel. Quench-and-temper heat treating is applied at many different cooling rates, holding times, and temperatures, and is a very important means of controlling the properties of steel.



b) *Casting* is the process of pouring molten metal into a mold, where it solidifies into the shape of the mold. The process was well established in the Bronze Age, when it was used to form bronze pieces now found in museums. It is particularly valuable for the economical production of complex shapes, ranging from mass-produced parts for automobiles to one-of-a-kind production of statues, jewelry, or massive machinery. Most steel and iron castings are poured into silica sand. For metals of lower melting point, such as aluminium or zinc, molds can be made of metal or of sand.

6. *Home-made Electricity?* Two wires of different metals (e.g. iron and copper), an alcohol / gas flame and an earphone are needed for the experiment. Try connecting the wires to the earphone and rubbing their ends in the flame. This will let you hear sounds caused by a small electric current being produced in the heated wires. Can you explain how it works? Each metal has its own natural rate for losing electrons. The contact being made, heat forces a more active metal to loose some electrons from its surface to a less active metal. This transfer of the electrons is the electric current. Try putting the ends of the wires into salt water and rubbing them together while in the solution. This will allow electricity to be produced, not by heat but by chemical action.

7. *Natural infrared lasers* are very rare in space. However, it was reported that a powerful ultraviolet laser beam, several million times brighter than our Sun, shooting toward Earth from a super-hot 'death star' located 8,000 light-years away had been observed with NASA's Hubble Space Telescope. The astronomers identified a gas cloud acting as a natural ultraviolet laser, near the huge, unstable superstar called Eta Carinae - one of the most massive and energetic stars in our Milky Way Galaxy. The ultraviolet laser in Eta Carinae shines in the same way as artificial optical lasers and similar, microwave devices called masers. The discovery will provide scientists with a new tool for studying how monster interstellar lasers actually work.

## Writing

a) Read these advertisements below and choose the one you like most.

<p><b>Design Engineer</b></p> <p>We are a long established large engineering company specializing in mechanical equipment and require to appoint a design engineer for our design office. The applicant should be aged between 24-36 and must have a sound and practical engineering background. <b>He/She</b> should have experience in lorry attachments and conveyor systems; must be able to work on his/her own initiative and be very active. This is an extremely responsible position with good prospects for further advancement. Please reply in own handwriting with your CV to:</p> <p>Minsk Tractor Works 29 Dolgobrodskaya street 220668 Minsk, Belarus</p> <p style="text-align: right;">tel/fax: 2272166</p>	
<p style="text-align: center;"><b>Quality Engineer</b></p> <p>The Instrument-Making Plant now has an opening for a Quality Engineer to take full responsibility for ensuring quality-related activities. Educated to at least BA degree level in mechanical engineering, experience in quality improvement in instrument-making industry will be a distinct advantage. A working knowledge of problem-solving techniques is essential. There will be excellent opportunities for career development as the company continues to grow.</p> <p>To apply, please send a CV to:</p> <p>Sergei Levashov, Instrument-Making Plant 31 Kulman street 220310 Minsk, Belarus</p> <p style="text-align: right;">Deadline is Friday April 25</p>	<p style="text-align: center;"><b>Analyst Programmer</b> <u>Salary \$ Negotiable</u></p> <p>A growing company requires an analyst programmer with at least two years' "C+" or "Java" experience. You will need excellent interpersonal and communication skills and be able to work effectively as a member of a team. We offer an attractive range of benefits and prospects to our employees, including life assurance, permanent health insurance and the company car. Apply in writing enclosing your CV to:</p> <p>Alexey Petrov IBA 10 Yakub Kolas Sq. 220015 Minsk, Belarus</p>

b) Write your CV and a letter of application for the post you've chosen.

# SUPPLEMENTARY READING

## TEXT 1

### I. Scan the text to find answers to these questions.

1. Is the function of the car very complicated?
2. What features affect the car design today?
3. How does the Hy-wire differ from the conventional car?
4. Why is there no engine compartment in the Hy-wire?
5. Where is all the equipment positioned?
6. How is the Hy-wire operated?
7. What are the major problems of the Hy-wire to be solved in the near future?

### II. Read the text attentively for more details about the unusual car.

#### How GM's Hy-wire Works



GM's sedan model Hy-wire

Cars are very complicated machines with an incredibly simple job of turning wheels. The overall function of the car being so basic, does it actually need all those complex heavy devices? Most likely, a lot of us will be driving radically different vehicles within 20 years. Two basic elements dictating car design are the internal combustion engine and mechanical and hydraulic linkages. The defining feature of the Hy-wire is that it has neither of them. The engine is replaced with a fuel cell stack, which powers an electric motor connected to the wheels. A computer-based drive-by-wire system substitutes the linkages.

These changes result in a very different car - and a very different driving. There are no pedals, no steering wheel and no engine compartment. In fact, all the equipment moving the car is housed in an 11-inch-thick aluminium chassis at the base of the car. The main computer in the chassis sends electronic signals to the motor control unit to vary the speed, the steering mechanism to maneuver the car, and the braking system to slow the car down. Everything above the

chassis serves only to driver control and passenger comfort, but the coolest thing in this design is the possibility to switch from a van to a sports car just by replacing the car body.

The driver's control unit (X-drive) looks like a video game joystick having two ergonomic grips, to the left and right of a small monitor replacing an instrument panel and giving you a rear view from video cameras (in place of mirrors). Buttons on the controller let you switch easily from neutral to drive to reverse, and a starter button turns the car on. As it doesn't directly drive any part of the car, the X-drive controller can be moved freely in the passenger compartment. A second monitor provides stereo, climate control and navigation information.



There are no ideal cars as yet. Safety is a big concern with drive-by-wire cars since electrical failure means the total loss of control. The other burning issue is developing energy-efficient methods of supplying hydrogen for the onboard fuel-cell stacks. Assuming that GM can tackle the major fuel and safety issues satisfactorily, the highway will see some major changes within the next few decades.

### III. Choose the correct option to complete the sentences.

1. The simple job of the car consists in ...  
a) turning wheel;                      b) showing video-film;  
c) having complex devices.
2. The major characteristic of the Hy-wire design is the absence of ....  
a) the internal combustion engine;  
b) mechanical and hydraulic linkages;    c) both.
3. The driving system operated by the computer receiving and sending electronic signals is also known as a ... system.  
a) 'fly-by-wire';    b) 'drive-by-wire';    c) 'fuel cell'.
4. The main computer is installed ... the passenger compartment.  
a) in;    b) under;    c) above.
5. Speed, mileage and fuel level information are available to the driver ....  
a) on the monitor of the X-drive;    b) on a video camera;  
c) on the instrument panel..
6. The Hy-wire is started by ....  
a) pushing a button on the X-drive;    b) turning a grip;  
c) observing the monitor.



7. While operating the **Hy**-wire you do not use your ....  
a) hands; b) feet; c) head.
8. To mass-produce the Hy-wire car General Motors will have to solve the problems of ...  
a) passengers; b) highways; c) safety and fuel supply.

**IV. Translation Check. Use the dictionary if necessary.**

### Zero-pollution Cars



The electric car is an environmentally friendly alternative to gasoline-powered vehicles. It performs like a conventional car with one important difference - it is nearly silent and pollution-free. The electric car is propelled by an electric motor powered from a controller, which in its turn gets its power from rechargeable batteries. However, the batteries need replacement every 20,000 miles. Fuel cells solve the battery problem.

A fuel cell is an electrochemical energy conversion device that converts hydrogen and oxygen into water, producing electricity and heat in the process. Unlike a battery, you can continually recharge a fuel cell by adding chemical fuel - hydrogen from an onboard storage tank and oxygen from the atmosphere. The proton exchange membrane fuel cell (PEMFC) seems to be one of the most promising technologies. A single fuel cell produces about 0.7 volts. To get this voltage up many separate fuel cells are combined to form a fuel cell stack.

Zero-pollution cars are also designed to run on compressed air using the concept of the steam engine. Liquid nitrogen stored at -320 °F **serves as** the propellant for the LN2000's cryogenic engine. Air moving around the vehicle heats the liquid nitrogen to the boiling temperature and causes it to turn to gas pushing on the engine's pistons. The only emission being nitrogen (which makes up 78% of the atmosphere), the air-compressed car fully justifies the name of its manufacturer - Zero-pollution Motors.

### TEXT 2

**I. Scan the text to find answers to these questions.**

1. When was the first flying car designed?
2. What models of flying cars have already been designed?

3. What speed can the Skycar develop?
4. Is the Skycar fuel-efficient?
5. What is a 'fly-by-wire system\*?'
6. How does the CityHawk differ from the Skyrider?
7. Why are flying cars designed as an alternative to road cars?

**II. Read the text carefully and say what you have learnt about the new breed of cars.**

### Flying Cars

Just a decade and a half after the Wright Brothers took off in their airplane over the plains of Kitty Hawk, N.C., in 1903, other pioneering men started dreaming of a flying car. The attempt to develop a gliding



horse cart in the 18th century, to no great surprise, failed. Numerous flying cars are being invented today. Moller's latest project, the Skycar M400, is designed to take off and land vertically, like a Harrier Jet, in small spaces. Having a range of 900 miles, it will cruise at around 350 mph with the top speed of 400 mph using petrol, diesel, alcohol, kerosene and propane as fuel. The fuel mileage of the Skycar will be comparable to that of a medium-sized car, getting 20 miles to the gallon. To make the Skycar safe and available to public, it will be completely controlled by computers using the Global Positioning System (GPS) satellites - a so-called 'fly-by-wire system'. In an emergency the vehicle will release a parachute and airbags, internally and externally, to cushion the impact of the crash. The cost of a Skycar is estimated to be \$60,000 if mass-produced.

MACRO Industries' SkyRider X2R will use the same fly-by-wire system to safely transport passengers. Drivers will simply get in, turn on the power and enter the address or phone number of the desired destination, with the SkyRider doing the rest. MACRO said that the system would be fully automatic, but allowing some manual control. Commands will be entered just by telling the car what you want it to do.

Similarly to Skycars and SkyRiders, CityHawks also take off and land vertically. However, there are some key differences. The CityHawk will be powered by fans driven by four internal combustion engines. This number of engines will allow the vehicle to land even if

one of the engines is lost. The CityHawk will have cruising speeds of 90-100 mph. The car is likely to be used as an air taxi, for news gathering and for traffic control.

The mass availability of flying cars can be very scary. Yet, if proper safeguards observed, flying cars will not only cut rush hours and traffic jams, but also they will allow us to live hundreds of miles farther from work and still make it to the office in no time.

### III. Choose the correct option to complete the sentences.

1. The Wright Brothers' invention started the idea of flying ....  
a) horse carts; b) airplanes; c) cars.
2. The first developments of flying cars in the early 1900s were ....  
a) surprising; b) ineffective; c) successful.
3. The Skycar takes off and lands ... .  
a) vertically; b) horizontally; c) spirally.
4. Without refuelling the Skycar can fly ... miles.  
a) 350; b) 400; c) 900.
5. The Skycar uses as much fuel as.....  
a) the Harrier Jet; b) a medium-sized car; c) a GPS satellite.
6. The function of the Skyrider is ... .  
a) to safely transport passengers; b) to sky fight;  
c) to control traffic.
7. The CityHawk will be propelled by ... .  
a) funs; b) fans; c) fins.
8. Flying cars will create problems of ... .  
a) traffic jams and rush hours; b) safety;  
c) moving away from polluted cities.

### IV. Translation Check. Use the dictionary if necessary.

#### A New Form of City Transport?



Just don't call it a high-tech scooter! The Segway is the world's first self-balancing human transporter. It is quite stable on two wheels and runs on ordinary household electricity at the speed of 12 mph having the range of 15 miles. Four major elements of the Segway include the wheel and motor assembly, the sensor system, the circuit board brain and the operator control system. Balancing is controlled by a solid-state silicon gyroscope\* system, which passes all tilt information to the two electronic controller circuit boards comprising 10 onboard

microprocessors, which in total are three times as powerful as a typical PC. Their function is to adjust the speed of several electric motors according to the stability information. The motors, powered by a pair of rechargeable nickel metal hydride (NIMH) batteries, can turn each of the wheels independently at variable speeds. When the vehicle leans forward or backward, the motors spin both wheels forward or backward accordingly to keep from tilting over. When the rider operates the handlebar control to turn left or right, the motors spin one wheel faster than the other, or spin the wheels in opposite directions, so that the vehicle rotates. The machine is unlikely to replace the car but it is a superior option for the city.

\*A basic gyroscope is a spinning wheel inside a stable frame. A spinning object resists changes to its axis of rotation. As the point of applied force moves along with the object itself, it ends up applying force on opposite ends of the wheel — the force balances itself out and the gyroscope maintains the stable position.

### TEXT 3

#### I. Scan the text to find answers to these questions.

1. What is a car?
2. Does the car have many applications?
3. What did the mass production of cars result in?
4. Is the car an efficient means of urban transportation?
5. What problems has the car caused?
6. How do environmentalists suggest improving transportation?
7. What fuel will the cars run on in the future?

#### II. Read the text attentively to learn more about the questions the cars pose.

#### Cars: Passion or Problem?

For many people, cars are more than a convenient form of transportation: they are a source of passion and pleasure. Yet cars can also be a source of many problems.

In 1903, Ford Motors became the first to mass-produce cars. This made the car available to large numbers of people. It has brought people much closer to places of work, study, and entertainment. Many people also work in car-related industries: fixing cars, washing cars, advertising cars and selling car products such as stereos and cellular phones.

Many Americans buy a new car every six years. In fact, there are more cars than people in the United States. In New York City, 2.5 million cars move in and out of the city each day. In this traffic, the average speed is sometimes 8.1 miles per hour. This speed could be easily reached by riding a horse instead of driving a car.

Environmentalists dream of turning parking lots into parks and replacing cars with bicycles. They insist on developing public transportation and point out that it saves fuel and does not damage the environment that much. Many people around the world people are unhappy with car traffic and pollution but they cannot imagine their life without driving.

Still, there is an important question that must be answered: What kind of fuel will be used when gasoline is no longer available? To solve this problem, car companies in Korea, Japan, Europe, and the US develop electric cars that will not require gasoline at all.

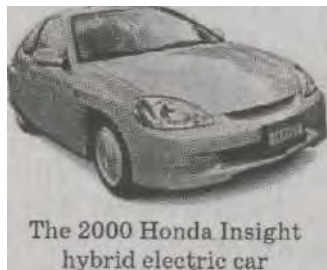

The electric car is not a new idea. Being pollution-free, quiet and easy to start, it had a success with women in the 1900s. But gasoline-powered cars were faster and soon became much more popular. In the 1970s, when there were serious problems with the availability of oil, car companies began to plan for a future without gasoline again. Today's new interest in the electric car is partly related to a passion for

speed and new technology. In 1987 a solar-powered car won a 2,000-mile race in Australia. Air-compressed cars, fuel cell cars, flying cars are currently under development. However, the importance of cars will not decrease, no matter how they change in the future.

### III. Choose the correct option to complete the sentences.

- The major function of the car is to serve as ....  
a) a means of transportation; b) a source of entertainment; c) a source of problems.
- The mass production of cars made the cars ...  
a) large; b) practical; c) available.
- The New Yorkers move at approximately 8.1 mph because they ....  
a) like horse riding; b) are not in a hurry;  
c) stop in traffic jams.
- Environmentalists object to ...  
a) replacing cars with bikes; b) polluting the environment; c) developing public transportation.

- The topical question of the day is ...  
a) what fuel will replace gasoline; b) how much fuel will cost; c) when electric cars will appear.
- Electric cars are being developed because conventional fuel will soon become ....  
a) expensive; b) unavailable; c) inefficient.
- Electric cars lost popularity in the 1920s because they were ...  
a) pollution-free, quiet and easy to start; b) slow; c) driven by women.
- Even if the cars totally change in the future, their importance will not....  
a) increase; b) decrease; c) change.

### IV. Translation Check. Use the dictionary if necessary.

#### Why Bicycle?

A public bus trip here in Greifswald costs 1.50 Euro, the taxi is much more expensive. And it is environmentally dangerous! (Don't forget that Germany is one of the 'greenest' countries in Europe). Maybe that's why most people here prefer a healthy, pollution-free, cheap and convenient vehicle - the bicycle. Indeed, it's as difficult to imagine Greifswald without this kind of 'public transport' as it is hard to imagine this city without students!

The bicycle in Greifswald is a dream of every newcomer. Some of them are lucky to obtain it from their friends, but there are still those who are sadly looking at the daily bike traffic along the streets and go to their workshops on foot. According to unofficial statistics here in Greifswald every person has a bicycle or even two. It's as natural as eating sausages for breakfast. The average commercial price of an average make of a bicycle is around 200 Euro. The average price of a stolen bike at the local 'black market' is much lower -30 - 50 Euro. Here you even have a chance to buy your own bike, stolen last week, though already coloured from pink to blue. If you even don't have a Ferrari, having a new 'Adventure' (probably one of the best makes of a bicycle in Greifswald), sounds quite cool.

P.S.: One thing that every owner of a bike ought to remember: LOCK IT!!!

#### TEXT 4

### I. Scan the text to find answers to these questions.

- What is bicycle riding compared to?
- What forces make the bicycle fall over?

3. What force prevents you from falling when cornering?
4. How is riding 'hands off possible?
5. Why is a slowly moving bicycle stable?
6. How does the bicycle rider balance?
7. What should we consider in order to make the bicycle stable and easy to ride?

## II. Read the text attentively to learn more about bicycle riding laws.

### Riding a Bicycle

Why is riding a bicycle so much easier than tight-rope walking if in both cases you are in contact with the ground through two very small areas? This is how physicists explain it.

The bicycle doesn't stay up on its own. It falls over under the influence of the weight ( $mg$ ) acting vertically downwards through the centre of mass and the reaction ( $R$ ) from the ground acting vertically upwards. Some extra forces to keep the bicycle up are clearly needed.

Steering into the direction of fall makes the bicycle travel in a curve. The resulting centrifugal force experienced by the bicycle and the rider pushes them upright again, so correcting the fall. This simple theory of balancing explains why the bicycle cannot be ridden with the front fork locked. However, it does not explain why it is possible to ride 'hands off.

The rotating wheel is observed to be much more stable than the stationary wheel as spinning stabilizes the motion due to the conservation of angular momentum. Also, the precession of the front wheel automatically steers even the riderless bicycle to keep it upright.

At slow walking speed the gyroscopic forces are definitely too weak and riding is controlled by the steering geometry of the bicycle concerning the head angle (the angle of the axis of rotation with the

ground) and the fork rake (it shows the relations of the wheel axle and the rotation axis). They control two important features to do with the bicycle stability. The first is the castor of the front wheel showing how far the point of contact with the ground is behind the steering axis. It determines how strongly steering is self-centering

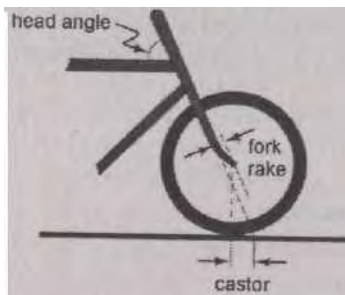

and stable. The second feature is the lowering of the centre of mass by means of turning the handlebars.

This addition to the theory of balance works as follows. As the bicycle begins to overbalance while moving, the handlebars automatically turn in the direction of lean to lower the potential energy. This makes the bicycle travel in the right sort of curve to correct the lean. The castor of the front wheel stops the handlebars from turning too far and forces them to straighten up when the bicycle is upright again. A combination of centrifugal force, gyroscopic action and correct steering geometry gives us a stable bicycle that is easy to ride.

## III. Choose the correct option to complete the sentences.

1. Tight-rope walking is ... bicycle riding.
  - a) much easier than;
  - b) as easy as;
  - c) more difficult than.
2. The bicycle falls over under the influence of ... .
  - a) the center of mass;
  - b)  $mg$  and  $R$ ;
  - c) some extra forces.
3. The centrifugal force pushes the rider ....
  - a) towards the centre;
  - b) away from the centre;
  - c) along the circle.
4. The front fork locked ... .
  - a) causes the centrifugal force;
  - b) makes riding impossible;
  - c) improves your balance.
5. Angular momentum and gyroscopic action make the bicycle ....
  - a) stable;
  - b) rotating;
  - c) stationary.
6. At slow walking speed the stability of the bicycle is controlled by ... .
  - a) gyroscopic forces;
  - b) the head angle and the fork rake;
  - c) the handlebars.
7. The negative castor means that the bicycle is ....
  - a) very unstable;
  - b) super-stable;
  - c) lying flat on the ground.
8. Handlebars are used to ... .
  - a) increase the potential energy;
  - b) raise the centre of mass;
  - c) correct the lean.

## IV. Translation Check. Use the dictionary if necessary.

### Bike Extremes

Understanding how a bicycle balances allows us to design the two extremes - an unridable bicycle and a super-stable bicycle. The first will have a very steep head angle and an enormous fork rake (a). This ensures a negative castor and the centre of mass rises when the

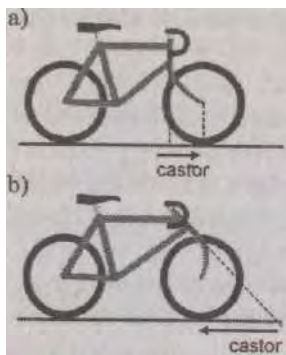

handlebars are turned towards the lean. That is, the handlebars will try to turn in the wrong direction when the bicycle leans over. This bicycle is very difficult to ride. All your skill is needed just to stay upright, and you certainly couldn't ride hands off.

Just by reversing the design we could also make a super-stable bicycle. All we need is a small head angle combined with a negative fork rake as seen in picture (b). This bicycle is so stable that it will travel riderless until it almost stops. However, it is awful to ride. It is too

stable to be steered in any direction desired and only an inert rider with no balancing reflexes and no sense of direction would be happy on such a machine.

The bicycles we normally ride are between these two extremes. For a bicycle to be maneuverable, it should not be too stable, but for safety and ease of use, it should not be unstable. Cycling connoisseurs get their frames hand-made to their own measurements. You can see now how steering geometry will affect the feel and the handling of the bicycle.

## TEXT 5

### I. Scan the text to find answers to these questions.

1. What is the carbon content of steel?
2. How does adding carbon influence the properties of steel?
3. How is tool steel produced?
4. Why are thick tools often soft inside?
5. What drawbacks do carbon steel tools have?
6. Do cooks use knives and other cutlery made of strong carbon steel?
7. In what ways is the quality of steel improved?

### II. Read the text attentively to learn more about the developments in steel making.

#### Steel Quality

In order to understand tool quality, remember that steel is basically iron with a carbon content of 1.7 percent or less. Adding carbon makes the metal harder, but also more brittle, less malleable and less resistant to stress and shock. As tools differ, steel is matched with a suitable carbon content for each tool.

Tool-quality steel must have at least 0.6 % of carbon content. This insures that the steel can be heat-treated. Traditionally, heat **treating involves heating the metal to about 1,350 °F** and then plunging it in to cool water. This abrupt cooling technique, called quenching, changes the carbon particles in the metal into hard carbide crystals. Heat treating produces a hard edge on tools. However, it only penetrates about 1/8" into the metal and thick tools retain a soft center.

Obviously, the quality of each tool depends on the skill of the smith, but many old tools are still in use today. These 'water-hardened steel' tools are made of carbon steel and hold a very keen edge. Yet, they have two serious drawbacks. These tools tend to rust easily and to lose their temper and edge at high temperatures: e.g. carbon-steel drill bits will dull quickly when used in an electric drill; a carbon-steel turning chisel, for use on a lathe, loses its edge when subjected to the friction of the rotating wood.

In order to make better steel, metallurgists experiment with various alloy ingredients. For example, adding tungsten or molybdenum results in high-speed steel resisting a great heat buildup. When buying drill bits, be sure to look for ones made of high-speed steel. Chromium and nickel make steel stainless or rustproof. Early stainless steel knives had one major drawback however; they could not hold a sharp edge the way carbon steel knives could. Chefs and serious cooks preferred carbon steel knives (even though they were prone to rusting) for this reason. Metallurgists gradually improved the quality of stainless steel having developed a grade for cutlery that is rust-resistant and can hold a keen edge.

In addition to creating alloys, manufacturers also improve the techniques of steel making. They have developed special heat-treating ovens and slow-quenching methods so that temper and hardness could be accurately controlled.

### III. Choose the correct option to complete the sentences.

1. Basic steel contains ... 1.7 percent of carbon.  
a) exactly; b) no more than; c) no less than.
2. Steel with a high carbon content is ....  
a) hard and brittle; b) malleable; c) shock and stress resistant.
3. Different tools are made from steels with ... carbon content.  
a) the same; b) different; c) similar.
4. Heat treating produces a hard edge on tools as a result of carbon ....  
a) heating; b) quenching; c) crystallizing.

5. 'Water-hardened ' or carbon steel tools have the advantage of being ....
  - a) wear-proof;    b) rustproof;    c) temperature-proof.
6. The best drill bits are likely to be made of ... steel.
  - a) carbon;    b) stainless;    c) high-speed.
7. Earlier chefs and serious cooks preferred carbon steel knives because they were ....
  - a) sharp;    b) rusty;    c) stainless.
8. The new techniques in steel making aim at... .
  - a) creating special heat-treating ovens;
  - b) developing slow-quenching methods;
  - c) controlling temper and hardness accurately.

**IV. Translation Check. Use the dictionary if necessary.**

### The Rins of Steel

Ancient metal smiths realized that tools would last longer if the hard shell could somehow be inserted in the core of the metal. In Damascus they developed the technique of folding the metal again and again, then hammering it into a solid piece of laminated steel. This method was so successful that Damascus steel became prized throughout the ancient world. The lamination technique was perfected to manufacture samurai swords and continues today in tool making in Japan. However, the Damascus process took time. Each piece had to be tested for quality and there were many rejects. The process was eventually replaced by a less complicated technique. The smith shaped the tool, heated it in the forge, and then quenched it. By carefully limiting the thickness of the tool, the blacksmith could create a tool with the right combination of toughness and hardness.

Are modern tools superior to those of past generations? In general yes, but there are cheap exceptions. Such tools are case-hardened so that the hard exterior is only a fraction of an inch thick. When the tool is sharpened, the hard exterior is ground off; and the tool cannot hold an edge. Some tools look like stainless steel, but they are only nickel-plated. As soon as the plating wears off, the tool begins to rust. You get what you pay for. When it comes to tools, it pays to buy good quality products.

### TEXT 6

**I. Scan the text to find answers to these questions.**

1. What is weathering?
2. What are the main chemical weathering processes?

3. Are there any chemical weathering agents more active than pure water?
4. How does hydrolysis work?
5. Can limestone dissolve in pure water?
6. What role does water play in weathering?
7. What form of weathering is dominant in the desert areas?

**II. Read the text attentively and say what new things you have learnt about weathering.**

### Weathering

Weathering is the general term used to describe the breakdown and alteration of materials near the Earth's surface into products that are more in balance with the physical and chemical conditions experienced there. No rock material can escape the impact of weathering.



The Giants' Causeway

Considering the processes that alter rock at the Earth's surface, we usually distinguish chemical and physical weathering, with water playing the major role. The main chemical processes include solution, hydrolysis, carbonation, oxidation and chelation.

Solution is the process in which minerals simply dissolve in water. It is controlled by the amount of water available and the solubility of material. Although some minerals will dissolve in pure water, the weak acids formed when certain substances (e.g. sulphur dioxide) dissolve in water are more effective weathering agents - remember acid rains!

Hydrolysis describes the direct reaction between water and a mineral in which the material is replaced by hydrogen from water.

Carbonation occurs as follows. Small quantities of carbon dioxide can be dissolved by rainwater to form weak carbonic acid. Additional carbon dioxide can be picked up as water drains through the soil. Carbonic acid is a very effective solvent of carbonate-rich rocks such as limestone, which are only slightly soluble in pure water.

Oxidation describes the reaction of a mineral with oxygen. The oxidation of iron, common in most rock minerals, creates characteristic reddish weathering profiles.

Biological processes (e.g. the decomposition of plant matter) can extract metal cations that would otherwise be insoluble. This process is called chelation.

The chemical processes involved in rock breakdown are complex, but the dominant factor is the supply of water. In desert environments chemical weathering is limited by the lack of available moisture.

Physical, or mechanical, weathering involves changing in volume of within the rock mass causing the pressure release, which normally results in breaking off blocks of the rock. It is evident that physical and chemical weathering processes are closely interrelated.

### III. Choose the correct option to complete the sentences.

1. Weathering is the process of breaking and ... materials near the Earth's surface.  
a) creating; b) changing; c) developing.
2. Weathering influences ... rock materials.  
a) all; b) some; c) no.
3. Solution, hydrolysis, carbonation, oxidation and chelation are ... weathering processes.  
a) physical; b) chemical; c) mechanical.
4. Acid rains are the result of ... of certain gases in water.  
a) solution; b) chelation; c) hydrolysis.
5. Carbonic acid is a very effective solvent of ...  
a) carbon; b) rocks; c) limestone.
6. Reddish weathering profiles are produced by the oxidation of ...  
a) sulphur; b) iron; c) carbon-rich rocks
7. ... is the main component of all chemical weathering processes.  
a) solution; b) balance; c) water.
8. Physical, or mechanical, weathering normally results in ... pieces of rock.  
a) breaking off; b) pressing; c) releasing.

### IV. Translation Check. Use the dictionary if necessary.

#### The Influence of Weathering

Given that all the rocks are heading towards breakdown, weathering poses a number of opportunities and problems for humans. The breakdown of rock material is essential for the

operation of other processes at the Earth's surface. Weathering produces materials, which are then transported by rivers, rain or wind. It also releases minerals from rocks, which are essential in the soil formation. The layer of altered rock created by weathering (termed regolith) contains various minerals that can be concentrated to become economically workable for mining. Bauxite deposits, which are a major source of aluminium ore, are created by tropical chemical weathering. At the same time weathering can create problems for human activity, especially through the damage it causes to building materials. The conservation of our architectural heritage requires action against the effects of weathering. In natural landscapes too, weathering can impose hazards, particularly where it is responsible for weakening rock so that it becomes dangerous. And yet, although the 'breakdown' may imply a negative impact but in fact weathering is the adjustment of materials to more stable states. As such, weathering is an essential link in the cycle of Earth surface materials.

### TEXT 7

#### I. Scan the text to find answers to these questions.

1. What qualities are given to spiders in legends?
2. What are the properties of spider silk?
3. How is the super-strength of spider silk proved?
4. What is silk made of?
5. Where do spiders obtain amino acids?
6. Is the structure of the cobweb homogeneous?
7. Why is the spider's spinning technique environmentally friendly?

#### II. Read the text attentively to learn more about the secrets of spiders.

#### Spiders' Webs

In myths and legends, spiders and their silk webs have equally fabulous properties. Today scientists are trying to solve the secrets of spider silk. Their discoveries may eventually lead to the biosynthesis of a new generation of materials.

Spider silk has extraordinary properties. The web of the garden spider is so fine that we only see it when covered with dew. However, the threads of spider silk are estimated to be much stronger than steel threads of identical



thickness. Experimenting proves that if the web were scaled up, with threads as thick as a pencil, it would be certain to stop a Boeing 747 in full flight. The cobweb is not only strong; it is also able to absorb the energy of the flying object without giving it back. If they did, the web would behave like a trampoline. Instead the recoil is buffered by a mechanism built into the fibre. Engineers could make very good use of a fibre with such amazing qualities. The secret must lie in the structure of silk.

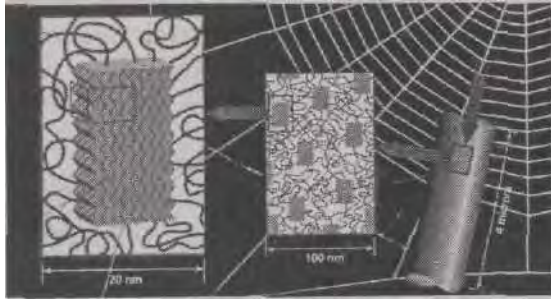

Silk is a protein. Its molecules are made up of long chains of amino acids covalently linked together. Spiders are known to feed on insect protein, which they break down by digestion to amino acids used in the synthesis of silk. Each particular protein has a unique sequence of amino acids. Some chains of protein form nanocrystals making silk fibres smooth and strong. Between the crystals, other lengths of the protein chain form a mass of coils making the web soft and rubbery in order to stretch and absorb the energy of an impact.

Chemists envy the spider's spinning technique because, unlike the processes for making artificial fibres, it is environmentally friendly. Kelvar, the high-tech fibre used in body armour, is spun from concentrated sulphuric acid heated almost to the boiling point. By contrast, spider protein produced as a water jelly by the glands inside the spider is somehow turned into a water-insoluble fibre at the temperature of the spider's surroundings. Besides, the web being broken easily, the spider often has to create a new one. Always efficient, it recycles the protein by eating the old silk and proposing researchers another mystery to be solved.

### III. Choose the correct option to complete the sentences.

- The secrets of spider silk ....
  - have fabulous properties;
  - haven't been solved yet;
  - are kept well.
- Spider silk has extraordinary properties of being ....
  - fine and invisible;
  - strong and non-resistant;
  - like a trampoline.

- Steel threads are ... spider silk threads.
  - as strong as;
  - much stronger than;
  - far less stronger than.
- The web does not behave like a trampoline because ... .
  - it absorbs the energy of an impact;
  - it can stop a Boeing 747 in full flight;
  - it is made of protein.
- Spider protein consists of ... .
  - dead insects;
  - silk;
  - amino acids.
- The web is a complex structure of nanocrystals combined with \_\_\_\_
  - amino acids;
  - coils;
  - flying objects.
- The function of a disorderly mass of coils is to make the web ... .
  - strong and shiny;
  - absorb the energy of the impact;
  - tangled.
- The spider's ability to produce silk at the temperature of its surroundings and to recycle the web later proves its spinning techniques to be ... .
  - very mysterious;
  - artificial;
  - environmentally friendly.

### IV. Translation Check. Use the dictionary if necessary.

#### Biosilk

The demand for super-strong materials forces scientists to imitate Nature. They found out that biotechnology made synthetic silk protein possible. Research proved that a synthetic gene with the blueprint for a silk protein could be inserted into the genome of a bacterium. The gene of the spider *Nephila clavipes* was used because this silk is unusually strong. It was expected that the bacteria with that gene would make silk protein. The bacteria were reported to be cultured in a fermenter where they grew and multiplied, producing large amounts of silk protein. However, to form a fibre the silk protein had to be dissolved and spun.

As the production of milk and silk are basically similar, there is also the possibility of obtaining silk from transgenic goats. Researchers are known to have recently transferred the synthetic silk-producing gene to the milk-producing cells of a goat. The silk protein dissolved in goat milk is likely to be easier to spin into fibre than that produced by bacteria.

The question is how soon the scientists will invent an efficient method of spinning silk. It was predicted long ago that if biosilk became a reality it would find many uses including bullet-proof vests, commercial fishing nets, tethering satellites. Have you any other ideas?



## TEXT 8

### I. Scan the text to find answers to these questions.

1. When and where was paper invented?
2. How did the invention of paper influence the development of the mankind?
3. Does paper have any advantages over computers?
4. Are there any disadvantages of using paper?
5. What is the objective of creating E-Ink?
6. How does E-Ink beat current display technology?
7. Will environmentalists mind applying E-Ink on a large scale?

### II. Read the text attentively and say what new things you have learnt about E-Ink.

#### E-Ink — A Revolution in Information Technology

With a world full of electronic displays made with liquid crystals, light-emitting diodes and gas plasma, you probably don't think of paper as being a revolutionary display technology, but the Chinese invention of paper in 105 A.D. forever changed the way the world communicates. Without it, books might still be printed on silk rolls, making literacy an expensive skill. It would be nearly impossible to live one day without coming into contact with paper in some form. This year, for example, the world will consume an estimated 280 million tons of paper.

For nearly 2,000 years, ink on paper was the only way to display words and images, and it still beats computer displays when it comes to portability and price. Paper also doesn't require an external power supply. Yet it does have some limitations: once printed on paper, words cannot be changed without at least leaving some marks, and it is also difficult to carry around a large number of books.

Scientists are developing a revolutionary technology that could replace paper, called electronic ink. It will allow you to carry a whole library in one book. E-Ink technology aims at creating a digital book that can type-set itself and that readers could leaf through just as if it were made of regular paper. Such a book could be programmed to alternate between up to 10 books stored on the device. Just as electronic ink could radically change the way we read books, it could change the way you receive your daily newspaper. Simply pressing a button on the delivery computer will simultaneously update thousands of electronic newspapers each morning.

E-Ink has several advantages over current display technology, including: low power usage, flexibility and readability. Electronic

ink uses 50 to 100 times less power than liquid crystal displays because it only needs power when changing the display. E-Ink can be printed on any surface, including walls, product labels and T-shirts. You will soon be able to change your digital wallpaper by sending a signal to the electronic ink painted on the walls. Another advantage electronic ink has over traditional computer displays is its readability. It looks more like printed text, so it's a lot easier on the eyes. And it saves trees by cutting the demand on paper!

### III. Choose the correct option to complete the sentences.

1. The invention of paper changed the world communication by making books ....  
a) expensive; b) available; c) impossible.
2. For nearly 2,000 years words and images were displayed by means of....  
a) ink and paper; b) portable computers; c) books.
3. E-Ink technology will eventually create ....  
a) paper; b) newspapers; c) a digital book.
4. The digital book will look like ... .  
a) a computer display; b) a common book; c) a silk roll.
5. Liquid crystal displays consume ... E-Ink.  
a) more energy than; b) less energy than;  
c) as much energy as.
6. Electronic ink needs power in order to ....  
a) change the display; b) alternate between the books stored;  
c) show pictures.
7. Digital wallpaper, T-shirts and glass prove E-Ink to be ....  
a) energy-efficient; b) readable; c) flexible.
8. Good readability of E-Ink means that the text is ... .  
a) harmless for the eyes; b) easy to understand;  
c) weighs very little.

### IV. Translation Check. Use the dictionary if necessary.

#### How Electronic Ink Will Work

Electronic ink is a new material that will have far-reaching impact on how society receives its information. This patented material is processed into a film for integration into electronic displays. The principal components of electronic ink are millions of tiny microcapsules, about the diameter of a human hair. Each microcapsule contains positively charged white particles and negatively charged black particles suspended in a clear liquid.

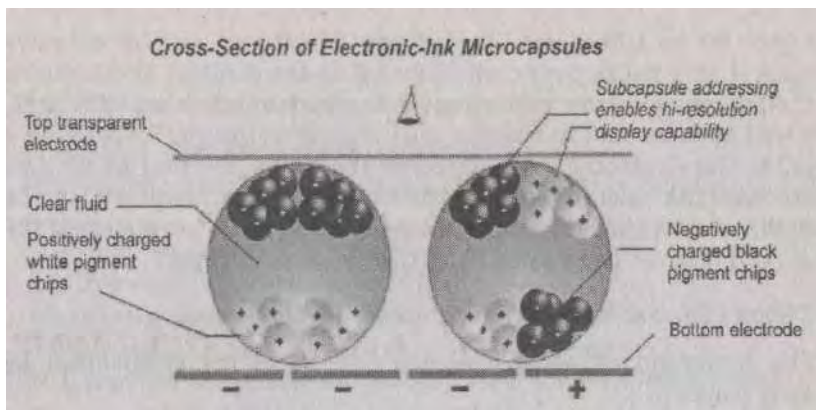

When a negative electric field is applied, the white particles move to the top of the microcapsule where they become visible to the user. This makes the surface appear white at that spot. At the same time, an opposite electric field pulls the black particles to the bottom of the microcapsules where they are hidden. By reversing this process, the black particles appear at the top of the capsule, which now makes the surface appear dark at that spot. To form an E-ink electronic display, the ink is printed onto a sheet of plastic film that is laminated to a layer of circuitry. The circuitry forms a pattern of pixels controlled by a display driver. These microcapsules are suspended in a liquid 'carrier medium' allowing them to be printed onto any surface, including glass, plastic, fabric and even paper. In the long run, electronic ink may have a multibillion-dollar impact on the publishing industry.

### TEXT 9

#### I. Scan the text to find answers to these questions.

1. How many planets of the solar system are invisible to the naked eye?
2. What planets were discovered last?
3. What are the two methods of spotting distant planets today?
4. Are the stars fixed?
5. Why do stars wobble?
6. What is the Doppler effect?
7. What is the problem with the newly-discovered planets?

#### II. Read the text attentively to learn more about space exploration.

## Discovering New Worlds

Nine planets of our solar system orbit round the Sun, six of them being visible to the naked eye. To see the other three (Uranus, Neptune and Pluto) you need a telescope, and you need to know where to point it. The two outermost planets were discovered because of the effect of their gravitational pull on the orbit of Uranus. From the speeding up and slowing down of Uranus, astronomers could work out where the unseen planets were.

Now the gravitational pull of planets on stars has allowed us to find giant planets in orbit around stars far from this solar system. Think about a large planet orbiting close to the star. Both move around, the planet following a large circle, with the star moving in a smaller circle. Both turn around their common centre of gravity. This causes the star to wobble slightly in space. How can this help in spotting a new planet? A distant star is moving towards us for half the time and moving away for the other half. This has an effect on the light we receive from the star. As the star moves towards us, its light waves are compressed, shortening their wavelength so that they look bluer ('blue shift'). As it moves away, its waves are stretched out and look redder ('red shift'). This is the Doppler effect observed for any form of wave. Identifying a star, the frequency of whose light shifts back and forth along the spectrum, first towards blue and then towards red, the scientists interpret this as showing that the star is wobbling in its orbit, as a result of the gravitational pull of a large planet.

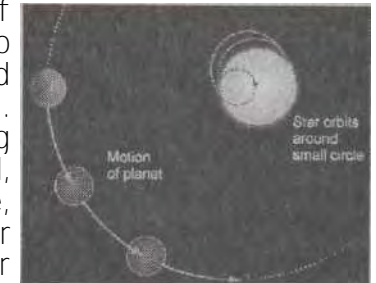

Distant planets are almost impossible to see, as they do not shine by their own light. However, they reflect the light of their star. Moreover, moving around its orbit such a planet will periodically block the star's light giving the scientists more proofs of its own existence.

There is a problem with the newly-discovered planets. They seem to be massive. Their orbiting around the stars at high speed means that they are very close to the stars, and therefore very hot. Our ideas of how planets form do not fit very well with this. Jupiter-sized planets are expected to be gassy giants, far from their stars, where it is cold enough for gases such as carbon dioxide and ammonia to freeze solid. The theorists have some explaining to do.

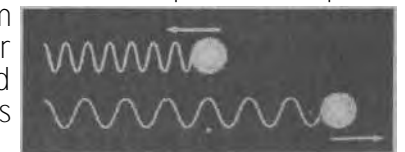

### III. Choose the correct variant to complete the sentences.

1. Six planets of the solar system are visible...  
a) through a telescope; b) without a telescope; c) with a laser.
2. Neptune and Pluto were discovered due to ...  
a) the invention of a telescope; b) their influence on Uranus;  
c) the skill of astronomers.
3. Scientists do not look for ... in order to spot a distant planet.  
a) laser flashes; b) wobbling stars; c) blocked star light.
4. The star being orbited by a large planet is ....  
a) fixed; b) shining brightly; c) wobbling.
5. The 'blue shift' means that the star moves ....  
a) around its gravity center; b) away from us; c) towards us.
6. The pitch of the police siren becoming lower (the sound waves are stretched out) means the police car moving ....  
a) around you; b) away from you; c) towards you.
7. Distant planets are difficult to spot as they do not ...  
a) shine; b) reflect the light of the star;  
c) block the star's light.
8. According to our theories of planet formation giant planets must be....  
a) fast and hot; b) massive and gassy;  
c) cold and far from their star.

### IV. Translation Check. Use the dictionary if necessary.

#### Life Beyond?



Planets beyond the solar system are known as exo-planets. In 1999 British astronomers reported they had detected a reflected light of a giant exo-planet orbiting the star Tau Bootis, 50 light years away, using the William Herschel Telescope in the Canary Islands.

When astronomers look at the light coming from distant exo-planets, they hope to find signs of life. They use a diffraction grating to split the light up into its different wavelengths — in other words they make a spectrum. From this, they can identify the elements present. In the 19th century it was argued that we would never be able to discover what stars are made of. However, examination of the spectra of light from stars soon showed that they were made of the same elements as those on the Earth, mostly hydrogen and helium.

The Earth is different from the other planets in the solar system. Its atmosphere contains oxygen, and that shows up in its spectrum. Oxygen is a sign of life as most plants and animals need it for breathing. But the Earth's atmosphere has not always contained oxygen. It is estimated to have been around only since the first algae produced it by photosynthesis, 2.5 billion years ago. So oxygen isn't simply a sign that life could exist on a distant planet - it is a sign that it almost certainly *does* exist. Astronomers are still looking.

### TEXT 10

#### I. Scan the text to find answers to these questions.

1. How did the universe appear?
2. Why do galaxies move away at practically 90% of the speed of light?
3. What force slows down the acceleration of the galaxies?
4. What is the possible future of the universe?
5. How does the average density of the universe affect its expansion?
6. Has the density of the universe been estimated?
7. Do neutrinos have mass?

#### II. Read the text attentively to learn more about the future of the universe.

### The Universe: Density and Destiny

Scientists suppose that the fate of the universe depends on the average density of the universe. This effect is a consequence of gravity. The universe is believed to have begun 15,000 million years ago with a 'big bang' as a result of which all the matter has kinetic energy and the galaxies are all moving away from one another. But this kinetic energy of expansion struggles against the inward force of gravity attracting galaxies together. Depending on the density of the universe this may result in three options:

- a flat universe (with the critical density of approximately  $10^{-26}$  kg  $m^{-3}$  - of the order of three hydrogen atoms per cubic metre) which will slowly expand forever;

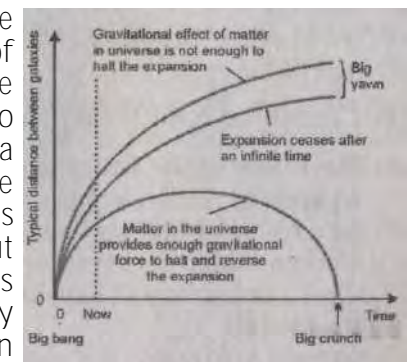

- an open universe (the density is less than critical); it will expand quickly till the galaxies lose contact with each other, stars expire and all activity has ceased;
- a closed universe (with the density greater than critical); it will ultimately contract in a reversal of the 'big bang', called the 'big crunch' which would mean the end of everything - space, time and matter; however, the 'big crunch' may be followed by a new big bang.

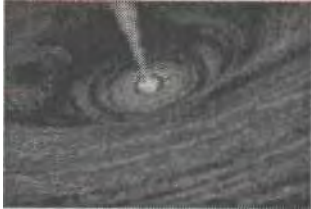

Currently, no one is sure what the density of the universe is. The simplest way to estimate it is to determine the amount of visible matter (stars and gas clouds.). It turns out to be about 1% of the required for critical density and is not nearly enough to pull the flying galaxies back. There is also strong

evidence of the presence of invisible 'dark matter', which, if exists, will account for 10% of the critical density -still too low to explain the motion of stars. The scientists are certain there must be even more matter in the universe. Where is the missing mass? One possible candidate for the missing mass is particles called neutrinos.

Since their discovery in 1933, neutrinos have been believed to have zero mass (like protons). However, a team working at the Super-Kamiokande detector in Japan has proved otherwise. The results of the Super-Kamiokande experiment are much more than simply the means to predict whether a tiny particle has mass. They are a step towards humans being able to predict the ultimate fate of everything.

### III. Choose the correct option to complete the sentences.

1. The future of the universe is affected by its ....  
a) gravity; b) destiny; c) density.
2. As a result of the 'big bang' the universe has been ...  
a) expanding; b) contracting; c) static.
3. The ... universe will expand till it uses up its energy and becomes cold and dead.  
a) flat; b) open; c) closed.
4. A closed universe is expected to result in ...  
a) the 'big bang'; b) the 'big crunch'; c) the 'big flash'.
5. The density of the universe is determined by the amount of ...  
a) visible and dark matter; b) missing mass; c) both.
6. The amount of luminous matter is ... of the critical density.  
a) 1%; b) 10%; c) 11%.

7. The scientists believe that there is more matter in the universe because its estimated density is ...  
a) not exact; b) only 10% of the critical density;  
c) not enough to explain the motion of stars.
8. Neutrinos have proved to have ....  
a) zero mass; b) tiny particles; c) tiny mass.

### IV. Translation Check. Use the dictionary if necessary.

#### Neutrinos

All the matter in the universe is made up of tiny particles, the electron neutrino, the muon neutrino and the tau neutrino being among them. Neutrinos are unlikely to be the dark matter that influences the motion of stars as it is assumed to exist in 'clumps'. Nevertheless, if neutrinos have even a tiny mass, there are enough of them to determine the density and, consequently, the destiny of the universe.

If neutrinos do have mass, it may be possible for them to 'oscillate' into different types of neutrino. Since the 1960s, experiments have proved the number of electron neutrinos reaching the Earth from the Sun to be smaller than expected. This suggests that electron neutrinos oscillate into other types of neutrino during their journey and therefore that they have mass. The scientists could only estimate neutrino masses being around  $2 \times 10^{-38}$  kg (50 million times smaller than the mass of the electron). This tiny mass per neutrino could be very significant considering the number of neutrinos - they are likely to account for much more mass than all the atoms in the universe! If neutrinos do have mass, as the Super-Kamiokande results suggest, a source of the missing mass has been found and the density of the universe must be greater than the observed density required to explain fully the motion of stars.

# ACTIVE VOCABULARY

## Unit 13

### Section A

affect, v **влиять**  
apron, n **фартук**  
arc, n **электрическая дуга**  
attach, v **прикреплять(ся); присоединять(ся)**  
bead, n **сварной шов**  
boot, n **ботинок**  
brush against, v **слегка задевать**  
by means of, **посредством**  
clothing, n **одежда** protecting clothing **защитная спецодежда**  
conventional, adj =ordinary **обычный, общепринятый**  
crack, n **трещина**  
currently, adv **действующий в настоящее время**  
damage, v, n **повреждать; повреждение**  
decade, n **десятилетие**  
desirable, adj **желанный**  
despite, prep **несмотря на**  
drastic, adj **коренной, радикальный**  
effect, n **влияние**  
electrode, n **электрод**  
establish, v **устанавливать**  
exhibit, v **показывать, проявлять**  
follow, v **придерживаться, следовать**  
fuse, v **плавить(ся), сплавлять(ся)**

fusion, n **плавка, слияние**  
glove, n **перчатка**  
helmet, n **шлем, каска**  
hence, prep **следовательно**  
holder, n **ручка, рукоятка**  
join, v **соединять**  
joint, n **стык**  
latter, adj **последний (из двух названных; противополож. the former)**  
location, n **местоположение**  
neither...nor... **ни... ни...**  
nevertheless, cj **тем не менее**  
overall, n **рабочий халат; спецодежда**  
owing to, prep **по причине, вследствие, благодаря**  
penetration, n **глубина проплавления**  
response, n **реакция (на воздействие); срабатывание**  
rod, n **стержень, прут**  
rule, n **правило**  
safe, adj **безопасный** safety rules **правило безопасности**  
significant, adj **значительный, важный, существенный**  
soften, v **размягчать; смягчать**  
strike, v **ударять; зажигать дугу**  
surface, n **поверхность**  
tensile, adj **прочный на разрыв**  
the same, adj **одинаковый**

tip, n **кончик**  
transformer, n **трансформатор**  
unique, adj **единственный в своём роде; уникальный**  
wear, v **быть одетым (во что-л.); носить (одежду и т. п.)**  
weld v, n **сваривать; сварной шов**  
welding, n **сварка**  
widespread, adj **широко распространённый**

### Section B

allow, v **позволять, разрешать**  
block, v **заклинивать(ся), засоряться)**  
both ... and ... **и ... и ...**  
clean, v **чистить**  
coil, n **спираль** coil spring **цилиндрическая (винтовая) пружина**  
condition, n **условие, состояние**  
consequently, adv **следовательно**  
consume, v **потреблять, использовать**  
consumption, n **потребление**  
contract, v **сжиматься**  
convenient, adj **удобный, подходящий; пригодный**  
cool, v **остывать**  
deliver, v **поставлять; доставлять; снабжать**  
ease, v **ослаблять, освобождать, облегчать**  
even, adj **одинаковый; тот же самый**  
exact, adj **точный**  
expand, v **расширять(ся); увеличиваться) в объёме**  
expansion, n **увеличение в объёме, расширение**  
gauge, n **измерительный прибор**

fuel gauge **топливный расходомер**  
fit, v **устанавливать, монтировать**  
function, v, n **действовать; функция**  
immediately, adv **немедленно**  
inside, prep **внутри**  
leading, adj **ведущий; передовой**  
light, n **свет**  
warning light **предупреждающий световой сигнал**  
load, v, n **нагружать, нагрузка**  
means, n **средство, способ** means of transport **средство передвижения**  
overhaul, v, n **ремонтировать; ремонт**  
particle, n **частица** fine particles **мелкие частицы**  
prevent, v **не допускать, препятствовать**  
quantity, n **количество, величина**  
sensitive, adj **чувствительный**  
stress, n **нагрузка**  
supervision, n **наблюдение**  
thermostat, n **термостат**  
wax, n **воск**

## Unit 14

### Section A

abbreviate, v **сокращать**  
alteration, n **изменение**  
bulb, n **лампочка**  
burn out, v **выгорать, перегорать**  
capacitor, n **конденсатор**  
cell, n **батарея, (фотоэлемент)**

fuel cell топливный элемент  
 charged, adj заряженный  
 circuit, n цепь closed circuit  
 замкнутая цепь  
 condenser, n конденсатор  
 core, n стержень, ядро  
 coursework, n курсовая  
 current, n ток direct current  
 прямой ток alternating  
 current переменный ток  
 dielectric, n непроводник  
 electricity, n электричество  
 expect, v предполагать, ожи-  
 дать  
 filament, n нить накала  
 force, v вынуждать  
 frequency, n частота  
 gap, n зазор, промежуток  
 air gap воздушный зазор  
 generate, v вырабатывать, ге-  
 нерировать  
 glow, v гореть, светиться  
 grid, n энергетическая сеть  
 transmission grid сеть  
 электропередач  
 induce, v вызывать  
 insulator, n изолятор, непро-  
 водник  
 loss, n потеря; (мн.) потери  
 mica, n слюда  
 negative, adj отрицательный  
 notice, v замечать  
 notion, n понятие  
 power, n энергия power plant  
 электростанция thermal  
 power термическая энергия  
 nuclear power ядерная  
 энергия underground steam  
 power энергия подземного  
 пара

solar power солнечная энергия  
 kinetic power кинетическая  
 энергия  
 chemical power химическая  
 энергия  
 rectifier, n выпрямитель  
 reverse, v менять направление  
 на противоположное  
 rotate, v вращаться  
 socket, n патрон, розетка stand  
 for, v символизировать,  
 означать  
 supervisor, n научный руково-  
 дитель  
 through, prep через, по  
 transformer, n трансформатор  
 step-up transformer повыша-  
 ющий трансформатор step-down  
 transformer понижающий  
 трансформатор  
 turn, n виток (провода)  
 turn out, v вывёртывать  
 wind, v наматывать  
 winding, n обмотка input winding  
 входная обмотка output winding  
 выходная обмотка  
 primary winding первичная  
 обмотка  
 secondary winding вторичная  
 обмотка  
 wire, n провод  
 overhead conductor wire провод  
 воздушной линии

## Section B

absorb, v поглощать  
 account, n расчет, отчет to take  
 into account принимать во  
 внимание

accumulate, v накапливать  
 array, n панель  
 cell, n элемент photovoltaic cell  
 фотоэлемент  
 circulate, v циркулировать  
 collect, v собирать  
 collector, n коллектор solar  
 collector солнечный  
 коллектор  
 cover, v покрывать  
 divert, v отводить  
 excess, adj излишний  
 exhaust, v истощать  
 fossil, adj ископаемый fossil fuel  
 ископаемое горючее  
 furnace, n печь; топка solar  
 furnace солнечная печь  
 housing, n жилой фонд housing  
 development жилой массив  
 huge, adj огромный  
 inexhaustible, adj неистощимый  
 pollute, v загрязнять  
 pollution, n загрязнение  
 pollution-free, adj экологически  
 чистый  
 run, v работать, действовать,  
 приводить в движение  
 search for, n искать  
 solar-powered, adj приводимый в  
 движение солнечной энергией  
 solution, n решение  
 sunlight, n солнечный свет  
 tackle sth., v пытаться найти  
 решение  
 transfer, v передавать  
 variation, n изменение

## Unit 15

### Section A

constantly, adv постоянно  
 evident, adj очевидный  
 exhaust, v истощать  
 immensely, adv чрезвычайно  
 nearly, adv почти  
 option, n вариант  
 reason, n причина  
 resource, n ресурс renewable  
 resources, *p/* возоб-новляемые  
 ресурсы  
 satisfy, v удовлетворять satisfy  
 needs удовлетворять нужды  
 sensible, adj разумный, ощути-  
 мый  
 shortage, n недостаток, нехватка  
 source, n источник alternative  
 energy sources альтернативные  
 источники энергии  
 threaten, v угрожать  
 time, n раз  
 (...) times as much в (...) раз  
 больше  
 turn into, v превращать  
 twice, adv дважды  
 usable, adj годный к употреб-  
 лению

### Section B

antifreeze, n антифриз  
 backwards, adv назад  
 common, adj обычный  
 coolant, n смазочноохлаждаю-  
 щая эмульсия  
 dirt, n грязь  
 dissipate, v рассеивать

dust, n пыль  
emit, v выбрасывать, выделять  
external, adj внешний  
fault, n ошибка, неисправность  
fill up, v заполнять, наполнять  
flat, adj разряженный flat  
battery разряженная батарея  
fluid, n жидкость . foresee, v  
предсказать, предвидеть  
forwards, adv вперёд; дальше  
gap, n искровой промежуток  
hose, n шланг, гибкий трубо-  
провод  
impurity, n загрязнение,  
грязь  
jam, v заедать, заклини-  
вать(ся)  
mixture, смесь  
fuel mixture топливная смесь  
order, n порядок in order в  
порядке out of order не в  
порядке  
overhaul, n (капитальный) ре-  
монт  
overheat, v перегревать(ся)  
pipe, n труба  
exhaust pipe выхлопная  
труба  
plug, n пробка, заглушка  
spark plug свеча зажигания  
point, n точка  
freezing point температура за-  
мерзания, точка замерзания  
boiling point температура ки-  
пения, точка кипения  
pull, v тянуть  
pump, v подавать насосом, ка-  
чать  
push, v толкать  
release, v освободить, разбло-  
кировать  
ring, n кольцо

piston ring поршневое (уп-  
лотнительное) кольцо  
service, v обслуживать service  
station станция техоб-  
служивания  
start, v заводить, запускать,  
включать, начинать  
starter, n стартер (*устройство  
для пуска двигателя*)  
thorough, adv основательный,  
тщательный  
unobstructed, adj беспрепятст-  
венный, свободный

## Unit 16

### Section A

assure, v обеспечивать  
award, v награждать  
beam, n луч  
reference beam опорный луч  
object beam объектный луч  
coat, v покрывать  
coating, n покрытие, светочув-  
ствительный слой  
colourful, adj красочный, яркий  
dichromatic, adj двухцветный  
direction, n направление  
emboss, v чеканить  
film, n пленка  
foil, n фольга  
hologram, n голограмма  
holography, n голография  
illuminate, v освещать  
image, n образ  
three-dimensional image трёх-  
мерное изображение  
multidimensional image мно-  
гомерное изображение  
imagine, v воображать, пред-  
ставлять

imperfect, adj несовершенный  
indefinitely, adv неограниченно,  
неопределенно  
intend, v предназначать, наме-  
реваться  
interference, n взаимное влияние;  
интерференция interference  
pattern интерференционная  
картина  
lack, v испытывать недостаток,  
нуждаться, не иметь  
lens, n линза, лупа  
master, n мастер-модель, про-  
модель  
mirror, n зеркало  
monochromatic, adj монохромный  
numerous, adj многочисленный  
opposite, adj противоположный  
originally, adj первоначально  
plate, n фотопластин(к)а  
holographic plate голографи-  
ческая пластина  
power, n способность, (оптичес-  
кое) увеличение  
record, v записывать  
reflect, v отражать  
reflection, n отражение  
respectively, adv соответственно  
safelight, n неактивный  
свет, безопасное освещение  
separate, adj отдельный  
single-colour, adj одноцветный  
split, v разбивать  
splitter, n разделитель beam  
splitter, n расщепитель  
электронного луча  
stable, adj устойчивый  
stamp, v отпечатывать, оттис-  
кивать  
the former, the latter, adj пер-вый,  
последний (*из двух*)

vibration, n вибрация, колеба-  
ние  
view, v рассматривать  
viewable, adj наблюдаемый  
visible, adj видимый  
whole, adj =complete целый

### Section B

ability, n способность  
act, v действовать  
additional, adj дополнительный  
approach, v, n приближаться,  
подводить; подход  
artificial, adj искусственный  
conscious, adj сознательный  
control, n управление remote  
control дистанционное  
управление  
count (on), v рассчитывать  
creature, n существо  
definition, n определение  
defuse, v взрывать  
environment, n окружающая  
среда  
eventually, adv со временем  
explore, v исследовать  
gather, v собирать  
imitate, v имитировать  
insert, v вставлять  
intelligence, n разум, интел-  
лект  
linear, adj линейный  
manipulate, v манипулировать  
motor, n двигатель stepper  
motor шаговый (элек-тро)  
двигатель servomotor  
серводвигатель, сервомотор  
navigate, v управлять, направ-  
лять

neural, adj **нейронный** neural network **нейронная сеть**  
qualify, v **определять**  
respond, v **реагировать, срабатывать**  
response, n **реакция (на воздействие), срабатывание (устройства)**  
sense, v **ощущать, чувствовать, понимать**  
solenoid, n **соленоид**  
specific, adj **определенный**  
stimulus, n **сигнал возбуждения, стимул**  
suggest, v **предлагать, советовать**  
supervise, v **контролировать**  
surroundings, n **окружающая среда**  
system, n **система** rule-based system **экспертная система**  
ultrasonic, adj **ультразвуковой**

## Unit 17

### Section A

amplification, n **усиление**  
amplifier, n **усилитель**  
amplify, v **усиливать**  
area, n **область**  
back and forth, adv **назад-вперёд**  
behaviour, n **поведение**  
bounce, v **отскакивать**  
cavity, n **полость**  
coherence, n **когерентность**  
coherent, adj **связанный**  
concave, adj **вогнутый**  
continuous, adj **непрерывный**  
denote, v **означать**  
directionality, n **направленность**

distructon, n **разрушение**  
dozen, n **дюжина**  
excited, adj **возбужденный**  
flash, n **вспышка** flash lamp **импульсная лампа, фотовспышка**  
flat, adj **плоский**  
intense, adj **интенсивный**  
inversion, n **инверсия**  
population inversion **инверсия заселённости (энергетических уровней)**  
majority, n **большинство**  
mean, v **значить**  
medium, n **среда**  
monochromatic, adj **одноцветный, монохроматический**  
oscillator, n **генератор, осциллятор**  
partially, adv **частично**  
pulse, v **пульсировать**  
pulsed, adj **пульсирующий**  
radiate, v **излучать**  
reflective, adj **отражающий**  
resonator, n **резонатор**  
ruby, adj **рубиновый**  
similar to, adj **подобный, похожий**  
totally, adv **полностью**  
transparent, adj **прозрачный**  
treat, v **обращаться**  
unlike, cj **в отличие**  
upper, adj **верхний, высший**  
variety, n **разнообразие** via, prep **через, посредством**  
wavelength, n **длина волны**

### Section B

abundant, adj **изобилующий**  
acid, n **кислота**  
acid rain **кислотный дождь**  
average, adj **средний**

ban, v **запрещать**  
colourless, adj **бесцветный**  
combustible, adj **горючий**  
compound, n **соединение**  
consequences, n **последствия**  
consist in, v **заключаться в**  
densely populated, adj **густонаселенный**  
deplete, v **истощать, разрушать**  
depletion, n **истощение, разрушение**  
destructive, adj **разрушительный**  
dioxide, n **диоксид**  
envelope, n **оболочка**  
eutrophication, n **эвтрофикация (зарастание водоёма водорослями)**  
far-reaching, adj **далеко идущий**  
flammable, adj = inflammable **легко воспламеняющийся, горючий**  
foam, n **пенопласт**  
packaging foam **упаковочный пенопласт**  
gas, n **газ**  
industrial gas **промышленный газ**  
natural gas **природный газ** man-made gas **искусственный газ**  
greenhouse, n **парник, теплица**  
greenhouse effect **парниковый эффект**  
infrared (IR), adj **инфракрасный**  
insist on, v **настаивать**  
layer, n **слой**  
nitrogen, n **азот**  
odourless, adj **без запаха, непахнущий**  
overestimate, v **переоценивать**  
oxygen, n **кислород**

pollutant, n **загрязняющее вещество**  
present, adj **присутствующий**  
react, v **реагировать**  
refrigerant, n **охладитель**  
release, v **высвобождать**  
result in, v **приводить к**  
solvent, n **растворитель**  
state, n **состояние** free state **свободное состояние, несвязанное состояние**  
tasteless, adj **безвкусный**  
toxic, adj **токсичный**  
ultraviolet (UV), adj **ультрафиолетовый**

## Unit 18

### Section A

across, prep **через**  
advanced, adj **развитый**  
alien, adj **внеземной**  
brief, adj **краткий**  
bright, adj **яркий**  
communication, n **связь, коммуникация; система связи**  
compound, adj **составной, сложный**  
detect, v **замечать, находить, обнаруживать**  
distant, adj **удаленный**  
entire, adj **весь**  
establish, v **устанавливать**  
eyepiece, n **глазок**  
fascinating, adj **увлекательный**  
fruitful, adj **плодотворный**  
generate, v **создавать**  
handheld, adj **карманный**  
hardly, adv **едва**  
interstellar, adj **межзвездный**  
item, n **предмет**  
last, v **длиться**



magnification, n **увеличение**  
 magnify, v **увеличивать**  
 maintain, v **утверждать, заявлять**  
 microscopy, n **микроскопия**  
 modify, v **видоизменять**  
 multitude, n **множество**  
 objective, n **объектив**  
 permanent, adj **постоянный**  
 practicable, adj **осуществимый**  
 resolution, n **разрешение**  
 scan, v **наблюдать**  
 sign, n **знак, признак**  
 significantly, adj **значительно**  
 spot, v **находить**  
 star, n **звезда**  
 sodium star **натриевая звезда**  
 X-rays, n **рентгеновские лучи**

### Section B

appealing, adj **привлекательный**  
 booster, n **ракета-носитель**  
 combine, v **сочетать(ся)**  
 disintegrate, v **распадаться**  
 disposable, adj **одноразового использования**  
 essentially, adv **по существу**  
 experience, v **испытывать**  
 gimbal, n **универсальный шарнир**  
 house, v **размещать**  
 initially, adv **сначала, изначально**  
 irreplaceable, adj **незаменимый**  
 land, v **приземляться**  
 launch, v **запускать**  
 lift off, v **взлетать**  
 locate, v **размещать, устанавливать**  
 maneuver, v, n **маневрировать, маневр**

orbiter, n **орбитальная ступень, многоразовый транспортный космический корабль**  
 payload, n **полезный груз**  
 practice, n **практика; применение; осуществление на практике**  
 put into practice **осуществлять**  
 propellant, n **ракетное топливо**  
 rate, n **интенсивность**  
 recoverable, adj **восстановимый**  
 re-entry, n **вхождение в атмосферу**  
 reusable, adj **многоразового пользования**  
 satellite, n **спутник**  
 separate, v, adj **отделять(ся), разделять(ся); отдельный**  
 shuttle, n **многоразовый транспортный космический корабль, МТКК**  
 space, n **космическое пространство, космос**  
 outer space **космическое пространство вне земной атмосферы**  
 spacecraft, n **космический корабль**  
 spaceship, n **космический корабль**  
 storage, n **резервуар, хранение, накопитель**  
 store, v **запасать; накапливать, хранить**  
 take off, v **взлететь**  
 take-off, n **взлет**  
 thrust, n **тяга, сила тяги, (реактивная) сила, толчок**  
 weightless, adj **невесомый**

# GRAMMAR

## Unit 13

The Infinitive is the initial form of the verb. It is usually used with *the particle to*.

	To explain the rule is rather difficult.			
<i>Subject</i>	It <i>is</i> It <i>was</i> It <i>will be</i>	rather quite very	difficult hard necessary essential important easy valuable, etc.	to explain the rule.

<i>Adverbial Modifier of Purpose</i>	To* explain the rule you should give examples. You should give examples in order to explain the rule.
--------------------------------------	--

\* to = in order to (here)

- Consider the difference:
- |  |  |
|--|--|
| 1. To explain the rule is rather difficult.      | 1. <b>Очень тяжело <u>объяснить</u> это правило.</b>                         |
| 2. To explain the rule you should give examples. | 2. <b>Чтобы <u>объяснить</u> это правило, тебе следует привести примеры.</b> |

<i>Predicative</i>	The Its Their Olga's	aim duty idea function goal objective purpose, etc	is was will be	to measure the temperature.
--------------------	-------------------------------	--	----------------------	-----------------------------

<i>Attribute</i>	The car to be used runs on solar power.	1. Машина, которая будет использоваться, работает на солнечной энергии. 2. Машина, которая должна использоваться, работает на солнечной энергии.
------------------	---	---

## Unit 14

*The Complex Object* (the objective infinitive construction) is translated into Russian with the help of an object clause beginning with words **чтобы, что, как**.

<i>subject</i>	<i>predicate</i>	<i>object</i>	<i>(to)* + infinitive</i>
		<i>noun or pronoun in the objective case</i>	
I/you/we/they Students	expect don't expect	me/you/him/her/ us/them the mechanic	to repair the car.
He/she/it Oleg	expects doesn't expect		

\*Remember: to is never used after let, make, see, hear, feel, watch, notice, observe in the Active Voice:

e.g. We watched the engineer make a hologram. Then he let us experiment with a laser.

*The Complex Object* is used after the main verbs denoting:

wish	mental activity	sense perception	awareness	inducement
to want to wish to desire need I would like (=I'd like)	to suppose to expect to consider to assume to prove to believe to understand to know to think to find to understand	to see to hear to feel to watch to notice to observe	to know to find to note to claim to state to declare to pronounce to announce to report	to make to cause to force to let to allow to permit to enable to ask to tell to order to command

We would like you to test the device.

I consider him to be a professional in his field.

She found the carburettor to be blocked.

The engineer told us to stop the experiment.

The teacher makes us study hard.

He heard, the engine start after a loud click.

Мы хотели бы, чтобы вы протестировали этот прибор.

Я считаю, что он профессионал в своей области.

Она обнаружила, что карбюратор засорился.

Инженер сказал нам прекратить эксперимент.

Учитель заставляет нас усердно учиться.

После громкого щелчка он услышал, что двигатель заработал.

Remember: The Infinitive in the Complex Object is often used in the Passive Voice but it is translated into Russian in the Active Voice and is placed before the noun.

The engineer allowed the technology to be used. - Инженер разрешил использовать эту технологию.

*The Complex Subject* (the subjective infinitive construction) is translated into Russian with the help of a non-personal main clause followed by an object clause beginning with the word **что**.

Compare: It is said that the car is broken.

сломана.

Говорят, что машина

The car is said to be broken.

Remember: Always begin translating sentences with the Complex Subject from the predicate rendering it as a non-personal main clause followed by an object clause with the word **что**.

<i>subject</i>	<i>predicate (the expressions, the Passive Voice)</i>		<i>subject (to + infinitive)</i>
I	am (not)	likely supposed	to know Physics well.
You/we/they Students	are (not)		
He/she/it Olga	is (not)		
	<i>predicate (the Active Voice)</i>		to know Physics well.
You/we/they Students	seem don't seem		
He/she/it Olga	seems doesn't seem		

The *Complex Subject* is used with the following:

expressions	verbs in the Passive Voice		verbs in the Active Voice
to be likely to be unlikely to be sure to be certain	to say to know to think to report to suppose to expect	to consider to assume to believe to see to hear, etc. (see <i>Complex Object</i> )	to seem / to appear to prove / to turn out to happen / to occur

The project is likely to be completed soon.

The Sun is considered to provide us with all the energy we need.  
**энергией.**

We happened to work together for the same company.

**Вероятно, что проект скоро завершат.**

**Считается, что Солнце обеспечивает нас всей необходимой**

**Случилось так, что мы работали вместе в одной компании.**

#### Forms of the Infinitive

Aspect / Voice	Active	Passive
<i>Indefinite</i>	He is likely to design a new car soon.	A new car is sure to be designed in the near future.
<i>Continuous</i>	He seems to be designing a new car now.	—
<i>Perfect</i>	He is said to have designed a new car recently.	A new car is reported to have been designed by our engineers.
<i>Perfect Continuous</i>	He proved to have been designing a new car for two years.	—

## Unit 15

The *Participle* is a non-finite form of the verb combining features of the verb, the adjective and the adverb. The two forms of Participles are Participle I and Participle II.

<i>Attribute</i>	<i>PI</i>	We installed a new heating system. <b>Мы установили новую обогревательную систему.</b> We installed a new system heating our house naturally. <b>Мы установили новую систему, обогревающую наш дом природным способом.</b>	<i>Active Voice</i>
		We live in a house being heated naturally at the moment. <b>Мы живем в доме, обогреваемом сейчас природным способом.</b>	
	<i>PII</i>	We live in a solar-heated house. <b>Мы живем в доме, обогреваемом солнечной энергией.</b> We live in the house heated by the Sun all the year round. <b>Мы живем в доме, который обогревается солнцем круглый год.</b>	<i>Passive Voice</i>

<i>Adverbial Modifier</i>	<i>PI</i>	Building solar houses we save energy. <b>Строя дома на солнечных батареях, мы сохраняем энергию.</b> Having built a new solar heating system the engineers started to test it. <b>Построив новую солнечную отопительную систему, инженеры начали ее проверять.</b>	<i>Active Voice</i>
		Being built in a new way the system offers many advantages. <b>Будучи построенной новым способом, эта система имеет множество достоинств.</b> Having been built completely the plant was thoroughly inspected. <b>После того, как завод был полностью построен, его тщательно проверили.</b>	<i>Passive Voice</i>
	<i>PII</i>	When built by skilled workers the experimental system worked well. <b>Построенная опытными рабочими, эта система хорошо работала.</b> If built on time the new power plant will start to work in May. <b>Если новая электростанция будет построена вовремя, она начнет работу в мае.</b>	

## Unit 16

Compare:	<i>Participial Constructions</i>	
	<i>Active Voice</i>	We observed <i>the teacher making</i> a hologram. <b>Мы наблюдали, как учитель делал голограмму.</b>
	<i>Passive Voice</i>	<i>The teacher was observed making</i> a hologram. <b>Наблюдали, как учитель делал голограмму.</b>
	<i>Absolute Participial Constructions</i>	The car <i>having been repaired</i> , the driver left the service station. <b>После того, как починили машину, водитель уехал со станции техобслуживания.</b> An experiment was carried out yesterday, new equipment <i>being used</i> . <b>Вчера был проведён эксперимент, причём использовалось новое оборудование.</b>

The *Gerund* is a non-finite form of the verb combining features of the verb and the noun.

It is used independently and after the following words:

<i>prepositions</i>	<i>nouns+ prepositions</i>	<i>adjectives+ prepositions</i>	<i>verbs</i>
on	the idea of	to be famous for	to mind
after	the method of	to be sorry for	to result in
before	the way of	to be sure of	to object to
without	the purpose of	to be capable of	to use for
instead of	the necessity of	to be tired of	to insist on
against	the technique of	to be good at	to rely on
in spite of,	the importance of,	to be surprised at,	to prevent from,
etc.	etc.	etc.	etc.

*Walking, talking and thinking* like a human being will soon become possible for robots.

Without *gathering* data it is impossible to prove the theory.

The new technique of *compiling* new programmes accelerated our work a lot.

Robots are capable of *doing* difficult tasks.

People cannot prevent robots from *becoming* too clever.

## Unit 17

<i>Forms of the Gerund</i>		
<i>Aspect / Voice</i>	<i>Active</i>	<i>Passive</i>
Indefinite	We are against polluting the air.	We object to the air being polluted.
Perfect	We know of industry having polluted the air badly.	We have had of the air having been polluted badly.

Compare:	<i>Gerund</i>	<i>Participle</i>
	<i>Testing</i> a laser takes time.	<i>Testing</i> a laser he made a discovery.
	Before <i>switching on</i> the laser we read the safety instructions carefully.	<i>Switching on</i> the laser we followed the safety instructions carefully.
	a <i>driving</i> license (= a license for driving)	a <i>driving</i> woman (= a woman that drives)

Compare:	<i>Gerundial Constructions</i>	
	<i>Professor is interested in completing the research.</i>	<i>(he will complete it himself).</i>
	Professor is interested in the <i>research being completed.</i>	(somebody will complete it)
	Professor is interested in <i>students completing</i> the research.	(students will complete it)
	Professor is interested in <i>our completing</i> the research.	(we will complete it)

## Unit 18

### Reported Statements

We use laser telescopes.	He says (that) they use laser telescopes. He said (that) they used laser telescope.	Он говорит, Он сказал,	что они используют лазерные телескопы.
We used laser telescopes long ago.	He says (that) they used laser telescopes long ago. He said (that) they had used laser telescopes long before.	Он говорит, Он сказал,	что они использовали лазерные телескопы уже давно.
We will use laser telescopes soon.	He says (that) they will use laser telescopes soon. He said (that) they would use laser telescopes soon.	Он говорит, Он сказал,	что они скоро будут использовать лазерные телескопы.

Reported statements are introduced by these words: *to say, to report, to announce, to inform, to point out, to consider, to assume, to suppose, to know, to believe, to state, to claim, to suggest, to predict, to think, to be sure, to be certain, to dream, etc.*

### Reported Questions

Are you studying alloys now?	She wonders <u>if</u> we are studying alloys now. She wondered <u>whether</u> we were studying alloys then.
Did you study alloys at the lesson yesterday?	She wonders <u>if</u> we studied alloys at the lesson yesterday. She wondered <u>whether</u> we had studied alloys at the lesson the day before.
Will you study alloys next year?	She wonders <u>if</u> we will study alloys next year. She wondered <u>whether</u> we would study alloys the next year

Remember: if = whether.

<u>What</u> alloys is he studying now?	They ask <u>what</u> alloys he is studying now. They asked <u>what</u> alloys he was studying at that time.
<u>When</u> did he study alloys?	They ask <u>when</u> he studied alloys. They asked <u>when</u> he had studied alloys.
<u>Why</u> will he study alloys in future?	They ask <u>why</u> he will study alloys in future. They asked <u>why</u> , he would study alloys in the future.

Reported questions are introduced by these words: *to ask, to inquire, to question, to wonder, to want to know, to be interested, it is interesting, to know, to find out, not to be sure, etc.*

## Word formation

An English word can be divided into three parts: a prefix, a stem and a suffix. *Pre-* means "before"; a *prefix*, therefore, is what comes before the stem. Prefixes usually change the meaning of the word; for example, *un-* changes a word to the negative. *Unmagnetizable* means 'not capable of being magnetized'. A *suffix* is what is attached to the end of the stem. Suffixes, on the other hand, change the word from one part of speech to another. For example, *ly* added to the adjective *quick* gives the adverb *quickly*. Both prefixes and suffixes are referred to as *affixes*.

PREFIXES +

(STEM) +

SUFFIXES

-ive

Noun-forming suffixes		
SUFFIX	MEANING	EXAMPLES
-ance -ence -er -or	state quality of a person who a thing which	performance  independence programmer, operator compiler, accumulator
-ation -tion	the act of	execution
-ist -yst	a person who	analyst, typist
-ness -ion -ing -ment -ity -ian -ism -dom -ship	condition of action/state activity state, action state, quality pertaining to condition/state domain/condition condition/state	cleanliness conversion welding measurement electricity electrician magnetism freedom relationship, partnership

Verb-forming suffixes		
SUFFIX	MEANING	EXAMPLES
-ize -ate -fy -en	to make	ecomputerize automate, activate simplify harden, widen

Verb-forming suffixes		
SUFFIX	MEANING	EXAMPLES
-ly	in the manner of	electronically, logically

Adjective-forming suffixes		
SUFFIX	MEANING	EXAMPLES
-al -ar -ic -ical	have the quality of	computational, logical circular magnetic, automatic electrical
-able -ible	capable of being	comparable divisible
-ous -ious	capable of being	dangerous religious
-ful -less -ish -ed -ive -ing	characterized by without like having quality of to make or do	helpful careless yellowish computed, punched interactive processing, welding

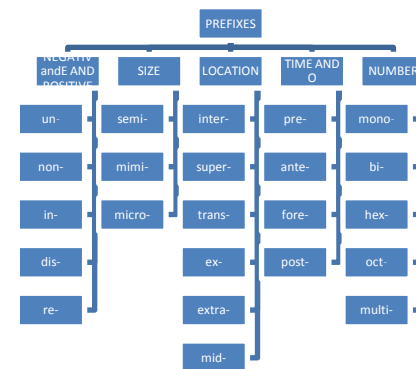

Negative and positive prefixes			
	PREFIX	MEANING	EXAMPLES
Negative	un- in- im- il- ir- non- mis- dis-	not, not good enough  not connected with bad, wrong <ul style="list-style-type: none"> <li>opposite feeling</li> <li>opposite action</li> </ul>	unmagnetized, unpunched incomplete impossible illegal irregular, irrelevant non-programmable, non-impact mispronounce disagree discount
	anti- de- under-	against reduce, reverse too little	antisocial demagnetize, decode underestimate
Positive	re- over	do again too much	rearrange overheat
Prefixes of size			
	PREFIX	MEANING	EXAMPLES
	semi- equi- maxi- micro- mini- macro- mega- }	half, partly equal big small little  large	semiconductor equidistant maxicomputer microcomputer minicomputer macroeconomics megabyte
Prefixes of location			
	PREFIX	MEANING	EXAMPLES
	inter- super- trans- ex- .. extra- sub- infra- peri-	between, among over across out beyond under below around	interface, interactive supersonic transmit, transfer exclude, extrinsic extraordinary subscheme infra-red peripheral

Prefixes of time and order		
PREFIX	MEANING	EXAMPLES
ante- pre- }	before	antecedent prefix
prime - post- retro-	first after backward	primary, primitive postdated retroactive

Prefixes of numbers		
PREFIX	MEANING	EXAMPLES
semi- mono- bi- tri- quad- penta- hex- septi- oct- dec- multi-	half one two three four five six seven eight ten many	semicircle monochromatic binary triangle quadrangle pentagon hexagon septivalent octagon decimal multiprogramming

Other prefixes		
PREFIX	MEANING	EXAMPLES
auto- co- neo- pan-	self together new all	automatic coordinate neoclassical panchomatic

## Список наиболее употребительных предлогов и совпадающих с ними по форме союзов и наречий

about	о, про, относительно около, примерно, вокруг
above	выше, над
above all	прежде всего
across	поперек, через, на другой стороне
after	после; за; после того как ( <i>союз</i> )
after all	в конце концов
against	против
along	вдоль, по
among	среди
around (round)	вокруг
at	<i>при обозначении места:</i> в, на, у; <i>при обозначении времени:</i> в; <i>при обозначении занятия:</i> за
at last	наконец
at least	по крайней мере
before	<i>при обеспечении места:</i> перед; <i>при обозначении времени:</i> до, перед; раньше ( <i>наречие</i> ); прежде чем ( <i>союз</i> ), до того как, перед тем, как
behind	позади, за
below	ниже, внизу
beside	рядом с
besides	помимо, кроме
between	между
by	<i>эквивалент русск. творит. падежа имени существительного:</i> посредством, путем; мимо; к ( <i>о времени</i> )
by the way	кстати, между прочим
by no means	никоим образом
down	вниз по; ВНИЗ ( <i>наречие</i> )
for	за, ради; для; в течение ( <i>указывает длительность</i> ); ибо, так как ( <i>союз</i> )
from	из, с, у; от
in	в; через ( <i>для обозначения времени</i> )
in this way	таким образом
into	в ( <i>на вопрос «куда?»</i> )
of	<i>эквивалент русск. родит. падежа имени существительного:</i> из, о, про
of course	конечно

on=upon	на; по; о; <i>для обозначения времени; с днями и числами:</i> вперед, дальше
over	через (над); свыше
since	с, с момента; с тех пор как; поскольку; так как
through	через (внутри, по)
throughout	по всему, во всем
till=until	до; (до тех пор) пока ... не
to	<i>эквивалент русск. дат. падежа имени существительного;</i> к. в. на ( <i>движение в направлении к чему-то</i> )
toward (towards)	к; по направлению к
under	под; при; по, согласно
until	<i>см. till</i>
up	вверх по; вверх ( <i>наречие</i> )
up to	вплоть до
upon	<i>см. on</i>
with	<i>эквивалент русск. творит. падежа имени существительного;</i> с, со
within	в пределах; через ( <i>о времени</i> )
without	без



## List of irregular verbs

Infinitive	Past Simple	Past participle	Infinitive	Past Simple	Past participle
be	was/were	been	give	gave	given
beat	beat	beaten	go	went	gone
become	became	become	grow	grew	grown
begin	began	begun	hang	hung	hung
bend	bent	bent	have	had	had
bet	bet	bet	hear	heard	heard
bite	bit	biten	hide	hid	hidden
blow	blew	blown	hit	hit	hit
break	broke	broken	hold	held	held
bring	brought	brought	hurt	hurt	hurt
build	built	built	keep	kept	kept
burst	burst	burst	know	knew	known
buy	bought	bought	lay	laid	laid
catch	caught	caught	lead	led	led
choose	chose	chosen	leave	left	left
come	came	come	lend	lent	lent
cost	cost	cost	let	let	let
cut	cut	cut	lie	lay	lain
deal	dealt	dealt	light	lit	lit
dig	dug	dug	lose	lost	lost
do	did	done	make	made	made
draw	drew	drawn	mean	meant	meant
drink	drank	drunk	meet	met	met
drive	drove	driven	pay	paid	paid
eat	ate	eaten	put	put	put
fall	fell	fallen	read/ri:d/	read/red/	read/red/
feed	fed	fed	ride	rode	ridden
feel	felt	felt	ring	rang	rung
fight	fought	fought	rise	rose	risen
find	found	found	run	ran	run
fly	flew	flown	say	said	said
forbid	forbade	forbidden	see	saw	seen
forget	forgot	forgotten	seek	sought	sought
forgive	forgave	forgiven	sell	sold	sold
freeze	froze	frozen	send	sent	sent
get	got	got	set	set	set

Infinitive	Past Simple	Past participle	Infinitive	Past Simple	Past participle
sew	sewed	sewn/sewed	sting	stung	stung
shake	shook	shaken	stink	stank	stunk
shine	shone	shone	strike	struck	struck
shoot	shot	shot	swear	swore	sworn
show	showed	shown	sweep	swept	swept
shrink	shrank	shrunk	swim	swam	swum
shut	shut	shut	swing	swung	swung
sing	sang	sung	take	took	taken
sink	sank	sunk	teach	taught	taught
sit	sat	sat	tear	tore	torn
sleep	slept	slept	tell	told	told
speak	spoke	spoken	think	thought	thought
spend	spent	spent	throw	threw	thrown
split	split	split	understand	understood	understood
spread	spread	spread	wake	woke	woken
spring	sprang	sprung	wear	wore	worn
stand	stood	stood	win	won	won
steal	stole	stolen	wind	wound	wound
stick	stuck	stuck	write	wrote	written

## Key to the crosswords

### Unit 13 Section A

*Down:*

- |             |           |
|-------------|-----------|
| 1. plate    | 7. beam   |
| 2. defect   | 8. bead   |
| 3. create   | 9. strong |
| 4. deform   | 10. crack |
| 5. joint    | 11. weld  |
| 6. property |           |

*Across:*

1. performance

### Unit 14 Section A

*Down:*

- |             |             |
|-------------|-------------|
| 1. transmit | 6. turn     |
| 2. flow     | 7. primary  |
| 3. rectify  | 8. magnet   |
| 4. open     | 9. glow     |
| 5. direct   | 10. circuit |

*Across:*

11. alternator

### Unit 15 Section B

*Down:*

- |                |             |
|----------------|-------------|
| 1. fan         | 7. spark    |
| 2. common      | 8. brake    |
| 3. charge      | 9. petrol   |
| 4. carburettor | 10. horn    |
| 5. fuel        | 11. service |
| 6. empty       |             |

*Across:*

12. accelerator

### Unit 16 Section A

*Across:*

- |               |                |
|---------------|----------------|
| 1. viewer     | 6. coating     |
| 2. vibrate    | 7. application |
| 3. whole      | 8. recorder    |
| 4. visibility | 9. original    |
| 5. consumer   |                |

*Down:*

1. evolution

### Unit 17 Section A

*Across:*

1. distance

*Down:*

- |             |               |
|-------------|---------------|
| 2. solid    | 6. oscillator |
| 3. cavity   | 7. concave    |
| 4. pulsed   | 8. excite     |
| 5. particle | 9. reflect    |

### Unit 11 Section B

*Down:*

1. chlorofluorocarbon  
14. carbon

*Across:*

- |             |              |
|-------------|--------------|
| 2. acid     | 8. difficult |
| 3. heat     | 9. pollutant |
| 4. slow     | 10. unite    |
| 5. robotics | 11. modern   |
| 6. property | 12. argon    |
| 7. object   | 13. oxide    |

### Unit 18 Section A

*Across:*

1. constellation

*Down:*

- |                |              |
|----------------|--------------|
| 1. computer    | 8. flash     |
| 2. powerful    | 9. handheld  |
| 3. scanner     | 10. optics   |
| 4. observatory | 11. eyepiece |
| 5. limited     | 12. recorder |
| 6. decode      | 13. distant  |
| 7. alien       |              |

# CONTENTS

Unit Thirteen. Mechanical Technology .....	4	Language Practice .....	51	Further Reading .....	102	Check Your Progress.....	143
<i>Section A. Welding</i> .....	4	Reading and Speaking.....	55	Activity.....	105	Supplementary Reading ...	152
Lead-in.....	4	Further Reading.....	58	Writing.....	105	Text1 .....	152
Language Practice .....	5	Activity.....	60	<i>Section B. Industrial Gases</i> ..	106	Text 2.....	154
Reading and Speaking .....	9	Writing.....	60	Lead-in.....	106	Text3 .....	157
Further Reading .....	11	<i>Section B. Automotive Problems</i> .....	61	Language Practice .....	108	Text 4 .....	159
Activity .....	13	Lead-in .....	61	Reading and Speaking .....	<b>111</b>	Text 5 .....	162
Writing .....	15	Language Practice .....	63	Further Reading .....	113	Text 6 .....	164
<i>Section B. Mechanisms</i> .....	16	Reading and Speaking.....	66	Activity.....	116	Text 7 .....	167
Lead-in .....	16	Further Reading.....	68	Writing.....	117	Text 8 .....	170
Language Practice .....	18	Activity.....	70	Unit Eighteen. Scientific Exploration .....	119	Text 9 .....	172
Reading and Speaking .....	21	Writing.....	72	<i>Section A. Optical devices</i> ...	119	Text 10.....	175
Further Reading .....	23	Unit Sixteen. Advances in Technology .....	73	Lead-in.....	119	Active Vocabulary.....	178
Activity .....	25	<i>Section A. Holograms</i> .....	73	Language Practice.....	120	Unit 13 (178) Unit 14 (179)	
Writing .....	26	Lead-in .....	73	Reading and Speaking .....	123	Unit 15 (181) Unit 16 (182)	
Unit Fourteen. Electricity . . .	28	Language Practice .....	74	Further Reading .....	126	Unit 17 (184) Unit 18 (185)	
<i>Section A. Electricity Basics</i> . .	28	Reading and Speaking.....	77	Activity.....	128	Grammar.....	187
Lead-in .....	28	Further Reading.....	79	Writing.....	129	Unit 13 (187) Unit 14 (188)	
Language Practice .....	29	Activity.....	81	<i>Section B. Space Shuttles</i> . . .	130	Unit 15 (190) Unit 16 (191)	
Reading and Speaking .....	33	Writing.....	82	Lead-in .....	130	Unit 17 (192) Unit 18 (194)	
Further Reading .....	35	<i>Section B. The Age of Robots</i> . .	83	Language Practice .....	131	Word formation .....	195
Activity .....	37	Lead-in .....	83	Reading and Speaking.....	135	<b>Список предлогов, союзов и наречий</b> .....	200
Writing .....	38	Language Practice .....	85	Further Reading .....	138	List of irregular verbs .....	202
<i>Section B. Solar Energy</i> .....	39	Reading and Speaking .....	88	Activity.....	141	Keys to the crosswords .....	204
Lead-in .....	39	Further Reading.....	90	Writing.....	141		
Language Practice .....	41	Activity.....	93				
Reading and Speaking .....	44	Writing.....	93				
Further Reading .....	46	Unit Seventeen. Dangers of New Technologies.....	95				
Activity .....	48	<i>Section A. Laser</i> .....	95				
Writing .....	49	Lead-in.....	95				
Unit Fifteen. Engineering Problems .....	50	Language Practice .....	96				
<i>Section A. Energy Problems</i> . .	50	Reading and Speaking .....	99				
Lead-in .....	50						

**Хоменко** Светлана Анатольевна  
**Скалабан** Валентина Филипповна  
**Крупеникова** Алеся Георгиевна  
**Ушакова** Елена Владимировна

**АНГЛИЙСКИЙ ЯЗЫК ДЛЯ СТУДЕНТОВ  
ТЕХНИЧЕСКИХ ВУЗОВ:  
ОСНОВНОЙ КУРС**

**В 2 частях**

**Часть 2**

Учебное пособие

Редактор *Л. Д. Касьянова*  
Художественный редактор *Е. Э. Азунович*  
Технический редактор *Н. А. Лебедевич*  
Компьютерная верстка *И. С. Оликсевич*

Подписано в печать 22.03.2004. Формат 60 × 90/16. Бумага газетная. Гарнитура «Школьная».  
Офсетная печать. Усл. печ. л. 13,0. Уч.-изд. л. 11,7. Тираж 4000 экз. Заказ 876.

Республиканское унитарное предприятие «Издательство "Вышэйшая школа"». Лицензия  
№ 02330/0056829 от 02.03.2004. 220048, Минск, проспект Машерова, 11.

Открытое акционерное общество «Полиграфический комбинат имени Я. Коласа». 220600, Минск,  
ул. Красная, 23.

Министерство образования Республики Беларусь  
Белорусский национальный технический университет  
Кафедра английского языка №1

Ваник И.Ю.  
Ляхевич Е.Г.  
Лапко О.А.  
Сурунтович Н.В.

**Методическое пособие  
по обучению устной речи для студентов  
технических вузов**

Минск 2012

УДК 811.111-028.16(075.8)

ББК 81.2Англ.я7.

М54

### **Рецензенты:**

доцент кафедры английского языка экономических специальностей факультета международных отношений БГУ, кандидат педагогических наук, доцент О.И.Моисеенко;

доцент кафедры речеведения и теории коммуникации УО «Минский государственный лингвистический университет», кандидат филологических наук, доцент Т.А. Сысоева

### **Ваник И.Ю.**

Методическое пособие по обучению устной речи для студентов технических вузов / И.Ю. Ваник, Е.Г. Ляхевич, О.А. Лапко, Н.В. Сурунтович. – Мн.: БНТУ, 2012. – 66 с.

Настоящее методическое пособие предназначено для студентов I и II курсов технических специальностей. Пособие состоит из шести разделов, каждый из которых включает аутентичный текстовый материал, а также комплекс упражнений, направленных на развитие навыков монологической и диалогической речи в ситуациях социально обусловленного и профессионально ориентированного общения.

УДК 811.111-028.16(075.8)

ББК 81.2Англ.я7

М54

© Ваник И.Ю., Ляхевич Е.Г.,  
Лапко О.А., Сурунтович Н.В., 2012  
© БНТУ, 2012

*Unit 1*  
*Higher Engineering Education in Belarus*

STARTING UP

Exercise 1.

Are you sure that engineering is the right course of study for you? Go through the list of points to decide whether to study engineering. Choose the statements which refer to you.

1. I enjoy practical projects – creating and investigating things.
2. I like finding out how things work.
3. **I'm interested in improving the environment.**
4. I enjoy solving problems.
5. I enjoy organizing activities.
6. I enjoy science programmes on TV.
7. I sometimes read articles on scientific or engineering topics.

If you have chosen most of these activities, engineering is the suitable course of study for you.

Exercise 2.

Study the meanings of the word **'engineering' in Russian. Then** translate the phrases below.

*Engineering* – 1. инженерное дело 2. техника 3. технология 4. строительство 5. разработка, проектирование, конструирование 6. технический, инженерный, конструкционный.

Engineering education, engineering materials, production engineering, engineering students, electrical engineering, power engineering, highway engineering, mechanical engineering, environmental engineering, electronic engineering, military engineering, civil engineering, nuclear engineering, mining engineering, software engineering.

Exercise 3.

Match the branch of engineering to the products it deals with.

Use the model: *Mechanical engineering deals (is concerned) with machines.*

Branch of engineering	Products of the branch
1. automobile	a. roads and bridges
2. electrical	b. ships and boats
3. civil	c. excavators and loaders
4. medical	d. planes and helicopters
5. electronic	e. cars and trucks
6. marine	f. X-ray machines and body scanners
7. aeronautical	g. electricity generation and electrical installation
8. mining	h. computers and satellite communications

## VOCABULARY

### Exercise 1.

Match the English words (phrases) with their Russian equivalents.

1. environmentally friendly	a. студент
2. to apply	b. система зачетов
3. supervisor	c. идти на работу, службу
4. full-time	d. заочное обучение
5. undergraduate	e. производственная практика
6. to look for solutions	f. научный руководитель
7. curriculum (curricula – pl.)	g. оценивать
8. part-time	h. потребность непрерывного обучения
9. postgraduate	i. дневное обучение
10. pass-fail system	j. искать решения
11. academic guidance	k. экологически чистый
12. industrial placement	l. учебный план
13. hall of residence	m. применять
14. a habit of lifelong learning	n. магистрант, аспирант
15. to assess	o. наниматель
16. to go into employment	p. учебное руководство
17. scholarship	q. приносить пользу
18. graduate thesis (theses – pl.)	r. исследование
19. employer	s. жилье, проживание
20. to benefit	t. дипломная работа, диссертация
21. accommodation	u. стипендия
22. research	v. общежитие



### Exercise 2.

Match the words to their definitions. Check any unknown words in a dictionary.

Scholarship, university, lecture, term, a graduate, curriculum, skill, research, placement

- a. a long talk on a particular subject that someone gives to a group of people, especially to students in a university
- b. the things that are studied in a particular subject
- c. an ability to do something well, especially because you have learned and practiced it
- d. serious study of a subject, in order to discover new facts or test new ideas
- e. an amount of money that is given to someone by an educational organization
- f. a job, usually as a part of a course of study, which gives you experience of a particular type of work
- g. an educational institution of the highest level
- h. one of the two periods of time that university year is divided into
- i. someone who has completed a university degree

### Exercise 3.

Match the words with a similar meaning. Check any unknown words in a dictionary.

1. undergraduate	a. teaching staff
2. research	b. pollution-free
3. term	c. to perform
4. thesis	d. student
5. to integrate	e. vital
6. academic staff	f. investigation
7. outlook	g. field of study
8. essential	h. characteristic
9. to undertake	i. view
10. environmentally friendly	j. demand
11. feature	k. dissertation
12. need	l. to combine
13. subject area	m. semester

#### Exercise 4.

Here is an extract from a speech made by a career advisor to a group of students choosing their future courses of study at university. Complete the speech by choosing one of the words from the box.

Develop, chemical, civil, highway, production, physics, electrical, mechanical, electronic

Engineering students should have **an understanding of maths**, ... and chemistry. Working with pharmaceuticals, food, mineral processing and **chemical manufacturing**, a ... **engineer is trained to understand, design**, control, and investigate materials flows. If you enjoy problem solving and find projects such as the National Library and Minsk Arena interesting, ... **engineering may be for you**. If your interest is in road building then you may follow a specialized course in ... **engineering**. By studying ... and ... **engineering** you learn about the design of complete systems, such as **computers, controllers, power and transport systems**. ... **engineers plan, design and** ... a wide range of things: washing machines, cars and spacecraft. ... **engineers work very closely with mechanical engineers**, to make new products at the right price, on time and in the correct quantity.

#### READING

##### Exercise 1.

Read the text carefully. Then discuss the questions below.

1. What products of engineers can you name?
2. What solutions are engineers constantly looking for?
3. What higher engineering institutions do you know in Belarus?
4. What fields of engineering is specialist training provided in?
5. Is engineering and technology education available on full-time or part-time basis?
6. What does the undergraduate curriculum of each engineering institution include?
7. What academic activities allow students to get theoretical and practical knowledge?
8. What is the key feature of all engineering and technology courses?
9. What investigative project do all students undertake in the final year?

10. Why is the habit of lifelong learning essential for students?
11. How long does it take to complete an engineering course at university?
12. What opportunities do students have after graduation?
13. What are postgraduate students engaged in?
14. Why do Belarusian universities continually revise their curricula?

### *Higher Engineering Education in Belarus*

Engineering is an essential part of everyday life. The products of engineers are all around us – computers, cars, aircraft, roads, bridges, medical equipment and much more. Engineers are constantly looking for solutions that are faster, safer, stronger, more efficient, more environmentally friendly and more economical.

The education system of any country is responsible for producing new generations of engineers capable of applying scientific knowledge and practical experience to produce things that benefit people. Higher engineering education in Belarus is provided by a number of universities, including the Belarusian National Technical University, the Belarusian State University of Informatics and Radioelectronics, the Belarusian State Technological University, the Belarusian State University of Transport, Brest State Technical University and others. The universities offer specialist training in a wide range of fields – electronic and electrical engineering, mechanical, civil and nuclear engineering, chemical and environmental engineering and so on.

Engineering and technology education is offered on full-time and part-time basis. The undergraduate curriculum of each institution integrates fundamentals of natural sciences, engineering science and mathematics with engineering practice aspects. Lectures, seminars, practical and laboratory classes allow students to get scientific knowledge and practical skills in different subject areas. The teaching staff provide students with academic guidance and help to form a professional outlook.

An academic year begins in autumn and is divided into two terms. Students are assessed at the end of each term through a pass-fail system and examinations. Individual project work or a coursework in a particular subject area is also a key feature of all engineering and technology courses. In the final year considerable emphasis is placed on a major investigative project, a graduate thesis, undertaken by all students. As all

engineering and technology courses are industry oriented, students are regularly sent out on an industrial placement for training.

It is essential that students are taught a habit of lifelong learning to function productively as professional engineers over the full course of their careers. Belarusian universities offer a wide range of scholarships, summer placements, and employment opportunities. Standard university accommodation in the halls of residence is also available for many undergraduates.

Students normally graduate after 4 or 5 years with the Diploma of **Higher Education. However, today's employers want more than a diploma holder** – they want graduates who have developed a range of skills and qualities appropriate for modern industry. After graduation students **may go directly into employment or join one year Master's programme.** This is an important step for a career in research.

All universities in Belarus are research-based institutions and offer a wide range of postgraduate degree programmes. Postgraduate students undertake significant research working closely with a supervisor from the academic staff. By the end of the course they produce a thesis that makes an original contribution to knowledge.

As the needs of industry change Belarusian universities continually revise their curricula to reflect both the latest developments in engineering education and in technology.

## SKILLS

### Exercise 1.

Match the first part of the sentence (1-6) with the second part (a-f).

1. Higher engineering institutions offer a number of academic activities, including	a. a vital component of every student's professional development
2. Well-qualified and cooperative teaching staff	b. a graduate thesis, undertaken by all students
3. Industrial training and experience are	c. the ability to apply theoretical knowledge to real industrial problems
4. In the final year considerable emphasis is placed on	d. lectures, seminars, practical and laboratory classes in different subject areas

5. <b>Today's employers</b> value the graduates who have	e. to continuously improve their knowledge and competence
6. A habit of life long learning is essential for practicing engineers	f. provide students with academic support

Exercise 2.

Play a game with the class. One person thinks of a job from the list (*architect, truck driver, miner, electrician, software engineer, biologist, civil engineer*). Other students have to find out what the job is. They can only ask questions where the answer is *yes* or *no*.

Example:

1. Do you travel a lot?
2. Do you use a computer?
3. Do you need qualifications to do your job?
4. Do you need to wear special clothing?
5. Do you have to think a lot?
6. Do you work night shifts?
7. Do you work outside?
8. Do you work long hours?
9. Do you meet a lot of different people?
10. Do you have much responsibility?

**Are you a ... ?**

Exercise 3.

Work in pairs to discuss higher engineering education in Belarus. Put the words in the questions in the correct order and complete the dialogue below.

A: Engineering education is quite popular with young people in our country. Do you know, universities / engineering / what / provide / education / in Belarus?

**B: If I'm not mistaken, these are ...**

A: **different fields / is separated / engineering / in a number of / isn't it?**

**B: Actually, you can study ...**

A: engineering / available / basis / higher / only on full-time / education / is?

**B: Not really, ...**

A: disciplines / study / do / what / engineering students?

**B: As I know, ...**

A: students / project / do / undertake / work?

**B: Certainly, ...**

A: do / where / practical / gain / engineering students / experience?

**B: You know, they ...**

A: last / how / does / universities / an engineering course / long / in the Belarusian?

**B: If I remember right, ...**

A: opportunities / do / have / what / students / after graduation?

**B: I think, ...**

A: I see. Thanks. Now I'm clear about engineering education in Belarus.

**B: It's OK.**

Exercise 4. Translate the sentences below into English.

1. Одной из основных задач преподавателей университета является оказать поддержку студентам в развитии их личностных и профессиональных навыков.

2. В Республике Беларусь активно развивается атомная энергетика. Ряд высших технических учебных заведений нашей страны обеспечивают подготовку инженеров в этой области.

3. Преподаватели университета руководят учебной работой студентов и консультируют их при подготовке курсовых и дипломных работ.

4. Производственная практика приносит пользу будущим инженерам, так как они учатся применять полученные теоретические знания на практике.

5. Студентам дневного отделения предоставляется жильё в университетских общежитиях, расположенных недалеко от студенческого городка.

6. Преподаватели университета оценивают знания студентов очной и заочной форм обучения по системе зачетов и экзаменов в конце каждого семестра.

7. Сегодня работодатели нанимают на работу не просто дипломированных специалистов, а молодых людей, обладающих рядом навыков, необходимых для работы в различных отраслях современной промышленности.

8. Многие выпускники продолжают обучение по магистерской программе, которая является важной ступенью в их исследовательской карьере.

9. По окончании курса магистратуры студенты-магистранты представляют свои диссертационные исследования, которые определенно вносят вклад в научное знание.

*UNIT 2*  
*Higher Education in Great Britain*

STARTING UP

Exercise 1.

Discuss the following questions:

1. If you had a chance to get higher education abroad, what country would you choose? Why?
2. Do you agree that the UK enjoys the reputation of a world leader in education?
3. What world famous British universities do you know?

Exercise 2.

Look through the list of the reasons to get higher education in Great Britain. Rank them in order of their importance. Explain your choice.

1. World reputation for high quality education
2. State-of-the-art study and research facilities
3. New educational experience
4. A good way of improving your knowledge of English
5. The opportunity to study alongside world-class teachers
6. Great employment opportunities worldwide

VOCABULARY

Exercise 1.

Match the English words (phrases) with their Russian equivalents.

1. admission	a. изучать, рассматривать
2. self-governing	b. практикум
3. tutorial	c. поддержка

4. assessment	d. индивидуальное обучение
5. medieval	e. прием в университет
6. to suit	f. назначать
7. to clarify	g. университетский городок
8. bachelor	h. автономный
9. to appoint	i. иметь много общего
10. to place emphasis on smth.	j. гуманитарные предметы
11. punting	k. средневековый
12. support	l. развлекательные мероприятия
13. practical	m. оценка
14. personal tuition	n. практическое занятие с преподавателем-консультантом
15. antiquity	p. происхождение
16. to explore	q. подходить, устраивать
17. arts subjects	r. катание на лодке с шестом
18. recreational activities	s. самостоятельно
19. to have a great deal in common	t. прояснять
20. origin	u. древность
21. independently	v. бакалавр
22. campus	w. придавать значение чему-либо

### Exercise 2.

Match the English words (phrases) with their definitions. Check any unknown words in a dictionary.

Admission, tutorial, multimedia, degree, assessment, accommodation, content, origin
---

- a. involving computer programmes that use a mixture of sound,
- b. pictures, video, and writing to give information
- c. a place for someone to live or stay
- d. the evaluation or estimation of the nature, quality, or ability of someone or something
- e. the process of allowing people to enter a university, institution
- f. ideas, facts, or opinions that are contained in a speech, piece of writing, film, programme.
- g. an academic rank conferred by a university after examination or after completion of a course



- h. the place or situation in which something begins to exist
- i. a regular meeting between a tutor and one or several students, for discussion of a subject that is being studied

Exercise 3.

Match the words with a similar meaning. Check any unknown words in a dictionary.

1. to found	a. dormitory
2. recreation	b. outstanding
3. hall of residence	c. to supply
4. rapid	d. range
5. prominent	e. to allow
6. to provide	f. autonomous
7. suitable	g. to set up
8. variety	h. without assistance
9. self-governing	i. to be situated
10. to enable	j. entertainment
11. independently	k. appropriate
12. to be located	l. fast

Exercise 4.

Match the words that go together. Check that you know the meanings of the phrases. Then complete the sentences below.

1. to place	a. activities
2. tutorial	b. learning
3. recreational	c. university
4. <b>Master's</b>	d. great emphasis
5. distance	e. technology
6. halls of	f. practicals
7. campus-based	g. politicians
8. laboratory	h. system
9. information	i. residence
10. prominent	j. degree

1. Margaret Thatcher, Indira Gandhi, Bill Clinton and many other ... **studied at Oxbridge.**

2. Good standard accommodation is available to all first-year students in the University ... .

3. ... allow students to get practical experience applying material from their lectures.

4. **The University provides ... for every interest one could imagine.**

5. **The big advantage of living in a ... is that the majority of your needs are situated on one site.**

6. **Oxbridge... on personal tuition which provides students with the opportunity to get in-depth knowledge in their chosen subject.**

7. **...is a method of studying in which** students are provided with interactive teaching and multimedia materials.

8. At Oxford and Cambridge teaching is conducted primarily through the ....

9. Last year she completed a four-year course in economics to get a ....

10. **With the help of ... it is easy to provide audio visual education.**

## READING

### Exercise 1.

What facts do you know about higher education in Great Britain? Do the general knowledge quiz below and then check your answers by reading the text.

### General Knowledge Quiz

- 1) Which is the largest university in the country?
  - a) Oxford University
  - b) London University
  - c) Bristol University
- 2) When were the first British Universities set up?
  - a) In medieval times
  - b) In the 19<sup>th</sup> century
  - c) In the 20<sup>th</sup> century
- 3) Which Universities are the oldest ones?
  - a) Oxford and Cambridge Universities
  - b) Glasgow and London Universities
  - c) Edinburgh and Manchester Universities
- 4) How many terms is the academic year divided into?
  - a) Two terms
  - b) Three terms
  - c) Four terms

- 5) Which University provides degrees only by distance learning?
  - a) Cambridge University
  - b) Bristol University
  - c) Open University
- 6) How long do most courses last?
  - a) Three or four years
  - b) Five years
  - c) Six years

### *Higher Education in Great Britain*

Higher education in Great Britain is mostly provided by the Universities. At present there are more than 100 universities in Britain. All British universities are private institutions and enjoy complete academic freedom, appointing their own staff and deciding which students to admit. The admission to the universities is by examinations and interviews. The universities determine the length and the content of their courses. However they receive financial support from the state.

The first universities were set up in medieval times, including Oxford (1167), Cambridge (1209), St. Andrew's (1413), Glasgow (1451), Edinburgh (1582). The two oldest universities in the United Kingdom are Oxford and Cambridge. Both universities comprise many buildings of great beauty and antiquity, near slow-moving rivers suitable for rowing and punting. Oxford and Cambridge have a great deal in common. Each university has more than 30 self-governing colleges and over 20 000 students. The universities are world class in teaching and research in both arts and science subjects.

Central to academic life at Oxford and Cambridge is the tutorial, which is an hour-long meeting between one to three students and their tutor. A great advantage of the tutorial system is the individual attention that students receive. Although there may be one tutorial a week, students are required to spend many hours independently preparing for this and must come to the tutorial fully ready. Undergraduates are usually expected to present an essay, solutions to a set of problems, or some other **project. The tutor's role is to assess this work and, through discussion,** help undergraduates to think critically and creatively about their chosen subject. This personal tuition enables students to explore course material

in much greater depth than lectures allow and to clarify anything students are not clear about.

The Universities of Oxford and Cambridge (or Oxbridge, as they are **jointly called**) **have produced a large number of the world's most prominent** scientists, writers and politicians, including Charles Darwin, Isaac Newton, Oscar Wilde, Margaret Thatcher, Indira Gandhi, Bill Clinton and many others.

The largest university in the country is London University which was founded in 1828. It is made up of a great variety of colleges with 120,000 students.

The rapid growth of the cities in the nineteenth and the beginning of the twentieth century resulted in the establishment of the so-called **'red brick' universities**. **The origin of the word 'red brick' comes from the** popular building material of that time. Examples include Bristol, Manchester, Birmingham, Leeds, Sheffield and others. These universities were created to fill local needs, the emphasis was placed on the study of science and technology. Currently they offer a full range of courses.

Higher education in Britain considerably expanded in the 1960s. New campus-based universities were set up at Essex, York, Kent, Lancaster and other cities. The creation of the Open University in 1969 marked the new era in higher education. The Open University is a world leader in modern distance learning. It enables people to study at times and in places to suit them. Information and communication technology plays a big part in the OU study. Students are provided with interactive teaching and multimedia materials. Tutors offer support to students by e-mail and computer conferencing.

An academic year in Britain usually starts in autumn and is divided into three terms. A typical university consists of a number of faculties: Arts, Education, Social Sciences and Law, Engineering, Biological Sciences, Medicine and Health and others. At the head of each faculty there is a professor. All universities offer students a wide variety of accommodation in the halls of residence, located on the campuses and surrounding areas. **Every University has a Students' Union** which organizes recreational activities for students.

The main teaching and assessment methods in British universities are: lectures, laboratory practicals, seminars, tutorials, e-learning, projects and examinations. Engineering degree courses are available in the great majority of UK universities. Most courses last three or four years. The

majority of undergraduate degrees are offered as a three-year BEng (Bachelor of Engineering) or four-year MEng (Master of Engineering). One-year postgraduate MSc (Master of Science) degree in specialist fields is also common. UK qualifications in engineering are recognized worldwide.

## SKILLS

### Exercise 1.

Discuss whether these statements are true or false. Correct the false ones. Use the expressions from the Useful language box below.

- 1) **Universities in Great Britain are private and they don't receive any financial support from the state.**
- 2) The first universities in Britain were founded in medieval times.
- 3) Cambridge University is older than Oxford.
- 4) Each tutor has from five to ten students.
- 5) London University is famous for its antique way of life and a great variety of colleges.
- 6) Bristol, Manchester, Birmingham, Leeds, Sheffield are known as **'red-brick' universities.**
- 7) New campus-based universities were set up in the 1960s.
- 8) The academic year in Great Britain starts in summer and is divided into three terms.
- 9) It takes five years to get a Bachelor of Engineering degree.
- 10) The only teaching and assessment methods in all British Universities are tutorials.
- 11) Information and communication technology is essential in the Open University study.
- 12) UK qualifications in engineering are recognized all over the world.

Useful language

*I think so*

*I'm quite positive about it*

*Absolutely right*

*I agree only to some extent*

*Certainly*

*I disagree*

*I'm of the opposite opinion*

*Far from it*

*It's false, I'm afraid*

*I can't agree with it*

### Exercise 2.

Work in pairs. Imagine that your friend is planning to study in Great Britain. Interview him (her) about the university he (she) wants to choose. Put the words in the questions in the correct order and then complete the dialogue.

A) town / or / you / Do / city / want / a small / to study / in a big?

**B) Personally, I ...**

A) Do / prefer / you / university /or /one / studying / at /a larger/ a smaller?

**B) You know, ...**

A) you / one / university / an ancient / Do / or / to choose / a new / want ?

**B) Actually, I ...**

A) What / will be / activities / to / available /you / academic?

**B) I think, ...**

A) like / What / you / the university / facilities / would / to have / at?

**B) It would be great to have ...**

A) prefer / in University accommodation / sector / Do / in the accommodation /or / you /to live/ in the private?

**B) Well, you know, I'd rather live ...**

A) need / an English / you / language / to study / qualification / Do/ at the UK university?

**B) Sure, ...**

A) is / in / What / the tuition fee/ the British universities?

**B) As I know, ...**

### Exercise 3.

Work in groups of three or four to discuss in what ways the system of higher education in Great Britain is similar to, or different from that in our country? Use the headings below and the expressions from the Useful language box to help you.

- the admission to the universities
- the academic year
- the main teaching and assessment methods
- the degrees provided by the universities
- facilities and opportunities offered by the universities

BELARUS	GREAT BRITAIN
If I remember right higher education in Belarus is provided <b>by...including...</b>	As far as I know in Britain higher <b>education is mostly provided by...</b>
I know that in Belarus universities <b>admit students after...</b>	If I am not mistaken the admission to universities in Great Britain <b>is by...</b>
I know exactly that the academic <b>year in Belarus starts in... and is divided into...</b>	Unlike Belarus the academic year in <b>Britain is divided into...</b>
I think that the main teaching methods in Belarusian universities <b>are... . And the students are assessed at the end of each term through...</b>	It seems to me that British universities also use such teaching and assessment methods <b>as...</b> Moreover the most important teaching method of <b>Oxford and Cambridge is...</b>
Students in Belarus graduate after <b>... years with...</b>	But in Great Britain most courses last <b>...</b>
I am sure that all universities in Belarus offer a wide range of undergraduate and postgraduate <b>degrees such as...</b>	It seems to me that the majority of undergraduate and postgraduate degrees in the UK are offered as <b>...</b>
As far as I know Belarusian universities support students <b>providing them with...</b>	And British universities offer their <b>students a great variety of...</b>

#### Exercise 4.

Work with a partner and prepare a five-minute presentation about your dream university using the questions below. Give your presentation to the class.

- 1) Where is the university located?
- 2) What courses does it run?
- 3) How much does the course cost?
- 4) What are the dates of the terms? Are they convenient?
- 5) What is the length of the course?
- 6) Is teaching carried out in small groups (tutorials) or large groups (lectures)?
- 7) How are the students assessed?
- 8) What facilities does the university offer?

Exercise 5.

Translate the sentences below into English:

1) Британские университеты являются автономными учреждениями, которые сами определяют продолжительность курсов обучения и содержание учебных программ.

2) Одним из главных условий приёма (поступления) в Британские университеты является соответствующий уровень академической подготовки.

3) Университеты Оксфорда и Кембриджа имеют много общего и знамениты своей индивидуальной системой обучения, которая позволяет студентам более глубоко изучить материал.

4) Знаменитая регата (boat race) по гребле между Оксфордом и Кембриджем – это уникальное спортивное событие, которое проводится на реке Темзе с 1829г.

5) «Краснокирпичные» университеты, построенные в промышленных городах из кирпича, заметно отличались (to look completely different from) от древних каменных стен Оксфорда и Кембриджа.

6) Открытый Университет Великобритании всегда являлся мировым лидером в области использования информационных технологий, что даёт возможность получать высшее образование в любой точке мира.

7) Открытый Университет применяет широкий спектр методов для дистанционного обучения, включая Интернет-конференции, сопровождаемые поддержкой преподавателя-консультанта.

8) Курс обучения на степень бакалавра в университетах Великобритании по большинству специальностей составляет три или четыре года.

9) Университеты Великобритании предоставляют студентам не только условия для учебы, а также для спорта и развлечений.

10) Британские университеты имеют всемирно признанную репутацию благодаря выдающимся академическим достижениям и высочайшему уровню научных исследований в различных областях знаний.



UNIT 3  
*The Belarusian National Technical University*

STARTING UP

Exercise 1.

Learning at university is often different from school or college. Choose three things that impressed you greatly when you started learning at the University:

- the campus area
- a large number of students
- different kinds of classes
- the opportunity to feel part of campus life
- large library resources
- the opportunities to practice sports at all levels
- a variety of engineering laboratories
- numerous out- of-class social and sporting activities
- a wide range of clubs and societies

Use the model:

*When I started learning at the University I was greatly (really) impressed by...*

*From my first days at the University I was surprised by...*

Exercise 2.

Discuss these statements. Use the expressions from the Useful language box to help you.

1. Knowledge is power.
2. The roots of education are bitter, but the fruit is sweet.

Useful language

**In my opinion, one of the most important things in our life is...**

**I consider that learning is always hard but...**

**From my point of view, many young people...**

**As I see it, it is necessary to ...**

**I believe getting higher education is a good way to find...**

**It seems to me education provides a good opportunity to...**

**I'm sure that deep knowledge in different fields helps to...**

**It is clear that in order to be successful you have to...**

## VOCABULARY

### Exercise 1.

Match the English words and phrases with their Russian equivalents.

1. to be at the forefront	a. участвовать
2. department	b. спортивная площадка
3. recreation	c. поощрять
4. pitch	d. выполнять
5. state-of-the-art	e. признанный
6. trade union	f. сборная команда
7. proficiency	g. кафедра
8. to take charge of smth.	h. учеба
9. to undertake	i. ценить
10. to compete	j. современный
11. to get involved in smth.	k. многонациональное учебное заведение
12. ingenuity	l. быть на передовой
13. learning	m. профсоюз
14. ability	n. отдых, развлечение
15. industrially focused	o. взять на себя ответственность за что-либо
16. to encourage	p. мастерство, сноровка, умение
17. combined team	q. изобретательность
18. leadership characteristics	r. межуниверситетский
19. to value	s. соревноваться
20. inter-university	t. практико (промышленно) -ориентированный
21. multicultural institution	u. поездка
22. recognized	v. способность
23. ride	w. лидерские качества

### Exercise 2.

Match the words to their definitions. Check any unknown words in a dictionary.

Multicultural, pitch, hall of residence, postgraduate, gym, proficiency, coursework, to be at the forefront, competition

- a. a university building where students live
- b. work students do during a course of study, and that forms part of their final mark
- c. a special building or room that has equipment for doing physical exercises
- d. **someone who is studying to get a Master's degree or a higher one**
- e. to be in a leading position in an important activity that is trying to achieve something or develop new ideas
- f. an organized event in which people or teams compete against each other
- g. involving or including people from many different countries, races or religions
- h. a marked out area of ground on which a sport is played
- i. a good standard of ability or skill

### Exercise 3.

Match the words with a similar meaning. Check any unknown words in a dictionary.

1. a range of	a. entertainment
2. conveniently	b. extracurricular
3. to encourage	c. a number of
4. ingenuity	d. pioneering
5. out-of-class	e. to admit
6. innovative	f. comfortably
7. opportunity	g. to stimulate
8. to take part in smth.	h. to hold
9. to welcome	j. training
10. leading	k. inventiveness
11. teaching	l. to guarantee
12. to contain	m. top
13. recreation	n. to get involved in smth.
14. to ensure	p. chance

#### Exercise 4.

Check that you know the meanings of the phrases. Then complete the sentences below.

Academic staff, full-time and part-time basis, specialist skills, pass-fail system, to undertake research, state-of-the-art sports complex, indoor and outdoor sports facilities, out-of-class activities, combined teams, technical proficiency

1. **A ... offers modern . . . .**, such as training equipment and pitches to keep students fit and healthy.

2. The University is very proud of the successful activity of its 33 ... in 26 sports participating in inter-university and national competitions.

3. The BNTU academic programmes help students to develop a **range of ... appropriate for the working world.**

4. Students are assessed through a . . . ., oral and written examinations at the end of each term.

5. Student life is very active at the BNTU. **In students'** free time they can take full advantage of . . . . to demonstrate their abilities and interests.

6. . . . . supports students to develop the skills they need to do well in their studies.

7. Every year students are encouraged to . . . . in many engineering disciplines to develop their analytical and problem-solving skills.

8. A high level of . . . . . gives students an opportunity to get an excellent job.

9. The University offers an opportunity for students to study on . . . . and . . . .

#### READING

##### Exercise 1.

What do you know about the Belarusian National Technical University?

Do the general knowledge quiz below and then check your answers by reading the text.

## General Knowledge Quiz

1. **The BNTU was founded in ... on the basis of ...**
  - a. 1820 ... the College of Science
  - b. 1910 ... the College of Engineering
  - c. 1920 ... the Polytechnic College
  
2. The university consists of ... faculties.
  - a. 10
  - b. 15
  - c. 17
  
3. About ... students are taught on full-time and part-time basis in ... specialities at the BNTU.
  - a. 20 000 ... 70
  - b. 25 000 ... 78
  - c. 35 000 ... 88
  
4. The university provides the students with accommodation in ... halls of residence.
  - a. 8
  - b. 10
  - c. 15
  
5. The university is an excellent ... centre.
  - a. research
  - b. recreation
  - c. study, research and recreation centre

### *The Belarusian National Technical University*

The Belarusian National Technical University was founded in 1920 on the basis of the polytechnic college. Now the BNTU is considered to be the leading university in the field of higher engineering education in the Republic of Belarus. The University offers a great choice of engineering courses along with excellent study and research facilities.

The BNTU not only welcomes students from all over Belarus, its reputation worldwide makes it a multicultural institution with students from 30 countries. The University is divided into 17 Faculties, including

Mechanical Engineering, Power Engineering, Automobile and Tractor Engineering, Mining and Environmental Engineering, Information Technology and Robotics, Instrumentation Engineering, Military Engineering and others. Each Faculty is subdivided into a number of departments and scientific research laboratories. About 35,000 students are taught on full-time and part-time basis in 88 specialities.

There are more than 2,000 highly qualified members of the academic staff at the University. Many of them have academic degrees and undertake fundamental and industrially focused research across a wide range of engineering disciplines. Through the programmes of study, students develop their intellectual abilities and specialist skills that employers value in **today's university** graduates. The BNTU students are encouraged to be organised, initiative and take charge of their learning.

Lectures, seminars, laboratory and practical classes make up the majority of teaching time. Students are usually assessed at the end of each semester through a pass-fail system, written and oral examinations, and through coursework in the form of projects.

The BNTU campus is regarded as one of the largest and most attractive in the country. Conveniently located in the city centre, the campus offers excellent facilities for teaching, learning, research and recreation. As a student at the BNTU you are able to use one of the largest university libraries in Belarus, containing over two million books, many reading halls with quiet study places, well-equipped engineering laboratories and computing centres.

The BNTU has always been one of the top sporting universities, providing opportunities for sports participation at all levels. A state-of-the-art sports complex offers indoor and outdoor sports facilities, including many sports halls, a gym, a stadium with high quality pitches for a variety of sports. 33 combined teams in 26 sports are involved in inter-university competitions. Handball and basketball teams compete at a national level.

Choosing a university is about choosing home. The University provides students with accommodation in 15 halls of residence, all located within a short walk or the underground ride from the campus. University life is more than just lectures and exams. To ensure that your years at the University are the best **of your life**, the **Students' Trade Union** offers a wide range of entertainment and support for students. Numerous clubs and societies provide the opportunity to get involved in different out-of-class activities, from learning a foreign language to dancing.

The University is internationally recognized for its research, development and innovation. Every year both academic staff and students take part in scientific and technical conferences. The University is one of the main centres of postgraduate teaching in the country. All research degree courses offer research skills training to help postgraduate students realise their potential as researchers. The BNTU is developing strong links with industrial enterprises, academic and research institutions in Belarus and abroad.

The BNTU graduates stand at the forefront of Belarusian industry, possessing strong leadership characteristics, ingenuity and technical proficiency. The University provides educational experience that encourages students for lifelong learning and to continuously improve their knowledge and competence.

## SKILLS

### Exercise 1.

Answer the questions about the text.

1. When was the University established?
2. What status does the University have in Belarus?
3. How many faculties does the BNTU consist of? What are they?
4. Is the academic staff numerous at the University?
5. **What skills and qualities do employers value in today's university graduates?**
6. What is the University campus like?
7. What study facilities does the University offer?
8. Why is the BNTU considered to be one of the top sporting universities in the country?
9. Does the BNTU provide students with accommodation?
10. What recreation activities are available for the BNTU students?
11. In what way is research work organized at the University?
12. What are the advantages of the BNTU educational experience?

### Exercise 2.

Discuss whether you think these statements are true or false.

1. The BNTU was founded in 1922 on the basis of the polytechnic college.

2. The University only welcomes students from Belarus.
3. About 35 000 students study on full-time and part-time basis.
4. Highly qualified academic staff are only involved in teaching.
5. **Study programmes are designed to develop students' intellectual abilities and specialist skills which are very important in the job market.**
6. Lectures and seminars make up the majority of teaching time.
7. A state-of-the-art sports complex offers indoor sports facilities.
8. **All University's halls of residence are located far from the campus.**
9. **The Students' Trade Union offers social and sporting activities organized by students for students.**
10. The BNTU is developing national and international partnerships with other leading universities and industry.

### Exercise 3.

The University Open Day is a day to **discover what it's really like** at the University. Have you attended the Open Day? If yes, then was the visit useful? **Describe your general impressions. If you haven't** attended the Open Day, describe what can applicants (**абитуриенты**) find out on this day using your general knowledge and expressions from the Useful language box.

#### Useful language

*to have the opportunity to look around the campus, to find out detailed information about the admission process and career prospects, to take part in a number of talks on many aspects of life and study at the University, to find information on issues such as scholarships and fees (оплата за обучение), accommodation and extracurricular activities, to gain impression of a student life at the University, to have the chance to talk to the current students and hear a firsthand account (мнение из первых рук) of the student experience, to learn more about courses and facilities, to have the opportunity to ask the Faculty staff any questions about the Faculty and the courses it offers*

*You can begin like this: The Open Day as a whole was an amazing experience because it gave me an idea of what to expect if I were to study at the BNTU. I learnt more about ...*

### Exercise 4.



Work in groups of three or four. Do you agree or disagree with these statements? Give reasons for your answers. Use expressions from the Useful language box to help you.

1. Your years at the University are the best of your life.
2. Students need to be organized, initiative and take charge of their learning.

Useful language

1. *to get the most out of your university life, to have the opportunity to get involved in a wide range of academic, social and sporting activities, to meet people with a common academic interest, to make a lot of new friends, to create lasting friendships, the University allows both to learn and have fun, numerous clubs and societies provide a place to meet like-minded (имеющий схожие пристрастия) people or simply socialize*

2. *the University offers an educational experience designed to help... , students need to get used to different kinds of learning required in certain subject areas, it's a different sort of atmosphere from school, to be far more independent, to be responsible for one's own learning, to come to the classes fully ready, to spend many hours independently preparing for studies*

Exercise 5.

Put the words in these questions in the correct order. Then match them with the answers to make a dialogue about the University.

1. it / for you / hard / university life / to settle down / was / into?
2. any / there / difference / is / university and school / between?
3. you / feel / any / do / support / the teachers / from?
4. take part / do / in the events / **you / by the Students' Union** / organised?
5. have / in the halls of residence / you / **accommodation / don't you?**
6. what / available / are / sports / to students?

a. There are 26 different sports societies within the sports complex. We have sports like football, volleyball and lots of martial arts (**боевые искусства**) as well.

b. There are really good teachers. They really give a lot of help. It **might seem there's no support there, but as soon as you just ask for it, it's always available.**

c. **Actually, I do. It's a good standard accommodation, just a short walk from the campus.**

d. Well, it was a bit scary, to be honest, leaving home for the first time, going to live in a new place, but I quickly settled in and found it very friendly.

e. Sure. You know, university life is more than just lectures and exams. The Union really tries to encourage any student to be active and participate in a wide range of social and sporting activities. It makes our life here more enjoyable.

f. **I think there's a big difference between university and school. Here you're far more independent** and responsible for your own learning.

### Exercise 6.

Role-play the University Open Day. Work in pairs to complete the dialogues below. Discuss university life at the BNTU. Student A - an applicant who wants to learn more about university life. Student B – a current BNTU student who offers firsthand advice based on his/her experience of life at the University.

#### Dialogue 1

A: Excuse me, are you a BNTU student?

**B: Yeah, I'm a ...-year student of ... Faculty.**

**A: You know, I'm going to enter the BNTU this year. Do you have any idea if all the Faculties are ...?**

B: Sure, many Faculties including ... are located on campus, others are ...

A: The campus is really large. Are the classes held in one ... or in ...?

B: Actually, we have classes in different buildings. It usually takes us ... minutes to ... .

A: What kinds of classes ... ?

**B: We have ..., ..., ..., and laboratory classes as well. You'll have to spend many hours independently to ...**

A: Was it hard for you to settle down into university life?

**B: Well, ...**

A: I see, thanks. Your advice is really helpful.

B: No problem.

#### Dialogue 2

A: Excuse me, I'm looking for the Automobile and Tractor Faculty?

**B: Yeah, it's situated in ...**

A: Oh, the campus is so large! Is there a library and a sports complex?

B: Actually, there are all these facilities on the campus. The BNTU library is ... . **A state-of-the-art sports complex offers ... .**

A: You know, I'm just interested, as I'm going to enter the BNTU this year.

B: I see, go ahead.

A: **How many classes a day ... ?**

B: You know, our timetable is really busy! There are ... a day. We study a large number of subjects like ...

A: **Do you have any time for ... activities?**

B: **Yes, I usually take part in the events organized by our Students' .... It's always fun!**

A: **Thanks, you've been very helpful.**

B: **It's OK.**

### Dialogue 3

A: Excuse me, is there a café on the campus?

B: **Sure, there is a café or a canteen in each building. They serve a wide range of hot meals, snacks, ...**

A: **Thanks. By the way, don't you live in the halls of residence? I'm just interested, as I'm going to enter the BNTU this year.**

B: I see. Yeah , **I have the University's ...**

A: Is it far from the campus?

B: **No. it's just ...**

A: Is it difficult to study at the BNTU?

B: Quite difficult. During the term we ... **At the end of the semester ...**

A: Do you feel any support from the teachers?

B: **Yeah, they really give you a lot of help, but you have to take ... learning as well.**

A: I see, thanks. Your advice is really useful.

B: No problem.

### Dialogue 4

A: Excuse me, is there a photocopy centre on the campus?

B: Yes, the nearest one is in the library.

A: What other facilities are available at the library? I'm just interested, as I'm going to enter the BNTU this year.

B: Oh, I see. As I know, there is a Wireless Access Point, a lot of ...

A: Do you use any of these resources?

B: Sure, especially when I get ready for ... or write a ...

A: Do all the Faculties study on the first shift?

B: Not really. Some Faculties ... the others ...

A: I was told that many students receive ... . How much is it?

B: It depends. It's from ... to ... a month.

A: I see. Thanks, you've been very helpful.

B: That's all right.

Exercise 7.

Translate the sentences below into English:

1. Во время учебы в университете студенты развивают свои интеллектуальные способности и профессиональные навыки, а также становятся более инициативными и организованными.

2. Университет включает в себя 17 факультетов. Более 35000 студентов из разных уголков Беларуси и зарубежных стран учатся в БНТУ.

3. БНТУ предлагает студентам как очную, так и заочную формы обучения.

4. Ежегодно студенты и преподаватели проводят практико-ориентированные исследования в области инженерного дела, а также представляют результаты исследований на научно-технических конференциях БНТУ.

5. Университет предоставляет студентам не только широкий круг технических специальностей, а также благоприятные условия для обучения и развития личностных качеств студентов.

6. Каждый факультет предоставляет студентам возможность приобретать практические навыки в хорошо оборудованных технических лабораториях и вычислительных центрах.

7. БНТУ обеспечивает многих студентов жильём в общежитии, которые расположены в шаговой доступности от университетского городка.

8. Спорт очень популярен среди студентов БНТУ. Современный стадион с большим количеством площадок для раз-

личных видов спорта, спортивные залы, тренажёрный зал доступны студентам университета.

9. Знания и навыки, полученные в университете, позволяют студентам быть востребованными на рынке труда.

10. Профессорско-преподавательский состав постоянно поддерживает студентов в их стремлении (aspiration) к непрерывному образованию и к улучшению своих знаний и компетенций.

## UNIT 4

### *The University of Manchester*

#### STARTING UP

##### Exercise 1.

What do you know about the city of Manchester?

Do the general knowledge quiz below to find out more about Manchester.

#### General Knowledge Quiz

1. Manchester is situated in
  - a) Scotland
  - b) England
  - c) Wales
2. Museum of Science and Industry in Manchester is
  - a) a place for tourists where you can buy various pieces of art
  - b) a great place to learn more about the city's industrial beginnings and amazing scientific achievements
  - c) the only historical place in the UK left after the World War II
3. Manchester United is
  - a) a textile company
  - b) a hotel
  - c) a football club
4. The University of Manchester is
  - a) a medieval University
  - b) a red brick University
  - c) a new campus-based University
5. The University of Manchester is the place where scientists first
  - a) split the atom
  - b) invented the radio
  - c) designed the first space shuttle

## Exercise 2.

Discuss these questions:

1. Do you know any world-famous British universities?
2. What do you know about these universities?

## VOCABULARLY

### Exercise 1.

Match these words and phrases with their Russian equivalents.

1. to establish	a. решение задач
2. Faculty of Humanities	b. школы с высоким рейтингом
3. multicultural community	c. обеспечивать, гарантировать
4. current staff	d. применять, употреблять
5. to award	e. учитывать, удовлетворять требованиям
6. Faculty of Life Sciences	f. факультет гуманитарных наук
7. to undertake in-depth study	g. гражданские ценности
8. to cater for	h. логическое мышление, рассуждение
9. cutting-edge	i. виртуальная среда обучения
10. forward-thinking	j. самый современный
11. to apply	k. соединять, объединять
12. virtual learning environment	l. проводить глубокое исследование, анализ
13. to ensure	m. устная коммуникация
14. reasoning	n. действующий преподавательский состав
15. problem-solving	p. основывать, учреждать, устанавливать
16. civic values	q. многонациональное сообщество
17. verbal communication	r. факультет медицинских и социальных наук
18. highly-rated Schools	s. факультет биологических наук
19. bring together	t. прогрессивно мыслящий
20. Faculty of Medical and Human Sciences	v. награждать, присуждать

### Exercise 2.

Complete these sentences with the words and phrases from the box. Use a good dictionary to help you.

Forward-thinking, current, staff, values, tutorials, diverse, research, cutting-edge, created, catering for

1. The University of **Manchester** was ... **in 1824**.
2. The University of Manchester is a highly selective 'elite' UK institution which comes **3rd in terms of ... after Cambridge and Oxford**.
3. **Our academic ... are leaders in their field and their research** directly improves their teaching.
4. Faculty of Engineering and Physical Sciences brings together **nine ... Schools**.
5. There are four **Nobel Laureates among ... staff**.
6. The main teaching and assessment methods in British universities are: **lectures, ... laboratory practicals, projects, seminars, e-learning** and exams.
7. **The University has ... scientific facilities**.
8. **The Athletic Union is made up of 46 sport clubs, ... all levels**.
9. The university courses equip students with not only academic knowledge, but also personal skills such as critical thinking, reasoning **and analysis, civic ... and responsibilities**.
10. These skills will be useful across a ... range of careers.

### Exercise 3.

Match the words with a similar meaning.

1. staff	a. to guarantee
2. to establish	b. to contain
3. to apply	c. to devote
4. to allow	d. contemporary, state-of-the-art
5. to include	e. to permit
6. to dedicate	f. detailed and thorough
7. to ensure	g. to combine
8. to conduct research	h. to found
9. in-depth	j. personnel
10. cutting-edge	k. to carry out investigations
11. to bring together	l. to utilize, to use

## READING

### Exercise 1.

Before you read the text, discuss these questions:

1. Would you like to study in a foreign country?
2. In your opinion, is it difficult to enter a British university?
3. Do you know the entrance requirements for overseas universities?
4. Would it be difficult for you to join the multicultural community?

### Exercise 2.

Go through the text to find this information:

- a) the number of students at the University of Manchester
- b) the number of Noble Prize winners of the University
- c) cutting-edge scientific facilities
- d) the name of the virtual learning environment
- e) the most important inter-university sporting event

### Exercise 3.

Read the text carefully and do the exercises after the text

### *The University of Manchester*

The University of Manchester **is one of Britain's most forward-thinking** universities. It was established in 1824. The University has always been at the forefront of new discoveries in science and engineering. Manchester is the place where scientists first split the atom and invented the modern computer.

The University of Manchester is divided into four Faculties. These include Faculty of Engineering and Physical Sciences, Faculty of Humanities, Faculty of Life Sciences, Faculty of Medical and Human Sciences. Each Faculty is divided into a number of Schools. For instance, Faculty of Engineering and Physical Sciences brings together nine highly rated Schools, each with a powerful reputation for teaching and research success. There is, School of Mechanical, Aerospace and Civil Engineering, School of Electrical & Electronic Engineering, School of Computer Science, School of Materials, School of Mathematics, etc.

**The University's campus is home to more than 37,000 students from** around 150 countries, creating a diverse and multicultural community.



More than 5,600 academic and research staff provide stimulating learning environments and excellent standards of teaching.

The University of Manchester is one of the country's major research universities. There are 50 specialist research centres, conducting pioneering research in areas ranging from nanotmaterials to artificial intelligence. 25 Nobel Prize winners have worked or studied here and there are four among current staff. Professors Andre Geim and Konstantin Novoselov were awarded the Nobel Prize for Physics in 2010. These scientists invented graphene – **the world's thinnest, strongest and most conductive material.**

The University offers a wide range of undergraduate and postgraduate degrees. A postgraduate research degree allows students to undertake in-depth study in a specific area, which is then written up as a thesis.

Students at the University of Manchester have access to world-class study facilities. They include one of the largest university libraries in the UK, with more than four million books, a large collection of electronic resources, and more than 3,200 computers across campus. There are a lot of Wireless Access Points across the University campus. These allow **students to use their own laptops on the University's high-speed network** and connect to the internet quickly.

The University has cutting-edge scientific facilities, like Jodrell Bank Observatory, Manchester Interdisciplinary Biocentre, the Photon Science Institute, and the Integrative Centre for Molecular Cell Biology.

Many programmes of study include online components. The University of Manchester has a virtual learning environment (VLE) called Blackboard. This means you might study online using material created by your lecturers, download papers and take online tests, or access relevant audio and video material.

World-class sports facilities give students plenty to do outside lectures. The Athletic Union is made up of 46 sport clubs, catering for all levels, from beginners up to elite athletes. Most compete in the British Universities and Colleges Sport Leagues against other universities.

**The Students' Union has its own shops, cafes and bars, and it provides everything that students need to enjoy their time at Manchester University to the full.**

At university a strong emphasis is placed on teaching students to apply information. Students are encouraged to read widely, to question

and analyse what they have read, and to discuss openly their own ideas in seminars and tutorials.

This ensures that university courses equip students with not only academic knowledge, but also personal skills that will be useful across a diverse range of careers. These include: critical thinking, reasoning and analysis, advanced written and verbal communication, problem-solving and teamwork, civic values and responsibilities as citizens of the future.

## SKILLS

### Exercise 1.

Match the first part of the sentence (1-6) with the second part (a-f).

1. Thousands of Manchester students are now <b>benefiting from ...</b>	a. provides teaching, learning and assessment materials and activities online, as well interactive discussions with teaching staff;
2. Blackboard Learning System ...	b. teaching students to apply information;
3. The University of Manchester	<b>c. access to the University's Blackboard Learning System;</b>
4. At university a strong <b>emphasis is placed on ...</b>	d. <b>invented the world's thinnest,</b> strongest and most conductive material;
5. University courses transfer academic knowledge, <b>as well as ...</b>	e. enjoys a global reputation for both pioneering research and problem-based approach to learning;
6. Professors Andre Geim and Konstantin <b>Novoselov...</b>	f. some useful skills such as critical thinking, problem-solving and team work, civic values etc.

### Exercise 2.

Decide whether the following statements are true (T) or false (F).

1. The University of Manchester was created in the 18<sup>th</sup> century.
2. The University of Manchester consists of fourteen Faculties.
3. Each Faculty consists of a number of schools.
4. The University of Manchester enjoys a global reputation for both its pioneering research and problem-based approach to learning.

5. Blackboard is a virtual learning system created specially for part-time students.

6. Jordell Bank Observatory and the Photon Science Institute are cutting-edge sports facilities at Manchester University.

7. The library of the University of Manchester is the largest library in the UK.

8. Wireless Access points allow Manchester students to connect to the Internet quickly.

9. The University of Manchester is aimed at providing students with academic knowledge and developing civil values and responsibilities.

10. The Athletic Union consists of 46 sport clubs for professional athletes.

### Exercise 3.

Work in groups of three or four to discuss in what ways your University is similar to, or different from the University of Manchester. Use the headings below and the expressions from the Useful language box to help you.

- date of creation
- number of students
- number of Faculties
- study facilities
- research facilities
- assessment system
- sports facilities

#### Useful language

In my opinion, both Universities have...

As far as I know, ...University is older than ...

I consider, the students of ...University have better access to ...

From my point of view, the largest University library is ...

As I see it, the students of ...University have more opportunities to...

I believe, the academic methods at ... are more innovative and encouraging than at ...

It seems to me, the Universities differ in...

I'm sure that the common features of both Universities are...

It is clear that both universities provide...

I'm positive that the University offers its students excellent... compared to ...

#### Exercise 4.

A group of students from the University of Manchester has arrived in Minsk to take part in the Prospects of Engineering Education Conference. The questions below were asked. Put the words in these questions in the correct order. Then match the questions with the answers below.

1. there/ of /what/ kinds/ at /classes/ are/ Manchester University?
2. the /what/ helpful/ in/ are/ ways / tutorials?
3. number/ people/ is/ average/ the/ of/ what/ in/ your/ lectures?
4. with/ students/ accommodation/ provided/ are/ first-year/ all/ University?
5. international/ come/ countries/ what/ from/ students/ do?
6. available/ you/ scientific/ are/ facilities/ Manchester/ what/ to/ at?
7. benefits/ Union/ what/ offer/ **the/ does/ Students'/ you?**
8. advantage/ activities/ what/ take/ of/ you/ out-of-class/ do?

a) What I really like about our tutorial system is that you can talk **with your personal tutor about specific parts of the lecture you don't understand.**

b) As I know, they come from all over the world including Russia, China, Hong Kong, Taiwan, India, Arabic and African countries.

c) Actually, we have access to outdoor and indoor sports facilities, social and entertainment events. Once a week practice swimming and go to the fitness centre.

d) Well, we have a wide range of classes such as lectures, laboratory **practicals, projects, seminars, tutorials and we have this ...er...what we call... e-learning system.**

e) For my course we have about 400 people in a big lecture theatre.

f) **The Students'** Union supports all kinds of social and sporting activities, various clubs and societies.

g) Sure, all first-year students are offered a place in the University halls of residence, located both on our campus and in surrounding areas.

h) **You know ... we have an impressive range of facilities to support our research.** My group mates and I carry out research in electrical and mechanical workshops.

What other questions would you like to ask the students of the University of Manchester? Think of two or three more questions.

### Exercise 5.

Work in pairs to complete the dialogue below.

A: a BNTU student.

B: a Manchester student.

A: Are there many international students at Manchester University?

B: Sure. **There are ... . What about your University?**

A: **As I know, ... .**

B: By the way, how many Faculties are there at the BNTU?

A: **You know, there are ... such as ... . Is the number of Faculties the same at your University?**

B: **No, we only have ...**

A: Oh, really? Why so few?

B: Yeah, but each **Faculty includes ...**

A: Is it difficult to study at Manchester?

B: **Certainly, but we get a lot of support from ... and it's a good thing that we have free access to ... . Do you have any IT services?**

A: **Yes, we have some. For example, ... .**

B: You look fit! Do you practice sport?

A: **Yes, I'm fond of ... . Actually, we have plenty of sports facilities like ... . Is sport popular with Manchester students?**

B: **Yes, quite. We have ... as well . What do you do outside lectures?**

A: **You know, our Students' Union organisers ... . Do you have a similar organisation?**

B: Yeah, **sure...**

### Exercise 6.

Translate the sentences below into English:

1. Манчестерский университет обладает высокой репутацией во всём мире благодаря эффективной работе действующего преподавательского состава, самым современным научно-исследовательским центрам, а также стимулирующей обучающей среде.

2. Университет всегда находился на передовой новых открытий и технологий.

3. Университет включает в себя различные факультеты: факультет технических и физических наук, факультет

гуманитарных наук, факультет биологических наук и др. Такое разнообразие факультетов отвечает потребностям абитуриентов в приобретении знаний по различным предметным областям.

4. В университете обучается более 37 тысяч студентов из 150 стран мира, что придает учебному заведению статус многонационального сообщества.

5. Студенты-магистранты имеют возможность проводить углубленное исследование по широкому спектру технических дисциплин.

6. Преимущество учебной программы Манчестерского университета состоит в том, что основной упор делается на применение теоретических знаний на практике, что гарантирует качественную подготовку студентов к их профессиональной жизни.

7. Виртуальная обучающая среда позволяет студентам дневной и заочной форм обучения найти и скачать всю необходимую информацию с университетского сайта для подготовки к экзаменам.

8. Университет готовит прогрессивно мыслящих специалистов, способных к критическому мышлению и анализу информации, навыкам работы в команде, а также решению сложных задач.

9. Университетская программа обучения помогает не только сформировать у студентов навыки усной и письменной коммуникации, но и воспитать чувство ответственности и гражданские ценности.

#### Exercise 7.

Choose a British University. Work with a partner and prepare a five-minute presentation including the following items:

- the date of foundation
- the number of students and their origin
- Faculties and Schools
- degree courses
- study facilities
- **Students' Union**
- accommodation
- tuition fee

You can visit websites like

www.cam.ac.uk  
www.ox.ac.uk  
www.ed.ac.uk  
www.leeds.ac.uk

www.bris.ac.uk  
www.lon.ac.uk  
www.birmingham.ac.uk  
www.liv.ac.uk

Give your presentation to the class.

## *UNIT 5* *My Faculty*

### STARTING UP

Exercise 1. Discuss these questions.

1. What Faculty do you study at?
2. What social or sporting activities organized by the Faculty did you get involved in?
3. Do you agree that your Faculty is friendly and supportive? Give reasons.

Exercise 2.

What do you know about the BNTU Faculties?

Do the general knowledge quiz below to find out more about the Faculties of the University.

### General Knowledge Quiz

1. The oldest Faculty of the BNTU is
  - a) Information Technology and Robotics Faculty
  - b) Power Engineering Faculty
  - c) Mechanical and Technological Faculty
2. The youngest Faculty of the University is
  - a) Instrumentation Engineering Faculty
  - b) Military Engineering Faculty
  - c) Sports Engineering Faculty
3. The largest number of students is at
  - a) Mechanical and Technological Faculty
  - b) Automobile and Tractor Faculty
  - c) Mining and Environmental Engineering Faculty
4. The Faculty that trains engineers only on full-time basis is
  - a) Mechanical Engineering Faculty

- b) Power Engineering Faculty
- c) Military Engineering Faculty
- 5. The Faculty that is situated in the 17<sup>th</sup> building is
- d) Instrumentation Engineering Faculty
- e) Information Technology and Robotics Faculty
- f) Automobile and Tractor Faculty

## VOCABULARY

### Exercise 1.

Match the English words (phrases) with their Russian equivalents.

1. research portfolio	a) <b>декан</b>
2. to rename	b) <b>спрос, потребность</b>
3. to establish	c) <b>включать</b>
4. to head	d) <b>общий</b>
5. to separate from	e) <b>переименовывать</b>
6. to give training	f) <b>возглавлять</b>
7. transformation	g) <b>учреждать, основывать</b>
8. to include	h) <b>в тесном сотрудничестве</b>
9. demand	i) <b>исследовательское портфолио</b>
10. in close consultation	j) <b>отделять от</b>
11. common	k) <b>найти работу</b>
12. dean	l) <b>изменение, преобразование</b>
13. to find employment	m) <b>предоставлять подготовку</b>

## READING

### Exercise 1.

Go through the texts and match each student with the Faculty he studies at. Then read the text about your Faculty to discuss the questions that follow it.

1. A student of Mining and Environmental Engineering Faculty
2. A student of Mechanical and Technological Faculty
3. A student of Information Technology and Robotics Faculty
4. A student of Automobile and Tractor Faculty
5. A student of Sports Engineering Faculty
6. A student of Mechanical Engineering Faculty
7. A student of Military Engineering Faculty



8. A student of Power Engineering Faculty
9. A student of Instrumentation Engineering Faculty

Text A. Our Faculty is one of the oldest and largest at the BNTU. It was established in 1951 on the basis of Mechanical Faculty of the Belarusian polytechnic institute. In the late 1940s there was a great demand for automotive engineers as many industrial enterprises including Minsk Automobile Plant, Minsk Tractor Works, the Belarusian Autoworks were built at that time.

At present the Faculty dean is V.V. Ravino, Candidate of Sciences, Associate Professor. The structure of the Faculty includes 12 departments such as: **‘Automobiles’, ‘Tractors’, ‘Technical maintenance of automobiles’, ‘Economy and management on transport’ and others.** Education is provided both at undergraduate and postgraduate levels.

Today more than 2,000 full-time and 1,800 part-time students specialize in such engineering courses as **‘Tractor Engineering’, ‘Automobile Engineering’, ‘Internal combustion engines’, ‘Urban Electric Transport’, ‘Multipurpose Tracked and Wheeled vehicles’, ‘Transport Logistics’, ‘Organization of Road Traffic’ and others.**

Research work is carried out by a number of laboratories including the research laboratory of tractors, mobile systems and machinery, the research laboratory of vehicles, the scientific research centre of road traffic and others.

Text B. Our Faculty was established in 2002 while its origin goes back to 1933. It was called Peat and Melioration Faculty at that time. Today the Faculty provides high quality education in the field of Mining and Environmental Engineering, both at undergraduate and postgraduate levels. At present the Faculty dean is P.V. Tsybulenko, Candidate of Sciences, Associate Professor. Our Faculty includes four departments and trains more than 1000 students in such specialities as **‘Mining Machines and Equipment’, ‘Technology and Equipment of Peat Production’, ‘Mineral Deposits Development’, ‘Ecological Management and Audit in Industry’.** Our Faculty also trains mining engineers for the Republic of Turkmenistan. Graduates of the Faculty mostly work for the enterprises of the Belneftekhim Concern like **‘Belaruskaliy’, ‘Dolomit’** and others. Research work is performed in two research laboratories **‘Ecoprom’ and ‘Technology and machines of potassium production’.**

Text C. Our Faculty is one of the oldest in the BNTU. It started in 1934 as Mechanical and in 1958 it was renamed into Mechanical Engineering Faculty. Today the dean of the Faculty is A.M. Yakimovich, Candidate of Sciences, Associate Professor. The Faculty consists of 8 departments including **‘Metal Cutting Machines and Tools’**, **‘Theoretical Mechanics’** and so on. There are about 3,000 full-time and part-time students specializing in such engineering courses as: **‘Technology of Mechanical Engineering’**, **‘Technological Equipment of Mechanical Engineering Production’**, **‘Equipment and Technologies of Highly Effective Processes of Material Treatment’**, **‘Integrated sensor systems’**, **‘Economy and organization of production’**, **‘Computer Mechatronics’** and others.

Research work is carried out by 6 laboratories including the research an innovative laboratory of plasma and laser technologies, the research laboratory of plasticity, the research laboratory of acoustics and special materials and others.

Text D. Our Faculty was established in 1958 by separating from the Mechanical Faculty. At present the Faculty provides engineering graduates for metallurgical industry, mechanical and instrumentation engineering. Since 2003 the Faculty has been headed by N.I. Ivanitskiy.

**At present the Faculty consists of 8 departments including ‘Machines and Technology of Metal Treatment by Pressure’, ‘Metallurgical Technologies’, ‘Metallurgy of Foundry Alloys’ and others.**

There are about 1600 full-time and part-time students specializing in such engineering courses as: **‘Material Science in Mechanical Engineering’**, **‘Machines and Technology of Material Treatment by Pressure’**, **‘Welding Equipment and Technology’**, **‘Foundry Machines and Technology’**, **‘Powder Metallurgy, Composite Materials and Coatings’**. Research work is carried out by 10 scientific-research laboratories and two research laboratories for students.

Text E. Our Faculty has been part of the BNTU from its very beginnings, since 1920. Today the Faculty provides high quality education in the field of power engineering, both at undergraduate and postgraduate levels. Since 1987 the Faculty has been headed by S.M. Siliuk, Candidate of Sciences, Associate Professor. Our Faculty includes eight departments. More than 3,500 full-time and part-time students specialize

in the following engineering courses: ‘Power Stations’, ‘Power Systems and Grids’, ‘Power Supply’, ‘Thermal Power Stations’, ‘Steam-Turbine Plants of Nuclear Power Stations’, ‘Economy and Industrial Management’ and others.

The current academic staff and students carry out in-depth research in 3 scientific-research and innovative laboratories as well as in the centre of automated control systems in heat power engineering.

Text F. Our Faculty was established in 1983 as the Faculty of Robotics. Since that time the Faculty has gone through numerous transformations. The number of specialities in which training was given became larger. At present the Faculty provides education in the field of information technology and robotics, both at undergraduate and postgraduate levels.

Since 2009 the Faculty has been headed by Y.Y. Trofimenko, Candidate of Sciences, Associate Professor. The Faculty consists of 6 departments including ‘Computer equipment and computer-aided systems software’, ‘Robotic systems’ and others.

The number of students studying on full-time and part-time basis is more than 2,000. Training is given in the following specialities: ‘Software of Information Technology’, ‘Automated Systems of Information Processing’, ‘Automation of Technological Processes and Industries’, ‘Automated Electric Drives’, ‘Industrial Robots and Robotic Complexes’. Research work is conducted in 2 laboratories and aims to develop information technology in education, science and production.

Text G. Our Faculty was established in 1976 as Optical and Mechanical Faculty. Since that time the Faculty has gone through numerous transformations. The number of specialities in which training was given became larger. In 1985 Optical and Mechanical Faculty was renamed into Instrumentation Engineering Faculty.

Since 2010 the Faculty dean has been A.M. Maliarevich, Doctor of Sciences, Professor. The structure of the Faculty includes 8 departments: ‘Design and Manufacture of Instruments’, ‘Standardization, Metrology and Information Systems’, ‘Laser Equipment and Technology’ and others.

Today the Faculty has about 1,600 full-time and 1,000 part-time students specializing in such engineering courses as: ‘Mechanical and Elec-

tromechanical Instruments and Apparatus’, ‘Biotechnical and Medical Apparatus and Systems’, ‘Technology and Equipment of Jewelry Production’, ‘Metrology, Standardization and Certification’, ‘Optical-Electronic and Laser Devices and Systems’, ‘Technical Maintenance of Safety’, ‘Micro- and Nanosystem Devices’, ‘Management’, ‘Economy and organization of production’ and others.

Research work is carried out by 3 laboratories: the research laboratory of optical-electronic instrumentation, the research laboratory of semiconductor devices, the scientific-research centre of optical materials and technologies.

Text H. Our Faculty was created in 2003. It prepares regular officers for the Armed forces of the Republic of Belarus. At present the head of the Faculty is the colonel N.M. Selivonchik. The structure of the Faculty includes 5 departments: ‘Armoured Arms and Technics’, ‘Military Automobile Technics’, ‘Military Engineering Training’, ‘Organization of the financial activity of forces’ and others.

The number of cadets studying at the Faculty is 455. Training is given on full-time basis in the following specialities: ‘Economy and Company Management’, ‘Technical Maintenance of Automobiles’, ‘Multipurpose Tracked and Wheeled Vehicles’, ‘Hoisting-and-Transport, Building and Road Machines and Equipment’, ‘Industrial and Civil Engineering’. Graduates of the Faculty are awarded with the military rank of ‘lieutenant’. The research base is being developed at the moment.

Text I. Our Faculty is the youngest Faculty of the BNTU. It was set up in 2010. The Faculty trains engineers for sports industry.

At present the dean of the Faculty is I.V. Belskiy, Doctor of Sciences, Professor. Our Faculty includes 3 departments: ‘Sports Engineering’, ‘Physical Training’ and ‘Sport’. ‘Sports Engineering Department’ is mainly responsible for the preparation of the specialists working in this field. Training is given on full-time basis in two specialities: ‘Technical Maintenance of Sports Complexes’ and ‘Sports Engineering’. The research base is being developed at the moment.

Graduates of the Faculty are in great demand at the technical maintenance departments of the Belarusian sports and leisure complexes.

Questions to discuss:

1. When was your Faculty established?
2. Who is the dean of the Faculty?
3. What is the structure of the Faculty?
4. How many students study at your Faculty?
5. What specialities are offered at your Faculty?
6. What are you specializing in?
7. What industrial enterprises demand engineers of your speciality?
8. In what ways is research work performed at the Faculty?
9. Are you going to stay in education or go into employment after graduation?

#### Exercise 2.

Read the text about the similar features that all BNTU Faculties have. Complete the sentences with the words from the box.

portfolio, supervisor, courses, academic staff, project, conferences

**The Faculty has high quality ... who are actively involved in teaching and research.** A large number of them have academic degrees. **The Faculty staff has a substantial research ..., including much that is directly supported by industry.** They are also active in consultancy projects and **publication, in organizing national and international ....**

The first year is common to **many engineering .... In the second and third year students study more specific subjects to prepare for later specialization in a particular branch of engineering.** Students also carry **out ... work. The work usually involves original research, and is done in close consultation with a ... from the academic staff.**

The Faculty offers high-quality academic programs designed to prepare students for a dynamic career in the chosen field of engineering.

#### SKILLS

##### Exercise 1.

Study the following abilities, knowledge areas and qualities that engineering students should develop. Which of these are the most important for you? Why? Use the expressions from the Useful language box to help you.

Abilities: *leadership characteristics, teamwork skills, communication skills, decision-making skills, critical thinking, ingenuity.*

Knowledge areas: *science & math, engineering fundamentals, analytical skills, problem-solving skills, design skills.*

Qualities: *to be innovative, to be entrepreneurial, to be creative, to have strong work ethic, to be adaptable in a changing environment, to be responsible in a social and technological context.*

Useful language

to be competitive in the labour market, to be able to construct effective engineering solutions, to meet the challenges of rapidly changing world, to have a successful career, to prepare for my professional career, to unlock my full potential.

Follow the model: *I think teamwork skills, engineering fundamentals and to be adaptable in a changing environment are the most important for me. These skills and qualities will help me to ...*

Which University courses provide you with these skills and experiences?

Exercise 2.

Work in pairs to discuss the opportunities students have after graduation. Complete the dialogue below.

A: a student interested in a career as a researcher

B: a student interested in a career in an industrial company

A: So, what are you going to do after graduation? Have you made up your mind?

**B: Well, I'm not sure. I think I'll go ... . And you?**

**A: You know, I'd rather stay in education to study at a... During the last two years I was involved into ... project.**

**B: Oh, personally, I'm not quite interested in ... . I think it's too boring! Is your supervisor helpful?**

A: Actually, ... . **Have you already applied for ... ?**

B: Yes, I have. When I was sent out on an industrial placement I was offered ... .

A: What does your company do exactly?

**B: It is engaged in ... . I hope I'll gain a good practical experience.**  
Are there any interesting opportunities in your research career?

A: Sure. There is an opportunity to get an academic ... but you know the most important thing for me is ... .

B: I see. Good luck in your research!

A: Thanks a lot. See you soon.

Exercise 3.

Many engineering students have a part-time job. It enables them to get practical experience and earn some money. Discuss this issue with your partner.

You can begin like this:

A: *You know, some of my friends have a part-time job. Do you?*

B: *No, not yet. But I'm planning ... . It's not an easy thing, you know.*

A: *Sure ... . You can apply to the Students' Union. They offer...*

Exercise 4.

Translate the sentences below into English.

1. Каждый факультет предлагает студенческие и аспирантские учебные программы для подготовки высококвалифицированных инженеров и молодых ученых.

2. Студентов поощряют в развитии потребности непрерывного обучения, чтобы быть конкурентно способными в быстроменяющемся технологическом мире.

3. Все инженерные курсы ориентированы на промышленность, поэтому студентов регулярно посылают на производственную практику.

4. Практический опыт – это одно из главных условий (requirement) для того, чтобы найти хорошую работу в различных отраслях промышленности.

5. Все студенты последнего курса выполняют индивидуальный исследовательский проект, который основывается на теоретическом и практическом анализе исследуемой проблемы.

6. Многие преподаватели факультета имеют ученые степени и проводят практико-ориентированную исследовательскую работу.

7. Все факультеты играют важную роль в подготовке нового поколения инженеров и ученых и активно сотрудничают с промышленными предприятиями.

8. Инженерное образование в БНТУ – это отличная база для успешной карьеры в крупных промышленных компаниях.

## UNIT 6 *The Industry of Belarus*

### STARTING UP

Exercise 1.

Think of one Belarusian brand in each of these categories

Vehicles, household appliances, food, clothing, construction materials

Exercise 2.

Study the list of goods made in Belarus. Which of them do you or members of your family make use of? Why?

Footwear, bags, fridges, microwave ovens, cookers, cotton (flax, woolen) clothes, freezers, tableware, cosmetics, TV-sets, bicycles, furniture, construction materials, confectionery, washing machines, meat and milk products.

Useful language

*High(good)-quality, reliable, energy-efficient, fully automatic, practical, cheap, stylish, well-made, tasty, value-for-money (стоит своих денег), user-friendly (удобный для пользователя), hardwearing (износостойкий), economical*



Use the model: *My family make use of an LCD TV-set made in Belarus because it's reliable. I often buy the Belarusian meat products because they are tasty.*

Exercise 3.

Do you agree or disagree with these statements? Give reasons for your answers.

1. A number of Belarusian products is world-known for their high quality.

2. **The geographic location of Belarus benefits country's economic development.**

VOCABULARY

Exercise 1.

Match the English words (phrases) with their Russian equivalents.

1) Gross Domestic Product	a) грузовой автомобиль с откидными бортами
2) household appliance	b) панель приборов
3) roll off the assembly line	c) машинное оборудование
4) extractive industry	d) черная металлургия
5) payload capacity	f) обрабатывающая промышленность
6) drop-side truck	g) седельный тягач
7) challenge	h) металлокорд
8) output	i) топливный мазут
9) machinery	j) сходить с конвейера (сборочной линии)
10) manufacturing industry	k) интегральная схема
11) dashboard	l) грузоподъемность
12) mining dump truck	m) внутренний валовой продукт (ВВП)
13) performance	n) сложная задача
14) steel cord	o) добывающая промышленность
15) labour force	p) продукция, выпуск изделий

16) integrated circuit	q) <b>выполнение</b>
17) fuel oil	r) <b>бытовой прибор</b>
18) fifth-wheel tractor	s) <b>рабочая сила</b>
19) iron and steel industry	t) <b>карьерный самосвал</b>

Exercise 2.

Match the words (phrases) to their definitions. Check any unknown words in a dictionary.

Payload capacity, assembly line, output, high-tech, mining, refinery, enterprise, energy-efficient, Gross Domestic Product

- a. a system for making things in a factory in which the products move past a line of workers who each make or check one part
- b. a company, organization or business
- c. the total value of goods produced and services provided in a country during one year
- d. the work or industry of getting gold, coal etc. out of the earth
- e. maximum amount of goods or passengers that can be carried by a vehicle
- f. using the most modern machines and methods in industry, business etc.
- g. working without wasting energy
- h. the amount of goods or work produced by a person, machine, factory etc.
- i. a factory for the purification of some crude material, such as ore, sugar, oil, etc.

Exercise 3.

Match the words with a similar meaning.

1. to deliver	a. equipment
2. customer	b. to produce
3. plant	c. manufacturer
4. machinery	d. energy efficient
5. complicated	e. petrol

6. production	f. consumer
7. energy-saving	g. zone
8. to manufacture	h. to supply
9. gasoline	i. workforce
10. area	j. complex
11. producer	k. works
12. labour force	l. output

Exercise 4.

Match the words that go together. Check that you know the meanings of the phrases. Then complete the sentences below.

1. raw	a. fertilizer
2. assembly	b. award
3. potash	c. bulbs
4. wheeled	d. materials
5. payload	e. maker
6. energy saving	f. circuits
7. correspond	g. line
8. tire	h. tractors
9. win	i. capacity
10. integrated	j. the requirements

1. A new Fiat rolls off the ... in Poland every 90 seconds.
2. Mogilev Steel Works manufactures competitive products which ... of the Belarusian and foreign customers.
3. **Manufacturing is the transformation of ... into finished products.**
4. Goodyear is Europe's second largest ... .
5. ... is a rich source of potassium and an effective means to improve crop rates.
6. **An ... otherwise known as a chip is a small electronic device made out of a semiconductor material.**
7. **The ... of an SUV (Sport Utility Vehicle) is between a truck and a car.**
8. Belarus exports a wide range of agricultural machinery including combine harvesters, ... , potato planters and potato diggers.
9. You can save up to 80% in home energy costs by using ... .

10. **When you ... an industry ... you're seen as a stable and high-quality company.**

## READING

### Exercise 1.

Before you read the text discuss the following questions.

1. What are the most developed branches of Belarusian industry from your point of view?
2. What are the most valuable products of Belarusian industry in your opinion?
3. What industrial cities of Belarus do you know?

### Exercise 2.

Go through the text to find this information:

- a) the number of people employed in the Belarusian industry
- b) payload capacity of the Belarusian mining dump trucks
- c) the biggest producer of mineral potash fertilizers in Belarus
- d) MAZ vehicles
- e) the leaders of electrical engineering industry
- f) **'Naftan'** products
- g) the location of the Belarusian Steel Works

### Exercise 3.

Read the text carefully. Then discuss the questions below.

1. How is industry defined?
2. What is the share of the **Belarusian industry in the country's GDP?**
3. What are the leading sectors of mechanical engineering?
4. What does the Belarusian Autoworks specialize in?
5. What industries is the production of BeLAZ used in?
6. What is Minsk Automobile Plant famous for?
7. Which enterprises are engaged in tractor and agricultural engineering?
8. Which position does Minsk Tractor Works rank in a list of the largest wheeled tractors exporters?
9. What does radio-electronic industry of Belarus produce?
10. What industry manufactures power transformers, energy- saving bulbs, lifts and lifting equipment?
11. What high-tech product does BMZ produce?

12. Why is the Belarusian Steel Works considered to be one of the largest exporters in Belarus?
13. **What is the structure of ‘Belaruskaliy’?**
14. What do the leading enterprises of chemical and petrochemical industry produce?
15. **What are the customers’ requirements to the Belarusian production?**
16. What should manufacturers do in order to produce market successful products?

### *The Industry of Belarus*

Industry is the key element in the economic development of any country. Industry is defined as the large-scale production of goods from raw materials. This sector of economy is divided into extractive and manufacturing industries, covering a wide range of branches. The Belarusian industrial sector accounts for nearly 32% of the Gross Domestic Product (GDP) and employs nearly 1 million people (25% of the Belarusian labour force).

Mechanical engineering and metalworking are the largest and most developed branches of the Belarusian industry. The leading sectors of mechanical engineering are automotive industry, tractor and agricultural engineering and a range of allied high-tech industries like radio-electronics, electrical engineering, instrumentation engineering and optical-mechanical industry.

Belarus specializes in truck manufacturing. The Belarusian Auto-works (BELAZ) is a major world manufacturer of mining dump trucks with payload capacity from 25 to 360 tons, as well as the other heavy vehicles, being used in mining and construction branches. The products of BELAZ are supplied to more than 70 countries of the world.

Minsk Automobile Plant has won recognition of its vehicles not only in Belarus but also far beyond. Fifth-wheel tractors, drop-side trucks, buses, chassis under installation of various special equipment roll off the assembly line under MAZ trademark. Modern design along with high level of performance allows MAZ vehicles to compete with the world producers.

37 enterprises are engaged in tractor and agricultural engineering. The largest of them are Minsk Tractor Works, ‘**Gomselmash**’, ‘**Lidselmash**’, Minsk Motor Plant, and Minsk Bearing Plant. At present

Minsk Tractor Works ranks among the eight largest exporters of wheeled tractors in the world. The enterprise takes leading positions on the markets of more than 60 countries.

**A number of companies like ‘Horizont’, ‘Atlant’, ‘Integral’, Instrument-making plant ‘Izmeritel’** dominate in radio-electronics, producing household appliances, consumer electronics, integrated circuits, semiconductor devices, dashboards for trucks, taximeters and other products.

In optical-mechanical industry **‘BelOMA’** company is particularly successful in the manufacturing of optical and laser products, aerospace and military equipment.

The enterprises of electrical engineering industry produce power transformers and transformer substations, lifts and lifting equipment, incandescent and energy-saving bulbs, and more. The leaders of this branch are **Minsk Electrotechnical Plant**, **‘Mogilevliftmash’** Works, Brest Electric Lamp Plant and others.

**The Belarusian Steel Works (BMZ) in Zhlobin is one of the world’s** leaders of iron and steel industry. The plant produces such a complicated and high-tech product as steel cord for global tire makers. About 85 % of its manufacturing output is exported to Russia, Poland, Germany, Sweden, the USA, the UK and other countries. The plant has won many national and international awards for its high quality products.

Chemical and petrochemical industry is formed by 70 enterprises of **the Belneftekhim Concern**. **‘Belaruskaliy’** is one of the biggest producers of mineral potash fertilizers in the world. There are six mines with the factories to produce potash fertilizers in the industrial area of Soligorsk. The production of **‘Belaruskaliy’** is delivered to Europe, East Asia, South and North America – in total to more than 50 countries. **Mozyr Refinery** and **‘Naftan’** produce fuel oil, gasoline, diesel fuel and other petrochemicals. **‘Belshina’** is one of the largest enterprises in Europe, making over 200 nominal sizes of tires for cars, trucks, buses, tractors and agricultural machinery. **‘Grodno Azot’** is a major manufacturer of polyamide yarns and fibers in Belarus.

**Today’s manufacturers face great challenges. Their production must be competitive, reliable and safe, corresponding to the customers’ requirements.** To ensure marketplace success they need to increase efficiency and improve their industrial performance. This can be achieved

with the use of innovative technologies and flexible, energy-saving production processes.

## SKILLS

### Exercise 1.

Match the companies to the products they manufacture. Think of adjectives that match the products.

Use the model: *The Belarusian Autoworks is the company that manufactures (produces, makes) reliable mining dump trucks.*

Company	Describing adjective	Product
Minsk Automobile Plant	well-made	fuel oil, gasoline, diesel fuel
Instrument-making plant 'Izmeritel'	reliable	power transformers, transformer substations
Minsk Motor Plant	high-quality	integrated circuits, semiconductor devices
'Naftan»' OJSC	competitive	incandescent bulbs, energy-saving bulbs
'Integral' JSC	high-tech	fridges, freezers, automatic washing machines
Minsk Bearing Plant	high-performance	fifth-wheel tractors, drop-side trucks, buses, chassis
Minsk Electrotechnical Plant	safe	dashboards for trucks, taximeters, relay-brakers
Brest Electric Lamp Plant	good-quality	diesel engines
'Atlant' CJSC	excellent	ball bearings, spherical roller bearings

OJSC – Open Joint Stock Company – **Открытое Акционерное Общество (ОАО)**

CJSC – Closed Joint Stock Company – **Закрытое Акционерное Общество (ЗАО)**

PA – Production Association – **Производственное Объединение**

### Exercise 2.

Work in pairs. Your **friend has just read the text** ‘The Industry of Belarus’. Interview him about one of the leading branches of national economy (automotive engineering, tractor and agricultural engineering, radio-electronics, electrical engineering, chemical and petrochemical industry). Ask about:

- the leading enterprises in this sector ...
- the kinds of products the industry specializes in ...
- if the companies produce competitive products ...
- where the manufacturing output is exported ...

#### Useful Language

*Do you happen to know...*

*As far as I know...*

*I wonder if...*

*If I'm not mistaken...*

*I'd like to know (if)...*

*If I remember right...*

*Could you possibly tell me...*

*It seems to me...*

*One more question to you...*

*Let me think...*

Use the model:

- *Could you tell me what kinds of products light industry specializes in?*
- *If I'm not mistaken it specializes in clothes made of cotton, flax and wool.*

### Exercise 3.

Have you ever been inside a factory? Describe what you saw and **your general impressions. If you haven't** been there yet describe what happens in the different areas of the factory using your general knowledge. Use expressions from the Useful language box to help you.

#### Useful language

*A typical factory includes (consists of)..., to be located, to be situated in an industrial zone, the main production area (line), a machine hall (workshop), an assembly shop, a warehouse, a packing line,*



*the gatehouse, large machinery, production process is fully (partially) automated, to roll off the assembly line, the conveyor belt transports goods around the factory, to run at full (half) capacity, some of the work is still done manually, to pack by hand, to wrap and load onto pallets*

Exercise 4.

Put the words in these questions in the correct order. Then match them with the answers to make a dialogue.

1. your / does / exactly / what / do / company?
2. kind / are / company / what / of / you?
3. are / markets / your / biggest / where?
4. do / many / plants / you / how / have?
5. company / people / employ / your / many / does / how?
6. has / long / in / how / been / business/ the company?
7. business / well/ going / is?

a. We export to Eastern Europe. Our domestic market accounts for about 40% of our total sales.

b. We manufacture electric generators for hospitals and small factories. We are among the largest in the country.

c. Yes it is, the company is doing well. It has a growing position in the market.

d. **We're a Joint Stock Company.**

e. We have over 500 employees.

f. For over thirty years. The original company – NT Engineering – was founded in 1981.

g. We have five domestic plants and a number of technical support centers across Europe.

Exercise 5.

**Role-play. Work in pairs. Student A: company's executive. Student B: interviewer.** You are discussing the company Student A works for. Use the notes below and expressions from Exercises 2 and 4 to prepare for the conversation.

Company	Company's history	Products	Workforce	Markets
BeLAZ OJSC	1946 – the year of foundation; 1950 – the first trucks were produced	Mining dump trucks, special purpose vehicles, road building equipment	12000 people; four domestic plants	25% of the world mining dump trucks market, 70 countries, the largest consumers are Russia and the Ukraine
Minsk Tractor Works PA	1946 – the year of foundation; 1953 – the first wheeled tractors were produced	Wheeled tractors, caterpillar tractors, municipal vehicles, forestry vehicles, mini-tractors	30000 people, 8 domestic factories, technical support centers all over the world	10% of the world wheeled tractors market, 60 countries, such as Russia, the Ukraine, China, India
Belshina OJSC	1965 – the year of foundation; 1972 – the first tires were produced	Tires for cars, trucks, buses, tractors and agricultural machinery	12000 people	Russia, Europe, Middle East, North and South America
BMZ PA	1982 – the year of foundation; 1984 – the first steel products were made	Steel cord, pipes, cast-iron casting, wire production	12000 people, 3 domestic plants	Russia, Poland, Germany, Sweden, the USA

BelOMA OJSC	1957 – the year of foundation	Optical and opto-electronic devices, lenses, loupes, night vision devices	More than 1000 people	Russia, Germany, China, the USA, domestic consumers
Minsk Motor Plant PA	1963 – the year of foundation	Diesel engines for cars, buses, tractors, dump trucks	2000 people, 6 domestic plants	Russia, the Ukraine, domestic consumers such as MAZ, BELAZ, Minsk Tractor Works
Minsk Automobile Plant OJSC	1944 – the year of foundation; 1947 – the first trucks were produced	Fifth-wheel tractors, drop-side trucks, buses, chassis	26000 people, 7 domestic plants, technical support centers all over the world	More than 30 countries the largest consumers are Russia and CIS-countries, Eastern European countries

Exercise 6.

Translate the sentences below into English.

1. Самый большой карьерный самосвал грузоподъемностью 360 тонн сошел с конвейера на Белорусском автозаводе в 2010 г.

2. Грузовики МАЗ, тракторы «Беларус», карьерные самосвалы БЕЛАЗ оснащены панелями приборов, которые произведены заводом «Измеритель» в Новополоцке.

3. Минский автомобильный завод поставляет свою продукцию во многие страны мира.

4. Колесные тракторы под торговой маркой «Беларус» конкурируют с мировыми производителями на рынках 60 стран.

5. – Какие высокотехнологичные продукты выпускаются белорусскими предприятиями?

6. – Насколько я знаю, Белорусский металлургический завод производит высокотехнологичный металлокорд, который используется в производстве шин. Компания «Интеграл» особенно успешна в производстве интегральных схем и полупроводниковых устройств.

7. Замена одной традиционной лампы накаливания на энергосберегающую сэкономит ваши деньги в расходах на электричество.

8. – Какие белорусские компании заняты в производстве бытовой техники?

9. – Ряд компаний, таких как «Горизонт», «Атлант» являются лидерами в этой области, обеспечивая отечественных потребителей изделиями хорошего качества.

10. Калийные удобрения, различные виды топлива, шины, полиамидные нити и волокна являются конкурентно-способными продуктами химической и нефтехимической отрасли.

11. Крупные белорусские производители внедряют систему менеджмента качества, которая позволяет контролировать каждый этап производства и достигать желаемого качества, чтобы соответствовать требованиям покупателей.

#### Exercise 7.

Choose a Belarusian manufacturing company. Work with your partner and prepare a five-minute presentation about the company, including the tips below:

- company history
- company size
- products and markets
- quality improvement activities

You can visit the company website to help you.

Give your presentation to the class.

## Contents

	page
Unit 1 Higher Engineering Education in Belarus	3
Unit 2 Higher Education in Great Britain	11
Unit 3 The Belarusian National Technical University	21
Unit 4 The University of Manchester	33
Unit 5 My Faculty	43
Unit 6 The Industry of Belarus	52

Учебное издание

ВАНИК Ирина Юрьевна  
ЛЯХЕВИЧ Елена Генриховна  
ЛАПКО Олеся Александровна  
СУРУНТОВИЧ Наталья Викторовна

МЕТОДИЧЕСКОЕ ПОСОБИЕ ПО ОБУЧЕНИЮ УСТНОЙ РЕЧИ  
ДЛЯ СТУДЕНТОВ ТЕХНИЧЕСКИХ ВУЗОВ

Технический редактор  
Компьютерная верстка Е.Г. Ляхевич

---

Министерство образования Республики Беларусь  
Белорусский национальный технический университет  
Кафедра английского языка №1

Боярская А.О.  
Симонова С.Д.  
Слесаренок Е. В.

**Пособие**  
**по практическому курсу научно-технического**  
**перевода для студентов технических специаль-**  
**ностей автотракторного факультета**

Минск 2006

УДК 82.035=2(075.8):62  
ББК 81.2Англ-7  
Б86

**Рецензенты:**

старший преподаватель кафедры делового английского языка БГЭУ  
Л. И.Василевская;  
зав. кафедрой английского языка №1 БНТУ, кандидат  
филологических наук, доцент, С.А. Хоменко;  
зав. кафедрой «Автомобили» БНТУ, доктор технических наук,  
профессор О.С. Руктешель;  
кандидат технических наук, доцент кафедры «Автомобили» БНТУ  
В.Г.Иванов.

**Боярская, А. О.**

Пособие по практическому курсу научно-технического перевода для студентов технических специальностей автотракторного факультета/ А. О. Боярская, С. Д.Симонова, Е. В.Слесаренок. – Мн.: БНТУ, 2006. – 104 с.

ISBN 985-479-480-6

Пособие включает 12 разделов, в которых рассматриваются лексические и грамматические аспекты перевода, аутентичные научно-технические тексты, направленные на формирование навыков перевода.

Предназначается для спецкурса по техническому переводу для студентов автотракторного факультета.

УДК 82.035=2(075.8):62  
ББК 81.2Англ-7

ISBN 985-479-480-6

© Боярская А.О., Симонова С.Д.,  
Слесаренок Е.В., 2006  
© БНТУ, 2006



## Предисловие

Данная работа является практическим пособием по обучению переводу научно–технической литературы с английского языка на русский студентов автотракторного факультета по техническим специальностям: двигатели внутреннего сгорания; автомобилестроение; тракторостроение; многоцелевые колесные и гусеничные машины; городской электрический транспорт; техническая эксплуатация автомобилей; автосервис; гидропневмосистемы мобильных и технологических машин. Пособие рассчитано на 36 часов.

Цель пособия - развить умение анализировать различные элементы текста и правильно переводить американскую и английскую научно–техническую литературу по специальности, а также привить навыки аннотирования и реферирования текстов.

Учебное пособие состоит из 12 разделов, приложения по аннотированию и реферированию научно-технического текста и дополнительных текстов для перевода. Каждый раздел включает учебный текст с работками и дополнительный текст для письменного перевода.

Текстовый материал представлен аутентичными текстами, содержащими информацию по техническим характеристикам автомобиля и его эксплуатации.

Упражнения, включенные в уроки, отражают лексические и грамматические особенности перевода. В систему лексических упражнений входят упражнения на перевод терминологической лексики, многофункциональных слов. Упражнения на словообразование ставят целью научить студента переводить слова, в состав которых входят префиксы и суффиксы, часто встречающиеся в научно – технической литературе.

В систему грамматических упражнений входят упражнения на перевод страдательного залога, инфинитива и инфинитивных конструкций, причастия и причастных оборотов, герундия, эмфатических конструкций и др. В каждый раздел включен поурочный словарь, составленный из наиболее трудной лексики текстового материала.

Разделы пособия представляют собой самостоятельную часть курса перевода, что дает возможность изменять последовательность изучения отдельных разделов.

В пособие включены тексты из оригинальных журналов по специальности. Эти тексты рассчитаны на развитие навыков работы с политехническим и отраслевым (по данной узкой специальности) словарем.

## Unit 1

### Basic Features of an Engine

#### **Упр. 1. Запомните новые слова и выражения и их значения.**

1. burn (v) - сгорать, сжигать
2. combustion chamber - камера сгорания
3. connecting rod - шатун, соединительная тяга
4. convert (v) - превращать, преобразовывать
5. core - сердцевина, сердечник
6. crankshaft - коленчатый вал
7. displacement - рабочий объем (цилиндров) двигателя
8. four-stroke - четырехтактный
9. jack-in-the-box - дифференциал
10. jumble - куча, мешанина, беспорядочная смесь
11. hood - крышка капота (двигателя)
12. ignite (v) - поджигать, воспламенять
13. internal combustion engine (ICE) - двигатель внутреннего сгорания
14. oil pan - поддон
15. piston - поршень
16. piston rings - поршневые кольца
17. reciprocating internal combustion engine - поршневой двигатель внутреннего сгорания
18. release (v) - высвобождать
19. rotate - вращаться
20. seal – уплотнение; сальник
21. set off(v) - запустить
22. smooth – гладкий, ровный
23. spark plug - свеча зажигания
24. sump - поддон (картера)
25. valve - клапан

#### **Упр. 2. Прочтите и переведите интернациональные слова.**

Diesel, efficient, equivalent, typical, energy, form, gas, cycle, compression, to start, to plan, multi-cylinder, horizontally, configuration, motor-cycle, sports car, normal, liter, number, indicator, battery, compact, material.

**Упр. 3. Переведите предложения на русский язык обращая, внимание на новые слова.**

1. Almost all cars today have a four-stroke combustion cycle to convert gasoline into motion. 2. Almost all cars today use a reciprocating internal combustion engine. 3. You can get more displacement in an engine by increasing the number of cylinders. 4. If you put a tiny amount of high-energy fuel in an enclosed space and ignite it, an incredible amount of energy is released in the form of an expanding gas. 5. The combustion chamber is the area where compression and combustion take place. 6. Piston rings provide a sliding seal between the outer edge of the piston and the inner edge of the cylinder. 7. The piston is connected to the crankshaft by a connecting rod.

**Упр. 4. Переведите выделенные слова на английский язык, используя активный словарь урока.**

1. (Поддон) contains some amount of oil. 2. The (рабочий объем) tells you something about how much power an engine can produce. 3. When the (поршень) reaches the top of its stroke, the (свеча зажигания) emits a spark to (воспламенить) the gasoline. 4. A car engine can look like a big confusing (мешанина) of metal, tubes and (проводов) 5. It can (вращается) at both ends so that its angle can change as the piston moves and the (коленчатый вал) (вращается). 6. (Поршневые кольца) keep oil in the (поддоне картера) from leaking into the combustion area, where it would be burned and lost. 7. (Сердцевина) of the engine is the cylinder, with the piston moving up and down inside the cylinder.

**Упр. 5. Выберите правильное определение для каждого данного слова и переведите их на русский язык.**

jumble, piston, hood, core, wire, plug, combustion

1. the metal cover over the engine of a motor car (protective cover over the engine of a motor car).
2. piece or length of metal in the form of a thread.
3. a lot of different things mixed together in an untidy order, without any order.
4. chemical activity which uses oxygen to produce light and heat.
5. central or most important part of anything (of an engine).

6. a part of an engine consisting of a short solid piece of metal inside a tube, which moves up and down.
7. the part of a petrol engine that makes spark, which makes the petrol start burning.

**Упр. 6. Выберите правильный перевод словосочетаний, где слово "ENGINE" является определяющим.**

- |                               |  |
|-------------------------------|--|
| 1. boxer engine               | a) четырехтактный двигатель  |
| 2. centrally mounted engine   | b) двигатель с высокими эксплуатационными характеристиками               |
| 3. crank engine               | c) двигатель с верхним расположением клапанов                            |
| 4. flat engine                | d) двигатель с противоположащими (оппозитными) цилиндрами                |
| 5. flat twin engine           | e) кривошипно-шатунный двигатель   |
| 6. four-stroke engine         | f) двигатель без наддува   |
| 7. in-line engine             | g) двигатель, расположенный в середине базы                              |
| 8. naturally aspirated engine | h) двигатель с горизонтально расположенными цилиндрами                   |
| 9. overhead valve engine      | i) двигатель с двумя горизонтально расположенными оппозитными цилиндрами |
| 10. reciprocating engine      | j) поршневой двигатель с кривошипно-шатунным механизмом                  |
| 11. supercharged engine       | k) однорядный двигатель  |
| 12. turbocharged engine       | l) газотурбинный двигатель   |
| 13. gas-turbine engine        | m) двигатель с турбонаддувом   |
| 14. high-performance engine   | n) двигатель с наддувом  |

**Упр. 7. Переведите предложения на русский язык, обращая внимание на употребление многофункционального слова “one”.**

1. The annual Geneva Motor Show is one of the best automotive delights of the year. 2. The automotive test platform gives engineers one platform for multiple tests. 3. One of the particular areas of research concerns the interaction between the tyre and the road surface. 4. One of the most important things for the driver to know is how to keep the speed. 5. Many sensors are interconnected and their output is used for more than one vehicle system. 6. Among possible sources of power for engines one has to consider the possibility of applying atomic energy.

**Упр. 8. Переведите предложения на русский язык, обращая внимание на сложные предлоги.**

1. The most famous act was the Red Flag Act of 1865, according to which the speed of the steam-driven vehicles was limited to 4 miles per hour and a man with a red flag had to walk in front of it. 2. In case of mechanical stabilization granular or cohesive materials are added to the subsoil. 3. Scania has achieved its position amongst European bus builders due to its safety, economy, quality and service. 4. In addition to quality assurance the company offers its customers extensive international aftersale service network. 5. Jaguar was forced to consider producing its own station wagon model because of main competitors.

**Упр. 9. Переведите предложения на русский язык, обращая внимание на перевод сказуемого.**

1. Dual-stage front airbags have been introduced on this model. 2. The basic specification level includes ABS braking and an emergency braking system. 3. The plant will be producing 1,000 cars a year. 4. Honda has also added a triple cone synchronizer between first and second gear. 5. The BMW X-5 off-road sports car, which appeared several years ago, has undergone its first comprehensive upgrade with a focus on improving performance and safety features. 6. Increased power has reduced the acceleration time and slightly increased the top speed. 7. The new Eclipse Sport Coupe will hit the market two weeks before the schedule. 8. New Eclipse cars have already appeared at motor shows and G8 version starts at \$20,000.

**Упр. 10. Переведите предложения на русский язык, обращая внимание на перевод инфинитива.**

1. The purpose of a gasoline car is to convert gasoline into motion. 2. The easiest way to create motion from gasoline is to burn the gasoline inside an engine. 3. The fuel in a steam engine burns outside the engine to create steam. 4. When the piston reaches the top of its stroke, the spark plug emits a spark to ignite the gasoline. 5. The spark must happen at the right moment for things to work properly. 6. The intake and exhaust valves open at the proper time to let in air and fuel and to let out exhaust. 7. First the piston moves down to let the engine take in a cylinder - full of air and gasoline, <sup>then</sup> the piston moves back up to compress this fuel/air mixture. 8. The main aim of the piston rings is to prevent the fuel/air mixture from leaking into the sump during compression and combustion.

**Упр. 11. Заполните таблицу, образуя указанные части речи, и переведите их.**

VERB	NOUN	ADJECTIVE
move	...	...
...	ignition	...
...	...	useful
connect	...	...
...	mixture	...
compress	...	...
...	...	rotational
...	displacement	....
...	leakage	...
increase	....	...

**Упр. 12. Прочитайте и переведите текст. Пополните свой словарь терминов по изучаемой специальности.**

Have you ever opened the hood of your car and wondered what was going on in there? A car engine can look like a big confusing jumble of metal, tubes and wires. You might want to know what's going on or perhaps you are buying a new car.

The purpose of a gasoline car engine is to convert gasoline into motion so that your car can move. The easiest way to create motion from

gasoline is to burn the gasoline inside an engine. Therefore, a car engine is an internal combustion engine - combustion takes place internally. Two things to note:

1. There are different kinds of internal combustion engines. Diesel engines are one form and gas turbine engines are another. Each has its own advantages and disadvantages.

2. There is such a thing as an external combustion engine. A steam engine in old-fashioned trains and steamboats is the best example of an external combustion engine. The fuel (coal, wood, oil, whatever) in a steam engine burns outside the engine to create steam, and the steam creates motion inside the engine. Internal combustion is a lot more efficient (takes less fuel per mile) than external combustion, plus an internal combustion engine is a lot smaller than an equivalent external combustion engine.

Almost all cars today use a reciprocating internal combustion engine because this engine is relatively efficient, relatively inexpensive and relatively easy to refuel.

#### Internal Combustion

If you put a tiny amount of high-energy fuel (like gasoline) in a small, enclosed space and ignite it, an incredible amount of energy is released in the form of expanding gas. For example, if you can create a cycle that allows you to set off explosions like this hundreds of times per minute, and if you can use that energy in a useful way, what you have is the core of a car engine!

Almost all cars currently use what is called a four-stroke combustion cycle to convert gasoline into motion. The four-stroke cycle is also known as the Otto cycle, in honor of Nikolaus Otto, who invented it in 1867. They are - intake stroke, compression stroke, combustion stroke and exhaust stroke.

#### Understanding the Cycles

The piston is connected to the crank shaft by a connecting rod. Here's what happens as the engine goes through its cycle:

The piston starts at the top, the intake valve opens, and the piston moves down to let the engine take in a cylinder-full of air and gasoline. This is the intake stroke. Only the tiniest drop of gasoline needs to be mixed into the air for this to work. Then the piston moves back up to compress this fuel/air mixture. Compression makes the explosion more powerful. When the piston reaches the top of its stroke, the spark plug

emits a spark to ignite the gasoline. The gasoline charge in the cylinder explodes, driving the piston down. Once the piston hits the bottom of its stroke, the exhaust valve opens and the exhaust leaves the cylinder to go out the tail pipe. Now the engine is ready for the next cycle, so it intakes another charge of air and gas.

Notice that the motion that comes out of an internal combustion engine is rotational. In an engine the linear motion (straight line) of the pistons is converted into rotational motion by the crank shaft. The rotational motion is smooth because we plan to turn (rotate) the car's wheels with it anyway.

Now let's look at all the parts that work together to make this happen.

### Counting Cylinders

The core of the engine is the cylinder, with the piston moving up and down inside the cylinder. The engine described above has one cylinder, but most cars have more than one cylinder (four, six and eight cylinders are common). In a multi-cylinder engine, the cylinders usually are arranged in one of three ways: inline, V or flat (also known as horizontally opposed or boxer). Different configurations have different advantages and disadvantages in terms of smoothness, manufacturing-cost and shape characteristics.

### Displacement

The combustion chamber is the area where compression and combustion take place. As the piston moves up and down, you can see that the size of the combustion chamber changes. It has some maximum volume as well as a minimum volume. The difference between the maximum and minimum is called the displacement and is measured in liters or CCs (Cubic Centimeters, where 1,000 cubic centimeters equals a liter). For example: A motorcycle might have a 500 cc or a 750 cc engine, while a sports car might have a 5.0 liter (5,000 cc) engine. Most normal car engines fall somewhere between 1.5 liter (1,500 cc) and 4.0 liters (4,000 cc)

If you have a 4-cylinder engine and each cylinder displaces half a liter, then the entire engine is a "2.0 liter engine." If each cylinder displaces half a liter and there are six cylinders arranged in a V configuration, you have a "3.0 liter V-6."

Generally, the displacement tells you something about how much power an engine can produce. A 2.0 liter engine is roughly half as powerful as a 4.0 liter engine. You can get more displacement in an engine



either by increasing the number of cylinders or by making the combustion chambers of all the cylinders bigger (or both).

#### Other Parts of an Engine

**Spark Plug.** The spark plug supplies the spark that ignites the air/fuel mixture so that combustion can occur. The spark must happen at just the right moment for things to work properly.

**Valves.** The intake and exhaust valves open at the proper time to let in air and fuel and to let out exhaust. Note that both valves are closed during compression and combustion so that the combustion chamber is sealed.

**Piston.** A piston is a cylindrical piece of metal that moves up and down inside the cylinder.

**Piston rings.** Piston rings provide a sliding seal between the outer edge of the piston and the inner edge of the cylinder. The rings serve two purposes:

- They prevent the fuel/air mixture and exhaust in the combustion chamber from leaking into the sump during compression and combustion.
- They keep oil in the sump from leaking into the combustion area, where it would be burned and lost.

**Connecting rod.** The connecting rod connects the piston to the crankshaft. It can rotate at both ends so that its angle can change as the piston moves and the crankshaft rotates.

**Crank Shaft.** The crank shaft turns the piston's up and down motion into circular motion just like a crank on a jack-in-the-box does.

**Sump.** The sump surrounds the crankshaft. It contains some amount of oil, which collects in the bottom of the sump (the oil pan).

### **Упр. 13. Выполните письменный перевод следующего текста.**

In the traditional steam engine, and even in a modern steam turbine, fuel is burned outside the engine. But it is more efficient to burn fuel inside the engine and let the expanding gases produced drive a piston or turbine. The first such internal combustion engine, running on gas, was built by the German engineer Niikolaus August Otto (1832-1891). His engine, demonstrated in Paris in 1867, was large, noisy and not very efficient. But it became the forerunner of almost all today's engines. Nine years after the first gas engine Otto invented another, based on the four-stroke cycle. The crucial advance

in this engine was ignition, giving not only a considerable improvement in efficiency but also a remarkable reduction in fuel consumption. It takes four strokes of the engine to include one of power, so this system is known as the four-stroke cycle. It is by far the most common type of engine in use today. Many motorcycles and few small cars use the two-stroke cycle first created by Dugald Clerk in 1880.

**Упр. 14. Составьте письменную аннотацию по теме “Составляющие двигателя и их функции”, используя следующие выражения:**

The text deals with ... . Attention is drawn to the fact that ... . It is pointed out that ... . It should be noted that ... . I find the text rather/very ... .

## Unit 2

### What Can Go Wrong

**Упр. 1. Запомните новые слова и выражения и их значения.**

1. attach (v) - прикреплять
2. bearing - подшипник
3. clog(v) - забиваться, засоряться
4. combustion - сгорание
5. compression - сжатие, компрессия
6. crankshaft – коленчатый вал
7. cylinder head - головка цилиндра
8. exhaust - выхлоп
9. gasket- прокладка
10. hole -отверстие, дыра
11. impurity – загрязнение, примесь
12. lack (n) - отсутствие, нехватка
13. leak (v) - протекать
14. occur (v) - случаться, происходить
15. run-down - краткое изложение, обзор
16. seal (v) - изолировать, уплотнить
17. spark - искра

**Упр. 2. Прочтите и переведите интернациональные слова.**

Compression, system, cylinder, battery, technology, physical, chemical, problem, electromagnetic, progress, transmission, signal, period, centre, radar, serious, temperature, negative, test, filter.

**Упр. 3. Переведите предложения на русский язык обращая, внимание на новые слова.**

1. The most common "hole" in a cylinder occurs where the top of the cylinder (holding the valves and spark plug also known as the cylinder head) attaches to the cylinder head. 2. Three fundamental things can happen: a bad fuel mix, lack of compression or lack of spark. 3. The fuel system might be supplying too much or too little fuel to the mix, meaning that combustion does not occur properly. 4. The spark might be nonexistent or weak for a number of reasons. 5. Three renewable bearings located directly in the cylinder block support the camshaft. 6. The cylinder and the cylinder head bolt together with a thin gasket pressed between them to ensure a good seal. 7. If the valves do not open and close at the right time or at all, air cannot get in and exhaust cannot get out, so the engine cannot run.

**Упр. 4. Переведите выделенные слова на английский язык, используя активный словарь урока.**

1. There might be an (загрязнение) in the fuel (like water in your gas tank) that makes the fuel not burn. 2. The air intake might be (засорено), so there is fuel but not enough air. 3. Your piston rings are worn allowing air/fuel to (протекать) past the piston during compression. 4. The intake or (выхлопной) valves (не изолированы) properly, again (позволяя) a leak during compression. 5. If the (прокладка) breaks down, small (отверстия) develop between the cylinder and the (голова цилиндра), and this (отверстия) cause (утечки). 6. If the wire is cut or missing, there will be no (искры). 7. If the (подшипники) that allow the (коленчатый вал) to turn freely are work out, the (коленчатый вал) cannot turn so the engine cannot run.

**Упр. 5. Выберите правильное определение для каждого данного слова и переведите их на русский язык.**

gasket, bearing, run-down, pipe, to clog, spark.

1. reduction; detailed explanation or listing.

2. be or become blocked with waste matter, dirt, so that movement, flow of liquid is difficult or prevented.
3. flat piece of material often rubber, placed between two surfaces so that the steam, gas cannot escape.
4. flash of light caused by electricity passing across a space.
5. in a machine - device that supports moving parts and reduces friction.
6. tube through which liquids or gases can flow.

**Упр. 6. Выберите правильный перевод словосочетаний, где слово "SYSTEM" является определяющим.**

- |  |   |
|--|---|
| 1. air brake system                    | a) автоматическое устройство для поддержания заданной скорости автомобиля |
| 2. window cleaning system              | b) герметизированная система  |
| 3. brake system                        | c) пневматическая тормозная система                                       |
| 4. brakeless ignition system           | d) аварийная тормозная система  |
| 5. capacitor discharge ignition system | e) система зажигания с емкостным разрядом                                 |
| 6. cruise control system               | f) тормозная система  |
| 7. emergency brake system              | g) бесконтактная система зажигания  |
| 8. monitoring system                   | h) система клапанов   |
| 9. sealed system                       | i) система очистки стекла   |
| 10. valve system                       | j) система контроля   |

**Упр. 7. Переведите предложения на русский язык, обращая внимание на перевод многофункционального слова "like".**

1. Like the radio and telephone, the information shown in the central display is controlled by keys on the multi-function steering wheel. 2. Like the steering column, the redesigned front seats are electrically adjustable, including a memory function. 3. There are about 3,000 Americans who like to collect antique cars. 4. Like most other great human achievements, the motor cars is not the product of any single inventor. 5. The operation performed is like this: when taken in the cylinder the air is

highly compressed, the temperature rises so the heated fuel-air mixture burns. 6. A car engine looks like a big, confusing jumble of metal, tubes and wires. 7. The hybrid car has a gasoline engine much like the one you will find most cars.

**Упр. 8. Переведите предложения на русский язык, обращая внимание на перевод глаголов с предлогами, стоящими после них.**

1. The word “automobile” consists of two words autos meaning “self” and mobilis – a Latin word meaning “movable”. 2. In Japan, buses are equipped with a manually adjustable system of suspension control. 3. Most automotive engineers dealt with topics such as gasoline and diesel engines, transmissions, suspension system, chassis, etc. 4. The new five speed automatic transmission is linked to the adaptive suspension system. 5. At the present rate of production oil supplies will run out rather soon and we will have to look for other sources of energy. 6. Success of the electric car depends on light weight battery, capable of being recharged quickly, and the availability of electric energy. 7. Land Rover is often associated with African wild life.

**Упр. 9. Переведите предложения на русский язык, обращая внимание на перевод глаголов в пассивном залоге.**

1. The power output has been boosted by a supercharger. 2. Chrysler-Benz, as the new amalgam in the making is being called, would be an automotive giant. 3. Its most recent success, the Century Coach, was awarded the 1994 Coach of the Year Prize in the UK. 4. The modern automobile has often been described as a computer on wheels. 5. In the powertrain area, sensors are used to measure the temperature and pressure of most of the fluids. 6. New models are regularly subjected to a number of standardized tests which make it possible to compare results. 7. Other sensors are being added as car manufactures add side impact bags and sophisticated head protection airbags.

**Упр. 10. Переведите предложения на русский язык, обращая внимание на перевод модальных глаголов.**

1. The air intake might be clogged, so there's fuel but not enough air. 2. If you are a poor mechanic, you should stop at service station periodically. 3. If your car doesn't start, the petrol pump may be broken or the fuel

pipe may be blocked. 4. You should check the spark plugs. 5. If you failed to start the engine, you have to repair it. 6. Fuel pump can be either electric or mechanic in operation. 7. If the charge of air and fuel cannot be compressed properly, the combustion process will not work like it should. 8. If someone sticks a potato up your tailpipe, exhaust cannot exit cylinder so the engine will not run. 9. Better technologies can improve the performance of the engine.

**Упр. 11. Переведите предложения на русский язык, обращая внимание на перевод инфинитива.**

1. The task was to develop a completely new family of cars. 2. Mini and BMW have every right to feel proud. 3. But manufactures can use VTES (Visteon’s torque enhancement systems) to boost gasoline or reduce the size. 4. To improve driving control the 4-ETS is combined with the Electronic Stability Programme. 5. Karl Benz employed his own Otto-type engine to power a three-wheel carriage in 1885. 6. It is necessary to provide an automobile with a differential, in order the rear wheels to revolve at different speeds when the car turn a corner.

**Упр. 12. Заполните таблицу, образуя указанные части речи, и переведите их.**

VERB	NOUN	ADJECTIVE
save	...	...
...	...	separate
...	cooler	...
...	power	...
...	...	compressible
...	detection	...
...	adaptor	....
improve	...	...
....	creation	....

**Упр. 13. Прочитайте и переведите текст. Выпишите из текста ключевые слова и выражения для составления аннотационного перевода.**

So you go out one morning and your engine will turn over but it won't start... What could be wrong? Now that you know how an en-

engine works, you can understand the basic things that can keep an engine from running. Three fundamental things can happen: a bad fuel mix, lack of compression or lack of spark. Besides that, thousands of other things can create problems, but these are "the big three." Based on the simple engine we have been discussing, here is a quick run down on how these problems affect your engine.

Bad fuel mix: A bad fuel mix can occur in several ways:

- You are out of gas, so the engine is getting air but no fuel.
- The air intake might be clogged, so there is fuel but not enough air.
- The fuel system might be supplying too much or too little fuel to the mix, meaning that combustion does not occur properly.
- There might be an impurity in the fuel (like water in your gas tank) that makes the fuel not burn.

Lack of compression: If the charge of air and fuel cannot be compressed properly, the combustion process will not work like it should. Lack of compression might occur for these reasons: your piston rings are worn (allowing air/fuel to leak past the piston during compression); the intake or exhaust valves are not sealing properly, again allowing a leak during compression; there is a hole in the cylinder.

The most common "hole" in a cylinder occurs where the top of the cylinder (holding the valves and spark plug and also known as the cylinder head) attaches to the cylinder itself. Generally, the cylinder and the cylinder head bolt together with a thin gasket pressed between them to ensure a good seal. If the gasket breaks down, small holes develop between the cylinder and the cylinder head, and these holes cause leaks.

Lack of spark: The spark might be nonexistent or weak for a number of reasons:

- If your spark plug or the wire leading to it is worn out, the spark will be weak.
- If the wire is cut or missing, or if the system that sends a spark down the wire is not working properly, there will be no spark.
- If the spark occurs either too early or too late in the cycle (i.e. if the ignition timing is off), the fuel will not ignite at the right time, and this can cause all sorts of problems.

Many other things can go wrong. For example:

- If the battery is dead, you cannot turn over the engine to start it.
- If the bearings that allow the crankshaft to turn freely are worn out, the crankshaft cannot turn so the engine cannot run.
- If the valves do not open and close at the right time or at all, air cannot get in and exhaust cannot get out, so the engine cannot run.
- If someone sticks a potato up your tailpipe, exhaust cannot exit the cylinder so the engine will not run.
- If you run out of oil, the piston cannot move up and down freely in the cylinder, and the engine will seize.

In a properly running engine, all of these factors are within tolerance.

As you can see, an engine has a number of systems that help it do its job of converting fuel into motion. Most of these subsystems can be implemented using different technologies, and better technologies can improve the performance of the engine. All different subsystems used in modern engines will be described later.

**Упр. 14. Выполните письменный перевод следующего текста.**

Unlike steam engines most internal combustion engines do not produce great power at slow speeds. The cylinders are small and each individual ignition stroke produces comparatively little power. To obtain a useful amount of work from such engine it must be run fast, to put the maximum number of ignition strokes into each second. Motor car engines commonly produce their maximum power at speeds of 5,000 revolutions per minute or more. The oscillating pistons and valve gear sets the upper limit on speed, specially prepared engines, in which great attention has been paid to balance and smoothness, thus can be obtained more power by running into speeds of 12,000 rpm or more.

**Упр.15. Составьте письменный реферат об основных проблемах, возникающих при запуске двигателя, используя следующие выражения:**

The text is about ... . It is shown that ... . In the opinion of the author it is ... . Of special interest is the fact that ... .



## Unit 3

### Subsystems of Modern Engines

#### **Упр. 1. Запомните новые слова и выражения и их значения.**

1. alternator – генератор переменного тока
2. approach - подход
3. bank of cylinders - блок цилиндров
4. boost – форсировка двигателя (наддув)
5. camshaft – распределительный вал
6. carburetion - образование топливной смеси
7. catalytic converter - катализатор
8. emission - выхлопы
9. exhaust pipe - выхлопная труба
10. ignition - зажигание
11. lag - запаздывание
12. lobe (n) - рабочая часть кулачка, выступ кулачка
13. lubrication - смазка
14. muffler - глушитель
15. naturally aspirated – с естественным засосом воздуха (без наддува)
16. overhead cam - верхний кулачок
17. spin (v) - вращать, крутить
18. squirt (v) - разбрызгивать тонкой струйкой
19. supercharger - нагнетатель с наддувом
20. sump - поддон картера
21. timing chain-цепь привода распределительного механизма
22. trickle (v) down - капать
23. turbocharger - турбонагнетатель
24. valve lifter – толкатель клапана
25. valve train - клапанный механизм, газораспределительный механизм (ГРМ)
26. wire - провод

#### **Упр. 2. Прочтите и переведите интернациональные слова.**

Battery, to generate, electrical system, electricity, radio, mechanism, modern, to activate, starter, transmission, distributor, radiator, to circulate, motorcycle, filter, cylinder, turbine, compressor, starter solenoid, volt, amp, electronic, cycle, individual, motor.

**Упр. 3. Переведите предложения на русский язык обращая внимание на новые слова.**

1. The valve train consists of the valves and a mechanism that opens and closes them, which is called a camshaft. 2. Many high-performance engines have four valves per cylinder and this arrangement requires two camshafts per bank of cylinders. 3. In carburetion, a device called a carburetor mixes gas into air as the air flows into the engine. 4. When you turn the ignition key, the starter motor spins the engine a few revolutions so that the combustion process can start. 5. The lubrication system makes sure that every moving part in the engine gets oil so that it can move easily. 6. The emission control system consists of a catalytic converter, a collection of sensors and actuators and some other things. 7. The electrical system consists of a battery and an alternator. 8. The oil trickles down into the sump, where it is collected again and the cycle repeats. 9. High-performance engines are either turbocharged or supercharged, which means that air coming into the engine is first pressurized to increase displacement.

**Упр. 4. Переведите выделенные слова на английский язык, используя активный словарь урока.**

1. Most modern engines have what are called (верхние кулачки). 2. This (подход) has more moving parts and also (вызывает) more (запаздывание) between the cam's activation of the (клапан) and subsequent motion of the (клапан). 3. A timing belt links the (коленчатый вал) to the (распределительный вал) so that the valves are in sync with the (поршнями). 4. The (распределитель) has one (провод) going in the center and four, six or eight (проводов) coming out of it. 5. A turbocharger uses a small turbine (прикрепленный) to the (выхлопная труба) to spin a compressing turbine in the (поток входящего воздуха). 6. The exhaust system includes (выхлопная труба) and (глушитель). 7. The (генератор переменного тока) is connected to the engine by a (ремень) any generates electricity to (перезарядить) the battery.

**Упр. 5. Выберите правильное определение для каждого данного слова и переведите их на русский язык.**

lubricate, ignition, bank, sump, carburetor, supercharger, radiator, turbocharger, starter solenoid.

1. row of cylinders in an engine.
2. electrical mechanism of a vehicle engine that makes it start working.
3. device for cooling the cylinders of the engine of a motor vehicle.
4. device used in an internal - combustion engine to force extra oxygen into the cylinders.
5. a system that makes a vehicle more powerful by using a turbine to force air and petrol into the engine.
6. a large electronic switch that can handle much current to power the motor.
7. put oil into machine parts to make them work easily.
8. that part of internal combustion engine in which petrol and air are mixed to make an explosive mixture.
9. the part of an engine that contains lubrication oil.

**Упр. 6. Образуйте подходящие словосочетания, вставьте их в предложения и переведите их на русский язык.**

1. fuel, valve, cam, ignition, starter, crank, spark, air/fuel.
2. cams, system, solenoid, shaft, lifters, wires, plugs, mixture, shaft

1. Most modern engines have what are called ... . 2. Rods linked the cam below to ... above the valves. 3. The ... is geared to turn at one-half the rate of the ... . 4. The ignition system produces a high-voltage electrical charge and transmits it to the ... via... . 5. The starting system consists of an electric starter motor and ... . 6. The ... pumps gas from the gas tank and mixes it with air so that the proper ... can flow into the cylinders.

**Упр. 7. Переведите предложения на русский язык, обращая внимание на перевод прилагательных.**

1. Henry Roys and Charlles Rolls decided to design the most comfortable and reliable car. 2. The higher the pressure, the higher the temperature. 3. Help also comes from mounting the fan on spacers and keeping it as far as possible from the engine. 4. Although STN displays are slower and more limited in viewing angle than TFT's, they are cheaper and more energy efficient. 5. A stiffer body, quieter engine and the use of sound-deadening

materials in the body provide a much quieter ride than its predecessor. 6. The new Saab 9-3 is 17mm higher and 55mm wider than the old one and has a 71mm longer wheelbase. 7. As far as paint colors are concerned “moon silver” is proving the most popular along A-Class customers.

**Упр. 8. Переведите предложения на русский язык, обращая внимание на употребление многофункционального слова “since”.**

1. The company IRIZAR was founded in 1889 and since then it has been engaged in the construction of bus work for passenger transport. 2. Since 1970 there were many brilliant inventions in the automobile industry. 3. The progress of motor cars in Great Britain was stopped since there were severe speed limits. 4. Since the French engineer Cugnot invented the first self-propelled vehicle in 1770, the automobile industry developed very rapidly. 5. Since flexibility is the ability of the engine to run smoothly, most engines perform properly at all speeds and through all variations of atmospheric conditions. 6. Ever since 1904 the trade name of Rolls-Royce has always been the perfect car.

**Упр. 9. Переведите предложения на русский язык, обращая внимание на перевод сказуемого в пассивном залоге.**

1. The camshaft is located above the valves. 2. Older engines used a camshaft which was located in the sump near the crankshaft. 3. The camshaft is geared to turn at one-half the rate of the crankshaft. 4. The engine is timed so that only one cylinder receives a spark from the distributor at a time. 5. In a few cars and in most motorcycles the engine is air-cooled. 6. A supercharger is attached directly to the engine to spin the compressor. 7. In most cars, oil is sucked out of the oil pan by the oil pump, run through the oil filter and then squirted onto bearings and the cylinder walls. 8. The piston is connected to the crankshaft by a connecting rod. 9. The difference between the maximum and the minimum volume is called the displacement and is measured in liters or Cubic Centimeters.

**Упр. 10. Переведите предложения на русский язык, обращая внимание на перевод инфинитивного оборота “сложное подлежащее”.**

1. The V5-engined car is reported to be the most powerful and luxurious Golf Estate yet available in the UK. 2. At the beginning of the 20th century a new car design seemed to be a fantasy. 3. The turbocharger market

in Europe alone is estimated to be worth at least € 1 billion a year. 4. Ford, Daimler-Benz and Ballard are expected to accelerate further the development of fuel-cell-powered components for cars and trucks. 5. The electric automobile energized by rechargeable batteries appeared to have a great future nearly a century ago. 6. Most drivers are found to have phones in their vehicles or carry phones when they drive.

**Упр. 11. Переведите цепочки однокоренных слов.**

1. create – creator – creature – creation – created – creating
2. determine – determined – determining - determination
3. recognize – recognized – recognition –recognizable
4. technology – technologist – technical – technician – technique
5. cycle - recycle – bicycle – motorcycle – recycled –recycling
6. accumulate – accumulation – accumulated – accumulating
7. consume - consumption –consumer

**Упр.12. Заполните таблицу, образуя указанные части речи и переведите их.**

VERB	NOUN	ADJECTIVE
...	...	meaningful
activate	...	...
arrange	...	...
...	linkage	...
...	performance	...
require	...	...
...	...	productive
...	...	compressive
power	...	...
explode	...	...
...	charge	...

**Упр. 13. Прочитайте и переведите абзацы об электрической системе, системах запуска и выхлопа.**

Valve Trains.

The valve train consists of the valves and a mechanism that opens and closes them. The opening and closing system is called a camshaft. The camshaft has lobes on it that move the valves up and down.

Most modern engines have what are called overhead cams. This means that the camshaft is located above the valves. The cams on the shaft activate the valves directly or through a very short linkage. Older engines used a camshaft located in the sump near the crankshaft. Rods linked the cam below to valve lifters above the valves. This approach has more moving parts and also causes more lag between the cam's activation of the valve and the valve's subsequent motion. A timing belt or timing chain links the crankshaft to the camshaft so that the valves are in sync with the pistons. The camshaft is geared to turn at one-half the rate of the crankshaft. Many high-performance engines have four valves per cylinder (two for intake, two for exhaust), and this arrangement requires two camshafts per bank of cylinders, hence the phrase "dual overhead cams."

#### Ignition System

The ignition system produces a high-voltage electrical charge and transmits it to the spark plugs via ignition wires. The charge first flows to a distributor, which you can easily find under the hood of most cars. The distributor has one wire going in the center and four, six, or eight wires (depending on the number of cylinders) coming out of it. These ignition wires send the charge to each spark plug. The engine is timed so that only one cylinder receives a spark from the distributor at a time. This approach provides maximum smoothness.

#### Cooling System

The cooling system in most cars consists of the radiator and water pump. Water circulates through passages around the cylinders and then travels through the radiator to cool it off. In a few cars (as Volkswagen Beetle) and in most motorcycles, the engine is air-cooled instead. Air-cooling makes the engine lighter but hotter, generally decreasing engine life and overall performance.

#### Air Intake system

Most cars are naturally aspirated, which means that air flows through an air filter and directly into the cylinders. High-performance engines are either turbocharged or supercharged, which means that air coming into the engine is first pressurized (so that more air/fuel mixture can be squeezed into each cylinder) to increase performance. The amount of pressurization is called boost. A turbocharger uses a small turbine attached to the exhaust pipe to spin a compressing turbine in the incoming

air stream. A supercharger is attached directly to the engine to spin the compressor.

### Starting System

The starting system consists of an electric starter motor and a starter solenoid. When you turn the ignition key, the starter motor spins the engine a few revolutions so that the combustion process can start. It takes a powerful motor to spin a cold engine. The starter motor must overcome:

- All of the internal friction caused by the piston rings
- The compression pressure of any cylinder(s) that happens to be in the compression stroke
- The energy needed to open and close valves with the camshaft
- All of the "other" things directly attached to the engine, like the water pump, oil pump, alternator, etc.

Because so much energy is needed and because a car uses a 12-volt electrical system, hundreds of amps of electricity must flow into the starter motor. The starter solenoid is essentially a large electronic switch that can handle that much current. When you turn the ignition key, it activates the solenoid to power the motor.

### Lubrication System

The lubrication system makes sure that every moving part in the engine gets oil so that it can move easily. The two main parts needing oil are the pistons (so they can slide easily in their cylinders) and any bearings that allow things like the crankshaft and camshafts to rotate freely. In most cars, oil is sucked out of the oil pan by the oil pump, run through the oil filter to remove any grit, and then squirted under high pressure onto bearings and the cylinder walls. The oil then trickles down into the sump, where it is collected again and the cycle repeats.

### Fuel System

The fuel system pumps gas from the gas tank and mixes it with air so that the proper air/fuel mixture can flow into the cylinders. Fuel is delivered in three common ways: carburetion, port fuel injection and direct fuel injection.

- In carburetion, a device called a carburetor mixes gas into air as the air flows into the engine.
- In a fuel-injected engine, the right amount of fuel is injected individually into each cylinder either right above the intake valve (port fuel injection) or directly into the cylinder (direct fuel injection).

### Exhaust System

The exhaust system includes the exhaust pipe and the muffler. Without a muffler, what you would hear is the sound of thousands of small explosions coming out your tailpipe. A muffler dampens the sound. The exhaust system also includes a catalytic converter.

### Emission Control

The emission control system in modern cars consists of a catalytic converter, a collection of sensors and actuators, and a computer to monitor and adjust everything. For example, the catalytic converter uses a catalyst and oxygen to burn off any unused fuel and certain other chemicals in the exhaust. An oxygen sensor in the exhaust stream makes sure there is enough oxygen available for the catalyst to work and adjusts things if necessary.

### Electrical System

The electrical system consists of a battery and an alternator. The alternator is connected to the engine by a belt and generates electricity to recharge the battery. The battery makes 12-volt power available to everything in the car needing electricity (the ignition system, radio, headlights, windshield wipers, power windows and seats, computers, etc.) through the vehicle's wiring.

## **Упр. 14. Выполните письменный перевод следующего текста.**

The compression-ignition engine, designed by the German Rudolf Diesel in 1896, was equipped with the carburetor and sparking plugs of the petrol engine. The gas inside the cylinder on the compression stroke is pure air, which is compressed to 1:14 to 1:20 of its initial volume - a much higher compression ratio than is used in petrol engines. At the top of the compression stroke a fine spray of oil fuel is injected into the cylinder. As gas compressed its temperature increases, so that the oil spray meets the air charge at a temperature sufficiently high to ignite it spontaneously. Because of its high compression ratio the compression-ignition or diesel engine is more efficient than a petrol engine. But for the same reason it must be more heavily built, thus offsetting the advantage somewhat. Diesel engines offer economies in fuel consumption at the expense of a loss in performance, they are particularly suited to frequent stop and start duties, and as a result are widely used in taxis, busses and lorries.



**Упр. 15. Составьте письменный реферат об основных системах автомобиля и их функциях, используя следующие выражения:**

The text is concerned with ... . ... are considered. It should be noted that ... . The fact that ... is stressed. It should be remembered that ... .

Unit 4

Producing More Power

**Упр. 1. Запомните новые слова и выражения их значения.**

1. displacement - рабочий объем
2. compression ratio – коэффициент сжатия
3. cram (v) - втолкнуть
4. expand (v) - расширять(ся)
5. lessen (v) - уменьшать
6. intake valve - впускной клапан
7. back pressure - обратное давление
8. lightweight - легковесный
9. inject (v) - впрыскивать
10. mileage - пробег
11. density - плотность
12. intercooler - промежуточный охладитель
13. intake manifold - впускной коллектор
14. muffler - глушитель
15. high-performance - с высокими эксплуатационными характеристиками
16. header - головная часть; сборник коллектора
17. two-stroke - двухтактный
18. rotation - вращение
19. eliminate (v) - устранить, исключить

**Упр. 2. Прочтите и переведите интернациональные слова.**

Information, efficient, cylinder, limit, compression, octane, sort, inter-cooler, radiator, filter, effect, start, energy, meter, diesel, motor, cycle, turbine, qualification, special, distance, center.

**Упр. 3. Переведите предложения на русский язык обращая, внимание на новые слова.**

1. More displacement means more power because you can burn more gas during each revolution of the engine. 2. An intercooler is a special radiator through which the compressed air passes to cool it off before it enters the cylinder. 3. If the exhaust pipe is too small or the muffler has a lot of air resistance, this can cause back-pressure. 4. High-performance exhaust system use headers, big tail pipes and free-flowing mufflers to eliminate back pressure in the exhaust system. 5. High-performance cars are generally using higher compression ratios to get more power. 6. A two-stroke engine produces a lot of power for its size because there are twice as many combustion cycles occurring per rotation. 7. As piston moves down in the intake stroke, air resistance can take power from the engine.

**Упр. 4. Переведите выделенные слова на английский язык, используя активный словарь урока.**

1. Higher (**коэффициенты сжатия**) produce more power, up to a point. 2. Higher-octane gasoline (**предотвращает**) this sort of early combustion. 3. If you can (**втолкнуть**) more air into a cylinder of a given size, you can get more power from the cylinder. 4. The hotter air is, the less it will (**расширяться**) when combustion takes place. 5. (**Легковесные**) parts help the engine perform better. 6. (**Дизельное топливо**) has a higher energy (**плотность**) than gasoline, so a diesel engine gets better (**пробег**). 7. (**Дизельное топливо**) (**впрыскивается**) into the cylinder and the heat and pressure of the compression stroke (**заставляют**) the fuel to (**воспламеняться**).

**Упр. 5. Выберите правильное определение для каждого данного слова и переведите их на русский язык.**

intercooler, cylinder, fuel injection, ratio, manifold.

1. the tube within which a piston moves towards and backwards in an engine.
2. relation between two amounts determined by the number of times one contains the other.
3. special radiator through which the compressed air passes to cool it off before it enters the cylinder.

4. pipe or chamber with several openings, for connections, e. g. for leading gases into or out of cylinders.
5. method by which liquid is converted to vapour and sprayed into the cylinders of an internal combustion engine.

**Упр. 6. Переведите предложения на русский язык, обращая внимание на употребление многофункционального слова “that”.**

1. In 1890s, Rudolf Diesel, a German, invented the engine that bears his name. 2. Their vehicles are equipped with special devices that give them independent mobility without any assistance. 3. Since the density of titanium is about half that of steel, titanium can perform the same task as steel springs. 4. Today that price has dropped to around \$500 per kW - but that means that a fuel-cell engine still costs about \$25,000. 5. The fatigue of welded joints puts a limit on the strength of the steel that can be used in forming parts. 6. The center of the axle is bent down, so that it is the lowest point of the car. 7. Besides the compressed mixture produced more power than that uncompressed.

**Упр. 7. Переведите предложения на русский язык, обращая внимание на перевод модальных глаголов.**

1. Albion Automotive is to supply rear axles for Renault Trucks' commercial vans. 2. A brand new electric power-steering system should improve controllability. 3. The car can be equipped with one of four turbo engines, the gasoline engines, and a 1.9-litre diesel engine. 4. Like it or not, the automobile world had to get used to the car's new appearance. 5. Mass production of the model was to begin in a year. 6. It should be remembered that although Distronic system can reduce stress it cannot replace the human driver. 7. You might be disappointed that New Beetle is indistinguishable from standard Beetle. 8. Each diesel engine can be fitted with a manual or an automatic gearbox. 9. Daimler-Chrysler is to use special lightweight doors made by Wagon for its cars. 10. Modern roads should be designed according to the anticipated volume and speed of the traffic. 11. Keeping the distance may save your life.

**Упр. 8. Переведите предложения на русский язык, обращая внимание на перевод герундия.**

1. Each component is designed to reduce weight without compromising safety strength, stiffness and durability. 2. Black and white arrow-

indicator navigation systems are popular because they have the advantage of being much simpler. 3. The engine is capable of being developed to provide required levels of performance vehicle meeting or exceeding **the world's strictest emission standards**. 4. **Dips, sprays and different coatings** are among the methods for preventing contact between hostile environmental elements and metals. 5. Being unfamiliar or inexperienced with the motorcycle increases the risk of being involved in an accident. 6. The first engines appeared in the 17<sup>th</sup> century and people began using them to operate factories, irrigate lands, supply water to town.

**Упр. 9. Переведите предложения на русский язык, обращая внимание на перевод причастие I и причастие II.**

a) 1. Turbochargers and supercharges pressurize the incoming air to cram more air into a cylinder. 2. Many turbocharged and supercharged cars have an intercooler, through which the compressed air passes. 3. Some newer cars are using polished intake manifolds to eliminate air resistance. 4. A blocked filter decreases the air flow to the carburetor, thus increasing the amount of fuel in the mixture. 5. A gas burnt during each revolution of the engine gives more power. 6. The compressed air passes through the intercooler. 7. Kerosene is the fuel used in jet engines. 8. You can cram more air and fuel into a cylinder of a given size. 9. A two-stroke engine has no moving valves.

b) 1. Compressing air raises its temperature. 2. Using the mechanism called gearbox different speeds can be obtained. 3. Making the cylinder bigger or adding more cylinders you can increase displacement. 4. Air resistance can be lessened by putting two intake valves in each cylinder. 5. Burning in the engine the fuel-air mixture produces energy. 6. Starting a V-8 engine, you are only driving two cylinders through their strokes. 7. Increasing the size of the cylinder, you can get more power from it. 8. Using more gasoline and burning lots of oil, the two-stroke engine is far more polluting.

**Упр. 10. Переведите цепочки однокоренных слов.**

1. purpose – purposeful – purposeless – purposed
2. radiate – radiation – radiator
3. distribute – distributor – distributing – distribution
4. reduce – reduction – reducing – reduced
5. require – required – requirement – requiring

6. adjust – adjustable – adjuster – adjustment – adjusted  
 7. essence – essential – essentially – essentiality

**Упр. 11. Образуйте от данных прилагательных существительные и переведите.**

Smooth - ... . Powerful - ... . Different - ... . Hard - ... . Available - ... .  
 Reliable - ... . Useless - ... . Active - ... .

**Упр. 12. Назовите новые слова с окончанием –able/-ible и переведите их на русский язык.**

1. that can be moved	5. that can be solved
2. that can be reached	6. that can be used or obtained
3. that can be managed	7. that can be permitted
4. that can be changed for new needs	8. that can provide comfort

**Упр. 13. Прочитайте и переведите текст, обращая внимание на степени сравнения прилагательных и конструкции типа the ..., the... .**

Using all of this information, you can begin to see that there are lots of different ways to make an engine perform better. Car manufacturers are constantly playing with all of the following variables to make an engine more powerful and/or more fuel efficient.

Increase displacement. More displacement means more power because you can burn more gas during each revolution of the engine. You can increase displacement by making the cylinders bigger or by adding more cylinders. Twelve cylinders seem to be the practical limit.

Increase the compression ratio. Higher compression ratios produce more power, up to a point. The more you compress the air/fuel mixture, however, the more likely it is to spontaneously burst into flame (before the spark plug ignites it). Higher-octane gasoline prevents this sort of early combustion. That is why high-performance cars generally need high-octane gasoline - their engines are using higher compression ratios to get more power.

Stuff more into each cylinder. If you can cram more air (and therefore fuel) into a cylinder of a given size, you can get more power from the cylinder (in the same way that you would by increasing the size of

the cylinder). Turbochargers and superchargers pressurize the incoming air to effectively cram more air into a cylinder.

Cool the incoming air. Compressing air raises its temperature. However, you would like to have the coolest air possible in the cylinder because the hotter the air is, the less it will expand when combustion takes place. Therefore, many turbocharged and supercharged cars have an intercooler. An intercooler is a special radiator through which the compressed air passes to cool it off before it enters the cylinder.

Let air come in more easily. As a piston moves down in the intake stroke, air resistance can rob power from the engine. Air resistance can be lessened dramatically by putting two intake valves in each cylinder. Some newer cars are also using polished intake manifolds to eliminate air resistance there. Bigger air filters can also improve air flow.

Let exhaust exit more easily. If air resistance makes it hard for exhaust to exit a cylinder, it robs the engine of power. Air resistance can be lessened by adding a second exhaust valve to each cylinder (a car with two intake and two exhaust valves has four valves per cylinder, which improves performance - when you hear a car ad tell you the car has four cylinders and 16 valves, what the ad is saying is that the engine has four valves per cylinder). If the exhaust pipe is too small or the muffler has a lot of air resistance, this can cause back-pressure, which has the same effect. High-performance exhaust systems use headers, big tail pipes and free-flowing mufflers to eliminate back-pressure in the exhaust system. When you hear that a car has "dual exhaust," the goal is to improve the flow of exhaust by having two exhaust pipes instead of one.

Make everything lighter. Lightweight parts help the engine perform better. Each time a piston changes direction, it uses up energy to stop the travel in one direction and start it in another. The lighter the piston, the less energy it takes.

Inject the fuel. Fuel injection allows very precise metering of fuel to each cylinder. This improves performance and fuel economy.

Difference between a gasoline engine and a diesel engine. In a diesel engine, there is no spark plug. Instead, diesel fuel is injected into the cylinder, and the heat and pressure of the compression stroke cause the fuel to ignite. Diesel fuel has a higher energy density than gasoline, so a diesel engine gets better mileage.

Difference between a two-stroke and a four-stroke engine. Most car and boat motors use two-stroke engines. A two-stroke engine has no

moving valves, and the spark plug fires each time the piston hits the top of its cycle. A hole in the lower part of the cylinder wall lets in gas and air. As the piston moves up it is compressed, the spark plug ignites combustion, and exhaust exits through another hole in the cylinder. You have to mix oil into the gas in a two-stroke engine because the holes in the cylinder wall prevent the use of rings to seal the combustion chamber. Generally, a two-stroke engine produces a lot of power for its size because there are twice as many combustion cycles occurring per rotation. However, a two-stroke engine uses more gasoline and burns lots of oil, so it is far more polluting.

Advantages of steam engines and other external combustion engines. The main advantage of a steam engine is that you can use anything that burns as the fuel. For example, a steam engine can use coal, newspaper or wood for the fuel, while an internal combustion engine needs pure, high-quality liquid or gaseous fuel.

Types of cycles used in car engines. The two-stroke engine cycle is different, as is the diesel cycle described above. The engine in the Mazda Millennia uses a modification of the Otto cycle called the Miller cycle. Gas turbine engines use the Brayton cycle. Wankle rotary engines use the Otto cycle, but they do it in a very different way than four-stroke piston engines.

Eight cylinders in an engine are better than one big cylinder of the same displacement. There are a couple of reasons why a big 4.0-liter engine has eight half-liter cylinders rather than one big 4-liter cylinder. The main reason is smoothness. A V-8 engine is much smoother because it has eight evenly spaced explosions instead of one big explosion. Another reason is starting torque. When you start a V-8 engine, you are only driving two cylinders (1 liter) through their compression strokes, but with one big cylinder you would have to compress 4 liters instead.

#### **Упр. 14. Выполните письменный перевод следующего текста.**

The power gas engine

The gas turbine, a completely different kind of engine, was first designed at the beginning of the twentieth century and perfected in the 1930s. It usually has a single shaft carrying a series of propeller-like fans divided into two groups, the compressor and the turbine. In

an operating gas turbine air is drawn in the compressor fans and its pressure increased. The compressed air is mixed with fuel and ignition takes place, further increasing temperatures and pressures. The burned mixture leaves the engine through the turbine, driving the blades round. The compressor, which is often driven directly by the turbine, takes up much of the power produced, but enough is left to make the gas turbine exceedingly powerful form of engine. Efficiencies are not high, but the good power-to-weight ratio of a gas turbine makes it suitable for aircraft propulsion. A gas turbine is about three times as powerful as a piston engine of the same weight.

**Упр. 15. Составьте письменный реферат, рассказывающий об основных способах увеличения мощности двигателя, используя следующие выражения:**

The text is devoted to ... . ... are given. The importance of ... is stressed. There is no doubt that ... . It is pointed out that ... .

## Unit 5

### The New Golf R32

**Упр. 1. Запомните новые слова и выражения и их значения.**

1. accelerate (v) – разгоняться, ускоряться
2. adjustable - регулируемый
3. alloy wheels – литые диски
4. anti-dazzle - противоослепляющий
5. built-in head restraints – встроенные подголовники
6. camshaft - распредвал
7. cylinder knock – детонация в цилиндре
8. exhaust system – выхлопная система
9. four-wheel drive – привод на 4 колеса (полноприводный)
10. gearbox – коробка передач
11. gear gate (reduced) – кулиса коробки передач (укороченная); уменьшенные промежутки между передачами
12. gear lever – рычаг переключения передач
13. headlights - фары
14. heated seats – сиденья с подогревом
15. intake manifold – впускной коллектор



16. naturally aspirated engine – атмосферный двигатель
17. performance – эксплуатационные качества
18. rear (adj) – задний
19. running gear - шасси
20. steering wheel – рулевое колесо
21. top-of-the-range - высококлассный
22. top speed – предельная скорость
23. torque – крутящий момент

**Упр. 2. Прочтите и переведите интернациональные слова.**

Sport car, luxury-class technology, market segment, cylinder, technical, geometry, standard, model, design modifications, aluminium components, pedal, centre console, dynamic design, electronically controlled air conditioning, radio system, multi-function display, dynamic potential, compact class, unique, class, sensor.

**Упр. 3. Переведите предложения на русский язык обращая, внимание на новые слова.**

1. The technical features include an adjustable intake and exhaust camshaft, cylinder-selective knock control and variable intake manifold geometry. 2. The new R 32 is a top-of-the-range car with a manual six-speed gearbox. 3. The new front sport seats with built-in head restraints and special leather steering wheel were designed for more sporty drivers. 4. The R32 is the combination of naturally aspirated six-cylinder engine and a four-wheel drive. 5. The new model of the car has automatic air-conditioning, alloy wheels, multi-function computer and some other elements. 6. It also possesses a gearbox with interior reduced gear gate.

**Упр. 4. Переведите выделенные слова на английский язык, используя активный словарь урока.**

1. The new Golf R32 has (предельную скорость) of 247 kmh with 320Nm (крутящий момент). 2. Golf is characterized by significant design modifications to the (передний и задний) section. 3. Golf R32 can (разогнаться) to 100 kmh in just 6.6 seconds. 4. The power of the engine is transmitted via a six-speed (коробка передач). 5. The R32 has double (выхлопную систему) with twin chrome-plated (выхлопные трубы). 6. Golf has a range of standard equipment including (противо-

ослепляющее) interior mirror, (сидения с подогревом), and (фары) with washer system. 7. Brushed aluminum components include the pedals, centre console and (рычаг переключения передач).

**Упр. 5. Выберите правильный перевод словосочетаний, где слово "DRIVE" является определяющим.**

- |                              |   |
|------------------------------|---|
| 1) twin-camshaft chain drive | a) шестеренный привод клапанного механизма  |
| 2) camshaft drive            | b) привод счетчика пробега                  |
| 3) camshaft gear drive       | c) привод от двигателя                      |
| 4) rear-axle gear drive      | d) цепной привод с двумя распределителями   |
| 5) pneumatic drive           | e) поршневой привод                         |
| 6) engine drive              | f) привод с тремя ведущими мостами          |
| 7) valve-gear drive          | g) шестеренный привод распределителя        |
| 8) odometer drive            | h) привод распределителя                    |
| 9) multiple strand drive     | i) пневматический привод                    |
| 10) piston drive             | j) шестеренная передача                     |
| 11) tri-axle drive           | k) передача с несколькими клиновыми ремнями |

**Упр. 6. Выберите правильное определение для каждого данного слова и переведите их на русский язык.**

piston rings, gear, torque, accelerate, console.

1. the force of power that makes something turn around a central point, especially in an engine.
2. increase the speed, cause to move faster.
3. a set of toothed wheels working together in a machine, to connect a motor car engine with the road wheels.
4. a flat board that contains the controls for a machine, piece of electrical equipment.
5. a circular metal spring used to stop gas or liquid escaping from between piston and the tube that moves in.

**Упр. 7. Переведите предложения на русский язык, обращая внимание на перевод глаголов в пассивном залоге.**

1. A Ford Fiesta is being equipped with VTES (Visteon's torque enhancement system). 2. Much effort has been applied to the interior: new decorating materials have been used and the colour palette revised. 3. The company was founded in 1889 and since then it has been engaged in the construction of coach work for passenger transport. 4. Technology developed for the aeronautical industry has been used, giving an aerodynamic design full of elegance and clarity of line. 5. Research is being conducted to develop well-designed in-vehicle human/machine interfaces for safe driving. 6. The instrument panel has also been newly designed.

**Упр. 8. Переведите предложения на русский язык, обращая внимание на перевод Perfect Participle и Passive Participle.**

a) 1. Having noticed a fuel warning light on the instrument panel of your car you should fill up the tank with more petrol. 2. Having entered the engine, impurities damaged the cylinders, piston and piston rings. 3. Having pressed the brake pedal, you can stop the car immediately. 4. Having been cleaned the air filter increases the airflow. 5. Having discovered a broken pump, it's a good idea to repair it. 6. Having been pushed forwards and backwards, the car couldn't be released. 7. Having been carefully tested, the new braking system was approved.

b) 1. Being designed by Volkswagen, R32 can accelerate to 100 kmh in just 6.6 seconds. 2. Being equipped with the adjustable intake and exhaust camshaft, the new R32 has an advantage. 3. Being oiled, the moving parts work almost without any friction. 4. Being redesigned completely, the new R32 became more efficient. 5. Being repaired by a skillful mechanic, the exhaust system is now in order. 6. Being covered with oil the spark plugs didn't give any spark. 7. Being provided with batteries, an electric car can develop a speed of 50 miles an hour.

**Упр. 9. Образуйте существительные, используя различные суффиксы и переведите их.**

-ment:	to arrange, to improve, to move, to achieve, to measure, to require, to develop, to adjust, to manage
--------	---

-ness:	tough, bright, thick, effective, tight, smooth, affective, sharp
-age:	to break, to pass, to use, volt, leak, link, mile, store
-ion:	to attract, to reflect, to discuss, to indicate, to insulate, to ignite, to actuate, to reduce
-ation:	to combine, to examine, to inform ,to install, to implement
-or:	to resist, to conduct, to compress, to accelerate, to ventilate, to create, to generate,

**Упр. 10. Образуйте прилагательные, используя различные суффиксы и переведите их на русский язык.**

-ic:	atmosphere(e), period, metal, electron
-al:	experiment, natur(e),physic(s), mechanic, environment convention, practice
-able:	value(e), change, measure(e),compare(e), rely, suit, reason, comfort, adjust, vary
-ant:	import, resist, pollute

**Упр. 11. Переведите цепочки однокоренных слов.**

1. rear – rearward – rewards – rear view – rear view mirror
2. improve – improvement – improved – improving
3. replace – replacement – replaced – replacing
4. power – powerful – powerless
5. imitate – imitation – imitative – imitator
6. consider – considered – considerable – considering
7. ignite – igniter – ignition

**Упр.12. Прочитайте и переведите текст. Найдите 5 предложений в пассивном залоге. Найдите ключевые слова и выражения для составления аннотационного перевода.**

The new Golf R32 has a top speed of 247 kmh, having the same 3.2-litre V6 engine, with 320 Nm torque, as the VW Phaeton.

Never before has there been a standard Golf with such a powerful engine as the new R32. Its 177 kW, 3.2-litre V6 engine - which is also used in the new Phaeton - gives it a performance comparable to that of a sports car. This means that the R32 designed by Volkswagen can accelerate to 100 kph in just 6.6 seconds, and has a top speed of 247 kph. With this sporty top-of-the-range Golf, Volkswagen is introducing luxury-class technology into other market segments.

The technical features of this compact six-cylinder model include a continuously adjustable intake and exhaust camshaft, cylinder knock control and variable intake manifold geometry. The torque of the engine (up to 320 Nm) is transmitted to the standard 4motion four wheel drive via a six-speed gearbox with reduced gear gates. The R32's double exhaust system with twin chrome-plated tailpipes gives it a suitably distinctive sound.

Visually, the new Golf is characterized by a sports running gear 20 mm lower than that of the standard model, 18-inch alloy wheels with 225/40 ZR 18 tyres, and significant design modifications to the front and rear sections.

Inside, brushed aluminium components including the pedals, centre console and gear lever, emphasized the dynamic design of the R32. The new front sport seats with built-in head restraints and the special R32 leather steering wheel were designed for more sporty driver.

The R32, which is initially only available as a two-door model, has a comprehensive range of standard equipment, including electronically controlled air conditioning, a radio system with eight speakers, a multi-function display, a rain sensor, an automatic anti-dazzle interior mirror, heated seats and Xenon headlights with a headlight washer system.

The R32 is the top-of-the-range model in the Golf series, and its overall drive characteristics provide an impressive demonstration of the dynamic potential of the best selling car in the compact class. Not only that, but the R32 also shows what is possible when luxury class technology is transferred to smaller classes of vehicle. This is because the R32's combination of such a powerful, naturally aspirated six-cylinder engine and four-wheel drive as standard is still unique in this sector.

### **Упр.13. Выполните письменный перевод следующего текста.**

Fuel and exhaust pass in and out of a four-stroke engine using a more sophisticated system of valves, controlled automatically by camshaft dri-

ven direct from the engine's crankshaft. As the engine operates, the valves are successively opened and closed, the moment of ignition of the fuel must also be accurately controlled. This is done by a distributor, again mechanically connected to the crankshaft which directs a current of electricity successively to each of the cylinders. This current "fires" a spark in the spark plugs and the fuel is ignited. Otto's engines ran on coal gas, a perfectly satisfactory fuel but one that is difficult to store. The gas engine was greatly improved by the use of liquid fuels such as petrol (gasoline) made by refining crude oil. To turn petrol into a combustible vapor it is mixed with air to form a fine mixture of droplets that can be drawn into the cylinders. The mixing is carried out in a carburetor.

**Упр.14. Составьте аннотацию текста "The new Golf R32", используя следующие выражения:**

It is reported ... . are noted. It should be stressed that ... . The basic approach of the author is that ... .

## Unit 6

### Vectra Aims For New Image

**Упр. 1. Запомните новые слова выражения и их значения.**

1. available – доступный, имеющийся в наличии
2. clutch - сцепление
3. enhance(v) – повышать, увеличивать, улучшать
4. ensure (v)- обеспечивать, гарантировать
5. exterior – внешний вид
6. feedback – обратная связь
7. gearbox – коробка передач
8. head restraints- подголовники
9. injury - повреждение
10. impact - столкновение
11. launch (v) – запускать, выпускать
12. manual shift – ручное переключение
13. occupancy detector – датчик присутствия
14. power output – выходная мощность
15. predecessor – предшественник
16. provide (v) -обеспечивать

17. safety - безопасность
18. spacious – обширный
19. steering – управление, рулевое управление, рулевой механизм
20. throttle – дроссельная заслонка
21. torsional stiffness – торсионная жесткость, (жесткость на кручение)
22. tyre pressure monitoring system – система контроля давления в шинах

**Упр. 2. Запомните перевод и объяснение следующих сокращений.**

1. GM (General Motors) – автомобильная компания “Дженерал Моторс”
2. IDS (Interactive Driving System) - интерактивная система управления
3. CBC (Cornering Brake Control) – контроль тормозов при повороте
4. ESP (Electronic Stability Programme) - программа электронной стабильности
5. EBD (Electronic Brake Force Distribution) – электронное распределение тормозной силы
6. ps (pherdestaerken (German) – horse power – лошадиная сила
7. ABS (Anti-lock Braking System) – анти-блокировочная тормозная система.
8. VVT (Variable Valve Timing) – регулирование времени открытия/закрытия клапана
9. CVT (Continuously Variable Transmission) – бесступенчатая коробка передач, вариатор

**Упр. 3. Прочтите и переведите интернациональные слова.**

Chassis, electronic stability programme, pedal, monitoring system, aerodynamics, computer, simulation, charisma, interactive, comfort, positive, detector, type, typical, model, tunnel, automatic, function.

**Упр. 4. Переведите предложения на русский язык обращая, внимание на новые слова.**

1. The Mitsubishi Eclipse 2006 includes such notable features as four-wheel disc brakes with ABS and side-impact airbags.
2. The Jaguar X-type Estate will have a sedan engine (2-litre diesel or 3-litre V6) and a choice between front-wheel drive and four-wheel drive.
3. The base model of BMW X5 comes with a six-speed trans-

mission and a new 218hp/500Nm, 3-litre turbo diesel engine. 4. The basic specification level in the Opel Corsa includes ABS braking and an emergency braking system. 5. A new electric power-steering system should improve controllability. 6. IDS is an electronic management system that interacts with the chassis, steering and braking for increasing driver feedback, comfort and safety. 7. There is also a seat occupancy detector and a tyre pressure monitoring system. 8. GM Europe is particularly pleased with the electro-hydraulic power steering.

**Упр. 5. Переведите выделенные слова на английский язык, используя активный словарь урока.**

1. The car is equipped with (безопасность) features, including (воздушную подушку) and (подголовники-ограничители). 2. In the event of (столкновения) the (педали тормоза и сцепления) are disengaged to protect the driver from injuring. 3. Electro-hydraulic power steering (обеспечивает) a positive response to the driver. 4. Electronic (контроль дроссельной заслонкой) has improved (управляемость) and a lighter pedal action. 5. The five-speed automatic active select (коробка передач) with (функция ручного управления) first appeared on the Vectra. 6. Opel Vectra proved for its drivers (интерактивную систему управления) for safety and comfort. 7. There are three petrol and diesel engines with (выходная мощность) from 122ps to 211ps. 8. The body has (торсионную жесткость) greater than its previous model. 9. Two (коробки передач) first appeared on the Vectra: the five-speed automatic and CVTronic.

**Упр. 6. Выберите правильное определение для каждого данного слова и переведите их на русский язык.**

mirror, spark plug, chassis, brake, throttle(v), mode.

1. device for reducing speed or stopping motion, e.g. of a bicycle, motor-car, train.
2. to control the flow of steam, petrol, vapour, etc. in an engine; lessen the speed of an engine by doing this.
3. polished surface reflecting images: in a car to enable the driver to see what is behind him.



4. framework of a motor-car or aircraft on which the body is fastened or built.
5. a part in a car engine that produces an electric spark to make the petrol mixture start burning
6. a manner in which a process is carried out.

**Упр. 7. Переведите предложения, обращая внимания на выделенные слова.**

1. In case of an impact both the brake and clutch pedals are disengaged.
2. Two gearboxes are used on the Vectra: the five-speed automatic with manual shift function and the CVTronic. The former which is adaptive is available on both the petrol and diesel engine while the latter is available with petrol engine.
3. The bending stiffness of the body has increased due to the greater use of high-strength steels. In total 15 different types of steel are used.
4. Initially there are three petrol and two diesel engines, with power output ranging from 122 hp to 211 hp, available, but these will be topped by some performance versions in the range powered by a petrol and diesel engine.

**Упр. 8. Переведите предложения на русский язык, обращая внимание на перевод эмфатических конструкций.**

1. It is in this regime that there is now the greatest call from customers for engines that can pull away at 100 rpm with a rising torque level.
2. Never before has there been a standard Golf with such a powerful engine as the new R32.
3. It was not until 1886 that two scientists separately but simultaneously invented the electrolytic process that is the basis of all aluminium production today, the Hall-Heroult process.
4. It was not until 1808 that Sir Humphrey Davy established the existence of aluminium and named it.
5. Never before has a new class of vehicles been attended so much publicity as Land Rover.
6. Nowhere can we see such a rapid development as in automobile designing.

**Упр. 9. Переведите предложения на русский язык, обращая внимание на перевод герундия.**

1. On examining the car before starting on a long journey a driver can be sure that he will get to his destination without accidents.
2. By summing up the information about the speed and distance of various objects on the

road, the computer detects all possible dangers. 3. In future in switching over to the new Earth satellite a driver can be sure of coming safely to his destination. 4. At low speeds the engine can use turbines for compressing the air before mixing it with the fuel in the combustion chamber. 5. Cryogenic fuels will vaporize before being injected into combustion chamber. 6. A new carburetor offers easier starting in cold weather. 7. By using the automatic guidance system a driver will be able to make long journeys without concentrating on the road conditions. 8. It is impossible to solve economic problems without using the achievements of the scientific and technological revolution.

**Упр. 10. Переведите предложения на русский язык, обращая внимание на перевод условных предложений.**

1. The experiment would have been carried out a week ago, if the device hadn't been broken. 2. It would take too much time to carry heavy loads unless the cars were constructed. 3. If the charge of air and fuel cannot be compressed properly, the combustion process will not work like it should. 4. If your spark plug or the wire is leading to it is worn out, the spark will be weak. 5. If someone sticks a potato up your tailpipe, exhaust cannot exit the cylinder soothe engine will not run. 6. If gears are in a neutral position, the power of the engine will end at the end of the secondary shaft of transmission. 7. If the base structure of a vehicle is designed to accommodate loads, then it will be overdesigned when running unloaded.

**Упр. 11. Переведите следующие слова с префиксами dis-, in-, im-, il-, un-.**

charge – discharge  
continuous – discontinuous  
close – disclose  
connect – disconnect  
advantage – disadvantage  
regular – irregular  
complete – incomplete  
appear – disappear  
correct – incorrect  
placement – displacement

accurate – inaccurate  
movable – immovable  
logical – illogical  
important – unimportant  
credible – incredible  
like – unlike  
notice – unnoticed  
possible – impossible  
familiar – unfamiliar  
expensive – inexpensive

**Упр. 12. Прочитайте и переведите текст. Найдите и переведите предложения, характеризующие технологические особенности автомобиля.**

The Vectra is a familiar sight on European roads. So what does Opel/Vauxhall provide for its drivers? One feature is its interactive driving system (IDS). This is an electronic management system that interacts with the chassis, steering and braking for increasing driver feedback, comfort and safety. GM Europe is particularly pleased with the electro-hydraulic power steering. Its main aim is providing a positive and class-leading response to the driver.

The brake systems comprise Anti-lock brakes (ABS), cornering brake control (CBC), electronic brake force distribution (EBD) and an enhanced electronic stability programme (ESP). This is the most important way of ensuring that the new Vectra has a dynamic and yet safe feel to it, especially when being driven at speed.

Another driving feature is the drive-by-wire electronic throttle control for all petrol engines, for improved driveability and a lighter pedal action.

The car is equipped with safety features, including front, side and curtain airbags and active head restraints. There is also a seat occupancy detector and a tyre pressure monitoring system. In the event of an impact, both the brake and clutch pedals are disengaged to protect the driver from injuring to the feet and lower legs.

A great attention has been given to the exterior. The second-generation Vectra is the first model in Opel/Vauxhall's new design line. It is famous for having good aerodynamics, the result of hard work in the wind tunnel and in computer-aided simulation.

The body has a torsional stiffness 74 per cent greater than previous model and the bending stiffness has increased by 62 per cent due to the greater use of high-strength steels. In total 15 different types of steel are used.

Initially there are three petrol and two diesel engines, with power output ranging from 122 ps to 211 ps (90-163 kW) available, but these will be topped by some performance versions in the range powered by a petrol 3.2 litre V6 and diesel 3.0 litre V6.

Two gearboxes first appear on the Vectra: the five-speed automatic Active Select with manual shift function, and the CVTronic. The

former, which is adaptive, is available on both the petrol and diesel-engined 2.2 16-valve and the new 3.2 litre V6, while the latter is available with the 1.8 16-valve petrol engine. Described as a six-speed, there are three gearshift modes: fully stepless automatic; manual, using the six predefined gears; and full automatic transmission mode, in which the six gear steps can be activated so the CVTronic acts like a conventional six-speed box.

In fact, the new model that has recently been launched is an example of what can be achieved with cars the main purpose of which is having been designed with mass sales in mind. It is efficient, spacious, pleasant to drive, well built and has reasonable running costs. It is far superior to the predecessor model. It is just lack of the quality called charisma.

### **Упр. 13. Выполните письменный перевод следующего текста.**

Keeping your distance may save your life – this is a road safety truth. By ensuring that you have a sufficient stopping distance at all times, even should the driver ahead suddenly slam on the brakes for no apparent reason, you can eliminate a major cause of accidents. Out on the road, however, people often fail to maintain the necessary minimum gap; after all, it costs a great deal of concentration to observe this rule at all times. With the DISRTONIC distance monitoring system, proximity to the vehicle in front can be kept to the limit without the driver right to decide. This new system is based on **radar technology**. **DISTRONIC's invisible radar signals constantly** measure the distance to the vehicle in front. A computer processes the data and prompts the reaction if necessary. **If the driver's car is** too close, it will be gently braked, automatically, until sufficient distance is restored. In this process, deceleration is limited to one-fifth of the maximum available braking power, so sudden sharp braking by the system is not be feared. Heavy braking is not used even if the driver in front panic-brakes: In that case, DISTRONIC is automatically deactivated, a warning light shows up on the speedometer, and an acoustic signal urges the driver to promptly assume command over the brakes.

**Упр.14. Составьте аннотацию к тексту. Расскажите об основных составляющих “Vectra aims for new image”, используя следующие выражения:**

The text deals with ... . The text gives a valuable information on ... . Attention is drawn to the fact that ... .are discussed. Underlined is the conclusion that ... .

## Unit 7

### Hybrid Cars

**Упр. 1. Запомните новые слова и выражения и их значения.**

1. emissions - выбросы
2. fuel consumption – потребление топлива
3. green house effect – парниковый эффект
4. mileage – пробег
5. parallel hybrid – гибрид с параллельным приводом
6. pollution - загрязнение
7. propulsion – движущая сила; силовая установка
8. provide(v) – обеспечивать, снабжать
9. reduce(v) – снижать
10. regenerative braking – рекуперативное торможение
11. series hybrid – гибридный автомобиль с последовательным приводом
12. set of batteries – блок батарей
13. sophisticated - сложный
14. supply(v) - поставлять
15. turn(v) – приводить в движение, вращать
16. twofold – двоякий , двусторонний
17. tyre(tire) - шина
18. vehicle – транспортное средство
19. efficiency – производительность, продуктивность
20. storage – накопление, хранение, хранилище

**Упр. 2. Прочтите и переведите интернациональные слова.**

Hybrid, technology, version, effect, automobile, plan, to combine, moped, type, locomotive, diesel-electric, transmission, electricity, electric motor, structure, parallel, generator, energy, machine, generate, percent.

**Упр. 3. Переведите предложения на русский язык обращая, внимание на новые слова.**

1. Any vehicle that combines two or more sources of power that can directly or indirectly provide propulsion power is a hybrid. 2. Both the engine and the electric motor can turn the transmission at the same time, and the transmission then turns the wheels. 3. The fuel tank in a hybrid is the energy storage device for the gasoline engine. 4. The amount of pollution allowed does not depend on the mileage your car gets. 5. That pollution will have to be removed by the emissions control equipment on the car. 6. The engine on a hybrid is smaller and uses advanced technologies to reduce emissions and increase efficiency. 7. The generator is similar to an electric motor, but it acts only to produce electrical power. 8. Instead of just using brakes to stop the car the electric motor can also slow down the car.

**Упр. 4. Переведите выделенные слова на английский язык, используя активный словарь урока.**

1. A gas-powered car has a fuel tank which (снабжает) gasoline to the engine. 2. The reason is (двоякий): (сократить) tailpipe (выбросы) and to improve mileage. 3. Any (транспортное средство) is a hybrid when it combines two or more sources of power. 4. But a car that burns twice as much gas to go a mile will generate approximately twice as much (загрязнение). 5. The motor (приводит в движение) a transmission and the transmission (приводит в движение) wheels. 6. So decreasing (потребления топлива) of the car is one of the surest ways of decreasing (выбросы). 7. As a result in a parallel hybrid both the electric motor and gas engine can (обеспечить) propulsion power. 8. Hybrid cars use special (шины) that are both stiffer and inflated to a higher pressure than conventional (шины).

**Упр. 5. Выберите правильное определение для каждого данного слова и переведите их на русский язык.**

generator, gasoline, electricity, submarine, hybrid, emission.

1. ship that can be used under the surface of the sea.
2. all the phenomena associated with electrons (negative charge) and protons (positive charge).

3. machine or apparatus that generates, produces (electricity, steam, gas, vapour, energy).
4. something that consists of or comes from a mixture of two or more other things.
5. a liquid obtained from petroleum, used mainly for producing power in the engines of cars.
6. a gas or other substance that is sent into the air.

**Упр. 6. Выберите правильный перевод словосочетаний, где слово "TRANSMISSION" является определяющим.**

- |                                     |  |
|-------------------------------------|--|
| 1. lever transmission               | а) бесступенчатая коробка передач                  |
| 2. belt transmission                | б) дифференциальная передача                       |
| 3. hydraulic transmission           | в) коробка передач с двумя промежуточными валами   |
| 4. infinitely variable transmission | г) ступенчатая коробка передач                     |
| 5. twin countershaft transmission   | е) коробка передач с промежуточным валом           |
| 6. chain transmission               | ф) ременная передача (привод)                      |
| 7. gear transmission                | г) бесступенчатая коробка передач, вариатор        |
| 8. differential transmission        | д) передача со свободным ходом                     |
| 9. fixed-ratio transmission         | е) рычажная передача                               |
| 10. manual transmission             | ж) зубчатая передача, коробка передач с шестернями |
| 11. stepless transmission           | з) трансмиссия с гидротрансформатором              |
| 12. countershaft transmission       | и) гидропривод                                     |
| 13. free transmission               | к) коробка передач с ручным управлением            |
| 14. torque-converter transmission   | л) цепная передача                                 |

**Упр. 7. Переведите предложения на русский язык, обращая внимание на употребление многофункционального слова “that”.**

1. The car night vision system uses a camera that can be placed close to the driver's head. 2. The reality of today is that the automobile engineer should know about more than just mechanical engineering. 3. Besides the fuel consumption of a diesel is much less than that of gasoline engine. 4. The company presents a climatic wind tunnel that the company regards as the most technically advanced of its type in the world. 5. The weight of diesel engines is more than that of a gasoline engine of the same power and it occupies much space. 6. Another important problem is that of fuel. 7. The steering spindles are that part of the front axle on which the front wheels revolve.

**Упр. 8. Переведите предложения на русский язык, обращая внимание на перевод герундия.**

1. One of the main problems of a driver on the road is keeping the speed constant and watching the cars ahead. 2. Monitoring and adjusting air pressure in tyres is one of the newest developments of the car designers. 3. Detecting an object in front of a car in the dark is the purpose of the “night vision” system. 4. On detecting danger on the road, the computer signals the driver. 5. One of the best ways of keeping the speed steady is using the computer for this purpose. 6. On being turned on the radar will warn the driver about the stationary or slow-moving objects on the road. 7. The function of a car computer is detecting and summing up the information about the road conditions. 8. The white line in the center of the road is one of the most effective means of controlling traffic. 9. A driver may avoid collisions on the road by using a radar system.

**Упр. 9. Переведите предложения на русский язык, обращая внимание на перевод инфинитива.**

1. This in-house system is designed to meet the needs of turbocharged engines. 2. The correct wood detail to match the car is achieved by a careful matching of the veneers. 3. The events to be analyzed are the actions taken during the operation of a car. 4. A small battery is used to power accessories and provide a boost during hand acceleration. 5. Lord Montagu’s farther was the first person in England to be fined by



the police for speeding. 6. To ensure maximum safety for the transportation system, it is necessary to plan and design highways on sound engineering techniques.

**Упр. 10. Переведите предложения на русский язык, обращая внимание на перевод инфинитивного оборота “сложное дополнение”.**

1. There’s a special knob on the centre console that enables you to choose of one of the five settings: general driving, slippery conditions and three special off-road modes. 2. This in-house system allows Saab to carry out a speedier, more effective development work. 3. Certain tests may require the test vehicle to be equipped with particular devices to ensure reliable results. 4. Differential is the device that permits the rear wheels to revolve at different speeds independently on of the other. 5. The scientists considered hands-free equipment to be significantly less risky to use than hand-held mobile phones while driving.

**Упр. 11. Заполните таблицу, образуя указанные части речи.**

Verbs	Adjectives	Nouns
...	transmissible	transmission
...	...	power
...	...	engine
drive	...	...
...	rechargeable	....
...	...	replacement
install	...	
...	ignition	...

**Упр. 12. Переведите цепочки однокоренных слов.**

1. mean – meaning – means – meaningful
2. move – moving – moved - movement
3. adapt – adapted – adapting – adaptable – adaptability – adaptation.
4. achieve – achievement – achieved – achievable

5. energy – energize – energized – energetic
6. charge – chargeable – recharge – rechargeable – discharge – dischargeable
7. electrify – electrified – electric – electrical - electrification

**Упр. 13. Прочитайте текст. Сократите его до 1/3, оставив наиболее важную информацию для составления реферативного перевода.**

Currently, Honda and Toyota have the technology that might answer all of the customers needs like the high price of gasoline or the contribution to the greenhouse effect. It's the hybrid car, and both manufacturers are selling their versions in the United States. In fact, most automobile manufacturers have announced plans to manufacture their own versions.

Any vehicle is a hybrid when it combines two or more sources of power. In fact, many people have probably owned a hybrid vehicle. For example, a moped (a motorized pedal bike) is a type of hybrid because it combines the power of a gasoline engine with the pedal power of its rider.

Hybrid vehicles are all around us. Most of the locomotives we see pulling trains are diesel-electric hybrids. Giant mining trucks are often diesel-electric hybrids. Submarines are also hybrid vehicles - some are nuclear-electric and some are diesel-electric. Any vehicle that combines two or more sources of power that can directly or indirectly provide propulsion power is a hybrid.

Hybrid structure

You can combine the two power sources found in a hybrid car in different ways. One way, known as a parallel hybrid, has a fuel tank, which supplies gasoline to the engine. But it also has a set of batteries that supplies power to an electric motor. Both the engine and the electric motor can turn the transmission at the same time, and the transmission then turns the wheels.

In a typical parallel hybrid you'll notice that the fuel tank and gas engine connect to the transmission. The batteries and electric motor also connect to the transmission independently. As a result, in a parallel hybrid, both the electric motor and the gas engine can provide propulsion power.

By contrast, in a series hybrid the gasoline engine turns a generator, and the generator can either charge the batteries or power an elec-

tric motor that drives the transmission. Thus, the gasoline engine never directly powers the vehicle.

Hybrid cars contain the following parts: gasoline engine, fuel tank, electric motor, generator, batteries and transmission. The hybrid car has a gasoline engine much like the one you will find on most cars. However, the engine on a hybrid is smaller and uses advanced technologies for reducing emissions and increasing efficiency.

The fuel tank in a hybrid is the energy storage device for the gasoline engine. Gasoline has a much higher energy density than batteries do. For example, it takes about 1,000 pounds of batteries to store as much energy as 1 gallon (7 pounds) of gasoline.

The electric motor on a hybrid car is very sophisticated. Advanced electronics allow it to act as a motor as well as a generator. For example, when it needs to, it can draw energy from the batteries to accelerate the car. But acting as a generator, it can slow the car down and return energy to the batteries. The generator is similar to an electric motor, but it acts only to produce electrical power. It is used mostly on series hybrids.

The batteries in a hybrid car are the energy storage device for the electric motor. Unlike the gasoline in the fuel tank, which can only power the gasoline engine, the electric motor on a hybrid car can put energy into the batteries as well as draw energy from them.

The transmission on a hybrid car performs the same basic function as the transmission on a conventional car. Some hybrids, like the Honda Insight, have conventional transmissions. Others, like the Toyota Prius, have radically different ones.

The reason for building such a complicated machine - when most people are perfectly happy with their gasoline-powered cars - is twofold: to reduce tailpipe emissions and to improve mileage. The amount of pollution allowed does not depend on the mileage your car gets. But a car that burns twice as much gas to go a mile will generate approximately twice as much pollution. That pollution will have to be removed by the emissions control equipment on the car. So decreasing the fuel consumption of the car is one of the surest ways of decreasing emissions.

The key to a hybrid car is that the gasoline engine can be much smaller than the one in a conventional car and therefore more efficient. The gas engine on a conventional car is sized for the peak pow-

er requirement In fact, most drivers use the peak power of their engines less than one percent of the time. The hybrid car uses a much smaller engine, one that is sized closer to the average power requirement than to the peak power.

**Упр. 14. Выполните письменный перевод следующего текста.**

Toyota has named its gasoline-electric hybrid car Prius. The Prius is **Japan's first, and one of the world's first, series production** internal-combustion engine/electric motor-driven passenger cars. Prius, according to Toyota, means **"pioneering" in Latin. The Prius employs a parallel** hybrid system, using both the internal combustion engine and electric motor for propulsion. Toyota, by the way, preceded the Prius with a series hybrid vehicle, an electrically driven mini bus. The main purpose of its gasoline engine is generating electricity and recharging the batteries. The engine 1 NZ-FXE has dual overhead camshaft, 16 valves, inline four cylinders and it was designed for the hybrid application. It is an extremely compact unit to be installed inline with the electric motor and CVT. The VVT-1 improves low- and middle-speed torque and fuel economy, and reduces exhaust emissions and minimizes power train vibrations during engine start-up (the vehicle normally moves off on electric power, and the engine comes in when accelerating).

**Упр. 15. Составьте реферативный пересказ об основных составляющих и преимуществах гибрида, используя следующие выражения:**

The text is concerned with.... ... are considered. It should be noted that.... The fact that...is stressed. It should be remembered that... .I find the text rather/very ...

Unit 8

Internal Combustion Engine Valves and Valve Train

**Упр. 1. Запомните новые слова и выражения и их значения.**

1. air-pumping capacity – производительность воздушного насоса
2. cam-follower=valve-lifter – толкатель клапана
3. seat – седло клапана
4. capacity – способность, мощность, производительность

5. convex(adj) – выпуклый
6. draw(v) in - втянуть, втащить
7. jacket – чехол, кожух, рубашка
8. helical spring – цилиндрическая пружина
9. inward-opening poppet valve type – клапан тарельчатого типа, открывающийся вовнутрь
10. lever – рычаг, коромысло
11. linkage – сцепление, рычажный механизм
12. non-scaling – не деформирующийся
13. pivot(v) – вращать(ся) вокруг своей оси
14. poppet valve – тарельчатый клапан
15. push rod – штанга толкателя клапана
16. reciprocating pump – поршневой насос
17. reciprocation engine – поршневой двигатель
18. rocker arm – рокер, рычаг клапана (зд. коромысло)
19. tightness – непроницаемость, герметичность
20. valve guide – направляющая клапана
21. valve head ground – основание головки клапана
22. valve stem – стержень (шток) клапана
23. valve train – клапанный механизм

**Упр. 2. Прочтите и переведите интернациональные слова.**

Temperature, diameter, type, automotive, effect, extreme, design, to construct, metal, mechanism, mechanical, minute, to combine, cylinder, conical, block, distance, effective, roller, to activate, standard, automobile, operator, center.

**Упр. 3. Переведите предложения на русский язык обращая, внимание на новые слова.**

1. Poppet valves are cooled by transferring heat to the engine jacket, mostly through the valve stem. 2. Mechanically, an internal combustion engine is a reciprocating pump, able to draw in a certain amount of air per minute. 3. In most four-stroke engines, the valves are of the inward-opening poppet type, with the valve head ground to fit a conical seat in the cylinder block or cylinder head. 4. A follower or valve-lifter is riding on each cam, which may be a flat or slightly convex surface. 5. By valve train, we mean the valves and valve-operating mechanism by which the fuel/air mixture is taken into the cylinders and the combustion products

are discharged to the exhaust. 6. The operating linkage consists of cam follower, push rod and rocker arm.

**Упр. 4. Переведите выделенные слова на английский язык, используя активный словарь урока.**

1. (Головка клапана) is held concentric with its seat by a cylindrical (шток) running in the (направляющая клапана) 2. Since the fuel takes up little space but needs air with which to combine, the power output of an engine is limited by its (производительность воздушного клапана). 3. (Тарельчатые клапаны) are generally 2 inches in diameter or smaller. 4. (Выхлопные клапаны) are subject to the effects of extreme temperature and must be most carefully designed. 5. (Клапан) is opened by forces applied to the end of the (шток клапана) through a mechanical linkage activated by the (толкателем клапана). 6. (Шток толкателя клапана) is a light rod or tube with ball ends which carries the motion of the (толкателя кулачка) to the (коромысло). 7. (Коромысло) is a lever, pivoted near its center.

**Упр. 5. Выберите правильное определение для каждого данного слова и переведите их на русский язык.**

crankshaft, jacket, internal combustion engine, diesel engine, valve.

1. a part of a tube or pipe that opens and shuts like a door to control the flow of air, gas, liquid passing through it.
2. a cover that surrounds and protects some type of machines.
3. an engine that produces power by burning petrol used in most cars.
4. oil-burning engine in which ignition is produced by the heat of suddenly compressed gas.
5. a long piece of metal in a vehicle that is connected to the engine and helps to turn the wheels.

**Упр. 6. Выберите правильный перевод словосочетаний, где слово "VALVE" является определяющим.**

- |                   |                                 |
|-------------------|---------------------------------|
| 1. poppet valve   | a) выпускной (выхлопной) клапан |
| 2. metering valve | b) клапан с кулачковым приводом |
| 3. intake valve   | c) обратный клапан              |
| 4. throttle valve | d) шаровой клапан               |

- |                           |                                    |
|---------------------------|------------------------------------|
| 5. ball valve             | е) дроссельная заслонка            |
| 6. conical (seated) valve | ф) наклонно расположенный клапан   |
| 7. flat valve             | г) тарельчатый клапан              |
| 8. tappet valve           | h) дозирующий клапан               |
| 9. exhaust valve          | и) инжекторный клапан              |
| 10. muffler cutout valve  | ж) пластинчатый клапан             |
| 11. back-pressure valve   | к) поворотная дроссельная заслонка |
| 12. rotary throttle valve | л) впускной клапан                 |
| 13. sloping valve         | м) клапан выключения глушителя     |
| 14. injection valve       | н) клапан с коническим седлом      |

**Упр. 7. Переведите предложения на русский язык, обращая внимание на перевод прилагательных.**

1. Vehicle design at the concept stage can result in optimum radiator location and frontal area as well as necessary mounting provision. 2. For comfort, the optimum damping should be as low as possible, and for safety the damping should be higher at high damper velocity. 3. The closer integration of the new engines and transmission has given a far more sophisticated and refined level of performance. 4. Mercedes-Benz is the world's biggest maker of trucks, a leading van manufacturer and one of the world's largest builders of buses. 5. One of the biggest contributors to increased fuel efficiency is the all-aluminium block. 6. The lighter vehicle could use smaller and lighter springs and shocks. 7. Two of the biggest benefits are its remote maintenance and diagnostic features. 8. Though weighing significantly less, variable single seats in the rear of the V-class provide even greater comfort and even more safety.

**Упр. 8. Переведите предложения на русский язык, обращая внимание на употребление многофункционального слова "since".**

1. Since the end of the World War II there has been a rapid development of jet engines. 2. The fuel economy improvement is considered relative to other means of improving economy, since weight reduction is not easy to achieve. 3. Since the first electric car appeared many changes have

taken place in the field of automobile industry. 4. Since the jet engine is a powerful source of energy, it is widely used for machines flying at supersonic speed. 5. In early days many of the cars broke since transmission were still unreliable and often went out of operation. 6. Since conventional headlights are not very effective, a new system has to be developed.

**Упр. 9. Переведите предложения на русский язык, обращая внимание на перевод глаголов в пассивном залоге.**

1. The camshaft is placed in the crankcase. 2. Poppet valves are used almost exclusively in internal combustion reciprocation engines. 3. The valve is opened wide by lifting it from its seat a distance equal to 25% of the valve diameter. 4. Valves are usually made of a stainless alloy which will keep its shape at high temperature. 5. The ignition system is divided into two circuits, low tension and high tension. 6. Two valves per cylinder are mounted vertically in the cast iron cylinder head. 7. The camshaft is supported by three bearings located directly in cylinder block. 8. As the engine operates, the valves are successively opened and closed. 9. The gas engine was greatly improved by the use of liquid fuels. 10. Engine valves are usually opened by means of cams.

**Упр. 10. Переведите предложения на русский язык, обращая внимание на перевод причастия.**

1. The design draws heavily on advanced research being conducted by Ford Advanced Vehicle Technology and its wealth of experience gained from motosports. 2. This is the biggest produced development programme carried out in Saab's history. 3. Honda knows the significance of the fast-growing C-segment diesel market. 4. Positioned in a market niche between conventional road-going cars and classic off-road vehicles, allroaders are gaining increasing importance. 5. Having decided to develop it own Research and Development Department, the company has produced some highly successful products over the years. 6. The axle shaft of the outside wheel being attached to the wheel, must revolve faster than the axle shaft of the inside wheel when turning to the right, and slower if turning to the left.



**Упр. 11. Заполните таблицу, образуя указанные части речи.**

VERB	NOUN	ADJECTIVE
....	design	...
....	...	constructive
compress	...	....
...	requirement	
...	...	strong
power	...	...
...	follower	...
...	...	applicable
link	...	...
activate	...	...
...	pivot	...
...	...	effective

**Упр. 12. Переведите цепочки однокоренных слов.**

1. associate – association – associated – associative
2. vary - variable – variety – variant – various
3. compete – competition – competitor – competitive – compatibility
4. simulate – simulated – simulator – simulation
5. convert – converter – conversion – convertible – convertibility
6. emit – emitted – emission – emissive
7. sense – senseless – sensibility – sensible – sensitive – sensor

**Упр. 13. Прочитайте и переведите текст. Обратите внимание на перевод атрибутивных сочетаний (N+N), в которых главным является последнее слово.**

Poppet valves are used almost exclusively in internal combustion reciprocation engines because of the demands for tightness with high operating temperatures and pressures. The valves are generally 2 inches in diameter or smaller on high-speed automotive-type engines. They are cam-operated and spring-loaded. They are cooled by transferring heat to the engine jacket, mostly through the valve stem. Exhaust valves are subject to the effects of extreme temperature and must accordingly be most carefully designed and constructed of alloy metals.

By valve train, we mean the valves and valve-operating mechanism by which an internal combustion engine takes air or a fuel-air mixture into the cylinders and discharges the combustion products to the exhaust. Mechanically, an internal combustion engine is a reciprocating pump, able to draw in a certain amount of air per minute. Since the fuel takes up little space but needs air with which to combine, the power output of an engine is limited by its air-pumping capacity.

It is essential that the flow through the engine can be restricted as little as possible. This is the first requirement for valves. The second is that they close off the cylinder during the compression and power strokes.

In most 4-stroke engines, the valves are of the inward-opening poppet type, with the valve head ground to fit a conical seat in the cylinder block or cylinder head.

The valve head is held concentric with its seat by a cylindrical stem running in the valve guide. The valve is held closed by a compressed helical spring. The valve is opened wide by lifting it from its seat a distance equal to approximately 25% of the valve diameter. Valves are usually made of a stainless, non-scaling alloy which will keep its strengthened shape at high temperature. Exhaust valves sometimes are made hollow and partially covered with metallic sodium to permit more effective cooling.

Engine valves are usually opened by means of cams.

A follower or valve-lifter is riding on each cam. It may be a flat or slightly convex surface, or a roller. The valve is opened by forces applied to the end of the valve stem through a mechanical linkage activated by the cam follower. The camshaft placed in the crankcase is usual in standard automobiles. The operating linkage consists of cam follower, push rod and rocker arm. The push rod is a light rod or tube with ball ends which carries the motion of the cam follower to the rocker arm. The rocker arm is a lever, pivoted near its centre so that as the push rod raises one end, the other end depresses the valve stem, opening the valve.

#### **Упр. 14. Выполните письменный перевод следующего текста.**

The engine that is fitted to all models in the Ford Fiesta is the four cylinder overhead valve engine, available in the following versions: 950 cc,

1100 cc, 1300 cc and 1600 cc. Variations in capacity are achieved by different crankshaft strokes and connecting rod length. All units are similar in design and different only in the size of certain components and the number of main bearings. Two valves per cylinder are mounted vertically in the cast iron cylinder head and run in valve guides. They are operated by rocker arms, push rods and cam follower which is located at the base of the cylinder bores in the right hand side of the engine. The correct clearance of valve stem to rocker arm pad (**колодка**) can be obtained by the adjusting screws in the ends of the rocker arms. The cylinder block and upper half of the crankcase are cast together with the open half of the crankcase.

**Упр.15. Составьте аннотацию текста “Internal Combustion Engine Valves and Valve Train”, используя следующие выражения:**

The text deals with ... It draws our attention to ... Of special interest is the fact that ... It is specially noted that ...

## Unit 9

### The Light Green Powerhouse

**Упр. 1. Запомните новые слова и словосочетания и их значение.**

1. air-gap insulated manifold – изолированный патрубок с воздушным промежутком
2. bulkhead – поперечно расположенный (перемычка, перегородка)
3. coupe - купе
4. cracking process – процесс крекинга (образования трещин)
5. crankcase – картер двигателя
6. cure(v) – исправлять, устранять
7. cylinder liner – гильза цилиндра
8. cylinder bank – блок цилиндров
9. dual ignition – двойное зажигание
10. ignition timing – опережение зажигания
11. inherent drawbacks – присущие недостатки
12. intake/exhaust manifold – впускной/выхлопной коллектор
13. misfiring – перебои в зажигании
14. part load – частичная нагрузка
15. power output – выходная мощность

16. powerplant – силовая установка
17. ram pipe – прямоточная труба
18. retain (v) – сохранять, удерживать
19. roller-type rocker arm – коромысло роллерного типа
20. sheet steel – листовая сталь
21. shut off - выключение
22. smooth(adj) – плавный, однородный
23. torque – крутящий момент
24. throttle valve – дроссельный клапан

**Упр. 2. Прочтите и переведите интернациональные слова.**

Detail, model, technical, technology automatic, modern, design, process, aluminum, magnesium, laser, emission, mechanism, microcomputer, control, harmonious, period, catalytic, to identify, to control, standard, to deactivate, maximum, efficiency, hydraulic, sensor, special, diagnostic system.

**Упр. 3. Переведите предложения на русский язык обращая, внимание на новые слова.**

1. The technical features of this 5,789 cc powerplant are known to have a power output of 367 ps (270 kW) at 5,500 rpm and an impressive torque of 530 Nm. 2. The crankcase is made of aluminium, with magnesium used for the intake manifold. 3. The new engine can instantly identify and cure any misfiring, which helps protect the catalytic converters. 4. Each cylinder bank features two bulkhead catalytic converters. 5. Automatic cylinder shut-off is expected to interrupt the link between the valves and camshaft hydraulically by locking the valve control arms. 6. One camshaft in each of the two cylinder banks operates the valves via low-friction roller-type rocker arms.

**Упр. 4. Переведите выделенные слова на английский язык, используя активный словарь урока.**

1. This includes (двойное зажигание), three valve technology, automatic (выключение цилиндра) and low friction (гильзы цилиндра). 2. The (выхлопной коллектор) is made of laser welded, high-pressure formed (листовая сталь). 3. Because of the three valve technology and the (изолированный коллектор с воздушным промежутком) the (попе-

речно расположенный катализатор) reaches its operating temperature just a few seconds after the engine is started from cold. 4. During (частичной загрузки) operation this cures the (присущие недостатки) of large-displacement engines. 5. (Выпускные клапаны) help reduce heat loss inside the engine. 6. (Плавность) and low noise emissions are fully retained during (выключение цилиндра).

**Упр. 5. Выберите правильное определение для каждого данного слова и переведите их на русский язык.**

coupe, cylinder, camshaft, valve, friction, throttle valve.

1. a car with two doors and a sloping back.
2. when one surface rubs against another; the natural force that prevents one surface from sliding easily over another surface.
3. a part of a tube or pipe that opens and shuts like a door to control the flow of air, gas, liquid passing through it.
4. shaft to which cams are attached.
5. the tube within which a piston moves towards and backwards in an engine.
6. valve controlling the flow of steam, petrol, vapour in an engine.

**Упр. 6. Переведите предложения на русский язык, обращая внимание на употребление многофункционального слова “as”.**

1. As airbags were added for frontal and side impact, more crash sensors and accelerometers were added to control airbag deployment. 2. As the concern for front seat passengers has grown so has the need for sensors if the passenger airbag needs to deploy. 3. As engineers have moved beyond antilock braking and traction control into electronic stability control (ESC), more sensors are required. 4. As more sensors become electronic or digital, they are interconnected and their output is used for more than one vehicle system. 5. To attract the best and the brightest, the industry needs to project an image of the automotive engineer as someone with skills and knowledge beyond mechanical engineering. 6. The modern automobile has often been described as a computer on wheels. 7. In 1997, Michelin made automotive history as the first tire company to offer zero-pressure or run-flat tires. (шины, обеспечивающие движение с нулевым давлением). 8. As a result air-conditioning is now standard on most new vehicles in the USA.

**Упр. 7. Переведите предложения на русский язык, обращая внимание на перевод инфинитивного оборота “сложное подлежащее”.**

1. The principle of lightweight design is certain to be evident for Mercedes cars. 2. The cylinder liners are reported to provide additional weight savings up to 46 percent compared with the previous V12 engine. 3. The three-valve technology is also known to have helped in weight loss. 4. The new engine proves to be controlled by an innovative alternating current ignition system. 5. The deactivated combustion chamber is noticed to become fully operational once the accelerator is pushed. 6. One of the most noticeable technical feature of the new V12 engine is considered to be its exhaust system. 7. Emissions for the engine comply with Euro 4 is concluded to be introduced next year. 8. The ignition system is sure to be controlled both mechanically and by a vacuum operated system. 9. The transmission assembly is known to consist of the clutch, gearbox, final drive and several other units. 10. All models are supposed to use a floor mounted handbrake (parking brake) lever located between the front seats.

**Упр. 8. Переведите предложения на русский язык, обращая внимание на перевод герундия.**

1. The car doesn't give the impression of being huge and heavy. 2. Apart from its striking design and functionality, the Eclipse 2006 has incredible power and easy handling. 3. Modifying and fine-tuning the vehicle's suspension system made the Porsche 911 the best sport car. 4. Although the risk of being involved in a traffic accident is the same for motorists as compared to other road users, the risk of a motorcyclist being injured in an accident much higher. 5. GM stated that meeting the wishes and needs of European drives was the first priority in designing the car. 6. The first engine appeared in the 17<sup>th</sup> century and people began using them to operate factories, irrigate lands, supply water to towns.

**Упр. 9. Переведите цепочки однокоренных слов.**

1. product – produce – produced – production – productive – productivity
2. separate – separation – separated – separately – separator
3. note – notice – noticeable – noticeably
4. advance – advantage – advantageous – disadvantage
5. occupy – occupier – occupation – occupational – occupant

6. imply – implicate – implication – implicit
7. attract - attractable –attractive –attraction – disattraction

**Упр. 10. Образуйте существительные и переведите их .**

-sion:	to divide, to convert, to explode, to activate, to compress, to emit, to transmit, to provide
-er:	to drive, to boil, to contain, to convert, to condense, to roll to follow to research
-ance:	to resist, to appear, to assist, to perform
-ence:	to depend, to differ, to exist, to occur
-ity:	electric, resistive, active, productive, possible, dense

**Упр. 11. Образуйте прилагательные и переведите их.**

-ive:	to effect, to act, to respect, induction, to affect, to alternate
-ful:	use, power, help, wonder, care
-less:	power, weight, motion, stain, effect
-ent:	to differ, to insist

**Упр. 12. Прочитайте и переведите текст, обращая внимание на перевод инфинитивных конструкций.**

Mercedes-Benz has shown details of its new V12 engine which is stated to be intended to go into the S-Class.

The technical features of this 5,789 cc powerplant are known to have a power output of 367 ps (270 kW) at 5,500 rpm and an impressive torque of 530 Nm available from 4,250 rpm. These technical features are reported to include dual ignition, three-valve technology, automatic cylinder shut-off, low-friction cylinder liners and modern lightweight design. It is sure to have a significant improvement on fuel economy.

The principle of lightweight design of Mercedes cars is certain to be evident: the new V12 weighs 222 kg. This is known to have been achieved by modern construction processes and intelligent material selection. The crankcase is made of aluminium, with magnesium used for the intake manifold, while the exhaust manifold is made of laser-welded, high-pressure formed sheet steel. Cylinder liners are said to use a special

aluminium-silicon alloy and connect rods manufactured in the so-called cracking process. They are also claimed to provide additional weight savings.

The three-valve technology is also known to have helped in weight loss, although its main advantages really revolve around fuel consumption and exhaust emissions.

One camshaft in each of the two cylinder banks operates the valves via low-friction roller-type rocker arms. A microcomputer-controlled adjustment mechanism is suggested to adapt camshaft control times to the appropriate road conditions, so help harmonious torque development, which is further followed by the complex geometry of the innovative ram pipe. Removing one of the outlet valves helps reduce heat loss inside the engine and creates the space to introduce two spark plugs for each combustion chamber.

The new engine proves to be controlled by an innovative alternating current ignition system. It can instantly identify and cure any misfiring, which helps protect the catalytic converters.

The V12 engine's standard cylinder shut-off system is mentioned to deactivate valve actuation and fuel injection for an entire cylinder bank when only part of the maximum output of torque is needed. During part-load operation this cures the inherent drawbacks of large-displacement engines, namely inadequate filling of the cylinder, low cylinder pressure and greater friction, which in turn adversely affect efficiency and fuel consumption. So smooth is the shut-off due to the electronic engine management system changing the throttle valve position and adjusting the ignition timing to prevent any sudden jump in torque, that it remains totally unnoticeable by the passengers. The deactivated combustion chambers are noticed to become fully operational once the accelerator is pushed.

Smoothness and low noise emissions are proved to be fully retained during cylinder shut-off. A valve in the mixing tube, leading to the underfloor catalytic converters, closes immediately when six of the 12 cylinders are shut off to prevent higher pressure waves occurring in the exhaust system. Automatic cylinder shut-off is expected to interrupt the link between the valves and camshaft hydraulically by locking the valve control arms. At the same time fuel supply and ignition on the left cylinder bank seem to be shut off.



Another technical feature of the new V12 engine is considered to be its exhaust system: a total of six catalytic converters - four bulkhead catalysts plus two underfloor catalysts - and eight oxygen sensors reliably ensure that exhaust gas pollutants are purified.

Each cylinder bank has two bulkhead catalytic converters. Because of the three-valve technology and the air-gap insulated exhaust manifold the bulkhead catalytic converters is certain to reach their operating temperature just a few seconds after the engine is started from cold. Oxygen sensors are expected to monitor emissions going to and from the bulkhead converters. The data they provide is evaluated not only by the engine control unit but also by a special onboard diagnostic system. Emissions for the engine are concluded to comply with Euro 4.

**Упр. 13. Выполните письменный перевод следующего текста.**

VW's NEW POLO has the new gasoline direct injection 1.4-litre four cylinder engine which was first seen in the Lupo at the IAA show in Frankfurt in September. Available in three states of tune - 60 ps (44 kW), 75 ps (55 kW) and 100 ps (74 kW) - it features Bosch's MED 7 Motronic engine management system. Bosch is the first European manufacturer of such a system for direct injection engines that work according to the stratified charge principle (**принцип накопления заряда**). Not only does this technology provide elastic, efficient and particularly dynamic - gasoline engines, it also has significant advantages in terms of consumption: depending on the load and engine speed, the Bosch system allows a reduction in consumption of fuel between 15 and 20 per cent - as measured in the European driving cycle for passenger cars - compared with conventional intake manifold injection systems. Unlike simpler systems, in which the engine is converted to direct injection but is only operated in stratified charge mode to a very limited extent. Bosch fully uses the savings potential of direct injection with this sophisticated concept: more than 70 per cent of road load (according to the European driving cycle) can be covered in the economical stratified charge range.

**Упр. 14. Составьте аннотацию текста о двигателе V12, используя следующие выражения:**

The text is concerned with ... . ... are considered. It should be noted that ... . The fact that ... is stressed. It should be remembered that ... .

## Unit 10

### Lexus SC 430

#### **Упр. 1. Запомните новые слова и выражения и их значения.**

1. air bag – воздушная подушка
2. acceleration performance – динамический показатель (время разгона)
3. brake pedal – педаль тормоза
4. gate – кулиса
5. maintain(v) - поддерживать
6. pressure – давление
7. pretensioner – предварительный натяжитель
8. race car – гоночный автомобиль
9. rear-wheel drive – заднеприводный
10. semi-manual shifting – ручное полуавтоматическое переключение
11. slippery – скользкий
12. seat belts – ремни безопасности
13. skidding – занос, пробуксовывание
14. steer(v) - управлять
15. tire - шина
16. torque – крутящий момент
17. traction control – регулировка тягового усилия
18. wheel spin – пробуксовывание колеса

#### **Упр. 2. Прочтите, запомните перевод следующих сокращений.**

1. EBD (Electronic Brake-Force Distribution) – электронное распределение тормозной силы
2. VSC (Vehicle Skid Control) – контроль транспортного средства при заносе
3. mph (miles per hour) – миль в час
4. ABS (Anti-lock Braking system) – анти-блокировочная система
5. 5 rpm (revolutions per minute) – обороты в минуту
6. ESP (Electronic Stability Program) – программа электронной стабильности
7. AWD (All Wheel Drive) – привод на все колеса
8. SUV (Sport Utility Vehicle) – спортивный автомобиль
9. ASR (Anti-Slip Regulation) – антипробуксовочная система

### **Упр. 3. Прочтите и переведите интернациональные слова.**

Comfortable, automatic, transmission, console, active, physical, technology, pedal, balance, resource, problem, proportion, universal, battery, indicator, energy, central, signal, project, acceleration, distance.

### **Упр. 4. Переведите предложения на русский язык обращая внимание на новые слова.**

1. The semi-manual gearshift can sense changes in engine performance. 2. The V8 engine with double-overhead cam produces 300 hp at 5600 rpm. 3. The five-speed automatic transmission shifts smoothly. 4. Active safety system includes ABS, EBD, traction control, VCS and Brake Assist. 5. When you suddenly take a maneuver, press down firmly on the brakes and steer in the direction you want to go and maintain hard pressure on the brake pedal. 6. Electronic Brake Force Distribution maintains the proper balance of braking force to all four tires.

### **Упр. 5. Переведите выделенные слова на английский язык, используя активный словарь урока.**

1. The Lexus SC 430 has excellent (ремни безопасности) and side-impact (воздушная подушка). 2. ABS prevents brakes from locking up so that the driver (поддерживает) steering control. 3. The Lexus is not intended to be driven like (гоночный автомобиль). 4. The car has a very flexible engine with strong (крутящий момент) at low rpm so it's always ready to deliver smooth power. 5. The 18-inch (литые диски) are fitted with Dunlop summer tyres. 6. Brake Assist helps (поддерживать) hard pressure on the (педаль тормозов) when the system detects the driver is making mistake of relaxing (давление) on the brake pedal. 7. (Регулирование тягового усилия) reduces (пробуксовывание задних колес) when accelerating on (скользкой) surfaces. 8. The shifter has a C-shaped (кулилка) allowing (полуавтоматическое переключение). 9. (Динамические показатели) of Lexus SC is comparable to that of Mercedes and Jaguar. 10. (Самая высокая скорость) is about 156 mph more than fast enough.

**Упр. 6. Выберите правильный перевод словосочетаний, где слово "DRIVE" является определяющим .**

- |                                |   |
|--------------------------------|---|
| 1. cam drive                   | a) кулисный привод                                |
| 2. variable-speed drive        | b) сервопривод                                    |
| 3. single camshaft chain drive | c) передача двумя валами                          |
| 4. link drive                  | d) реечная передача                               |
| 5. universal-joint drive       | e) червячная передача                             |
| 6. servo drive                 | f) кулачковый [эксцентриковый] привод             |
| 7. rack-and-pinion drive       | g) передача от полуоси к колесу                   |
| 8. quill drive                 | h) передача с плавно регулируемым числом оборотов |
| 9. worm gear drive             | i) карданный привод                               |
| 10. double shaft drive         | j) передача в заднем мосте                        |
| 11. hub drive                  | k) ординарный цепной привод распределителя        |
| 12. rear-axle drive            | l) передача с полым валом                         |

**Упр. 7. Выберите правильное определение для каждого данного слова и переведите их на русский язык.**

maneuver, horsepower(hp), steer(v), interior transmission, safety valve, air-bag.

1. the inner part or inside of the car.
2. the parts of a vehicle that take power from the engine in the wheels.
3. a unit for measuring the power of an engine.
4. a part of a machine that allows gas, steam etc. to escape when the pressure becomes too great.
5. a skilful or careful movement that you make, for example in order to avoid something or go through a narrow space.
6. to control the direction a vehicle is going, for example by turning a wheel.
7. a bag in a car, that fills with air to protect the driver or passenger in an accident.

**Упр. 8. Переведите предложения на русский язык, обращая внимание на употребление многофункционального слова “one”.**

1. A universal joint is a flexible connection between two shafts, which permits one to drive another. 2. The cost of a heavier fuel is much less than that of a light one. 3. One more important problem worked at by the designers is the engine reliability. 4. Ford cars are equipped with an electronic instrument panel that calculates how far one can drive on the fuel left in the tank. 5. One assumes that lots of people were impressed by the new of Mercedes presented at the show. 6. One of many systems, affecting customer satisfaction and environmental impact, is air-conditioning.

**Упр. 9. Переведите предложения на русский язык, обращая внимание на перевод инфинитива.**

1. One of the best ways to keep the car speed steadily is to use a computer. 2. A special electronic device signals the engine to stop. 3. Radar may control the brakes to avoid collisions with other cars. 4. High temperature alloys make it possible for jet engines to be operating under severe conditions for a long period of time. 5. Recently a radar to be mounted on cars has been developed. 6. In a new Japanese car the information to be received by the driver will come through a navigation earth satellite. 7. The radar detects the stationary objects ahead of the car to warn the driver about the danger and slow down the speed. 8. There remains one more test to be carried out before using the device. 9. In internal combustion engines the pressure of gases **forces the piston to go down.** 10. **The “night vision” system is to be** small enough to be used in automobiles. 11. Infrared rays emitted by any object on the road are to be intensive enough for sensors to pick them up. 12. The Voice Warning system for cars requires the connection of 18 wires, but it is simple enough to be installed in a car.

**Упр. 10. Переведите предложения на русский язык, обращая внимание на перевод инфинитивного оборота “сложное подлежащее”.**

1. On tests Golf proved to be well built, spacious for its size. 2. The sedan version is supposed to be the fastest way of finding new customers. 3. Diesel sales are expected to make up some 70 percent of Superb sales. 4. The reality of today is that the automotive engineer is expected to know about far more than just mechanical engineering. 5.

Audi 2 is claimed to be the world's first aluminium car to be signed off for volume production. 6. Parents who were more liberal concerning traffic rules were also more likely to allow their children to travel without safety belt. 7. People's emotions are stated to play the most important role in the purchase of their automobile.

**Упр. 11. Образуйте от данных слов слова с противоположным значением, используя суффиксы, и переведите их.**

un-:	desirable, solved, natural, limited, able, noticeable
non-:	metallic, ferrous, breakable
in-:	complete, ability, expensive, effective, convertible, adequate
im-:	possible, permanent, measurable
ir-:	regular, respective
il-:	legal
dis-:	order, advantage, to connect, to like, to charge, to appear
mis-:	use, understanding, firing
pre-:	heated, determined, set

**Упр. 12. Прочитайте и переведите текст. Найдите ключевые слова и выражения, которые передают основную мысль текста. Составьте аннотационный перевод.**

The Lexus SC 430 is a luxurious roadster that converts to a hard-top coupe with a the press of a button. It's smooth and quiet, powerful and enjoyable to drive. Its interior is beautiful, comfortable, and luxuries. It's a terrific two-seats car for a long drive for all practical purposes,

The Lexus SC 430 is enjoyable to drive. Its rear-wheel-drive is the proper layout for a performance car; it is not intended to be driven like a race car. It is, after all, a Lexus, designed to excel in the areas of comfort and refinement.

The SC 430 is quick, but not lightning quick. It's capable of accelerating from 0-60 mph in 5.9 seconds, according to Lexus. The double overhead-cam 4.3-liter all-aluminum V8 produces 300 horsepower at 5600 rpm and 325 pounds-feet of torque at 3400 rpm. The

SC 430 offers acceleration performance comparable to that of the Mercedes SL 500 and Jaguar XK8. Top speed of the SC 430 is about 156 mph more than fast enough. When driving around town the Lexus is smooth, quiet and sophisticated. It's a very flexible engine, with strong torque at low rpm, so it's always ready to show its power when **you are pressing the accelerator and it's never struggling to deliver smooth power.**

The five-speed automatic transmission shifts smoothly. It features three shift modes (Normal, Sport, Winter). Mounted on the floor console, the shifter has a C-shaped gate, allowing semi-manual shifting. The Lexus transmission is designed to be smooth, not quick, however, so it does not respond as quickly as a Mercedes or Porsche transmission, even in Sport mode.

The SC 430 features the latest in active safety system that will do everything physically possible to keep the car headed in the direction the driver is steering : anti-lock brakes (ABS), electronic brake-force distribution (EBD), traction control. Vehicle Skid Control (VSC) and Brake Assist. This is great technology to have as it can help you to avoid an accident. While it's good to have at least a proper understanding of what these systems do, it's less important to understand how they work. The important thing to know is that when faced with having to suddenly take a maneuver, you should press down firmly on the brakes, remember to look and steer in the direction you want to go, all the while maintaining hard pressure on the brake pedal.

ABS prevents the brakes from locking up so that the driver maintains steering control. Electronic brake-force distributions (EBD) maintains the proper balance of breaking force to all four tires. Brake Assist (BA) help maintain hard pressure on the brake pedal when the system detects the driver is making the mistake of relaxing pressure on the brake pedal. Vehicle Skid Control (VSC) reduces skidding in a corner by correcting for oversteer or understeer. Traction control reduces rear wheel spin when accelerating on slippery surfaces. If that doesn't save you the SC 430 has excellent seat belts with pretensioners so be sure and use them. It has side-impact airbags in addition to the dual frontal airbags. The 18-inch alloy wheels are fitted with P245/40z R18 Dunlop summer tires. The Lexus SC 430 is very smooth and very pleasant and costs much less than other cars in this class.

**Упр. 13. Выполните письменный перевод следующего текста.**

Controlling the exhaust gas behavior in low consumption lean mode is a great challenge for direct fuel injection. The resulting nitrogen oxide emissions are lower as they leave the engine than with conventional gasoline engines and are lowered further through high exhaust gas recirculation rates: however, they cannot be reduced by the familiar three-way catalytic converter. The new NOx storage catalytic converter required for compliance with the strict exhaust emission laws must be regenerated every minute. To do this, the mode is briefly switched from 'lean stratified' to 'normal homogeneous'. The most difficult task here relates to the engine management system which has to switch back and forth between the two modes instantaneously and unnoticed by the driver. The Motronic MED 7 engine management system - the first series concept of this type - specially developed by Bosch for direct injection gasoline engines is intended for these management tasks. Its task is to control the fuel quantity, throttle valve and ignition angle in such a way that the engine torque remains constant during the switchover. In conjunction with the electronic EGAS throttle valve controller, the MED 7 system represents the decisive basis for the introduction of BDE into series-type production.

**Упр. 14. Составьте аннотацию текста, рассказывающего об основных технических и эксплуатационных характеристиках Lexus SC 430, используя следующие выражения:**

The text deals with... . Attention is drawn to the fact that... . It is pointed out that... . It should be noted that... .

Unit 11

VW New Beetle 1.8

**Упр. 1. Запомните новые слова и выражения и их значения.**

1. adapt (v) – регулировать, приспособливать
2. adjust(v) – регулировать
3. bump – столкновение, удар
4. damping characteristics – амортизирующие характеристики



5. dashboard – приборная доска
6. disc brakes – дисковые тормоза
7. distinguish (v) – отличать, различать
8. fender – крыло автомобиля
9. flat cornering – небольшой крен на поворотах
10. folding key - складной ключ, (чип)
11. fuel consumption – потребление топлива
12. grip – сцепление
13. intrusion – внедрение, вмешательство
14. pads - колодки
15. pollen filters – фильтры тонкой очистки
16. pop-up – приподнятый, выдвижной
17. power windows with front one-touch down feature – электростекло-подъемники
18. rain sensing windshield wipers – стеклоочистители, реагирующие на дождь
19. rear – задний
20. remote control – пульт дистанционного управления
21. self-dimming – самозатемняющееся
22. shift knob – кнопка переключения
23. spoiler – спойлер, закрылка
24. suspension – подвеска
25. tilt telescoping steering wheel – серворуль (рулевое колесо на телескопической колонке с переменным углом наклона)
26. traction control – контроль тягового усилия
27. transferable power train warranty – гарантия, допускающая замену силового агрегата
28. torque – крутящий момент
29. washer nozzles (windshield) – форсунки стеклоомывателя

**Упр. 2. Прочтите и переведите интернациональные слова.**

Standard, lamp, bumper, virtual, tachometer, model, sport, litre, comfort, automatic transmission, season, disc, control, regulate, plastic, cruise control, simulate, principle, hydraulic, project, distance.

**Упр. 3. Переведите предложения на русский язык обращая, внимание на новые слова.**

1. The new model has some standard features such as light alloy wheels, front fog lamps, perforated leather seats . 2. The New Beetle 1.8T's suspension is similar to the Golf. 3. A safety feature on the new Beetle 1.8T is EDL low speed traction control. 4. Standard equipment on the GLS model includes front fog lamps, pop-up rear spoiler and full-size spare tire. 5. The New Beetle has 2year/40,000km warranty. 6. New Beetle is very comfortable on the highway and it's fun to drive around town. 7. The optional 4-speed automatic transmission can be adapted to the driver's style and it changes with gentle bump. 8. The EDL(electronic differential lock) and ABS(anti-lock brakes) automatically prevent front driving wheels from spinning in slippery conditions.

**Упр. 4. Переведите выделенные слова на английский язык, используя активную лексику урока.**

1. The New Beetle's turbocharged 1.8 litre engine's (потребление топлива) is 10.7 l/100 km (22 mpg) in the city. 2. The New Beetle exhibits very (небольшой крен на поворотах), excellent (амортизирующие характеристики) and a high level of (сцепление). 3. It also has speed-sensitive wipers, cruise control, (складной ключ) with remote control, (фильтры тонкой очистки) and rear-reading lights. 4. The 1.8T GLX adds (стеклоочистители, реагирующие на дождь), heated washer (форсунки стеклоомывателя) and (самозатемняющееся) rearview mirror. 5. Standard equipment of new Beetle includes five speed manual transmission, four wheel (дисковые тормоза), plastic (передние и задние крылья). 6. The ASR (anti-slip regulation) high-speed (контроль тягового усилия сцепления) can be turned on and off with the button on the (приборная доска). 7. The warranty for (тормозные колодки) is for the first 12 months.

**Упр. 5. Выберите правильное определение для каждого данного слова и переведите их на русский язык.**

bumper, tachometer, speedometer, traction, alloy, highway, grip.

1. a metal that consists of two or more metals mixed together.
2. a wide main road that joins one town to another.

3. a bar fixed on the front and back of a car to protect it if it hits anything.
4. power and control over something or someone.
5. the force that prevents something such as a wheel sliding on a surface.
6. a piece of equipment used to measure the speed at which the engine of a vehicle turns.
7. instrument in a vehicle that shows how fast it is going.

**Упр. 6. Выберите правильный перевод словосочетаний, где слово "DRIVE" является определяющим.**

- |                              |   |
|------------------------------|---|
| 1) twin-camshaft chain drive | a) шестеренный привод клапанного механизма  |
| 2) camshaft drive            | b) цепной привод с двумя распредвалами      |
| 3) camshaft gear drive       | c) привод от двигателя                      |
| 4) rear-axle gear drive      | d) привод счетчика пробега                  |
| 5) pneumatic drive           | e) поршневой привод                         |
| 6) engine drive              | f) привод с тремя ведущими мостами          |
| 7) valve-gear drive          | g) шестеренный привод распредвала           |
| 8) odometer drive            | h) привод распредвала                       |
| 9) multiple strand drive     | i) пневматический привод                    |
| 10) piston drive             | j) шестеренная передача                     |
| 11) tri-axle drive           | k) передача с несколькими клиновыми ремнями |

**Упр. 7. Переведите предложения на русский язык, обращая внимание на перевод глаголов с предлогами, стоящими после них.**

1. This accounts for the fact that the world at large uses a great number of automobiles. 2. Charles Rolls was an aristocrat and businessman and he was especially interested in cars. 3. Stabilization can be carried out by adding substances that harden the soil, and greatly increase its comprehensive strength. 4. In the 1960s, vehicles were equipped with oil pressure, fuel level and temperature coolant sen-

sors. 5. The dynamometers can cope with front-, rear-, and four-wheel drive configurations. 6. The first electrical cars were built at the end of the 19<sup>th</sup> century, but they couldn't compete against the internal combustion engine. 7. The valve train consists of the valves and a mechanism that opens and closes them.

**Упр. 8. Переведите предложения на русский язык, обращая внимание на перевод причастия.**

1. Staying true to its Scandinavian design heritage the 9-3 Saab is a pragmatic and functional car. 2. The new 2-litre petrol engine, developed at the company's plant in Sweden is 15 kg lighter than its predecessor. 3. Coupled with the new styling features is an abundance of chrome, including a chrome-plated side grille, fuel cap and twin tailpipes in the middle of the rear bumper. 4. Honda predicts that diesel sales will contribute to grow, especially with tax incentives and benefits being offered on alternatives to petrol. 5. The car was designed with the needs of young families leading an active way of life in mind. 6. Until now, Jaguar station wagons were relatively rare, appearing only as the result of modifications performed by British companies such as Lynx. 7. The car automatically adjusts the clearance, lowering the vehicle at high speeds and raising it the vehicle at for city driving. 8. Increasing road traffic intensifies the demands being made on drivers.

**Упр. 9. Переведите предложения на русский язык, обращая внимание на перевод инфинитивного оборота "сложное дополнение".**

1. I observed the 1.8T to have some standard features, typical for Volkswagen. 2. For its size, I found the 1.8 liter engine to develop a lot of power and a lot of torque. 3. I expected my test car to have the optional 4-speed automatic transmission with adaptive shift points that adapt to the driver's style. 4. I noted the New Beetle to exhibit excellent driving performance. 5. I assumed these automatically to prevent the front driving wheels from spinning in slippery conditions. 6. I also found standard equipment on the GLS model to include the turbocharged 1.8 litre four cylinder engine. 7. I consider a 5 year/80,000 km transferable powertrain warranty to be also standard.

**Упр. 10.Образуйте новые части речи и переведите их на русский язык.**

re-:	to use, to take, to name, to charge, to create, to group, to equip, to move, to place, to generate
super-:	low, critical, to cool, man, car, to heat, conductive, cool
sub-:	to divide, division, station, way, group, normal, system
en-:	able, circle, large, close, force, rich
over-:	to estimate, to charge, to heat, to cool, to load, to pay, to value, to take
inter-:	to charge, to mix, to act, change, connection, dependence, communication, cooler
under-:	to charge, to value, to estimate

**Упр. 11. Прочитайте и переведите текст. Дополните свой терминологический словарь.**

If you were hoping to impress your friends with the 150 horsepower New Beetle 1.8T, you might be disappointed. The 1.8T is virtually indistinguishable from the standard New Beetle model with the 115 horsepower 2.0 liter four cylinder engine. I observed the 1.8T to have some standard features, such as alloy wheels, front fog lamps, perforated leather seats and a sport steering wheel.

For its size, I found the 1.8 liter engine to develop a lot of horsepower, and more importantly, a lot of torque. On the highway the engine turns over a comfortable 2800 rpm at a steady 100 km/h, a bit higher than average.

The New Beetle's turbocharged 1.8 litre engine's fuel consumption is 10.7 l/100 km in the city and 7.8 l/100 km on the highway. It uses Premium grade gasoline.

I expected my test car to have the optional 4-speed automatic transmission with adaptive shift points that adapt to the driver's style, whether it's gentle or aggressive. This transmission changes with a gentle bump. The New Beetle 1.8T's suspension is similar to the Golf. I noted the New Beetle to exhibit very flat cornering, ex-

cellent damping characteristics, a comfortable ride, and a high level of grip 205/55R-16 all-season tires are standard on 1.8T models.

Like all New Beetles, the Beetle 1.8T has standard four wheel disc brakes with ABS (anti-lock brakes). I was impressed with the power of these brakes and the added safety of standard ABS. A safety feature offered on the New Beetle 1.8T is EDL (electronic differential lock), low-speed traction control, and ASR (anti-slip regulation) high-speed traction control. I assumed these automatically to prevent the front driving wheels from spinning in slippery conditions. For those who don't want this computerized intrusion into their driving style, the ASR can be turned on and off with a button on the dashboard.

Overall, I found the New Beetle 1.8T fun to drive around town and very comfortable on the highway. The extra power of the turbocharged engine helps when changing lanes, accelerating onto the freeway, and passing slower automobiles, and it makes the whole driving experience more enjoyable.

I also found standard equipment on the GLS model to include the turbocharged 1.8 litre four cylinder engine and five-speed manual transmission, four wheel disc brakes with ABS, power steering, ASR and EDL, body coloured bumpers, plastic front and rear fenders, tinted green glass, front fog lamps, power heated mirrors, pop-up rear spoiler, full-size spare tires and 205/55R-16 inch tires with steel wheels and wheel covers.

Also standard on the GLS are power windows with front one-touch down feature, speed-sensitive wipers, air conditioning, alarm and immobilizer, cruise control, tachometer, folding key with remote control, central door locking, height-adjustable front seats, tilt/telescoping steering wheel, pollen filters, and rear reading lights.

The 1.8T GLX adds the leather seats, Monsoon sound system, sunroof, heated front seats, leather-wrapped steering wheel and shift knob, rain-sensing windshield wipers, heated windshield washer nozzles, and self-dimming rearview mirror.

The New Beetle 1.8T has Volkswagen's 2 year/40,000 km warranty - wear and tear items like brake pads are included for the first 12 months. I consider a 5 year/80,000 km transferable powertrain warranty to be also standard.

**Упр. 12. Выполните письменный перевод следующего текста.**

With the DISRTRONIC distance monitoring system, proximity to the vehicle in front can be kept to the limit without the driver right to decide. In practice, driving with the DISTRONIC system is like having **one's own car linked to the vehicle in front by a virtual towbar**. And since it is coupled with the TEMPOMAT cruise control function, hardly anything new needs to be learned: By means of the small lever on the steering column, the driver sets the desired speed initially in steps 10 km/h (about 6 mph) and with fine adjustments of 1 km/h, and if no one else is on the road, the car nicely maintains this speed thanks to the braking action.

Whenever the driver initiates braking, DISTRONIC is deactivated automatically, as there is also the case when the Electronic Stability Program(ESP) intervenes to avoid skidding. A little movement of the hand-operated lever reactivates the functions. But the distances alert can also be used without automatically triggering brake activation. The distance to the vehicle in front is still measured and shown on a scale in display; however, should the gap narrow to the hazardous degree, the system contents itself with issuing a visual warning and a double audible tone.

**Упр. 13. Составьте письменный реферат об основных технических характеристиках автомобиля New Beetle 1.8T, используя следующие выражения:**

The text deals with ... . The text gives a valuable information on ... . Attention is drawn to the fact that ... . ...are discussed. Underlined is the conclusion that ... .

Unit 12

Transport for Tomorrow

**Упр. 1. Запомните новые слова и их значение.**

1. adjust (v)– регулировать
2. angle - угол
3. apply (v)– применять
4. avoid (v)- избегать

5. axis - ось
6. brakes – тормоза
7. buzzer – звуковой сигнал
8. current (adj)– современный, текущий
9. destination – пункт назначения
10. detect (v)- обнаруживать
11. directly - прямо
12. ensure (v)- обеспечивать, гарантировать
13. equip (v)- оборудовать
14. exceed (v)- превышать
15. exhaust - выхлоп
16. guidance – управление, наведение
17. ignition - зажигание
18. indicate(v)указывать, показывать
19. mount (v)- монтировать, устанавливать
20. sophisticated - сложный
21. withstand (v)- выдерживать

**Упр. 2. Прочтите и переведите интернациональные слова.**

Public, transport, efficient, office, problem, to plan, modern, electric, person, automatic, system, telephone, address, decade, automobile, radio, electronics, corporation, computer, monitor, carburetor, economy, instrument, panel, microelectronics, to control, radar, design, bumper, object, stationary.

**Упр. 3. Переведите предложения на русский язык обращая, внимание на новые слова.**

1. With an automatic guidance system for cars being developed, it will be possible for us to select our destination. 2. At present sophisticated electronics is playing a big part in current automotive research. 3. In every gasoline-powered car there is a small computer continuously monitoring the exhaust. 4. The device adjusts the vehicle carburetor fuel intake to get the best fuel economy. 5. Radar may control the brakes to **avoid collisions and a display screen may show the car's position on the road.** 6. The radar aerial looks like a third headlight placed directly above the bumper. 7. The red light and buzzer on the instrument panel warn that the speed should go down. 8. Another red light and sound signal



make the driver apply the brakes. 9. The car's four-wheel control system ensures movement diagonally and even sideways at right angles to the longitudinal axis.

**Упр. 4. Выберите правильное определение для каждого данного слова и переведите их на русский язык.**

radar, lane, monitor, collision, transport, navigation, traffic, destination, journey.

1. a system or method for carrying passengers or goods from one place to another.
2. a place that someone or something is going to.
3. one of the two or three parallel areas on a road which are divided by painted lines to keep traffic apart.
4. a time spent traveling from one place to another, especially over a long distance.
5. a piece of equipment that uses radio waves to find the position on things and watch their movement.
6. an accident in which two or more people or vehicles hit each other while moving in different directions
7. the science or job of planning which way you need to go when you are traveling from one place to another.
8. a television or part of a computer with a screen, on which you can see pictures or information.
9. (movement) of people and vehicles along roads and streets, of aircraft in the sky.

**Упр. 5. Переведите предложения на русский язык, обращая внимание на употребление многофункционального слова "for".**

1. Careful design of body panels and joins is the best starting point for corrosion prevention. 2. For corrosion resistance the following items should be considered by the designer. 3. Sensor manufacturers are searching for better ways to design and manufacture of sensors. 4. When a car turns a corner, it is necessary for the outside wheel to revolve faster, because it has a longer distance to travel than the inside wheel. 5. To insure maximum safety for the transportation system, it is necessary to plan and design highways on sound engineering techniques. 6. For this

reason the automobile is provided with four or five changes of gears. 7. Motorists had to carry large cans of fuel and separate spare parts, for there were no repair or filling stations to serve them.

**Упр. 6. Переведите предложения на русский язык, обращая внимание на перевод сложных предлогов.**

1. The word "clutch", as used in connection with automobiles, indicates a device attached to cars having changed speed gears of the sliding type. 2. Modern roads should be designed according to the anticipated volume and speed of the traffic. 3. The night vision system uses a unique camera that, due to its small dimensions, can be placed so close to the driver's head that it duplicates his/her view as closely as possible. 4. In spite of the car having the larger engine, the price of new model has remained unchanged. 5. The differential is automatic mechanism which operates according to the resistance of the road against the revolving wheels.

**Упр. 7. Переведите предложения на русский язык, обращая внимание на перевод причастий.**

1. Having designed a car radar the engineers started complex tests. 2. While driving a car one should be very attentive. 3. A new electronic instrument calculates how far one can drive on the fuel left in the tank. 4. The engine tested showed that it needed no further improvement. 5. Scientists are experimenting with a system allowing drivers to see better after dark. 6. The system being tested will increase the safety and fuel efficiency of a car. 7. The night vision system designed was available in the 1990's. 8. Recently there appeared battery-powered cars. 9. The radar used was of a completely new design. 10. Being provided with batteries an electric car can develop a speed of 50 miles an hour. 11. When mass produced, electric cars will help solve ecological problems of big cities. 12. A defect undetected caused an accident. 13. Though first developed for military purposes radar can be used in modern cars.

**Упр. 8. Переведите предложения, содержащие независимый причастный оборот.**

1. Today's vehicles are composed of many systems, each affecting customer satisfaction and environmental impact. 2. The steam engine having been invented in 1825, a self-propelled vehicle was built. 3. The German N. Otto

having invented the gasoline engine, the application of this engine in motor cars began in many countries. 4. The cars at that time were very small, the engine being placed under the seat. 5. Brakes having become more efficient, cars achieved greater reliability. 6. Cars with internal combustion engines having appeared, the automobile industry began developing rapidly. 7. By 1960 the number of cars in the world had reached 60 million, no other industry having ever developed so quickly.

**Упр. 9. Переведите предложения на русский язык, обращая внимание на перевод инфинитивного оборота “сложное дополнение”.**

1. This enables a large number of features to be incorporated including automatic air conditioning with a day/night function. 2. The system allows the driver to access various layers of functionality via easy-to-use menu. 3. Clutch is a device which permits the engine to be connected with, or disconnected from, the transmission mechanism. 4. A unique rear suspension and lowered floor allow for the batteries and electronics to be packaged behind the rear seat. 5. We suppose these new kinds of alloys to be used for the production of bearings and gears.

**Упр. 10. Заполните таблицу, образуя указанные части речи.**

VERB	NOUN	PERSON	ADJECTIVE
compete	....	....	....
...	action	....	....
....	...	transporter	....
....	....	....	productive
assemble	....	....	-----
....	manufacture	....	-----
found	....	....	-----
...	drive	....	....
...	....	----	reducible
...	....	....	indicative

**Упр. 11. Переведите цепочки однокоренных слов.**

1. restrain – restrained – restraining – restrains
2. absorb – absorbent – absorber – absorbing absorption
3. visibility – visible – visibly – vision – visual
4. enhance – enhancement – enhancing – enhanced
5. apply – application – applicable – applied – applied – appliance – applicant
6. rely – reliable – reliability – reliance
7. evolve – evolution – evolved – evolving
8. link – linkage – linked – linking

**Упр. 12. Прочитайте текст. Поделите текст на смысловые части и переведите ту часть, которая наиболее точно выражает основную идею текста.**

One thing is certain about the public transport of the future: it must be more efficient than it is today. The time is coming when it will be quicker to fly across the Atlantic to New York than to travel from home to office. The two main problems are: what vehicle shall we use and how can we plan our use of it?

There is already a number of modern vehicles which are not yet in common use, but which may become a usual means of transport in the future. One of these is the small electric car: we go out into the street, find an empty car, get into it, drive to our destination, get out and leave the car for the next person who comes along. In fact, there may be no need to drive these cars. With an automatic guidance system for cars being developed, it will be possible for us to select our destination just as today we select a telephone number, and our car will move automatically to the address we want.

For long journeys in private cars one can also use an automatic guidance system. Arriving at the motorway, a driver will select the lane he wishes to use, switch over to automatic driving, and then relax - dream read the newspaper, have a meal, flirt with his passenger - while the car does the work for him. Unbelievable? It is already possible. Just as in many ships and aircraft today we are piloted automatically for the greater part of the journey so in the future we can also have this luxury in our own cars.

Some decades ago, the only thing electronic on most automobiles was the radio. But at present sophisticated electronics is playing a big

part in current automotive research. For example, in every gasoline-powered car that General Motors Corporation makes there is a small computer continuously monitoring the exhaust. The device, about the size of a pack of cigarettes, adjusts the vehicle carburetor fuel intake to get the best fuel economy. Ford cars are equipped with an electronic instrument panel that, among other things, calculates how far one can drive on the fuel left in the tank. It also estimates the time of arrival at destination and tells the driver what speed he has averaged since turning on the ignition.

According to specialists these features made possible by microelectronics are only the beginning. Radar may control the brakes to avoid collisions, and a display screen may show the car's position on the road. Recently a radar to be mounted on lorries and cars has been designed in the USA. The radar aerial looks like a third headlight placed directly above the bumper. Having summed up the information about the speed and distance of various objects ahead, the computer detects all possible dangers and their nature. A third component in the system is a monitor on the instrument panel. The radar only observes objects ahead of the vehicle. It is automatically turned on when the speed exceeds ten miles an hour. The green light on the panel indicates that the system is on. The yellow light warns of stationary objects ahead, or something moving slower than the car. The red light and buzzer warn that the speed should go down. Another red light and sound signal make the driver apply the brakes.

A Japanese company designed a car of a new generation which started running on the roads in the 90s. When completed, the new model has a lot of unusual characteristics. The car's four-wheel control system ensures movement diagonally and even sideways, like a crab, at right angles to the longitudinal axis. This is especially important when leaving the car in parking places. To help the driver get information while concentrating on the road the most important data is projected on the wind screen. A tourist traveling in such a car does not lose his way even in Sahara with its impossible roads: a navigation Earth satellite indicates the route.

**Упр. 13. Выполните письменный перевод следующего текста.**

A new vacuum-controlled constant velocity carburetor developed by an American company offers several advantages over ordinary

carburetors, including 25 percent gasoline economy, improved engine performance and easier starting. The device having only 54 parts compared with some 300 in conventional carburetors has no choke (дроссель). It constantly adjusts the mixture of fuel and air, which cannot be done in usual carburetors. Provided with special mechanism the carburetor helps the engine turn on at once in cold weather. Though developed quite recently it is already being used by cars and other kinds of public transport. With diesel engine becoming almost standard equipment, the vacuum carburetor will never be used on new cars. It may be said that present-day carburetors are a dinosaur and in **20 years they won't be any more. But there are some countries which** are interested in importing the device as a replacement for existing carburetors.

**Упр. 14. Составьте письменный реферат текста “Transport for tomorrow”, используя следующие выражения:**

The text is devoted to ... ... are discussed. It is spoken in detail ... Much attention is given to ... The author comes to the conclusion that ...

## ДОПОЛНИТЕЛЬНЫЕ ТЕКСТЫ ДЛЯ ПЕРЕВОДА

### Extending the Benefits of ESC

In 2005, the automotive industry celebrated 10 years of manufacturing a technology that proved invaluable for increasing passenger vehicle safety. Electronic stability control (ESC) first came to market on the 1995 Mercedes-Benz S-Class. Since being introduced, ESC has received numerous accolades for its ability to reduce vehicle crashes by decreasing skidding and improving vehicle stability. Most recently, the National Highway Traffic Safety Administration (NHTSA) confirmed ESC's significant role in passenger safety, indicating that the technology reduced fatal SUV crashes by 67%, and fatal car crashes by 35%.

An important aspect of ESC is its ability to work in conjunction with other safety applications. Rollover mitigation (ROM) is one example of this flexibility at work. Through existing ESC sensors, ROM can help reduce rollover risk by determining when a vehicle is experiencing extreme lateral tire forces, and activate to reduce those forces. Additionally, trailer sway mitigation uses existing ESC system components to prevent unstable oscillations and trailer sway through brake interventions on the tow vehicle.

Looking further into the future, it is evident that ESC will serve as a gateway for other important safety systems. The range of data ESC provides can significantly influence the performance of technologies such as adaptive cruise control (ACC), airbags, collision mitigation, and automatic emergency brake systems. For example, while ACC can theoretically function without ESC, when ESC data is provided, the performance and benefits of ACC are expanded for the driver. Specifically, ESC provides an increased deceleration capability through active braking without sacrificing vehicle stability. Additionally, in the event of an emergency braking situation, ESC allows the vehicle to maximize braking, which in the future will assist collision-mitigation technologies in avoiding an accident or at least minimizing the effects of a collision.

Likewise, as ESC helps to maximize braking scenarios, it can also interact with airbags to result in more effective deployments. ESC has the ability to act as an early indicator, communicating to the airbags

that a vehicle is in an unstable condition (such as sliding sideways). By pre-arming the airbags with more comprehensive data, the airbags are then able to deploy more quickly and accurately.

Not only does performance improve when controllers from one system are able to communicate with controllers of another system, but this interaction also provides a way to reduce costs for automakers; further reason for the industry to become involved in initiatives such as Automotive Open System Architecture. Defining a worldwide industry standard for basic functions and interfaces in every automotive electronic control unit is a necessity to ensure the effective application of these future, system-to-system interfaces. This common standard is also the only way the industry is truly making the shift from thinking about vehicle safety in terms of crash worthiness to thinking about it from the perspective of crash avoidance, which ultimately saves more lives. And ESC is a key starting point for this growth in system-to-system interface.

### **BMW's Drivetrain For Tomorrow**

One of BMW's core competencies is the development of combustion engines. During recent years BMW has significantly reduced both fuel consumption and emissions in its engines, while simultaneously increasing performance and torque. The latest milestones from these efforts are the first-ever variable twin-turbocharger diesel power unit in a road vehicle, making its debut in the new BMW 535d, and the new BMW six-cylinder gasoline engine with 12% increased power and 12% less consumption. In the future, the introduction of spray-guided direct injection and the implementation of "lean combustion" will bring consumption in the gasoline engine closer to the values attained by modern diesel units.

An important component in developing drive technology lies in intelligent electric power for the drivetrain, for example through an "active gear" combined with high-performance capacitors. The function of an intelligently honed drive is to intervene electrically in the drivetrain and optimize driving situations like stop-and-go traffic or acceleration. However, all concepts geared towards intelligent electrification remain no more than an auxiliary solution for the internal combustion engine.



As shown in the BMW X5 experimental vehicle, an electric motor between the internal combustion engine and the gearbox supports the conventional drive during acceleration efficiently. The research vehicle was presented in 2003 and produced responses that had never been attained before, while also increasing torque to 1000 N-m (740 lb-ft) in the lower range. More important, the vehicle also reduced fuel consumption by up to 15% in the driving cycle compared to the conventional powertrain.

Over the long term, hydrogen is thought to be the fuel with the greatest potential for sustainable mobility in the future. BMW Group specialists are permanently working on improvements of the hydrogen combustion engine. Already, by setting nine records and reaching a top speed of 302.4 km/h (185.5 mph) with the BMW H2R research vehicle on September 19, 2004, the BMW Group has clearly proven its conviction that hydrogen is able to replace conventional fuel without requiring the driver to make compromises in terms of up-to-date dynamic performance.

The reliability and durability of the technology used clearly demonstrates the capability of BMW Group in developing the hydrogen engine to production standard. In this process, BMW is concentrating on the combustion engine simply because the combustion power unit, given the sum total of all its features and characteristics, still offers the largest number of advantages and benefits all in one.

BMW's future hydrogen engine for its premium saloon will be built for dual-mode operation. BMW will be launching a dual-mode version of the 7Series during the production cycle of the present model, thus introducing the first car of its kind able to run on both hydrogen and gasoline.

### The Diesel Solution

The future of commercial vehicles is a subject that we at Navistar International focus on every day. In fact, it's our core business, as we are the nation's largest combined commercial truck, school bus, and mid-range diesel engine producer.

Today, I'm more convinced than ever that focusing on diesel was a smart decision, and that the leading engine technology for the foreseeable future, indeed for the 21st century, will be diesel.

We listen to our customers, and they tell us what they need. The companies who listen better tend to do better. The reason we chose diesel over gasoline was that our customers believed in diesel and understood its advantages, including:

- **A longer driving range without refueling**
- **40 to 60% better mileage than gasoline, due to greater fuel efficiency**
- **Durability, since diesel engines typically last at least twice as long as gasoline engines**
- **Performance, with torque that is 30 to 50% higher than gasoline engines**
- **Increased safety, with reduced risk of flammability**
- **Extended idling capability, which is one reason virtually all ambulances are diesel.**

The challenge is the perception that diesel is "dirty," an image many people still have. But in fact, we aren't making smoky trucks **anymore, and haven't for many years. We introduced a smokeless engine in 1989, and haven't looked back since.**

The reality is that today's diesel has 98% lower emissions than it did before regulation, and we have led the way in demonstrating that diesel engines in trucks and school buses can be as clean or cleaner than engines powered by any other fuel. Our company's path to low-emitting diesel technology is called International Green Diesel Technology, which combines efficient, high-tech engines that use fuel even more efficiently (and actually start the emissions clean-up in the cylinder); advanced aftertreatment that captures and burns emissions before they escape; and ultra-low-sulfur (ULS) diesel fuel that lets the aftertreatment work, similar to the way that removing lead from gasoline enabled catalytic converters to work in passenger cars.

In fact, diesel has already proven to be the preferred solution for consumers, business, environmentalists, school districts, and the military. From school buses to ambulances to an increasing number of passenger vehicles, the vehicles that people depend on are diesel-powered.

Diesel is already the solution for virtually all heavy-duty trucks and almost all medium-duty trucks. Heavy-duty pickup owners are now switching to diesel. With the technology and new fuel widely available, this trend will include diesel in SUVs and light pickups. In

the U.S. and Canada, we are on the way to what they are doing in Europe, where roughly 50% of new cars are diesels.

Diesel offers the U.S. the opportunity to save on both fuel economy and emissions. As to fuel economy, the Department of Energy estimates that if light-duty diesel achieved only 30% of its market potential—not 50% as in Europe—by 2020, we'd save 700,000 barrels of oil a day, or one-half the daily energy use of California. By my rough estimate, that translates to over half a billion pounds of CO<sub>2</sub> a day—more than 200 billion pounds a year.

At the national policy level, diesel offers immediate advantages over any other power source. New low-emitting diesel vehicles (such as school buses) are just as clean, if not cleaner, than those using natural gas. Hydrogen fuel cells sound exciting, but are decades away. By contrast, within a short time frame, diesel offers our nation the following opportunities:

- **To reduce our cost per mile traveled**
- **To reduce our imports of foreign oil**
- **To reduce CO<sub>2</sub> emissions.**

When you consider all these advantages, it's clear that the public and national interest stands to benefit from America's strengthening its commitment to low-emitting diesel vehicles. Yet as matters currently stand, the highest costs of making this move will fall on the truck and bus customers who buy new products in 2007.

That is why I believe government needs to do everything possible to provide incentives to help commercial vehicles make the transition to low-emitting diesel. We need to help people in the trucking business today make their purchase commitments for 2007. And we need to accelerate the trend toward diesel, which is in the long-term national interest. I am confident that the marketplace will make the right decision—as it did after we placed our bet on diesel in the mid-1980s.

### From Speedometer to Modern Instrument Clusters

On October 7, 1902, engineer Otto Schulze received a patent for an eddy-current speedometer. Modern driver information has come a long way since then, encompassing a whole history of automobile instrumentation that would be unimaginable without Schulze's speedometer and its technological successors.

The first automobiles had no "cockpit" as such. And there was simply no need for instruments. Even in motor racing events staged in France around 1895, the maximum speed was roughly 30 km/h (18 mph).

Things started to change around the turn of the century when accidents became a problem. Among the first solutions were speedometers with a small dial for driver use and a much larger display that was legible from a distance so police could enforce speed limits. One of Hasler's (a Swiss manufacturer) systems included a large speedometer indirectly illuminated by an acetylene flame.

The year 1905 saw the first mass-produced speedometers. Temperature sensitivity allowed for 4.3% error for every 10 degrees on the dial. The eddy-current speedometer came of age as early as 1910, and it featured a temperature-compensation system.

VDO was born of the 1928 amalgamation of the Deuta and OTA. By then, instruments were starting to take on a new look. Very soon, alternatives to the familiar round dial-and-pointer design with a concentric or eccentric scale showed up. The speedometer advanced in a number of ways over the following years. Along the way, tachometers and audio systems were introduced, and the idea of instrument clusters grew popular.

The first all-LCD cluster instrument appeared as early as 1986. The first all-electronic speedometer appeared in 1993. The head-up display is a more recent innovation, as is the electro and navigation capability.

Present and future instruments must keep drivers informed about growing range of vehicle systems and parameters without subjecting information overload. The challenge is to design a leaner, simplified **human/machine interface (HMI) within the driver's visual field** that still manages to convey all of this information. Designers have responded by teaming the familiar round-dial instrument with multi-functional displays that make the best use of the limited surface area of the dashboard.

Improvements in instrument clarity and electronic support systems have certainly resulted in a better physical environment and reduced stress, but these same instruments have also created a new challenge: All of those driving aids now have to be started, properly monitored by the driver. Much more than ever before, the field of cluster in-

strument ergonomics must focus on driver selection capability as part of an overall control concept. The key requirement is for a **multifunctional display content to continuously match the driver's** input. Speech input is one suitable option, as is the rotary/pressure controller instrument with freely programmable touch feedback. Then there is the important question of which input methods individual drivers actually prefer, so multi-mode interfaces can be featured more prominently in the future.

There is no doubt that, measured against the challenges posed by current and future traffic management requirements, the speedometer from 100 years ago appears antiquated. But it is, and remains, the point of origin of the concept of driver information and the very beginning of traffic management initiatives. Drivers needed to know their speed, and that's where it all started.

### The Future of Vehicle Safety

Continental Automotive Systems is working aggressively on the developments in a project called the Total Safety Approach. Total Safety points the way to a vehicle that helps avoid accidents and prevent injuries, achieved by integrating environmental sensors to network active and passive vehicle safety systems. The goal is to incorporate active vehicle intervention technology to help prevent accidents from happening, and it represents a technology-driven shift in focus.

The shift of focus from passive to active vehicle safety has already moved beyond the safety community and into regulatory agencies such as the National Highway Traffic Safety Administration (NHTSA). NHTSA has recently taken steps in researching and testing active-safety technologies.

The best way to reduce injuries and fatalities is to avoid a crash in the first place, and great advances in microelectronics capability and functionality are making this possible. Continental has developed a portfolio of active-safety technologies designed to make individual mobility safer, preventing many rollovers and crashes from occurring. Advanced systems such as lane-departure warning, distance control, and pre-crash sensors can identify a potentially hazardous situation and help keep the vehicle on course, on the road, and in control.

The foundation of these active safety technologies is Electronic Stability Control (ESC), a system that can detect unstable driving situations and make an automatic correction to protect the driver from losing control. ESC has been a significant milestone in vehicle safety advancements, on par with seatbelts and airbags. ESC compares the driver's intended course with the vehicle's actual movement using a complex system of sensors that measure wheel speed, steering-wheel angle, yaw rate, and lateral acceleration. If these sensors detect the driver is losing control, ESC uses a combination of ABS, electronic brake force distribution, traction control, and active yaw control to stabilize the vehicle and help keep it on the road.

Continental is already working to take ESC and active safety to the next level with ESC11, its next-generation system. Sometimes referred to as "steer-by-wire" ESC11 monitors active steering control functions and is the next step along the technology integration path that is leading the industry to new dimensions in driving dynamics and stability.

Continental's Total Safety concept integrates active-safety with passive-safety technologies—such as seatbelts and air-bags—for a unified approach to vehicle safety. Networking these technologies into a single system allows them to work in tandem and provide the most efficient crash-avoidance options. At the same time, comprehensive protection afforded vehicle occupants is maximized.

With Total Safety, active and passive systems are linked with environmental sensors through a Safety Control Module that monitors the driving environment for hazardous situations or potential vehicle collisions, and triggers the safety systems based on need.

The Total Safety system gauges dangerous situations and implements appropriate safety precautions much faster than a driver can. The system does not use crash-prevention systems to replace crash-protection systems, but rather complements their effectiveness by lessening the chance they will be needed. Said another way, the foundation of the approach taken by Continental safety systems engineers is that the best crash protection system is one that is never used. This approach contrasts with the traditional one in which safety efforts were focused mainly on crash protection.

Functionally, the active-passive integration transitions smoothly and happens transparently to vehicle occupants. When the system de-

etects a dangerous situation approaching, it warns the driver and then proactively takes action. If a collision cannot be avoided, occupants are automatically prepared. For example, if the vehicle is fast approaching another vehicle from behind:

- **The system informs the driver of impending danger through force feedback in the accelerator pedal and a visual warning**

- **All windows and the sunroof** are then automatically closed and the braking system is pre-filled in anticipation of maximum braking

- **The seatbelts are tightened to reduce slack and the seatbelt tensioners** are activated to hold vehicle occupants in their seats

- **Power seats automatically** adjust to an optimal safety position

- **The brakes begin to automatically apply by the time the driver** applies heavy pressure

- **The ABS system activates and ESC applies if necessary.**

The Total Safety concept car provides a glimpse into the future of automotive safety, and how much more advanced these individual systems can be for a voiding accidents and protecting vehicle occupants when they are integrated into one system.

The future of automotive safety is more than just developing new technology; it is shifting the approach to safety. By looking at safety in terms of avoiding accidents in the first place—and then protecting occupants when a crash is unavoidable—we can prevent more accidents, save more lives, and reduce insurance and medical costs to society. Continental's Total Safety approach represents a significant shift from the traditional approach to safety, but it is fundamental to achieving the substantial benefits.

### Реферативный перевод

Реферативный перевод является сокращенным вариантом полного письменного перевода. Реферат - это краткое изложение сущности какого-либо вопроса. Однако способы краткого изложения сущности вопроса могут быть разными.

Реферативный перевод - это полный письменный перевод заранее отобранных частей оригинала, составляющих связный текст.

Как правило, реферативный перевод должен быть значительно короче оригинала (в 5-10 раз), так как в процессе работы над реферативным переводом требуется вывод всей избыточной информации, количество которой, прежде всего, зависит от характера оригинала.

Работа над реферативным переводом состоит из следующих этапов:

1. Предварительное знакомство с оригиналом, ознакомление с данной областью знаний и ее терминологией, внимательное чтение всего текста.

2. Разметка текста с помощью квадратных скобок для исключения его второстепенных частей и повторений (исключаемые части текста берутся в скобки).

3. Чтение оригинала без исключенных частей в скобках.

4. Полный письменный перевод части оригинала, которая должна представлять собой связный текст.

Если в оригинале имеются чертежи, рисунки, то необходимо выбрать наиболее важные и объяснить их в переводе.

### Аннотационный перевод

Аннотационный перевод - это вид технического перевода, заключающийся в составлении аннотации оригинала на другом языке.

Аннотация - это короткая, сжатая характеристика содержания и перечень основных вопросов книги, статьи, рукописи.

Для того чтобы сделать аннотационный перевод, необходимо прочитать книгу или статью, составить план, затем сформулировать основные положения, перечислить основные вопросы. Стиль аннотационного перевода книги или статьи отличается свободным переводом, т. е. дается главная характеристика оригинала.



Аннотация специальной статьи или книги - это краткая характеристика оригинала, излагающая его содержание в виде перечня основных вопросов и иногда дающая критическую оценку.

Из этого определения вытекает, что такая аннотация должна дать читателю представление о характере оригинала (научная статья, техническое описание и т. д.), о его строении (какие вопросы и в какой последовательности рассматриваются). При составлении аннотаций на печатные работы необходимо придерживаться определенных требований:

1. Аннотации должны быть составлены так, чтобы их содержание было доступно для усвоения при первом же прочтении, в то же время должны быть отражены все наиболее важные моменты первоисточника.

2. Аннотации должны быть научно грамотны, они не должны отражать субъективных взглядов автора.

3. Язык аннотации должен быть лаконичным, точным и в то же время простым, лишенным сложных синтаксических построений.

4. В текст аннотаций часто вводятся неопределенно-личные местоимения и страдательнo-возвратные конструкции типа: «сообщается», «описывается», «излагаются» и т. д.

5. Употребление терминологии, сокращений, условных обозначений в аннотациях должно соответствовать нормам, принятым в конкретной области знаний.

При составлении аннотаций необходимо также учитывать следующее:

- в силу незначительного объема аннотация должна раскрывать, а не повторять иными словами заголовок источника информации;
- вид и объем аннотации зависят от значимости аннотируемого материала и его особенностей, а также от целевого назначения аннотации.

Для структуры описательной аннотации характерны следующие составные части:

1. Вводная часть, включающая название работы (оригинала) на русском языке, фамилию и имя автора, и название статьи на языке оригинала, название журнала или книги, место издания и издательство на иностранном языке, а также год, месяц, число, номер периодического издания, страницы.

2. Описательная часть, называющая тему и содержащая перечень основных положений оригинала или предельно сжатую характеристику материала.

3. Заключительная часть, подытоживающая изложения автора первоисточника. В этой же части приводятся ссылки на количество иллюстраций и библиографию.

## The Engine

The word *engine* originally meant any ingenious device, and came from the word *ingenious*, clever. Any kind of vehicle must be able to move. The ability demands power. A machine that produces mechanical power or energy is an engine or a power plant.

Engines present one of the most interesting groups of problems considered in the engineering field. One of the main problems is receiving the maximum possible power or thrust for minimum weight. The weight is included in the factor called the weight/power ratio, which may be defined as the weight in pounds per horse power output.

Another important problem is that of fuel. Both in the past and today the designers work at the problem of getting lower specific fuel consumption. Specific fuel consumption is obtained by dividing the weight of the fuel burned per hour by the horse power developed.

Another possible problem considered in any engine is its flexibility. Flexibility is the ability of the engine to run smoothly and perform properly at all speeds and through all variations of atmospheric conditions.

One more important problem worked at by the designers is the engine reliability. The engine is to have a long life, with maximum of time between overhaul periods? In some cases the problem of balance is one of the main. Balance has several possible meanings but the principle factor is freedom from vibration. Besides any engine must be started easily and carry its full load in a few minutes. There are gasoline engines, diesel engines, gas turbines, steam engines, jet engines and rocket engines. Each of them has certain advantages and disadvantages over other forms of power plants.

## Пример реферативного перевода

### Двигатель

Слово “двигатель” первоначально означало хитроумное устройство. Машина, которая производит механическую энергию или мощность, называется двигатель или силовая установка.

Одна из основных проблем, связанных с двигателем – это получение максимально возможной мощности или силы тяги при минимальном весе двигателя.

Другая важная проблема – это проблема топлива. Удельная величина потребления топлива получается путем деления массы сжигаемого топлива в час на развиваемую мощность (в лошадиных силах).

Другая возможная проблема, которая принимается во внимание в любом двигателе, это его гибкость. Гибкость – это способность двигателя работать ровно и надежно при любых скоростях и при всех изменениях погодных условий.

Еще одна важная проблема, над которой работают конструкторы - это надежность двигателя. Двигатель должен иметь продолжительный срок службы с максимальным временем между его переборками. Кроме того, двигатель должен легко запускаться и выдерживать полную нагрузку в течение нескольких минут.

Существуют бензиновый, дизельный, газовый, паровой, реактивный и ракетный двигатели.

### Аннотация

В данной статье рассматриваются вопросы усовершенствования технических характеристик двигателя. Особое внимание уделено увеличению мощности при минимальном весе; потреблению топлива, гибкости и надежности двигателя.

Статья рассчитана на широкий круг читателей, интересующихся вопросами усовершенствования двигателя.

## Литература:

1. Гвиненко, А. В. Современный автомобиль – как мы его видим. – М.: АСТ “Астерль”, Транзиткнига, 2005.
2. Гольд, Б.В. и др. Англо-русский словарь по автомобильной технике и автосервису. - Минск. Новая Звезда Лтд,1999.
- 3 Коваленко, А. Я. Общий курс научно-технического перевода: пособие по переводу с английского языка на русский. - Киев, «Фирма «ИНКОС»,2004.
4. Коваленко, А. Я. Науково – технічний переклад. – Тернопіль: Видавництво Карпюка 2004.
5. Орловская, И.В. Учебник англ. языка для технических университетов и вузов. - М., Изд-во МГТУ им. Н.Э.Баумана, 2001.
6. Слепович В.С. Курс перевода (английский - русский): Translation Course. - Мн.: ТетраСистемс, 2001.
7. Тверитнев М.В. Англо-русский и русско-английский автомобильный словарь. - М., “Russo”,1999.
8. Хоменко С.А. Основы теории и практики перевода научно – технического текста с английского языка на русский: учебное пособие.- Минск, БНТУ, 2004.

Статьи для перевода взяты из следующих аутентичных источников:

1. Automotive Engineering International. May-September,2002
2. Mercedes Magazine. Vol. 4,2000.
3. SAE 100 Future Look. A supplement to SAE International ,October 2005
4. Shiffer Michail Brian. Taking Charge. The electrical automobile in America. – Washington.: Smithson Press, 1994.
5. The MacMillan Visual Dictionary.- New York: MacMillan Publishing Company. 1992.
6. The Oxford-Duden Pictorial English Dictionary. – Oxford: Oxford University Press. 1985.
7. [www.howstaffworks.com](http://www.howstaffworks.com)
8. [www.onestopenglish.com](http://www.onestopenglish.com)
9. [www.insideout.com](http://www.insideout.com)

## СОДЕРЖАНИЕ

Unit 1. Basic Features of an Engine.....	4
Unit 2. <b>What Can Go Wrong</b> .....	12
Unit 3. Subsystems of Modern Engine.....	19
Unit 4. <b>Producing More Power</b> .....	27
Unit 5. <b>The New Golf R 32</b> .....	34
Unit 6. Vectra Aims For New Image.....	40
Unit 7. Hybrid Cars.....	47
Unit 8. <b>Internal Combustion Engine Valves and Valve Train</b> .....	54
Unit 9. The Light Green Powerhouse.....	61
Unit 10. Lexus SC 430.....	68
Unit 11. <b>The New Beetle 1.8</b> .....	74
Unit 12. Transport For Tomorrow.....	81
<b>Дополнительные тексты для перевода</b> .....	89
<b>Приложение</b> .....	98
<b>Литература</b> .....	103

Учебное издание

БОЯРСКАЯ Анна Олеговна  
СИМОНОВА Светлана Дмитриевна  
СЛЕСАРЕНОК Екатерина Викторовна

Пособие по практическому курсу научно-технического перевода  
для студентов технических специальностей автотракторного  
факультета

Технический редактор Л. Д. Мартынюк  
Компьютерная верстка Е. В. Слесаренок

---

Подписано в печать 31.05. 2006.

Формат 60X84 1/16 .Бумага офсетная.

Отпечатано на ризографе. Гарнитура Таймс.

Усл. печ. л. 4,7. Уч. - изд. л. 6,0. Тираж 500.

Заказ 400.

---

Издатель и полиграфическое исполнение:

Белорусский национальный технический университет.

ЛИ № 02330/-131627 от 01.04.2004.

220013, Минск, проспект Независимости, 65.

Министерство образования Республики Беларусь  
Белорусский национальный технический университет  
Кафедра английского языка № 1

Боярская А. О.  
Педько Л. В.  
Слесарёнок Е. В.

English for Transportation

Минск 2009

УДК 802.0-5(075.8):62

ББК 81.2Англ.я7

Б86

### **Рецензенты:**

старший преподаватель кафедры делового английского языка  
ФМБК БГЭУ Л. И. Василевская;

зав. кафедрой организации автомобильных перевозок и до-  
рожного движения, кандидат технических наук, доцент,  
В.Н. Седюкевич.

### **Боярская, А. О.**

English for transportation / А.О. Боярская, Л.В.Педько, Е.В.  
Слесарёнок. – Мн.: БНТУ, 2009. – 111 с.

Пособие предназначено для формирования и развития на-  
выков и умений перевода английских научно-технических  
текстов и овладения профессиональной лексикой студентами  
старших курсов автотракторного факультета специальности  
«Организация перевозок и управления на автомобильном и  
городском транспорте». В пособие включены оригинальные  
(аутентичные) тексты и упражнения, направленные на изуче-  
ние лексических и грамматических явлений, характерных для  
научно-технической литературы, а также упражнения, на-  
правленные на поиск нужной информации в тексте и закреп-  
ление навыков аннотирования текста.

УДК 802.0-5(075.8):62

ББК 81.2Англ.я7

© Боярская А.О., Педько Л.В.,

Слесарёнок Е.В., 2009

© БНТУ, 2009



## Unit One: Road Transportation

---

Ex. 1. Mind the new words and expressions.

1. to assess – оценивать
2. domestication – одомашнивание(животных), приручение
3. emergence - выход; появление
4. emergency – чрезвычайное положение; авария
5. to follow - следовать за
6. hazardous – опасный, рискованный
7. lane – полоса движения
8. to maintain- поддерживать, обслуживать
9. maintenance – содержание и техническое обслуживание; уход; текущий ремонт
10. macadam -щебень
11. onwards – далее
12. pan-continental – пан-континентальный
13. to pave – мостить
14. to span - протянуться
15. stagecoach –дилижанс, почтовая карета
16. strip (air strip) - полоса (взлетно-посадочная полоса)
17. toll – пошлина, сбор, плата за проезд
18. trail – тропа, дорожка, след, временный путь
19. turnpike - главная магистраль; платная автодорога

Ex. 2. Match the word with the appropriate definition.

road, freeway (AmE), railway, ring road, slip road, bridge, turnpike, service road, achievement, trunk road

1. a very wide road in the US, built for fast travel.
2. a permanent track composed of a line of parallel metal rails fixed to sleepers, for transport of passengers and goods in trains.
3. a structure that spans and provides a passage over a road, railway, river, or some other obstacle.
4. a motorway for using of which a toll is charged.
5. something that has been accomplished, especially by hard work, ability, or heroism.

6. an open way, usually surfaced with asphalt or concrete, providing passage from one place to another.
7. a main road that bypasses a town or town centre.
8. a relatively narrow road running parallel to a main road and providing access to houses, shops, offices, factories, etc., situated along its length.
9. a short road connecting a motorway, etc., to another road.
10. a main road, esp. one that is suitable for heavy vehicles.

Ex. 3 Match the words and word combinations with the similar meaning.

- |                 |                  |
|-----------------|------------------|
| 1. emergence    | a) to evaluate   |
| 2. hazardous    | b) importance    |
| 3. toll         | c) frame         |
| 4. to assess    | d) to connect    |
| 5. structure    | e) appearance    |
| 6. purpose      | f) dangerous     |
| 7. to require   | g) to spread out |
| 8. to link      | h) charge        |
| 9. significance | i) objective     |
| 10. to expand   | j) to demand     |

Ex. 4. Choose the right variant for each word combination.

- |   |   |
|---|---|
| 1) the Silk Road                        | a) <b>трансконтинентальный торговый путь</b>          |
| 2) fall out of favor                    | b) <b>всепогодная трансконтинентальная магистраль</b> |
| 3) all-weather transcontinental highway | c) <b>дорога с твердым покрытием</b>                  |
| 4) mail coach service                   | d) <b>впасть в немилость</b>                          |
| 5) stage-coach                          | e) <b>колесное транспортное средство</b>              |
| 6) wheeled vehicles                     | f) <b>не скользкое покрытие</b>                       |
| 7) pan-continental trading route        | g) <b>работающий по расписанию</b>                    |
| 8) interstate highway                   | h) <b>в экстренных случаях</b>                        |
| 9) in case of an emergency              | i) <b>водостойкое дорожное покрытие</b>               |

- 10) solid road
- 11) operating under a timetable
- 12) waterproof road surfaces
- 13) non-slippery pavement

- ж) шелковый путь
- к) почтовая карета, дилижанс
- л) междуштатное шоссе
- м) почтовая служба

Ex. 5. Translate the following noun+noun construction into Russian.

- |   |                                       |
|---|---------------------------------------|
| 1. minimum cost network flow optimization | 7. information technology development |
| 2. land transportation networks           | 8. lorry road user charge             |
| 3. road freight transport                 | 9. road transport growth              |
| 4. high-quality road transport            | 10. land transport system             |
| 5. road damage cost                       | 11. short-term decisions              |
| 6. road freight haulage                   | 12. product life cycle                |

Ex. 6. Choose the right variant for each word combination. Mind the **use of the word 'road'**.

- |                   |                                  |
|-------------------|----------------------------------|
| 1) back road      | а) кольцевая (окружная) дорога   |
| 2) country road   | б) дорога с твёрдым покрытием    |
| 3) dirt road      | в) подъездная дорога             |
| 4) feeder road    | г) вспомогательная дорога        |
| 5) macadam road   | д) просёлочная дорога            |
| 6) merging roads  | е) въезд/съезд на автомагистраль |
| 7) ring road      | ж) платная дорога                |
| 8) secondary road | з) дорога местного значения      |
| 9) slip road      | и) немощёная, грунтовая дорога   |
| 10) toll road     | к) дорога, покрытая щебнем       |
| 11) surfaced road | л) сходящиеся дороги             |

Ex. 7. Read the text attentively, find international words, translate them into Russian. Say what you have learnt from the history of roads.

Two major modes are composing the land transport system, roads and railways. Obviously, roads were established first, as rail technology only became available by the 18th century, in the midst of the industrial revolution. Historical considerations are important in assessing the structure of current land transportation networks. Modern roads tend to follow the structure established by previous roads, as it was the case for the modern Euro-

pean road network (especially in Italy, France and Britain) that follows the structure established by the Roman road network centuries before.

The first land roads took their origins from trails which were generally used to move from one hunting territory to another. With the emergence of the first forms of nation-states trails started to be used for commercial purposes as trade expanded and some became roads, especially through the domestication of animals such as horses, mules and camels. The use of wheeled vehicles encouraged construction of better roads. However, a road transport system requires a level of labor organization and administrative control that could only be provided by a central government offering some military protection over trade routes. By 3,000 BC the first road systems appeared in Mesopotamia and asphalt was used to pave roads in Babylon by 625 BC. The Persian Empire had a road of 2,300 km in the 5th century BC. However, the first major road system was established by the Roman Empire from 300 BC and onwards, mainly for economic, military and administrative reasons. It relied on solid road engineering methods, including the laying of foundations and the construction of bridges. This was also linked with the establishment of pan-continental trading routes, such as the Silk Road, linking Europe and Asia by 100 BC.

Following the fall of the Roman Empire in the 5th century, integrated road transportation fell out of favor as most roads were locally constructed and maintained. Because of the lack of maintenance of many road segments, land transport became a very hazardous activity. It is not until the creation of modern nation-states in the 17th century that national road transportation systems were formally established. The French, through central government efforts, build their Royal Roads system spanning 24,000 km, over which a public transport service of stage-coaches carrying passengers and mail was established. The British, mainly through private efforts, built a 32,000 km system of turnpikes where tolls have to be paid for road usage. A similar initiative was undertaken in the United States in the 19th century and by the early 20th century, a network of 3 million km of roads, most unpaved, was in operation. 1794 marks the beginning of modern road transportation with the first mail coach service between London and Bristol, operating under a timetable.

Also of high significance were technological innovations in road engineering that permitted the construction of reliable and low cost hard surface roads. One such achievement came from the Scottish engineer McAdam who developed a process (later known as macadam) where hard and waterproof road surfaces were made by cemented crushed stone, bound together either with water or with bitumen. It provided a cheaper, durable, smooth and non-slippery pavement, which considerably improved the reliability and the travel speed on roads. Many roads could now be used year round.

Road development accelerated in the first half of the 20th century. By the 1920s, the first all-weather transcontinental highway, the Lincoln Highway, spanned over 5,300 km between New York and San Francisco. The Germans were however the first to build the modern highway (auto-bahn) in 1932 with specifications such as restricted access and road separation. The post World War Two era represented a period of rapid expansion of road transportation networks worldwide. The most remarkable achievement is without doubt the American Interstate highway system initiated in 1956. Its strategic purpose was to provide a national road system servicing the American economy and also able to support troop movements and act as air strips in case of an emergency. Overall, about 70,000 km of four-lane and six-lane highways were constructed, linking all major American cities, coast to coast. By the 1970s, every modern nation has constructed a national highway system, which in the case of Western Europe resulted in a pan-European system. This trend now takes place in many industrializing countries. For instance, China is building a national highway system that expanded to 25,000 km, with construction taking place at a pace of about 2,000 km per year.

Ex. 8. Answer the following questions.

1. When did trails start to be used for commercial purposes?
2. When and where did the first road system appear?
3. Why did land transport become a very hazardous activity in the 5<sup>th</sup> century?
4. What were technological innovations of high significance?
5. When did road development accelerate?
6. Every modern nation has constructed a national highway system by the 1970s, hasn't it?

Ex. 9.

1. (Вслед за падением) of the Roman Empire, (объединенные дорожные перевозки) fell out of favor as most roads were locally constructed and maintained. 2. The American (федеральная система скоростных автострад) was to provide a national road system servicing the American economy and also able to (поддерживать) troop movements and act as (взлетная полоса) (в экстренных случаях). 3. The use of (колесных транспортных средств) encouraged construction of better roads. 4. By the 1920s, the first (всепогодное) transcontinental (шоссе) spanned over 5,300 km between New York and San Francisco. 5. (Дорожная транспортная система) requires a level of (организация труда) and administrative control that could be (обеспечено) by a central (правительством) offering some military protection over (торговые пути). 6. The first road systems (появились) in Mesopotamia and asphalt was used (для того, чтобы мостить дороги) in Babylon by 625 BC. 7. Technological innovations in (дорожная техника) permitted the construction of (надежный) and (с низкой себестоимостью) (дороги с твердым покрытием). 8. The Germans were the first to build the modern highway (autobahn) in 1932 with specifications such as (ограниченный доступ) and (разделение дорог). 9 Overall, about 70,000 km of (4-х полосных) (магистралей) were constructed, linking all major American cities, coast to coast. 10. Historical considerations are important (при оценке) the structure of (современная сеть наземных перевозок). 11. The Scottish engineer McAdam (разработал) a process later known as (щебенка) which considerably improved the (надежность) and the (скорость передвижения) on roads and provided a cheaper, durable, (гладкий) and (не скользкую мостовую).

Ex. 10. Fill in the blanks with the suitable prepositions.

1. The most remarkable achievement is ... doubt the American Interstate highway system initiated ... 1956. 2. 1794 marks the beginning ... modern road transportation with the first mail coach service ... London and Bristol, operating ... a timetable. 3. The first land roads took their origins ... trails which were generally used to move ... one hunting territory ... another. 4. The first major road system was estab-

lished ... the Roman Empire and it relied ... solid road engineering methods, including the laying ... foundations and the construction ... bridges. 5. The Scottish engineer McAdam developed a process where hard and waterproof road surfaces were made ... cemented crushed stone, bound together either ... water or ... bitumen.

Ex. 11. Translate the following sentences into Russian. Mind the use of the participles.

1. Cars and trucks have improved in numerous respects, becoming far more reliable, safer and less polluting. 2. Being an engine of commerce, the logistics industry is fueled by the health of the overall economy. 3. Transport companies earn money being engaged in freight transportation instead of writing the accompanying documents. 4. Goods in lots which are too small for the traditional bulk transport can be moved using containers. 5. Indices showing cost developments for different kinds of road transport have to be published regularly. 6. The 1939 World Fair had exhibits indicating that almost everything in transport would operate automatically. 7. Vehicles travelling on the network include automobiles, bicycles, buses, trains, people and aircraft.

Ex. 12. Translate the following sentences into Russian. Mind the use of the emphatic constructions.

1. It is not until the creation of modern nation-states in the 17th century that national road transportation systems were formally established. 2. It was in the 1950s that the introduction of containerization gave massive efficiency gains in freight transport, permitting globalization. 3. It is only in recent years that traditional practices have started to be questioned in many places. 4. It is the density of development that depends on mode of transport, with public transport allowing for better special utilization. 5. It is different modes of transport that offer different levels of mobility and accessibility in different circumstances. 6. It is the inertial nature of transportation facility development and urban structure adjustments that make it difficult to keep up with a population's rapid shifts to motor vehicle.

Ex. 13. Give the main points of the text in 4-7 sentences. Use the following clichés:

*The text deals with... . The author points out that... . Attention is drawn to the fact that... . It is pointed out that... . It should be noted that... . The author comes to the conclusion that... . I find the text rather/very... .*

Ex. 14. Translate the text into Russian. Use the dictionary if necessary.

UNCTAD (United Nations Conference on Trade and Development) has suggested definitions to various types of transport so that a clear distinction could be established between multimodal transport and other forms of transport. Unimodal transport is the transport of goods by one mode of transport by one or more carriers.

Intermodal transport is the carriage of goods by several modes of transport from one point/port of origin via one or more interface points to a final port/point where one of the carriers organizes the whole transport. Depending upon the sharing of transport responsibility, different types of transport documents are issued. Under the another form of transport called segmented transport, the carrier takes responsibility for the portion it is performing itself, and accordingly issues an intermodal bill of lading.

Facilitation of trade and transport sectors calls for procedural, legal and institutional reforms to simplify, standardise and harmonise procedures and documentation that will help to achieve movement of goods at a minimum cost and time. This covers a wide spectrum of activities including human resource development, physical infrastructures, and the use of new transport and information technologies. Multimodal transport is one of highly effective and modern ways of facilitating movement of imports and exports. It is a transport logistic system based on new transport technology that ensures fast and safe movement of goods at least costs.

The rapid changes in political, economic and technological sectors in the aftermath of the Second Great War resulted in the tremendous growth in domestic production and international trade. The world started to witness ever growing competition as every country faced challenges as well as opportunities to raise one's share in the global trade. The concept of 'just-in-time' became the most wanted element in international trader. The traditional practice of holding large stock became an obsolete practice. Consequently this triggered new developments in, inter alia, transport technologies aimed at achieving higher efficiency with reduced



cost and transit time in delivering products from one part of the world to the another. In the course of its development, the multimodal transport used to be called with variety of names such as intermodal transport, through transport and combined transport.

Multimodal transport is the most popular form of transport logistic system in the international trade for efficient door-to-door delivery using single document called a multimodal transport document (MTD) under a single liability regime covering all modes of transport from the place of origin to the place of destination. In other words, multimodalism refers to a transport system to effect door-to-door movement of cargo, and therefore, reflects a logical and flexible commercial system in international trade. It also means selling direct into the overseas market as easily as at home and in terms familiar to the customers.

## Unit Two: Road - the Lifetime of the European Single Market

---

---

Ex. 1. Mind the new words and expressions

1. agreement – соглашение, договор
2. allocation – размещение, распределение
3. authorization – санкционирование, разрешение
4. charge – расходы, издержки, налог, сбор
5. coach – пассажирский автобус, вагон
6. to codify – систематизировать
7. to comply – выполнять, осуществлять
8. crucial – наиболее значительный, важный
9. distorting – искажающий, деформирующий
10. to exercise - использовать, осуществлять, проявлять, применять
11. flexibility - гибкость
12. to hamper – препятствовать, мешать
13. haulage – перевозка, транспортировка
14. impact – сильное воздействие, удар, толчок
15. legislation - законодательство
16. levy (v, n) – сбор, взимание пошлин, налогов
17. in regard to – в отношении, что касается

- 18. saturation – насыщение
- 19. to settle – регулировать, устанавливать
- 20. to strive – бороться, прилагать усилия
- 21. taxation – налогообложение, размер налога
- 22. toll (v, n) – пошлина, облагать платой за перевозку
- 23. to underpin - -поддерживать, подкреплять
- 24. victim – жертва

Ex. 2. Match the word with the appropriate definition.

legislation, operator, safety, toll, allocation, traffic, transport **café**

- 1. a person who owns or operates an industrial or commercial establishment.
- 2. an inexpensive eating place on a main route, used mainly by long-distance lorry drivers.
- 3. the act or process of making laws.
- 4. an amount of money levied for the use of certain roads, bridges, etc., to cover the cost of maintenance.
- 5. accounting a system of dividing overhead expenses between the various departments of a business.
- 6. freedom from danger or risk of injury.
- 7. the movement of vehicles, people in a particular place or for a particular purpose.

Ex. 3 Match the words and word combinations with the similar meaning.

- |                        |                     |
|------------------------|---------------------|
| 1) haulage             | a) duty             |
| 2) charge              | b) critical/ urgent |
| 3) toll                | c) therefore        |
| 4) levy                | d) equality         |
| 5) in regard to        | e) to classify      |
| 6) legislation         | f) to fulfill       |
| 7) consequently        | g) in respect to    |
| 8) crucial             | h) tax              |
| 9) to codify           | i) expenses, costs  |
| 10) to comply          | j) law              |
| 11) non-discrimination | h) transportation   |

Ex. 4. Choose the right variant for each word combination.

- |                            |  |
|----------------------------|--|
| 1) absorption              | a) грузовместимость транспортного средства   |
| 2) accessorial services    | b) пропускная способность пути сообщения   |
| 3) bridge toll             | c) совместное транспортное агентство (несколько предприятий)                           |
| 4) revenue unit of service | d) дополнительное обслуживание при перевозках  |
| 5) cargo-carrying capacity | e) принятие на себя обязательств другого перевозчика без увеличения стоимости доставки |
| 6) constructive mileage    | f) плотность транспортного потока  |
| 7) joint agents            | g) мостовой сбор   |
| 8) traffic capacity        | h) расчетная [калькуляционная] единица (тонно-миля\ машино-миля)                       |
| 9) traffic density         | i) условия дальности перевозки   |

Ex. 5. Find in the text international words and translate them into Russian.

Ex. 6. Read the text and say what you have learnt about European roads.

Day and night, hundreds of thousands of lorries travel across Europe's main arteries. This mode of transport has two major and obvious advantages: its flexibility and its ability to carry goods and passengers door-to-door. This is the reason why European companies clearly prefer the road network to distribute their products throughout the Union.

Road transport is clearly an important factor underpinning the development of the European internal market. The more this market opens up and becomes unified, the more the sector benefits in terms of its own growth.

Every operator in the sector has the right to settle and freely exercise his activities throughout the Union. The specific rules governing European road transport, in particular with regard to taxation and charges,

tolls and levies for the use of infrastructure, are made up by distinct national legislations. This regulatory mosaic is composed of numerous elements with unequal costs, distorting competition. It prevents the optimum allocation of resources and hampers competitiveness in this area of economic activity. The overall aim of the EU rules worked out in this sector has been to strive for clarity and open up the market in a balanced manner to the benefit of a large number of transport operators.

The road haulage sector is the victim of its own success. Its steady growth — together, of course, with that of car traffic — contributes to the increasingly frequent saturation of the capacity of Europe's roads. The need to share infrastructure with other road users also raises the important question of road safety. Another consequence of fundamental importance for the community is the impact on the environment, in particular in connection with greenhouse gas emissions and climate change. It is not that freight carried by road, using diesel, which is not the most polluting fuel, is the central element of this problem, but the ever-growing number of vehicles operating in European road transport, now over 20 million, is undeniably a contributing factor.

The sector of passenger transport by road shares with the road haulage sector a number of identical rights and obligations: freedom of establishment, access to the market, compliance with conditions of competition, vehicle safety and safe driving. Consequently, many EU rules applying to lorries also concern buses and coaches. From 1991 to 2001 their activity, measured in millions of passenger-kilometers, rose by about 10 %. Their modal share is limited to approximately 9 % of overall passenger transport (including cars, railways and air traffic). A significant percentage of these is made up of vehicles used for urban or inter-urban transport that are operated by transport companies under the supervision of the public authorities.

In a sector where safety is of crucial importance, the Union has codified and simplified the common administration procedures relating to various passenger transport scenarios: national authorization for regular services, possession of a contract for specific regular services (school transport, personnel transport, etc.), holding a road map for occasional services and a certificate for own-account services.

The Interbus agreement is a key instrument for liberalizing the important passenger road transport market between the Union and the countries

of central and Eastern Europe. The agreement comprises social, fiscal and technical measures based on non-discrimination among the various contracting parties. It governs not only traffic between the EU and non-member countries but also among the nonmember countries themselves. As such, it is a major step towards harmonising, within the Europe the rules and procedures which transport operators have to comply with.

Road transport plays a direct role in developing the European internal market. Moreover road transport also has to meet challenges connected with its success: network safety and saturation impact on the environment. The future of road haulage should therefore be viewed in the framework of an overall **medium-term vision of the Union's transport policy** as analyzed in the White Paper (European Transport Policy for 2010).

Ex. 7. Answer the following questions.

1. What are the major advantages of lorries?
2. What problems does the road sector have?
3. What procedures has the Union codified?
4. What is the Interbus agreement?
5. What challenges does road transport have to meet?

Ex. 8. Substitute the words in Russian with their appropriate equivalents in English.

1. The steady growth of ( **сектора дорожных перевозок**) contributes to the ( **насыщенность**) of the capacity of Europe's roads. 2. The Union has ( **систематизировал**) and simplified the ( **обычные**) administration procedures in a sector where ( **безопасность**) is of ( **чрезвычайно важна**) 3. The specific ( **правила**) governing European road transport include ( **налогообложение**) and charges, ( **пошлины**) and ( **сборы**) for the use of infrastructure, 4. Many EU ( **правила**) applying to ( **грузовики**) also concern buses and ( **пассажирские автобусы**) .5.The ever-growing number of ( **транспортные средства**) operating in European road transport, now over 20 million, is a contributing factor of the ( **воздействие**) on the ( **окружающая среда**), in particular in connection with ( **парниковый**) gas ( **выбросы**) and climate ( **изменение**). 6. The Interbus ( **соглашение**) comprises social, ( **финансовые и технические меры**) based on non-discrimination among the various ( **договаривающиеся стороны**), it is a

major step towards harmonizing, within the Europe (правила и процедуры) which transport operators have to (выполнять).7. The sector of (пассажирский транспорт) by road shares with the road (перевозки) sector a number of identical (права и обязательства): (доступ) to the market, (безопасность транспортного средства) and (безопасное вождение). 8. The need to (делить) infrastructure with other road (пользователи) raises the important question of (дорожная безопасность).

Ex. 9. Fill in the blanks with the suitable prepositions.

1. The aim of the EU rules worked ... in this sector has been to strive ... clarity and open up the market in a balanced manner to the benefit ... a large number of transport operators. 2. Day and night, hundreds of thousands ... lorries travel ... Europe's main arteries. 3. Road transport has the capacity ... carrying goods door ... door. 4. The Interbus agreement is a key instrument ... liberalizing the important passenger road transport market ... the Union and the countries ... central and Eastern Europe. 5. This agreement governs not only traffic ... the EU and non-member countries but also ... the nonmember countries themselves. 6. The Interbus agreement is a major step ... harmonising, ... the Europe the rules and procedures which transport operators have to comply with. 7. The modal share ... EU rules is limited to approximately 9 % ... overall passenger transport (including cars, railways and air traffic). 8. The need to share infrastructure ... other road users raises the important question ... road safety. 9. A significant percentage ... overall passenger transport is made up ... vehicles used ... urban or inter-urban transport that are operated ... transport companies ... the supervision ... the public authorities. 10. European companies prefer the road network to distribute their products ... the Union.

Ex. 10. Make up questions, the answers to which are given in the right-hand column.

What...?

Flexibility and ability to carry goods and passengers door to door.

Why...prefer the road network...?

To distribute their products throughout the Union.

<b>What...specific rules concerned to?</b>	Taxation and charges, tolls and levies for the use of infrastructure.
<b>What...?</b>	Open up the market to the benefit of transport operators.
<b>How many....?</b>	Over 20 million.
<b>What...?</b>	National authorization for regular services, possession of a contract, holding a road map and a certificate.
<b>What...?</b>	The Interbus agreement.
<b>What....?</b>	The impact on the environment in connection with greenhouse gas emissions and climate change.
<b>Why...the victim...?</b>	Saturation of the capacity of Europe's roads.
<b>When... by about 10 %.</b>	From 1991 to 2001.

Ex. 11. Translate the following sentences into Russian. Mind the use of the modal verbs.

1. Quality assurance must be built into the system, deviations must be detected and corrected before the consignee recognizes the problem, not afterwards. 2. The transport operator has to be able to predict and keep to time windows at both pick-up and delivery locations. 3. The transport market may be characterized as a highly regulated market with primitive mechanisms to match supply and demand. 4. There is little information on how road users might respond to a complex structure of charges and hence how effective a complex system might be. 5. In order to know where you need to get to, you must know where you were presently situated. 6. The challenge is to develop a masterplan on European transport, containing an overall vision on what should be achieved and how it should be achieved. 7. The shift from private car to public transport can be encouraged by a more efficient and comfortable transport system. 8. The role of the taxi in avoiding traffic jams should and could be enlarged.

Ex. 12. Translate the following sentences into Russian. Mind the use of the passive voice.

1. Changes in the supply of transport services are affected by human technologies, customer demand and external cost. 2. Many characteristics of transport demand are influenced by a multitude of simultaneously occurring tendencies. 3. In Helsinki the road dust problem is mainly blamed on winter sanding and has been addressed since the 1980s. 4. Transport and transporters are influenced by the changes in political and public opinion, by the rapid development of telecommunications and so on. 5. The capacity of existing European waterways is not fully utilized. 6. The need for sustainable mobility and alternative land use policies has recently been recognized. 7. For some agro industries the cost of the raw material waiting at the reception area is affected by the deterioration of the perishable products transported by trucks.

Ex. 13. Give the main points of the text in 4-7 sentences. Use the following clichés:

*The text deals with... . The author points out that... . It should be remembered that... . The author comes to the conclusion that... .*

Ex. 14. Translate the text into Russian. Use the dictionary if necessary.

#### About the International Road Federation

The International Road Federation is a non-governmental, not-for-profit organisation with over 650 members worldwide from both the public and private sector. It was founded in 1948. The mission of the IRF is to encourage and promote the development and maintenance of better and safer roads and road transport systems worldwide.

The IRF promotes education and understanding of the social and economic benefits to be derived from developing modern road networks, transport systems and traffic control; encourages and supports the planning and execution of economically and environmentally sound programmes to improve and extend road networks and allied systems; provides education and training programmes; cooperates with, advises and exchanges experiences with international, national and local organisations with goals similar to those of the IRF; advises on, assists and promotes the creation of national and regional road federations; collects, collates and distributes statistical, technical, economic, educational and other road-related material; stimulates and supports regional and



global harmonisation of standards; supports road research; encourages and promotes improvements in road safety.

The IRF also publishes World Road Statistics, the only global compilation of road and vehicle statistics. It is based on data from official sources within national statistics offices and national road administrations in more than 200 countries. It also benefits from increased IRF cooperation with major international institutions such as Eurostat and Afristat, and the UN Economic Commissions for Europe and for Africa.

Since it first appeared in 1958, World Road Statistics has been an indispensable reference tool for road professionals, statisticians, economists, journalists and development specialists around the world.

It is used by such agencies as the United Nations Development Programme, the World Bank, the European Commission and the CIA for their own publications: for example, the World Bank uses World Road Statistics to prepare a part of its own publication World Development Indicators.

## **Unit Three: London's Congestion Charge**

---

---

Ex. 1. Mind the new words and expressions

1. bus occupancy – **загруженность (вместимость) автобуса**
2. clamp (v, n) – **фиксировать, зажим**
3. congestion – **затор, пробка на дороге**
4. flat fee – **фиксированная оплата**
5. fine – **штраф, плата**
6. fossil fuel – **ископаемое топливо**
7. enforcement - **принудительное применение закона**
8. net revenue – **чистый годовой доход**
9. persistent - **стойкий, постоянный, продолжительный**
10. ridership – **(ж. д) пассажирские перевозки**
11. surveillance - **наблюдение**
12. to track – **следить, прослеживать**
13. transponder – **ретранслятор, радиомаяк**

Ex. 2. Match the word with the appropriate definition.

route, congestion charging, cost, to levy, profit, congestion, revenue

1. the state of being overcrowded, especially with traffic or people.
2. a way of reducing traffic in city centres by charging drivers money to enter.
3. the price paid or required for acquiring, producing, or maintaining something, usually measured in money, time, or energy.
4. to say officially that people must pay a tax or charge.
5. excess of revenues over outlays and expenses in a business enterprise over a given period of time, usually a year.
6. money that a business or organization receives over a period of time, especially from selling goods or services.
7. a way between two places that buses, planes, ships, etc. regularly travel.

Ex. 3 Match the words with the similar meaning.

- |                 |                |
|-----------------|----------------|
| 1) fine         | a) decrease    |
| 2) fee          | b) charge      |
| 3) track        | c) trace       |
| 4) reduce       | d) release     |
| 5) emission     | e) observation |
| 6) payment      | f) revenue     |
| 7) income       | g) penalty     |
| 8) surveillance | h) expense     |

Ex. 4. Give the Russian equivalents of the following expressions.

- |  |                             |
|--|-----------------------------|
| 1. congestion charge                             | 10. noise level             |
| 2. journey time reliability                      | 11. the charged area        |
| 3. efficiency of freight distribution            | 12. persistent non-payers   |
| 4. during working hours                          | 13. displaced car users     |
| 5. flat once-a-day fee                           | 14. road traffic emissions  |
| 6. an electronic road pricing system             | 15. fossil fuel consumption |
| 7. road-side transponders or on-board units      | 16. inner ring road         |
| 8. video-surveillance cameras                    | 17. (average) bus occupancy |
| 9. automatic number plate recognition technology | 18. traffic flow            |

Ex. 5. Choose the right variant for each word combination. Mind the **use of the word “charges”**.

- |                                   |   |
|-----------------------------------|---|
| 1) all charges borne              | a) <b>комиссионные</b>                    |
| 2) all charges included           | b) <b>транспортные расходы</b>            |
| 3) back charges                   | c) <b>накладные расходы</b>               |
| 4) basis for charges              | d) <b>расходы на погрузку и разгрузку</b> |
| 5) bill of charges                | e) <b>обратные расходы</b>                |
| 6) capital (depreciation) charges | f) <b>плата за хранение</b>               |
| 7) charges for delivery           | g) <b>расходы будущих лет</b>             |
| 8) charges from salary            | h) <b>включая все затраты</b>             |
| 9) commission charges             | i) <b>за покрытием всех расходов</b>      |
| 10) contracting charges           | j) <b>плата за перевозку груза</b>        |
| 11) customary charges             | k) <b>основание для платежей</b>          |
| 12) deferred charges              | l) <b>затраты на доставку</b>             |
| 13) freight charges               | m) <b>расходы, оговоренные договором</b>  |
| 14) handling charges              | n) <b>обычные расходы</b>                 |
| 15) overhead charges              | o) <b>счет расходов</b>                   |
| 16) storage charges               | p) <b>амортизационные отчисления</b>      |
| 17) transport charges             | q) <b>удержания из зарплаты</b>           |

Ex. 6. Look through the text and find the derivatives from the following verbs : *to rely, to distribute, to surveil, to enforce, to pay, to indicate, to signify, to improve, to occupy*.

Ex. 7. Read the text for more information about technology described.

**London’s Congestion Charge was introduced on 17 February 2003 with the aims of reducing congestion, improving bus services, improving journey time reliability and improving the efficiency of freight distribution and other services. Drivers entering the centre of the city during working hours must pay a flat, once-a-day fee. It is an electronic road pricing system which op-**

erates without road-side transponders or on-board units. Vehicles are tracked entering the charged area by video-surveillance cameras, using automatic number plate recognition technology.

This technology is employed for enforcement in urban and truck charging systems. Drivers entering the charged area between 7 a.m. and 6:30 p.m. Monday to Friday must pay 5 pounds (7 Euro), in advance or before the end of the day. Over half a million payments are made each week. Payments may be made by Internet, mobile phone SMS messages or at some petrol **stations and shops. On payment, the vehicle's registration number** is entered onto a computerized list and cross-checked against the video camera records. Fines are sent out to drivers of cars entering the zone without payment. Persistent non-payers are identified and their vehicles clamped, or in a few extreme cases their vehicles have been crushed.

The impacts of the system have been carefully monitored. The main results reported after the first complete year of operation are as follows, and closely in line with the results of the modeling on which the system was designed:

- Congestion within the zone has reduced by 30%, and the volume of traffic within the zone has reduced by 15%;
- Public transport is successfully accommodating displaced car users;
- There have been significant improvements to bus services in the zone and more widely throughout London;
- Comparative analysis of the many influences on the central London economy suggests that the direct impact of congestion charging on business activity has been small;
- Road traffic emissions and fossil fuel consumption in the zone have been reduced.
- Traffic entering the charging zone during charging hours has been reduced by 18%, and traffic circulating within the zone has been reduced by 15% (vehicles with four or more wheels). As predicted, there have been small increases in traffic on the inner ring road, just outside the charging zone, but this is being managed without significant additional congestion. There are no indications of significant increases in traffic outside the charging zone

Improvements to the bus network made in conjunction with the charging scheme have seen increased ridership both inside the charging zone and more widely. Reduced congestion on the roads has enabled more busses to

be run with much more reliable journey times. Average bus occupancy has increased but over-crowding has been avoided. Most of the net revenues generated by the charge are being invested in bus services.

By reducing overall volumes of traffic within the charging zone, and smoothing traffic flows, charging is estimated to be directly responsible for an approximate 12% reduction in emissions of both NO<sub>x</sub> and fine particles (PM<sub>10</sub>) from road traffic.. The reduction in CO<sub>2</sub> emissions from traffic is estimated to be 19%. No significant changes in noise levels have been recorded.

Generally the congestion charge has been accepted by the public and by business. The success of the charge has resulted in the Mayor proposing to extend the charged area to cover all of central London. The charging system and level of charge would stay the same and be applied to a single zone roughly double the size of the present charging area.

Ex. 8. Answer the following questions.

1. Why was **London's** Congestion Charge introduced?
2. What technology is employed for enforcement in urban and truck charging systems?
3. What were the main results after the first year of charging system operation?
4. How has the ecological situation been improved within the charging zone?
5. What has the success of charge resulted in?

Ex. 9. Substitute the words in Russian with their appropriate equivalents in English.

1. Road (**выбросы транспорта**) and fossil (**потребления топлива**) in the zone have been reduced. 2. (**Водители**) entering the centre of the city **during (в рабочее время)** must pay a (**фиксированную однодневную плату**). 3. Generally the (**затор**) charge has been accepted by the public and by business. 4. The (**влияние**) of the electronic (**система дорожных сборов**) have been carefully monitored. 5. Vehicles are (**отслеживаются**) entering the (**платная область**) by (**камеры видео наблюдения**) using automatic (**технология распознавания номерного знака**). 6. Reducing (**заторов на дорогах**) has enabled more busses to be run with much more (**надёжный**) journey times. 7. No (**значительных изменений**)

ний) in (уровень шума) have been recorded. 8. (Затор) and the (интенсивность движения) within the zone has (уменьшены). 9. (Штрафы) are sent out to drivers of cars entering the zone (без оплаты). 10. Average (наполняемость автобусов) has increased but (переполненность) has been avoided. 11. Most of the (чистая прибыль) generated by the charge are being invested in (автобусной службы). 12. By (уменьшения) overall volumes of (движения) within the charging zone, and (сглаживания) traffic (потоков), charging is estimated to be directly (ответственный) for (уменьшение выбросов) from road traffic.

Ex. 10. Translate the following sentences into Russian. Mind the use of the gerund.

1. For traffic management, there is a great deal of monitoring and an increase in the amount and reliability of information given to users. 2. Varying the charge by distance travelled within the UK ensures that all vehicles contribute equally irrespective of their country of registration or where they last refueled. 3. By easing traditional impediments (препятствия) to the international movement of goods, the TIR system encourages the development of international trade. 4. A market observation system for monitoring the transport market in case of disturbances enabling adequate interventions is needed. 5. There is little scope for reducing the annual tax on vehicle ownership further. 6. The extent of feeling unsafe when using public transport is relatively high. 7. Multimodal transport is one of highly effective and modern ways of facilitating movement of imports and exports. 8. Whatever the mode of transport, getting round in certain urban areas is becoming an increasingly time-consuming, difficult, uncomfortable, hazardous and stressful activity.

Ex. 11. Translate the following sentences into Russian. Mind the use of participle II.

1. Air pollution caused by intensive car, lorry and air traffic is finally starting to worry those who are most exposed to it. 2. One of the main measures considered by logistics managers of agro industries with continuous process is related to truck waiting times in the reception area. 3. The total journey time by public transport consists of the time taken to get to or from bus-stop, the waiting time and the time on board the vehicle. 4. The distribution services offered included warehousing, admin-

istration, order processing and the control of the goods flowing via the transport network. 5. Transport services provided in return for money can immediately be classed as third-party operations. 6. Based on a literature study and laboratory tests, full scale tests should be carried out on existing roads. 7. The investigation carried out is based on the data from the road surface measurements made on stale roads and accidents reported by the police.

Ex. 12. Give the main points of the text in 4-7 sentences. Use the following clichés:

*The text deals with... . The author points out that... . Attention is drawn to the fact that... . It is pointed out that... . It should be noted that... . The author comes to the conclusion that... . I find the text rather/very... .*

Ex. 13. Translate the following text into Russian. Use the dictionary if necessary.

United Kingdom plans to introduce a satellite based electronic km charge for trucks and trials of the technology began in 2004 on the motorways around the city of Leeds. Road infrastructure costs have been closely examined in the UK over many years and the existing fixed annual vehicle tax for trucks is differentiated according to axle weight and type of suspension in order to promote road friendly vehicles. This knowledge is expected to be used to differentiate the new electronic km charge to a relatively high degree, and this is the reason for preferring a satellite based system.

The information on the external costs of transport shows that these costs vary significantly by time of day, road type and area type.

The British Government proposes to start with a relatively simple structure of charges which succeeds in meeting the main objectives of the policy. These are: to ensure fairness and efficiency, so that all users contribute equally and at a level which reflects the costs they impose on the road network; to deliver environmental and other benefits by setting the rates so as to reflect the environmental performance of the vehicle paying the charge. The charge is expected to vary according to the distance traveled, vehicle type and road type.

Varying the charge by distance travelled within the UK ensures that all vehicles contribute equally irrespective of their country of registration or where they last refueled. Distinguishing by vehicle type ensures that the charge relates both to road damage costs and to environmental costs, with the heaviest vehicles with the fewest axles paying most and vehicles with more environmentally friendly emission standards paying less. The charge will also encourage operators to upgrade their fleets and make better use of their vehicles so as to reduce vehicle kilometers. Variation by road type further reflects the significant differences in costs between modern, high quality roads usually constructed to provide for freight traffic and other roads where road damage, environmental and safety costs are higher.

Using a satellite based system to levy the charge will allow for further variation to be implemented. There is likely to be the potential for varying the charge by time of day, so as to encourage operators to schedule their trips at times when they impose the lowest costs because the inter-urban network is less congested. A further option is a charge that varies by area type, to reflect the higher costs that heavy vehicles typically impose when operating in close proximity to people and their homes in urban areas. Both these options are unlikely to feature in the system when first implemented. The aim is to ensure that it is sufficiently flexible for it to be enhanced later.

The Government does not intend the new charge to increase the overall cost of road freight haulage for domestic operators in the UK. The aim is to reduce other taxes on UK road haulage so as to leave the overall costs broadly unchanged. There is little scope for reducing the annual tax on vehicle ownership (Vehicle Excise Duty) further. It is already highly graduated to encourage the purchase of environmentally friendly vehicles.

The Government concluded to repay part of the fuel duty paid by hauliers when they purchase fuel in the UK. Most fuel purchased by goods vehicle operators is either supplied directly to their depots or purchased in the course of a journey by drivers using special fuel cards. In both cases it would be a relatively simple matter for the suppliers of the fuel to claim a rebate from the tax authority and pass this on to the purchaser. There would also need to make arrangements whereby direct



purchasers of fuel could claim back the tax against a receipt from an authorised service station.

## Unit Four: Rush Hours

---

Ex. 1. Mind the new words and expressions

1. approach – **подход; подъезд**
2. avoidance – **избежание, уклонение**
3. to back – **поддерживать, подкреплять**
4. collision – **столкновение**
5. to encourage – **поощрять, поддерживать**
6. to enforce – **обязывать, вводить в действие**
7. grade – **уровень, степень**
8. image-recognition – **распознавание изображений**
9. interchange – **пересечение (дорожно-транспортное)**
10. intersection – **перекресток, пересечение**
11. grade-separated intersection – **дорожная развязка в двух уровнях**
12. junction – **перекресток, пересечение дорог**
13. grade junction – **пересечение дорог на одном уровне**
14. lane – **полоса движения;**
15. HOV – High Occupancy Vehicle – **машина, в которой едут два и более человека, включая водителя;**  
HOV lane – **полоса движения, выделенная для машин, в которых едут два и более человека включая водителя**
16. obstruction – **препятствие, затруднение продвижению**
17. offending - **нарушающий**
18. rush hour – **час пик**
19. ticket –(зд): **квитанция за нарушение правил уличного движения**
20. to issue ticket - **печатать квитанцию**
21. time-consuming – **отнимающий много времени**
22. turnpike road – **главная магистраль**
23. underneath - **под**
24. underpass – **подземный переход, тоннель, путепровод**
25. overtake – **обгонять**

Ex. 2. Match the word with the appropriate definition.

highway (AmE), rush hour, junction, collision, motorway (BrE), ticket

1. a wide main road that joins one town to another.
2. a main road for fast-moving traffic, having limited access, separate carriageways for vehicles travelling in opposite directions, and usually a total of four or six lanes.
3. a period at the beginning and end of the working day when large numbers of people are travelling to or from work.
4. a violent impact of moving objects; crash.
5. a piece of paper, cardboard, etc., showing that the holder is entitled to certain rights, such as travel on a train or bus, entry to a place of public entertainment, etc.
6. a point on a motorway where traffic may leave or join it.

Ex. 3. Match the words and word combinations with the similar meaning.

- |                     |                     |
|---------------------|---------------------|
| 1) to back          | a) crash            |
| 2) to ride          | b) offending driver |
| 3) intersection     | c) to drive         |
| 4) ticket           | d) to support       |
| 5) license plate    | e) coach            |
| 6) business day     | f) carpool lane     |
| 7) to encourage     | g) receipt          |
| 8) HOV lane         | h) working day      |
| 9) collision        | i) junction         |
| 10) bus             | j) number plate     |
| 11) speeding driver | k) to cheer         |

Ex. 4. Choose the right variant for each word combination.

- |                           |  |
|---------------------------|--|
| 1) limited access road    | a) <b>зеленая волна</b>                    |
| 2) collision avoidance    | b) <b>интенсивность движения в час пик</b> |
| 3) speed-measuring device | c) <b>отнимающий много времени</b>         |
| 4) green wave             | d) <b>дорога с ограниченным движением</b>  |
| 5) posted limit           | e) <b>разметка полос</b>                   |

- 6) business days
- 7) traffic congestion
- 8) four-way flashing lights
- 9) rush-hour traffic intensity
- 10) lane marking
- 11) grade-separated intersection
- 12) grade junction
- 13) minimum speed signs
- 13) time-consuming

- f) установленные ограничения
- g) дорожная развязка в двух уровнях
- h) пересечение дорог в одном уровне
- i) избежание столкновения
- j) устройство измерения скорости
- к) пробки на дорогах
- l) рабочие дни
- m) знаки ограничения минимальной скорости
- n) аварийная сигнализация

Ex. 5. Choose the right variant for each word combination. Mind the **use of the word "way"**.

**A)**

- 1) under way
- 2) no two ways about it
- 3) in many ways
- 4) in some ways
- 5) by way of
- 6) by the way
- 7) no way
- 8) the other way (round)

- a) во многих отношениях
- b) кстати
- c) полным ходом
- d) в некоторой степени
- e) ради, с целью
- f) наоборот
- g) ничего не выйдет
- h) двух мнений быть не может

**B)**

- 1) way bill
- 2) way cargo
- 3) way fare
- 4) way passenger
- 5) way side
- 6) way train
- 7) waybill destination

- a) обочина
- b) попутный пассажир
- c) пункт назначения согласно путевому листу
- d) накладная
- e) попутный груз
- f) пригородный поезд
- g) местный тариф

Ex. 6. Look at the title and say what information the text gives. Read the text attentively for the details.

### Rush Hours

The higher the speed of a vehicle, the more difficult collision avoidance becomes and the greater the damage if a collision does occur. Therefore, many countries of the world limit the maximum speed allowed on their roads. Vehicles are not supposed to be driven at speeds which are higher than the posted maximum.

To enforce speed limits, two approaches are generally employed. In the USA, it is common for the police to patrol the streets and use special equipment (Typically a RADAR Gun) to measure the speed of vehicles, and "pull over" any vehicle found to be in violation of the speed limit. In Brazil and some European countries, there are computerized speed-measuring devices spread throughout the city, which will automatically detect speeding drivers and take a photograph of the license plate (or number plate), which is later used for applying and mailing the ticket.

Another interesting mechanism that was developed in Germany is the **Grüne Welle, or green wave, which is an indicator that shows the optimal speed to travel for the synchronized green lights along that corridor.** This encourages drivers to travel at the posted limit in order to minimize stopping.

During business days in most major cities, traffic congestion reaches great intensity at predictable times of the day due to the large number of vehicles using the road at the same time. This phenomenon is called rush hour, although the period of high traffic intensity may exceed one hour.

Some cities adopt policies to reduce rush-hour traffic and pollution **and encourage the use of public transportation. For example, in São Paulo, Brazil each vehicle has a specific day of the week in which it is forbidden from traveling the roads during rush hour.** The day for each vehicle is taken from the license plate number, and this rule is enforced by traffic police and also by hundreds of strategically positioned traffic cameras backed by computerized image-recognition systems that issue tickets to offending drivers.

In the United States and Canada, several expressways have a special lane (called an "HOV Lane" - High Occupancy Vehicle Lane) that can

only be used by cars carrying two (some locations-three) or more people, and several cities offer a public telephone service where citizens can arrange rides with others depending on where they live and work. The purpose of these policies is to reduce the number of vehicles on the roads and thus reduce rush-hour traffic intensity. Uncontrolled traffic occurs in the absence of lane markings and traffic control signals. On roads without marked lanes, drivers tend to keep to the appropriate side if the road is wide enough. Drivers frequently overtake others. Obstructions are not uncommon.

In large cities, moving from one part of the city to another by means of ordinary streets and avenues can be time-consuming since traffic is often slowed by at-grade junctions, tight turns, narrow marked lanes and lack of a minimum speed limit. Therefore, it has become common practice for larger cities to build expressways or freeways, which are large and wide roadways with limited access, that typically run for long distances without at-grade junctions.

The words expressway and freeway have varying meanings in different jurisdictions and in popular use in different places; however, there are two different types of roads used to provide high-speed access across urban areas:

The freeway (in USA usage) or motorway (in UK usage) is a divided multi-lane highway with fully-controlled access and grade-separated intersections (no stops). Some freeways are called expressways, super-highways, or turnpikes, depending on local usage. Access to freeways is fully controlled; entering and leaving the freeway is permitted only at grade-separated interchanges.

The expressway (when the name does not refer to a freeway or motorway) is usually a broad multi-lane avenue, frequently divided, with some grade-level intersections (although usually only where other expressways or arterial roads cross).

Motor vehicle drivers wishing to travel over great distances within the city will usually take the freeways or expressways in order to minimize travel time. When a crossing road is at the same grade as the freeway, a bridge (or, less often, an underpass) will be built for the crossing road. If the freeway is elevated, the crossing road will pass underneath it.

Minimum speed signs are sometimes posted (although increasingly rare) and usually indicate that any vehicle traveling slower than 40 mph

(~65 km/h) should indicate a slower speed of travel to other motor vehicles by engaging the vehicle's four-way flashing lights. Alternative slower-than-posted speeds may be in effect, based on the posted speed limit of the highway/freeway.

Ex. 7. Provide answers to the questions below.

1. What is the first approach employed in the USA?
2. What mechanism was developed in Germany to enforce speed limits?
3. **How do the authorities in São Paulo, Brazil reduce rush-hour traffic and pollution?**
4. What is HOV Lane?
5. What is difference between freeway and expressway?

Ex. 8. Replace the words in Russian with their appropriate equivalents in English.

1. (Цель) of these policies is to (уменьшить) the number of vehicles on the roads and thus reduce (интенсивность движения в час пик). 2. (Знаки ограничения минимальной скорости) are sometimes posted and usually indicate that any (транспортное средство) traveling slower than 40 mph (~65 km/h) should indicate a slower (скорость) of travel to other motor vehicles by engaging the vehicle's (аварийные огни). 3. In some European countries there are (компьютеризированные устройства измерения скорости) spread throughout the city, which will automatically (определяют) speeding drivers and take a photograph of the (номерной знак) which is later used (для предъявления квитанции). 4. The freeway is a divided (многополостная) highway (с полностью контролируемым доступом) and (с дорожной развязкой в двух уровнях) (no stops). 5. Many countries of the world (ограничивают) the maximum (разрешенная скорость) on their roads. 6. The police patrol the streets and use special (оборудование) to detect any vehicle found to be in (нарушение скоростного режима). 7. Uncontrolled traffic occurs (при отсутствии разметки) and traffic control signals. 8. When a crossing road is (на том же уровне) as the freeway, (мост) or (тоннель, путепровод) will be built for the crossing road. 9. (Зеленая волна) or the **Grüne Welle in Germany is an indicator that shows (оптимальная скорость движения)** for the synchronized green lights along that corridor. 10. This rule is enforced by traffic police and also by hundreds of (стра-

тегически расположенными) traffic cameras (поддерживаемые) computerized image-recognition systems that (печатает квитанция) to (нарушающим) drivers. 11. (Доступ) to freeways is fully controlled; (въезд и выезд с автострады) is permitted only at grade-separated interchanges. 12. In large cities, moving from one part of the city to another by means of ordinary streets and (проспектами) can be (отнимающим много времени) since traffic is often (замедляется) by at-grade (перекрестках), tight (поворотах), narrow marked lanes and lack of a minimum (ограничение скорости).

Ex. 9. Fill in the blanks with the appropriate prepositions.

1. Several cities offer a public telephone service where citizens can arrange rides .... others depending ..... where they live and work. 2. Vehicles are not supposed to be driven ..... speeds which are higher than the posted maximum. 3. Freeways are large and wide roadways ..... limited access, that typically run ..... long distances ..... at-grade junctions. 4. Motor vehicle drivers wishing to travel ..... great distances ..... the city will usually take the freeways or expressways in order to minimize travel time. 5. If the freeway is elevated, the crossing road will pass ..... it. 6. .... business days ..... most cities, traffic congestion reaches great intensity ..... predictable times .....the day ..... the large number ..... vehicles using the road ..... the same time. 7. In some cities each vehicle has a specific day ..... the week ..... which it is forbidden ..... traveling the roads ..... rush hour.

Ex. 10. Translate the sentences into Russian, paying attention to the **different meanings of 'that'**.

1. Distinguishing by vehicle type ensures that the charge relates both to road damage costs and to environmental costs. 2. Manufacturers will use EDI (electronic data interchange) to link their distribution more closely with those of internal and external partners. 3. A balance needs to be struck between the requirements of the Customs authorities on the one hand and those of the transport operators on the other. 4. The great disadvantage of the bus is that it must share roads with other vehicle. 5. It is a well-known fact that men in general drive more than women. 6. One of the reasons why the original TIR system had to be modified was that in the early 1960's a new transport technique emerged: the marine contain-

er. 7. Transport is such a visible activity and such a politically sensitive one that is important public policy questions.

Ex. 11. Translate the following sentences into Russian. Mind the use of the infinitive.

1. Vehicles are not supposed to be driven at speeds which are higher than the posted maximum. 2. To enforce speed limits, two approaches are generally employed. 3. This encourages drivers to travel at the posted limit in order to minimize stopping. 4. Some cities adopt policies to reduce rush-hour traffic and pollution and encourage the use of public transportation. 5. The purpose of these policies is to reduce the number of vehicles on the roads and thus reduce rush-hour traffic intensity. 6. The tonnage transported is expected to decrease due to lighter products, and the average distance of transport is expected to increase due to the exploitation of scale economy in production costs. 7. For this traffic information to be of most value it must be accurate, up-to-the minute and communicated immediately to drivers already on the road. 8. The government does not intend the new charge to increase the overall cost of road freight haulage for domestic operators in the UK.

Ex. 12. Translate the sentences into Russian. Mind the use of the modal verbs.

1. If EU wants to have an integrated and prosperous economy, it has to build up an effective transport system. 2. An international haulage is characterized by the use of the so-called quota system meaning that haulers have to obtain the permit to be able to undertake international journeys. 3. Individual public transport users must be prepared to change buses. 4. Transport may not be the top energy-consuming sector but it still eats up a massive 30% of EC energy budgets. 5. Drastic measures should be taken to reduce the rate of 50,000 dead and 1,500,000 injured on European roads every year. 6. A set of high standard rules to protect the environment should be implemented for emissions, noise, clean engines, clean fuels, energy consumption, etc. 7. Small investments in the structure of some East European ports could improve the transport potential between East and West. 8. Enterprises that move freight to commercial facilities such as factories, stores and warehouses usually need to operate in coordination with operations and resource availability at receiving locations.



Ex. 13. Give the main points of the text in 4-7 sentences. Use the following clichés:

*The text deals with... . The author points out that... . Attention is drawn to the fact that... . It is pointed out that... . It should be noted that... . The author comes to the conclusion that... . I find the text rather/very... .*

Ex. 14. Translate the following text into Russian. Use the dictionary if necessary.

In Verona, Italy, in November 2008, the International Association of Public Transport (UITP) and the Italian Public Transport Association (ASSTRA) joined the forces with Veronafiere to launch a new biennial event dedicated to the topic of public transport in small and medium-sized cities and rural areas. **“Often when we think about mobility and public transport, we automatically imagine a large city with crowded metros, trams and buses running at a high frequency. This however is only a part of the picture. Smaller cities have a different reality. They represent a significant part of the population and we should ensure that their mobility is given the attention it deserves,”** stated UITP Secretary General, Hans Rat.

Providing sustainable transport solutions in small cities and rural areas is not without its own special challenges. There are quite difficult conditions for public transport operators, with lower and more heterogeneous demand than in large cities (fewer people dispersed over a large area). Travelers are less captive to public transport than in larger urban areas. Public transport is generally limited to surface transport, in particular buses, which usually run in traffic alongside private modes. In this context it is not surprising that public transport is seen as less attractive option, and that the level of public transport usage is relatively low. **indeed this can be a vicious cycle. “A number of cities worldwide have proven that it is possible to break out of this vicious cycle and make public transport a preferred choice amongst many inhabitants of smaller cities,” explained Mr. Rat.**

Speed is a key factor to the success of public transport, and a number of smaller cities have shown that it is possible to perform well in this

regard. 'Buses of high level of service' or 'bus rapid transit' can provide a popular high-profile and rapid mode that combines the speed and image of light rail with the cost and flexibility of the bus.

A solution to low demand that has been tried in a number of cities is demand-responsive transport. Faced with the difficult challenge of low passenger numbers and high costs of scheduled lines, the city of Delémont in Switzerland opted for the introduction of a demand-responsive bus line, which proved to be hugely successful. In fact, the implementation of this alternative transport service made it possible to identify and re-launch demand and thus to return to a vastly improved normal line service. Economies of scale and better customer service can be achieved where there is good integration between neighbouring areas within one region, for instance in terms of services and ticketing. For instance in the Austrian city Graz, the introduction of an integrated ticketing system for the region led to a reduction in the user cost of public transport. In Freiburg im Breisgau, in Germany a successful integrated ticketing system unites 75 towns and municipalities around Freiburg, serving a population of 625,000 inhabitants.

## Unit Five: Transport, Energy and Environment

---

---

Ex. 1. Mind the new words and expressions

1. to account for- **объяснять, служить причиной**
2. aquatic - **водный**
3. consumption - **потребление, расход, издержки, затраты**
4. controversial – **спорный, сомнительный**
5. feasible – **вероятный, возможный, осуществимый**
6. fluid – **подвижный, изменчивый, нестабильный**
7. to guzzle –**потреблять что-либо чрезмерно**
8. incentive – **стимул, мотив**
9. to offset – **возмещать, компенсировать**
10. particulate – **твёрдая частица**

11. payout – выплата
12. performance – эксплуатационные характеристики
13. to plug in - подключать, включать в сеть
14. powertrain - силовая передача, трансмиссия
15. regenerative braking - рекуперативное торможение
16. runoff – отходы (промышленные)
17. sprawl – разрастание города ( застройка прилегающих территорий) urban sprawl - неконтролируемая застройка прилегающих к городу территорий
18. soot – сажа, копоть
19. streamline – (гл) упрощать, модернизировать, рационализировать; (сущ) линия обтекания, линия воздушного потока, обтекаемая форма
20. utility – полезность, выгода
21. vehicle fleet – парк транспортных средств

Ex. 2. Match the word with the appropriate definition.

impact, pollution, fuel, environment, contribute, infrastructure, shortage

1. a deficiency or lack in the amount needed, expected, or due; deficit.
2. the external surroundings in which a plant or animal lives, which tend to influence its development and behavior.
3. the force with which one thing hits another or with which two objects collide.
4. harmful or poisonous substances introduced into an environment.
5. to give (support, money, etc.) for a common purpose or fund.
6. any substance burned as a source of heat or power, such as coal or petrol.
7. the stock of fixed capital equipment in a country, including factories, roads, schools, etc., considered as a determinant of economic growth.

Ex. 3. Match the words with the similar meaning.

- |                  |                 |
|------------------|-----------------|
| 1) pollution     | a) questionable |
| 2) consumption   | b) use          |
| 3) controversial | c) motive       |
| 4) feasible      | d) effectual    |
| 5) incentive     | e) impulse      |

- 6) to offset
- 7) runoff
- 8) impact
- 9) propulsion
- 10) efficient

- f) waste
- g) to compensate
- h) possible
- i) contamination
- j) influence

Ex. 4. Choose the right variant for each word combination.

- |                                |   |
|--------------------------------|---|
| 1) traffic fluidity            | a) <b>глобальное изменение климата</b>                |
| 2) traffic flow                | <b>b) КПД двигателя</b>                               |
| 3) storage capacity of battery | c) <b>водные экосистемы</b>                           |
| 4) global climate change       | d) <b>содержание углерода</b>                         |
| 5) toxic runoff                | e) <b>установка дорожных знаков</b>                   |
| 6) aquatic ecosystems          | f) <b>токсичные отходы</b>                            |
| 7) carbon content              | g) <b>обновление парка машин</b>                      |
| 8) battery pack                | h) <b>поток транспорта</b>                            |
| 9) water supplies              | i) <b>время в пути</b>                                |
| 10) environmental regulations  | <b>j) нормативы по окружающей среде</b>               |
| 11) installing road signs      | k) <b>выбросы газов, вызывающих парниковый эффект</b> |
| 12) journey times              | l) <b>блок батарей</b>                                |
| 13) fleet renewal              | m) <b>подвижность транспортно-го потока</b>           |
| 14) lowering sulfur content    | n) <b>емкость аккумулятора</b>                        |
| 15) engine output              | o) <b>водоснабжение</b>                               |
| 16) greenhouse gas emission    | p) <b>снижение содержания серы</b>                    |
| 17) plant-based fuel           | q) <b>растительное топливо</b>                        |

Ex. 5. Look up the Russian equivalents of chemical terms in the dictionary.

petroleum  
carbon monoxide  
hydrocarbon fuels  
nitrous oxides  
carbon dioxide

hydrogen  
sulfur  
CO<sub>2</sub> emissions  
fossil fuels  
gasoline-ethanol blend

Ex. 6. Read the text attentively and learn how scientists try to solve ecological problems produced by transport.

Transport is a major use of energy, and transport burns most of the world's petroleum. Transportation accounts for 2/3 of all U.S. petroleum consumption.

The transportation sector generates 82 percent of carbon monoxide and 56 percent of NO<sub>x</sub> emissions and over one-quarter of total US greenhouse gas emissions. Hydrocarbon fuels also produce carbon dioxide, a greenhouse gas widely thought to be the chief cause of global climate change, and petroleum-powered engines, especially inefficient ones, create air pollution including nitrous oxides and particulates (soot).

Although vehicles in developed countries have been getting cleaner because of environmental regulations, this has been offset by an increase in the number of vehicles and more use of each vehicle.

Other environmental impacts of transport systems include traffic congestion and automobile-oriented urban sprawl, which can consume natural habitat and agricultural lands. Toxic runoff from roads and parking lots can also pollute water supplies and aquatic ecosystems.

Alternative propulsion can reduce pollution. Low pollution fuels may have reduced carbon content, and thereby contribute less in the way of carbon dioxide emissions, and generally have reduced sulfur, since sulfur exhaust is a cause of acid rain. The most popular low-pollution fuels at this time are biofuels: gasoline-ethanol blends and biodiesel. Hydrogen is an even lower-pollution fuel that produces no carbon dioxide, but producing and storing it economically is currently not feasible. Plug-in hybrids are energy-efficient vehicles that are going to be in the mass-production.

Another strategy is to make vehicles more efficient, which reduces pollution and waste by reducing the energy use. Electric vehicles use efficient electric motors, but their range is limited by either the extent of the electric transmission system or by the storage capacity of batteries. Electrified public transport generally uses overhead wires or third rails to transmit electricity to vehicles, and is used for both rail and bus transport. Battery electric vehicles store their electric fuel onboard in a battery pack. Another method is to generate energy using fuel cells, which may eventually be two to five times as efficient as the internal combustion

engines currently used in most vehicles. Another effective method is to streamline ground vehicles, which spend up to 75% of their energy on air-resistance, and to reduce their weight. Regenerative braking is possible in all electric vehicles and recaptures the energy normally lost to braking, and is becoming common in rail vehicles. In internal combustion automobiles and buses, regenerative braking is not possible, unless electric vehicle components are also a part of the powertrain; these are called hybrid electric vehicles.

To achieve real environmental objectives, attention should be focused on all motor vehicles, not just new vehicles. Features such as on board diagnostics systems can monitor engine output, while regular technical inspection reveals if vehicles are well-maintained and operating under optimal conditions.

It takes about ten years for the national vehicle fleet to be renewed. Providing incentives to replace old gas-guzzling vehicles with newer, fuel-efficient models, for instance payouts to scrap old vehicles, would speed up the process of fleet renewal and help reduce carbon gas emissions.

Oil companies are improving their petrol and diesel products, such as lowering sulfur content, to increase fuel efficiency, comply with the new environmental regulations and respond to new developments in engine technology.

Alternative fuels such as natural gas produce lower CO<sub>2</sub> emissions.

On the other hand, some experts think that plant-based fuels may not provide the answer to CO<sub>2</sub> emissions because of their negative overall energy and environmental performance from cultivation to final use.

Motor vehicles achieve optimal performance where traffic flow is most fluid. Ways of improving traffic fluidity, reducing congestion and hence lowering fuel consumption are:

- building new road infrastructure where necessary;
- improving current infrastructure;
- installing road signs providing both directions and information on

the road network to allow tourists to choose the best route.

In the United States, for example, Intelligent Transport Systems (ITS) are being installed in 75 of the largest urban areas, an investment that should help reduce journey times by 15%.

Shifting travel from automobiles to well-utilized public transport can reduce energy consumption and traffic congestion.

Walking and bicycling instead of traveling by motorized means also reduces the consumption of fossil fuels. While the use of these two modes generally declines as a given area becomes wealthier, there are some countries (including Denmark, Netherlands, Japan and parts of Germany, Finland and Belgium) where bicycling comprises a significant share of trips. Some cities with particularly high modal shares of cycling are Copenhagen (33%) and Groningen (50%). A number of other cities, including London, Paris, New York, Sydney, Bogotá, Chicago and San Francisco are creating networks of bicycle lanes and bicycle paths, but the value of such devices for utility cycling is highly controversial.

Ex. 7. Answer the following questions.

1. What is thought to be the chief cause of global climate change?
2. What are the other environmental impacts of transport system?
3. How can pollution be reduced?
4. What are the most popular low-pollution fuels?
5. What is another strategy to make vehicle more efficient?
6. What is the most effective way to generate energy?
7. How can real environmental objectives be achieved?
8. What are the major ways of improving traffic fluidity?
9. Do you know any other alternative ways to reduce the consumption of fossil fuels?

Ex. 8. Substitute the words in Russian with their appropriate equivalents in English.

1. Shifting travel from automobiles to well-utilized public transport can reduce (потребление энергии) and (пробки на дорогах). 2. Although vehicles in (развитых странах) have been getting cleaner because of (нормативы по окружающей среде), this has been (компенсировать) by an (увеличение) in the number of vehicles. 3. Ways of improving (подвижность трафика), (уменьшение заторов) and lowering (потребление топлива) include building new (дорожная инфраструктура), (улучшение) current infrastructure and (установка дорожных знаков). 4. (Характеристики) such as on board diagnostics systems can (контролировать) (КПД двигателя). 5. (Нефтяные) companies are (улучшают) their (бензиновый) and diesel products, such as (снижение содержания серы), to (увеличить эффективность топлива)

and respond to new (разработки) in engine technology. 6. Hydrocarbon (топливо) produce carbon dioxide, a (парниковый газ) thought to be the chief (причина) of (глобальное изменение климата), and (бензиновые двигатели) create (загрязнение воздуха). 7. (Для достижения) real environmental (целей), (внимание) should focus on all (моторные транспортные средства), not just new vehicles. 8. Motor vehicles achieve optimal (эксплуатационных характеристик) where (транспортный поток) is most (оживленный).

Ex. 9. Fill in the blanks with the appropriate prepositions.

1. To achieve real environmental objectives, attention should be focused .... **all motor vehicles**. 2. Regular technical inspection reveals if vehicles are well-maintained and operating ..... **optimal conditions**. 3. Electric vehicles use efficient electric motors, **but their range is limited** ..... **either the extent** .... **the electric transmission system** or .... **the storage capacity** .... **batteries**. 4. Toxic runoff ..... roads can pollute aquatic ecosystems. 5. **It takes** .... **ten years** ..... **the national vehicle fleet to be renewed**. 6. Installing road signs providing both directions and information ..... **the road network** allows tourists to choose the best route. 7. Shifting travel ..... **automobiles** ..... **well-utilized public transport** can reduce energy consumption and traffic congestion. 8. **A number** .... **cities** are creating **networks** ..... **bicycle lanes**, **but the value** ..... **such devices** ..... **utility cycling** is highly controversial.

Ex. 10. Translate the following sentences into Russian. Mind the use of the participle.

1. All papers mentioned provided valuable insight into the car rental business. 2. The costs of idle drivers and wasted fuel of the trucks while wafting in the lines are all important, but in second place if compared to the storage costs. 3. Changes in the manufacturing flow process lead to shorter cycle times, meaning improved responsiveness and efficiency of demand to customers. 4. The containers used in the beginning of the 19<sup>th</sup> century were much smaller than those we see today. 5. Increasing volumes of traffic mean an increased safety risk. 6. The form of public transport chosen by the individual passenger depends on comfort, information and personal general preference for the form of transport. 7. The longer the journey time, the greater the disadvantage which passengers



experience when changing buses. 8. Obviously, this deterioration is most marked in highly industrialized and densely populated areas.

Ex. 11. Translate the following sentences into Russian. Mind the use of the passive voice.

1. In mass production industries, most of the production plans are based on the estimation of market demand. 2. The project, Noise Innovation Program is being carried out by the Dutch Road Laboratory, which is expected to cost 55 million Euro. 3. Importance is placed on making use of each others' **expertise and special equipment**. 4. **Voices are now heard** calling for a significant and lasting way to reduce the consumption of energy by transport. 5. Transport is not viewed in isolation, but is closely linked with policies including those covering the environment, energy and safety. 6. Most seaport, inland waterways and pipelines networks are designed and realized specifically for movement of freight. 7. A comparison has been made between the transportation of containers by rail in the US and in Europe.

Ex. 12. Translate the following sentences into Russian. Mind the use of the compound prepositions and conjunctions.

1. Both passenger and goods transport have rapidly increased in the past years. 2. The poor state of road equipment, which has clearly been a cause of accidents, is not at all acceptable either in social or economic terms. 3. The management of car deployment is highly complex due to the connection of car availability across time, the station network and different car groups. 4. It is neither possible nor rational to develop a public transport system where all passengers can travel from door-to-door without exchanging buses. 5. Traffic signs and management systems are deteriorating due to intensive use, in part through damage and by poor maintenance. 6. A corporate station operates by means of staff and cars that are both part of the car rental company.

Ex. 13. Give the main points of the text in 4-7 sentences. Use the following clichés:

*The text is concerned with... . ... are considered . It should be noted that... . The fact that ... is stressed. It should be remembered that... . The author draws the following conclusion that... .*

Ex. 14. Translate the following text into Russian. Use the dictionary if necessary.

Cars and trucks are major sources of noise pollution in most cities. Most developed countries have had vehicle noise emission regulations since 1970s. Technological progress in engines and exhaust systems has made these vehicles considerably quieter. For example, the EU allowable noise level of a modern truck is approximately equivalent to that of the typical car in 1970. Nonetheless, the noise created by motorized transportation **remains a significant impact on urban residents' health and quality of life.** Noise is often cited as the main nuisance in urban areas, and traffic noise is the worst offender (a German study suggests that 65% of the population is adversely affected by road traffic noise, with 25% seriously affected).

As an indication, residential property values are measurably lower near noise-producing main roads, highways and railroad tracks. A recent study of Austrian schoolchildren found that the low but continuous noise of everyday local traffic can cause stress in children and raise blood pressure, heart rates. The research, conducted by US and European researchers, was the first major study of the nonauditory health effects of typical ambient community noise.

Besides vehicle engines and exhaust pipes, much of the noise produced by vehicles today, especially in highway operations, results from the movement of vehicles through the air, and the contact of tires with the road. The former can be reduced by aerodynamic vehicle body designs (which also have the effect of improving fuel efficiency and reducing emission). The latter can be reduced through tire thread designs and improvements in pavement surface textures (which also have the effect of draining water more effectively and so reducing the risks of accident).

Noise barriers can also minimize the impact of vehicle noise. Aircraft are another important source of noise. Major airports typically handle hundreds of thousands of aircraft arrivals and departures per year. Most of these aircraft are jet-propelled. In most of the developed world, increasingly stringent aircraft engine noise regulations have succeeded in

reducing the total noise exposure at most large airports. This is much less true, however, for the developing world. In many cases, aircraft that can no longer meet developed-world noise standards are sold to developing-world operators and continue their noisy existence.

## Unit Six: Transport in Cities

---

---

Ex. 1. Mind the new words and expressions

1. adverse - неблагоприятный, вредный
2. to affect – наносить вред, влиять
3. to cancel out – свести на нет
4. constraint – ограничение
5. to drive apart – отдалять друг от друга
6. dormitory – спальный пригород (район)
7. hazardous – опасный, рискованный
8. to hinder – мешать, препятствовать, задерживать, затруднять
9. intersection – перекресток, пересечение
10. log-jam - узкое место
11. node – узел, узловая точка
12. to play down – преуменьшать, умалять
13. relevant – существенный, важный
14. substantial – существенный, важный, значительный
15. smoothing – сглаживание, выравнивание
16. threshold – порог; ворота, вход
17. throughput – пропускная способность

Ex. 2. Match the word with the appropriate definition.

congestion, cost, agent, rush hour, interstate, transport, traffic jam.

1. a person who acts on behalf of another person, group, business, government, etc.; representative.
2. the state of being overcrowded, especially with traffic or people.
3. the amount of money that you have to pay in order to buy, do or produce something.
4. a wide road that goes between states, on which cars can travel fast.

5. the time of day, when the roads, buses, trains etc are most full, because people are travelling to or from work.
6. the business or system of transporting goods or people.
7. a long line of vehicles on a road that cannot move or can only move very slowly.

Ex. 3. Match the words with the similar meaning.

- |                 |                              |
|-----------------|------------------------------|
| 1. hazardous    | a) prerequisite              |
| 2. substantial  | b) unfavourable              |
| 3. impact       | c) insufficient              |
| 4. inadequate   | d) crossing                  |
| 5. condition    | e) dangerous                 |
| 6. play down    | f) substantial               |
| 7. intersection | j) influence                 |
| 8. relevant     | h) underestimate, understate |
| 9. adverse      | i) essential, important      |

Ex. 4. Choose the right variant for each word combination.

- |                             |  |
|-----------------------------|--|
| 1) combined transport       | a) <b>грузовой транспорт</b>   |
| 2) commercial transport     | b) <b>сухопутные перевозки</b>   |
| 3) cost of transport        | c) <b>грузовой автомобильный транспорт</b>   |
| 4) inland transport         | d) <b>транспортные издержки</b>  |
| 5) intercity transport      | e) <b>внутренний транспорт, перевозки внутри страны</b>  |
| 6) outwards transport       | f) <b>комбинированные перевозки</b>  |
| 7) overland transport       | g) <b>перевозки из страны</b>  |
| 8) facilities for transport | h) <b>международный транспорт</b>  |
| 9) urban mass transport     | i) <b>технологическая оснащённость транспорта</b>  |
| 10) goods transport         | j) <b>транспорт для пассажирских и грузовых перевозок (грузовые автомобили, автобусы, троллейбусы)</b> |
| 11) road freight transport  | k) <b>городской общественный транспорт</b>   |

Ex. 5. Scan the text to find answers to the following questions.

1. **What is the origin of the term ‘transportation’?**
2. What aspects does the field of transportation have?
3. What is important in cities to help public transport perform properly?
4. What are the main problems of urban transport sector?

Ex. 6. Read the text attentively for more information about different aspects of transport and transportation.

Transport or transportation is the movement of people and goods from one place to another. The term is derived from the Latin *trans* ("across") and *portare* ("to carry"). Industries which have the business of providing equipment, actual transport, transport of people or goods and services used in transport of goods or people make up a large broad and important sector of most national economies, and are collectively referred to as transport industries.

Transport is more than just another sector of the economy. Transport is the core of society. It gives a structure to space and our concept of space. It shapes and reflects our ways of life and our cultures. It contributes to economic development, whereas the economy depends on goods transportation. The functioning of society largely depends on the quality and design of the transportation system. A defective system will hurt society badly.

The field of transport has several aspects: infrastructure, vehicles, and operations. Infrastructure includes the transport networks (roads, railways, airways, waterways, canals, pipelines, etc.) that are used, as well as the nodes or terminals (such as airports, railway stations, bus stations and seaports).

An automobile is a wheeled passenger vehicle that carries its own motor. Different types of automobiles include cars, buses, trucks, and vans. Some include motorcycles in the category, but cars are the most typical automobiles. As of 2002 there were 590 million passenger cars worldwide (roughly one car for every ten people), of which 170 million in the U.S (roughly one car for every two people).

The automobile was thought of as an environmental improvement over horses when it was first introduced in the 1890s. In 2006, the automobile was recognized as one of the primary sources of world-wide air pollution and a cause of substantial noise pollution and adverse health effects.

Because of the much higher densities of people and activities, environmental, economic, public health, social and quality of life considerations and constraints are important in cities.

Urban transport has been led by professional transport planners and traffic experts. This has led in most cities to a substantial overbuilding of the road and supporting infrastructure, which has maximized throughput in terms of the numbers of vehicles and the speeds with which they pass through and move around in the built-up areas.

Too much infrastructure and too much smoothing for maximum vehicle throughput means that in many cities there is too much traffic and many - if not all - of the negative impacts that come with it.

The situation is most critical in the urban transport sector. Here, it is not just a matter of constraints on comfort and freedom to choose the means of transport – human safety and even freedom of movement are involved. Although urban networks are neither permanently nor totally log-jammed, congestion is a general phenomenon affecting all types of traffic and means of transport. Traffic jams – now inseparable from the urban scene – complicate the use of cars, buses and trams. Whatever the mode of transport, getting round in certain urban areas is becoming an increasingly time-consuming, difficult, uncomfortable, hazardous and stressful activity. Congestion is a daily fact on major roads, motorways, and at important traffic intersections. Although statistics shows a fall in accidents, the absolute numbers involved are still unacceptably high. In reality, the theoretically faster ride on the motorway is frequently cancelled out by congestion. Moreover, safety conditions created to cope with fewer and slower vehicles are inadequate to deal with present conditions. The quality of freight and passenger transportation and the economic function are affected.

The most common negative factors here are:

*Lack of safety.* The safety aspect in transportation is often – and wrongly – played down. It is highly relevant, particularly to road transport. Every year, 50,000 people are killed and a further 1,500, 000 are injured on European roads. The economic cost aside, this is totally unacceptable in human and social terms. Although figures have fallen in the long term, the annual body count is still far too high. The quality of safety on European roads is low.

*Noise:* Transport is a prime source of noise and vibration. These factors grow fast with traffic volume. In certain areas the noise levels now hinder normal work and living. Hence, instead of uniting people, transport can actually drive them apart. Indeed, it has actually transformed some residential areas into human deserts, particularly where these adjoin major urban arteries, highways, railway lines and airports. The quality of life in dormitory towns is affected.

*Traffic density:* Paradoxically, above a certain threshold, traffic density also hinders social relations. Very busy roads through villages and built-up areas can make trip hazardous and actually restrict free movement.

Ex. 7. Substitute the words in Russian with their appropriate equivalents in English.

1. (Затор) is a daily fact on major roads, (автомагистралях), and at important traffic (перекрестках). 2. The quality of (безопасности) on European roads is low. 3. Getting round in certain (городских) areas is becoming an increasingly (отнимающий много времени), difficult, uncomfortable, (опасный) and stressful activity. 4. The (качество) of life in (спальных районах) is affected by. 5. The (качество) of (грузоперевозок) and passenger transportation and the economic function are (наносится вред). 6. The (безопасность) aspect in transportation is highly (существенный) particularly to road transport. 7. In 2006, the automobile (был признан) as one of the primary sources of world-wide (загрязнение воздуха) and a (причина) of (существенное) noise pollution and (вредное влияние на здоровье). 8. Transport is a prime (источник шума) and vibration. 9. (Городские транспортные пробки) – now (неотделимы) from the (городских) scene – (усложняют) the use of cars, buses and trams. 10. In reality the theoretically faster ride on the motorway is frequently (сводится на нет) by congestion. 11. Too much infrastructure and too much smoothing for maximum (пропускной способности автомобилей) means that in many cities there is too much traffic and many negative (воздействия).

Ex. 8. Fill in the blanks with the appropriate prepositions.

1. Transport contributes ..... economic development, as the economy depends ..... good transportation. 2. Very busy roads ..... villages and

built-up areas can make trip hazardous. 3. Transport or transportation is the movement ..... people and goods ..... one place ..... another. 4. Traffic jams are now inseparable ..... the urban scene and complicate the use ..... cars, buses and trams. 5. Safety conditions created to cope ..... fewer and slower vehicles are inadequate to deal ..... present conditions. 6. Paradoxically, ..... a certain threshold, traffic density hinders social relations. 7. Congestion is a daily fact ..... major roads, motorways, and ..... important traffic intersections. 8. Transport has actually transformed some residential areas ..... human deserts.

Ex 9. Translate the sentences into Russian, paying attention to the multifunctional word “term”.

1. The economic cost aside, this is totally unacceptable in human and social terms. 2. Although figures have fallen in the long term, the annual body count is still far too high. 3. The term CIP - CARRIAGE AND INSURANCE PAID TO may be used for any mode of transport including multimodal transport. 4. The main goal of producers and sellers is to minimize costs for transportation and logistics and deliver goods to customers in possibly shorter terms. 5. Substantial overbuilding of the road and supporting infrastructure has maximized throughput in terms of the numbers of vehicles and the speeds with which they pass through and move around in the built-up areas. 6. Different configurations have different advantages and disadvantages in terms of smoothness, manufacturing cost and shape characteristics.

Ex. 10. Translate the sentences into Russian. Mind the different meanings of the verb *to be*.

1. Efficiently operating transport networks in the former segmented European space-economy are critical success factors for the competitive edge of Europe. 2. Competitive efficiency is in the centre of current European transport policy. 3. There is a major more recent policy concern on the question whether transport will be devastating for environmentally sustainable development. 4. The purpose of production logistics is to ensure that each machine and workstation is being fed with the right product in the right quantity and quality at the right point of time. 5. It is also through the physical distribution process that the time and space of customer service become an integral part of



marketing, thus it links a marketing channel with customers. 6. Transport is more than just another sector of the economy. 7. It is not just a matter of constraints on comfort and freedom to choose the means of transport. 8. Congestion is a daily fact on major roads, motorways, and at important traffic intersections. 9. Another strategy is to make vehicles more efficient, which reduces pollution and waste by reducing the energy use.

Ex. 11. Translate the sentences into Russian. Mind the use of the verbs in passive voice.

1. The automobile was thought of as an environmental improvement over horses when it was first introduced in the 1890s. 2. In 2006, the automobile was recognized as one of the primary sources of world-wide air pollution and a cause of substantial noise pollution and adverse health effects. 3. Urban transport has been led by professional transport planners and traffic experts. 4. Production logistics can be applied in existing as well as new plants. 5. The term is primarily intended to be used when goods are to be carried by rail or road, but it may be used for any mode of transport. 6. The term DDP - Delivered Duty Paid may be used irrespective of the mode of transport.

Ex. 12. Give the main points of the text in 4-7 sentences. Use the following clichés:

*The text deals with... . The author points out that... . Attention is drawn to the fact that... . It is pointed out that... . It should be noted that... . The author comes to the conclusion that... . I find the text rather/very... .*

Ex. 13. Translate the following text into Russian. Use the dictionary if necessary.

### Traffic Control

Nearly all roadways are built with devices meant to control traffic. Most notable to the motorist are those meant to communicate directly with the driver. Broadly, these fall into three categories: signs, signals or pavement markings. They help the driver navigate; they assign the right-of-way at intersections; they indicate laws such as speed limits and parking regulations; they advise of potential hazards; they indicate passing

and no passing zones; and otherwise deliver information and to assure traffic is orderly and safe.

200 years ago these devices were signs, nearly all informal. In the late 19<sup>th</sup> century signals began to appear in big cities at a few highly congested intersections. They were manually operated, and consisted of semaphores, flags or paddles, or in some cases colored electric lights, all modeled on railroad signals. In the 20<sup>th</sup> century signals were automated, at first with electromechanical devices and later with computers. Signals can be quite sophisticated: with vehicle embedded in the pavement, the signal can control and coordinate the turning movements of heavy traffic in the most complex of intersections. In the 1920s traffic engineers learned how to coordinate signals along a thoroughfare to increase its speeds and volumes. In the 1980s, with computers, similar coordination of whole networks became possible.

In the 1920s movement markings were introduced. Initially they were **used to indicate the road's centerline. Soon after they were coded with** information to aid motorists in passing safely. Later, with multilane roads they were used to define lanes. Other uses, such as indicating permitted turning movements and pedestrian crossing soon followed.

In the 20<sup>th</sup> century traffic control devices were standardized. Before then every locality decided on what its devices would look like and where they would be applied. This could be confusing, especially to traffic from outside the locality. In the United States standardization was first taken at the state level, and late in the century at the federal level. Each country has a Manual of Uniform Traffic Control Devices (MUTCD) and there are efforts to blend them into a worldwide standard.

Besides signals, signs and markings, other forms of traffic control are designed and built into the roadway. For instance, curbs and rumble strips can be used to keep traffic in a given lane and median barriers can prevent left turns and even U-turns.

## Unit Seven: Transportation and Logistics

---

---

Ex. 1. Mind the new words and expressions

1. auction – аукцион, торг; продавать с аукциона;

2. to accomplish – **выполнять, совершать**
3. carrier– **транспортное средство, перевозчик**
4. destination – **пункт назначения;**
5. to facilitate - **содействовать, способствовать, облегчать**
6. implementation – **выполнение, реализация, внедрение**
7. inventory – **материально-техническая база**
8. item – **продукт, изделие, отдельный предмет, пункт, статья**
9. life cycle – **жизненный цикл (изделия), период эксплуатации**
10. logistics – **материально-техническая база**
11. notably – **особенно, в особенности**
12. probability – **вероятность. возможность**
13. repositioning – **изменение положения, переустановка**
14. reverse auction - **обратный аукцион( аукцион, в котором участвует один покупатель и несколько конкурирующих продавцов)**
15. simultaneously – **одновременно, совместно**
16. supply chain – **логистическая цепочка, цепочка поставок, сеть поставок**
17. transaction - **сделка, соглашение**
18. warehousing - **складирование**

Ex. 2. Match the word with the appropriate definition.

consumer, producer, auction, client, contract, carrier

1. a person or business enterprise that generates goods or services for sale.
2. a person, thing, or organization employed to carry goods, passengers, etc.
3. someone who gets services or advice from a professional person, company or organization.
4. someone who buys and uses products and services.
5. an official agreement between two or more people, stating what each will do.
6. a public sale of goods or property, esp. one in which prospective purchasers bid against each other until the highest price is reached.

Ex. 3. Match the words and word combinations with the similar meaning.

- |                  |             |
|------------------|-------------|
| 1) goal          | a) usual    |
| 2) to facilitate | b) partaker |
| 3) to benefit    | c) rivalry  |

- 4) simultaneously
- 5) decrease
- 6) conventional
- 7) competition
- 8) participant
- 9) implementation
- 10) carrier
- 11) transaction
- 12) warehouse

- d) at the same time
- e) forwarder
- f) aim
- g) to profit
- h) realization
- j) to assist
- k) decline
- l) storehouse
- m) deal

Ex. 4. Choose the right variant for each word combination.

- 1) open and fair competition
- 2) to minimize costs

- a) в возможно короткие сроки
- b) реализация новых технологий

- 3) unprecedented amount of participants

- c) поставка товаров до места назначения

- 4) in possibly shorter terms

- d) снизить затраты

- 5) at possibly lower costs

- e) в данной ситуации

- 6) implementation of new technologies

- f) снижение затрат на перевозки

- 7) deliver the goods to the destination

- g) открытая и честная конкуренция

- 8) decrease of costs of transportation

- h) беспрецедентное количество участников

- 9) in the current situation

- i) цепочка поставок

- 10) supply chain

- j) по наименьшей цене

Ex. 5. Look up the meaning of the word combination in a dictionary.

**At large...and...in particular**

Consequently

It is worthy to note

Moreover

As a rule

Furthermore

As a result

Primarily

It is necessary to point out

It is logical to wonder

Ex. 6. Scan the text to find answers to these questions.

1. What does logistics management do?

2. What are the main functions of a qualified logistician?
3. What are the goals of producers and sellers in transportation?
4. What are the advantages of electronic reverse auctions compared to conventional auctions?
5. What is the effect of open competition in electronic reverse auctions?

Ex. 7. Read the text attentively and say what you have learnt about transportation, logistics and electronic auctions.

Logistics is the art and science of managing and controlling the flow of goods, energy, information and other resources like products, services and people from the source of production to the marketplace. It is difficult or nearly impossible to accomplish any international trading, global export/import processes, international repositioning of raw materials/products and manufacturing without a professional logistical support. It involves the integration of information, transportation, inventory, warehousing, material handling, and packaging. The operating responsibility of logistics is the geographical repositioning of raw materials, work in process and finished inventories where required at the lowest cost possible.

Logistics is an idea considered to have transformed from the military's need to supply them as they moved from their base to a forward position.

Logistician is the profession in the logistics & transport sectors, including sea, air, land and rail modes.

Logistics management is that part of the supply chain which plans, implements and controls the efficient, effective forward and reverse flow and storage of goods, services and related information between the point of origin and the point of consumption in order to meet customers' requirements. A professional working in the field of logistics management is called a logistician.

Supply Chain can be defined as having the right item in the right quantity at the right time at the right place for the right price and is the science of process and incorporates all industry sectors. The goal of logistics work is to manage the fruition of project life cycles, supply chains and resultant efficiencies.

The main functions of a qualified logistician include inventory management, purchasing, transportation, warehousing, consultation and the

organizing and planning of these activities. Logisticians combine a professional knowledge of each of these functions so that there is a coordination of resources in an organization. There are two fundamentally different forms of logistics. One optimizes a steady flow of material through a network of transport links and storage nodes. The other coordinates a sequence of resources to carry out some project.

\*\*\*\*\*

Traditionally, logistics and transportation are extremely important for successful operating of any company as well as the whole market at large. As a rule, the main goal of producers and sellers, as well as buyers, is to minimize costs for transportation and logistics and deliver goods to customers in possibly shorter terms. In the current situation, a variety of tools is used to achieve this goal. Innovative technologies, especially IT, computing, Internet, etc., are playing increasingly more important role and are commonly used to facilitate transportation and logistics.

As a result, auctions, using an electronic reverse auction platform, are growing to be popular and widely spread. It is necessary to point out that electronic reverse auctions have a lot of advantages compared to conventional auctions. Primarily, electronic reverse auctions may lead to a successful cooperation between producers of different goods to transport to various destinations and carriers. It is logical to wonder what both producers and carriers benefit from such cooperation which may lead to increasing of speed of transactions since producers receive not only the possibility to sell their goods but, at the same time, they have got a possibility to find a carrier that can deliver the goods to the destination. In such a way, two operations could be run simultaneously that seems to be extremely beneficial for sellers, i.e. producers.

Furthermore, the reverse auction provides producers with the possibility to choose from a large amount of carriers. In such a situation, the essential conditions for open and fair competition are created since producers can choose carriers on the basis of objective principles identical for all participants of the auction. On the other hand, carriers can supply their services to a large number of sellers and, consequently, can also easily find their potential customer.

Moreover, the open competition stimulates carriers to the improvement of their services and it may also result in certain decrease of costs of transportation for producers. Implementation of new technologies, notably elec-

tronic reverse auctions leads to the implementation of high technologies in transportation and logistics at large. It also opens new perspectives for reverse auctions since, being based on electronic platform, they can involve unprecedented amount of participants. Consequently, the probability that producers will find their clients and carrier, which will transport the goods to the destination at possibly lower costs, increases.

Thus, taking into account all above mentioned, it is possible to conclude that the implementation of electronic reverse auctions leading to better cooperation between producers and carriers perfectly demonstrates the possibilities of new technologies applied to business at large and transportation and logistics in particular.

Ex. 8. Substitute the words in Russian with their appropriate equivalents in English.

1. Logistics management is that part of the (цепочки поставок) which implements and controls (прямой и обратный поток товаров) between the point of origin and (пунктом потребления) in order to meet (запросы потребителей). 2. It is necessary to point out that electronic reverse auctions have a lot of (преимуществ) compared to (обычный) auctions. 3. The main (цель) is to minimize (затраты) for transportation and logistics and deliver goods to customers (в возможно короткие сроки). 4. The main functions of a qualified (логиста) include inventory management, (покупку), transportation, (складирование), consultation and the organizing and planning of these activities. 5. (Внедрение) of electronic reverse auctions leads to better (сотрудничество) between producers and carriers. 6. The open (конкуренция) stimulates carriers to the (улучшение) of their services and it may also result in certain (уменьшение расходов) of transportation for producers. 7. Two operations could be run (одновременно) that seems to be extremely (выгодно) for sellers. 8 The essential conditions for (открытая и честная) competition are created. 9. (Перевозчики) can (поставлять свои услуги) to a large number of sellers and, (следовательно), can also easily find their potential (потребителя). 10. Professional (логистическая поддержка) involves the integration of information, transportation, (материально-техническая база), material handling, and packaging. 11. (Логистическая цепочка) can be defined as having the (соответствующий предмет) in the (соответствующем количестве) at the (со-

ответствующее время) at the (соответствующем месте) for the (соответствующую цену) and is the science of process and incorporates all industry sectors. 12. It is difficult or nearly (невозможно) to (совершать) any international (торговлю) global export/import process, international (изменения положения) of (сырьевых) materials and manufacturing without professional (логистическая поддержка).

Ex. 9. Fill in the blanks with the appropriate prepositions.

1. The reverse auction provides producers .... the possibility to choose ..... a large amount of carriers. 2. Carrier will transport the goods .... the destination ..... possibly lower costs. 3. Producers can choose carriers ..... the basis of objective principles identical ..... all participants of the auction. 4. Both producers and carriers benefit ..... such cooperation. 5. Logistics is the art and science of managing and controlling the flow of goods... the source of production ... the marketplace. 6 It is difficult to accomplish any international trading .... a professional logistical support.. 7. Logistics management plans the flow and storage of goods ... the point of origin and the point of consumption. 8. Supply Chain can be defined as having the right item ... the right quantity ... the right time ... the right place ... the right price.

Ex. 10. Choose the right variant for each word combination.

- |                                      |   |
|--------------------------------------|---|
| 1) available inventory               | a) сезонный запас   |
| 2) book inventory                    | b) запасы в пути (на момент учета находящиеся в процессе перевозки)   |
| 3) finished goods inventory          | c) максимальный запас (сумма текущих, подготовительных, страхового запасов при превышении которых образуются излишки) |
| 4) lot-size inventory                | d) уровень запасов  |
| 5) replenishment of inventories      | e) запас вспомогательных материалов   |
| 6) projected inventory turnover rate | f) запасы готовой продукции   |
| 7) supply inventory                  | g) наличные запасы  |
| 8) taking inventory                  | h) затраты на формирование и  |



9) target inventory level	хранение запасов i) прогнозируемый коэффициент оборачиваемости запасов
10) seasonal inventory	j) восстановление уровня запасов
11) in-transit inventory	к) инвентарный учет товарно-материальных запасов)
12) inventory and valuation policy	l) страховой полис с описью и оценкой
13) inventory balance	м) текущие запасы
14) inventory carrying charge rate	п) стоимость хранения запасов
15) inventory carrying costs	о) проведение инвентаризации

Ex. 11. Translate the following sentences into Russian. Mind the use of the infinitive.

1. In order to respond to random orders from consumers and to stabilize the production process, inventories are maintained at sections of the production process. 2. The ability to communicate almost instantaneously, large amounts of information and data to suppliers, customers and transport providers has allowed firms to operate with increased efficiency. 3. It is critical to predict how a particular shift in logistics will affect the demand for transport services and how a shift in transport production will affect the infrastructure system. 4. To keep costs down and avoid an increase in the number of trucks on the roads, shipments must be consolidated. 5. For the European economy to operate as a single market there has to be presence of common transport policy. 6. The purpose of the cooperation is to make it possible to support research and development activities on road traffic noise of common interest to the two parties. 7. To protect their own market share the national companies will not compete with other smaller and regional companies.

Ex. 12. Translate the sentences into Russian, paying attention to the emphatic construction.

1. It is a transport logistic system based on new transport technology that ensures fast and safe movement of goods at least costs. 2. It was not until **the 1980's that environmental impacts were considered.** 3. **It is the aim** of the Danish Road Institute that pavements cause as little noise as poss-

ible for the sake of the neighbors and yet are safe to use for the road users. 4. It was in the early 1900s that closed container boxes designed for movement between road and rail were adopted. 5. It was Harvard University economist Benjamin Chinitz predicted that containerization would benefit New York by allowing it to ship industrial goods produced there more cheaply to the Southern United States than to other areas. 6. It was not until the 1950s that containers started to revolutionize freight transportation.

Ex. 13. Give the main points of the text in 4-7 sentences. Use the following clichés:

*The text is about... . It is shown that... . In the opinion of the author it is ... . Of special interest is his argument that... . The author concludes by saying that... .*

Ex. 14. Translate the following text into Russian. Use the dictionary if necessary.

Multimodal transport is one of highly effective and modern ways of facilitating movement of imports and exports. It is a transport logistic system based on new transport technology that ensures fast and safe movement of goods at least costs.

Facilitation of trade and transport sectors calls for procedural, legal and institutional reforms to simplify, standardise and harmonise procedures and documentation that will help to achieve movement of goods at a minimum cost and time. This covers a wide spectrum of activities including human resource development, physical infrastructures, and the use of new transport and information technologies. Multimodal transport is one of highly effective and modern ways of facilitating movement of imports and exports. It is a transport logistic system based on new transport technology that ensures fast and safe movement of goods at least costs.

The United Nations Convention on International Multimodal Transport of Goods of 1980 defines multimodal transport as " the carriage of goods by at least two different modes of transport on the basis of a multimodal transport contract from a place in one country at which the goods are taken in charge by the multimodal transport operator (MTO) to a place designated for delivery situated in a different

country". The definition has clearly identified four basic characteristics of multimodal transport such as the use at least two modes of transport, transfer of goods between two countries, issuance of a transport contract and the performance by a multimodal transport contractor taking in charge of whole movement of cargo.

A multimodal transport contract is a contract whereby a multimodal transport operator undertakes against payment of freight, to perform, or to procure the performance of international multimodal transport. This is performed through the issuance of an MTD as an evidence of the multimodal transport contract, taking in charge of the goods with an undertaking by the MTO, to deliver the goods in accordance with the contract terms.

## Unit Eight: FIATA

---

Ex.1. Mind the new words and expressions.

1. barcode – **штрих код**
2. to bring forward – **выдвигать ( предложение)**
3. dissemination, - **распространение**
4. distribution - **распространение**
5. distinctive – **отличительный, характерный**
6. distinguishable – **различимый, отличимый**
7. to enhance – **увеличивать, улучшать, усиливать**
8. to evaluate – **оценивать**
9. to familiarise – **ознакомлять**
10. forwarder (forwarding agent) – **экспедитор, перевозчик**
11. freight - **груз, фрахт**
12. HQ headquarter - **штаб**
13. institute – (зд.) **ассоциация**
14. liability insurance – **страхование ответственности**
15. logo (сокр.от logotype) – **логотип, фирменный или товарный знак**
16. objective, target – **цель**
17. to submit – **представить на рассмотрение**
18. synergy – **совместная деятельность (успешная)**

Ex. 2. Match the word with the appropriate definition.

container, logistics, agent, toll, carrier, barcode

1. a person or company that represents another person or company especially in business.
2. a group of thin and thick lines printed on products you buy in a shop and which a computer can read. It contains information such as the price.
3. a company that moves goods or passengers from one place to another.
4. a large cargo-carrying standard-sized box that can be loaded from one mode of transport to another.
5. the management of materials flow through an organization, from raw materials through to finished goods.
6. the money you have to pay to use a particular road, bridge, etc.

Ex. 3. Match the words with the similar meaning.

- |                       |                    |
|-----------------------|--------------------|
| 1. benefit            | a) appreciate      |
| 2. advisor            | b) expeditor       |
| 3. objective          | c) load, cargo     |
| 4. freight            | d) association     |
| 5. freight dispatcher | e) trade mark      |
| 6. freight forward    | f) shipper         |
| 7. distribution       | g) distinguishing  |
| 8. bring forward      | h) advantage       |
| 9. distinctive        | i) realization     |
| 10. logo              | j) goal, target    |
| 11. implementation    | k) dissimilation   |
| 12. forwarder         | l) consultant      |
| 13. institute         | m) come forward    |
| 14. evaluate          | n) freight prepaid |

Ex. 4. Choose the right variant. Pay attention to the use of the word "freight".

- |                    |                                |
|--------------------|--------------------------------|
| 1. freight advance | a) условие об оплате           |
| 2. freight agent   | b) товарная узловая станция    |
| 3. freight charge  | c) грузооборот                 |
| 4. freight clause  | d) доход от грузовых перевозок |

- |                             |                                |
|-----------------------------|--------------------------------|
| 5. freight dispatcher       | e) аванс фрахта                |
| 6. freight flow             | f) обратный фрахт              |
| 7. freight home             | g) условие об оплате фрахта    |
| 8. freight-handling company | h) грузоотправитель            |
| 9. freight note             | i) грузопоток                  |
| 10. freight rate            | j) агент по фрахтовке операций |
| 11. freight receiver        | к) стоимость перевозки грузов  |
| 12. freight release         | l) грузовой парк               |
| 13. freight revenue         | m) фирма грузообработчик       |
| 14. freight terminal        | n) разрешение на выдачу груза  |
| 15. freight turnover        | o) фрахтовая ставка            |
| 16. freight yard            | p) грузополучатель             |

Ex. 5. Scan the text to give the answers to the following questions.

1. What does the abbreviation FIATA stand for?
2. What does FIATA represent today?
3. What are the main objectives of FIATA?
4. Why has FIATA created several documents and forms?
5. **There are five Advisory Bodies of FIATA, aren't they? Name them.**

Ex. 6. Read the text attentively for more information about FIATA.

**FIATA, in French "Fédération Internationale des Associations de Transitaires et Assimilés", in English "International Federation of Freight Forwarders Associations** was founded in Vienna/Austria on May 31, 1926.

FIATA, a non-governmental organisation, represents today an industry covering approximately 40,000 forwarding and logistics firms, also known as the "Architects of Transport", employing around 8-10 million people in 150 countries.

FIATA has consultative status with the Economic and Social Council (ECOSOC) of the United Nations, the United Nations Conference on Trade and Development (UNCTAD), and the UN Commission on International Trade Law (UNCITRAL).

It is recognised as representing the freight forwarding industry by many other governmental organisations, governmental authorities, private international organisations in the field of transport such as the International Chamber of Commerce (ICC), the International Road Transport Union

(IRU), the World Customs Organization (WCO), the World Trade Organization (WTO), etc.

In summary FIATA is the largest non-governmental organisation in the field of transportation. Its influence is worldwide.

#### Objectives

FIATA's main objectives are: to unite the freight forwarding industry worldwide; to represent, promote and protect the interests of the industry by participating as advisors or experts in meetings of international bodies dealing with transportation; to familiarise trade and industry and the public at large with the services rendered by freight forwarders through the dissemination of information, distribution of publications, etc.; to improve the quality of services rendered by freight forwarders by developing and promoting uniform forwarding documents, standard trading conditions, etc.; to assist with vocational training for freight forwarders, liability insurance problems, tools for electronic commerce including electronic data interchange (EDI) and barcode.

#### Congresses

Each year, FIATA holds a World Congress. This international event brings together the freight forwarding industry and transport world. It serves to conduct the business of the Federation, is a social occasion and last but not least acts as a meeting place to conduct business. Participation is between 800 - 1500 persons.

Organisation FIATA is structured into Institutes, Advisory Bodies, and Working Groups each in their turn dealing with every aspect that affects the international movement of freight.

The Institutes, which usually meet twice a year, carry out the technical work of the Federation. Currently FIATA has three, namely the Airfreight Institute (AFI); Customs Affairs Institute (CAI); Multimodal Transport Institute (MTI).

Some of the Institutes have some permanent Working Groups; e.g. the MTI has three for Sea, Rail and Road Transport, and the AFI one for IATA matters. Working Groups report to their respective Institutes and meet according to necessity.

For matters that affect the whole of the freight forwarding industry there are five Advisory Bodies:

- Advisory Body Dangerous Goods (ABDG)
- Advisory Body Information Technology (ABIT)

- Advisory Body Legal Matters (ABLM)
- Advisory Body Public Relations (ABPR)
- Advisory Body Vocational Training (ABVT)

They co-operate with the Institutes and Working Groups, if required, and meet according to necessity.

#### Regional Meetings

FIATA National Association members are divided into 4 regions worldwide. These are: Africa/Middle East, Americas, Asia/Pacific, Europe.

Each Region meets twice every year; during the HQ Session in Zurich and at the FIATA World Congress. The prime target of these regional meetings is to bring forward the specific issues of regional concern and interest, and if necessary submit them to the Institutes and Advisory Bodies of FIATA, the intention being to identify and assist regional members in solving the local difficulties. Another important topic is to gain synergies between the member countries of the regions and to import and export these benefits to other national associations.

#### Documents

FIATA has created several documents and forms to establish a uniform standard for use by freight forwarders worldwide. The documents are easily distinguishable as each has a distinctive colour and carries the FIATA logo.

- FIATA FCR (Forwarders Certificate of Receipt) - **сертификат экспедитора о получении груза**
- FIATA FCT (Forwarders Certificate of Transport) - **сертификат экспедитора о транспортировке груза**
  - FWR (FIATA Warehouse Receipt) – **складское свидетельство**
  - FBL (negotiable FIATA Multimodal Transport Bill of Lading) - **мультимодальный транспортный коносамент**
  - FWB (non-negotiable FIATA Multimodal Transport Waybill)- **необоротная мультимодальная транспортная накладная**
  - FIATA SDT (Shippers Declaration for the Transport of Dangerous Goods) - **декларация грузоотправителя о транспортировке опасных грузов**
  - FIATA SIC (Shippers Intermodal Weight Certificate) - **интермодальный весовой сертификат грузоотправителя**
  - FFI (FIATA Forwarding Instructions) – **форма экспедиторских инструкций**

FIATA documents have an excellent reputation and are recognised as documents of tradition and trust. They have greatly contributed in the past to the facilitation of international exchanges and will continue in the future to be valuable instruments in the service of world trade.

Ex. 7. Substitute the words in Russian with their appropriate equivalents in English.

1. FIATA's main (цель) is to unite (транспортно экспедиционную) industry worldwide. 2. FIATA is structured into Institutes, (консультативные органы) and working groups dealing with the international (движение грузов). 3. FIATA assists with (проблемами страховой ответственности) and electronic (обмен данными) and (штрих кодами). 4. FIATA documents are easily (отличимые) as each carries the FIATA (фирменный знак) at the head of the page. 5. The prime (цель) of the HQ Session held in Zurich twice every year is to (выдвигать) specific (вопросы) and (предоставлять на рассмотрение) them to (консультативные органы) of FIATA. 6. FIATA tries to (улучшить) the quality of services rendered by (экспедиторами) by promoting uniform (экспедиторские) documents. 7. FIATA documents are recognized as documents of tradition and (доверие) which have contributed to the (облегчение международных обменов).

Ex. 8. Fill in the blanks with the suitable prepositions.

1. FIATA represents and protects the interests .... the industry .... participating as advisors or experts .... meetings of international bodies dealing ..... transportation. 2. FIATA is structured ..... Institutes which usually meet twice per year and carry ..... the technical work of the Federation. 3. The prime target..... regional meetings is to bring ..... and submit ..... the Institutes the specific issues of regional concern and interest. 4. FIATA documents have contributed ..... the facilitation of international exchanges. 5. FIATA has consultative status ..... ECOSOC of the UN and the UN Commission ..... International Trade Law. 6. FIATA aims to familiarize trade and industry..... the services rendered ..... freight forwarders through the dissemination ..... information, distribution ..... publications.



Ex. 9. Make up questions, the answers to which are given in the right-hand column.

**What for....?**

To establish a uniform standard for use by freight forwarders worldwide

**Where and when...?**

In Zurich twice every year

**How many...?**

40 000 forwarding firms

**When and where...?**

In Vienna in 1926

**What organizations...?**

ICC, IRU, WCO

**What... for?**

Its influence is worldwide

Ex. 10. Match the right variants.

1. Y.A.R. - York-Antwerp Rules

a) по доверенности

2. w., wt. - weight

b) прошлого месяца

3. urgt. - urgent

c) ограничительная деловая практика

4. ult. - ultimate

d) вес

5. UCC - Uniform Commercial Code

e) международное депозитарное свидетельство

6. SNA - System of National Accounts

f) единый коммерческий кодекс

7. RBP - Restrictive Business Practice

g) совместное предприятие

8. per pro. - per procurationem

h) Йорк-Антверпенские правила

9. n.r.t. - net register tonnage

i) эмбарго, запрет

10. JV - Joint Venture

j) срочный

11. IDR - International Depositary Receipt

k) система национальных счетов

12. emb. - embargo

l) чистый регистровый тоннаж

Ex. 11. Translate the following sentences into Russian. Mind the use of the infinitive.

1. The aim of the advanced logistics is to decrease the costs of production and distribution. 2. The management system or the organization re-

sponsible for the business transactions within the production system and the physical distribution has to be adapted to the new concept. 3. High-quality road transport is expected to increase while general haulage will decrease. 4. The success of express transport is likely to be more dependent on the quality of the service offered than on speed. 5. Automatic vehicle identification will be used to help track vehicles and shipments. 6. The charge is expected to vary according to distance travelled, vehicle type and road type. 7. In order to reduce the extent of feeling unsafe on journeys by public transport it may be necessary to implement measures. 8. Logistics is the management of the flow of goods, information and other resources, including energy and people, between the point of origin and the point of consumption in order to meet the requirements of consumers.

Ex. 12. Translate the sentences into Russian. Mind the use of the modal verbs.

1. A balance needs to be struck between the requirements of the Customs authorities on the one hand and those of the transport operators on the other. 2. Transport is such a visible activity and such a politically sensitive one that important public policy questions. 3. Sweden has to separate companies, one for the rail infrastructure and one for the rolling stock and operations. 4. Quality programmes have to be as important in distribution as they are now for leading manufacturing companies. 5. The transport operator has to be able to predict and keep to time windows at both pick-up and delivery locations. 6. Users also can create shipment status reports and then electronically e-mail them to anyone who needs to know.

Ex. 13. Translate the sentences into Russian. Mind the use of emphatic constructions.

1. It is the aim of the Danish Road Institute that pavements cause as little noise as possible for the sake of the neighbors and yet are safe to use for the road users. 2. It is also through the physical distribution process that the time and space of customer service becomes an integral part of marketing, thus it links a marketing channel with customers. 3. It is a transport logistic system based on new transport technology that en-

sure fast and safe movement of goods at least costs. 4. It is the emergence of intermodalism that has been brought about in part by technology and requires management units for freight such as containers, swap bodies, pallets or semi-trailers. 5. It is the container that limits the risks for goods it transports because it is resistant to shocks and weather conditions.

Ex. 14. Give the main points of the text in 4-7 sentences. You may **use the following clichés:**

*The text is devoted to ... . Attention is drawn to the fact that... . It is pointed out that... . It should be noted that... . The author concludes by saying that ... . I find the text rather/very... .*

Ex. 15. Translate the following text into Russian. Use the dictionary if necessary.

*CFR - COST AND FREIGHT (... named port of destination).* "Cost and Freight" means that the seller must pay the costs and freight necessary to bring the goods to the named port of destination but the risk of loss of or damage to the goods, as well as any additional costs due to events occurring after the time the goods have been delivered on board the vessel, is transferred from the seller to the buyer when the goods pass the ship's rail in the port of shipment. The CFR term requires the seller to clear the goods for export. This term can only be used for sea and inland waterway transport. When the ship's rail serves no practical purpose, such as in the case of roll-on/roll-off or container traffic, the CPT term is more appropriate to use.

*CIF - COST, INSURANCE AND FREIGHT (... named port of destination).* "Cost, Insurance and Freight" means that the seller has the same obligations as under CFR but with the addition that he has to procure marine insurance against the buyer's risk of loss of or damage to the goods during the carriage. The seller contracts for insurance and pays the insurance premium. The buyer should note that under the CIF term the seller is only required to obtain insurance on minimum coverage. The CIF term requires the seller to clear the goods for export. This term can only be used for sea and inland waterway transport. When the

ship's rail serves no practical purposes such as in the case of roll-on/ roll-off or container traffic, the CIP term is more appropriate to use.

*FCA - FREE CARRIER (... named place)*. "Free Carrier" means that the seller fulfils his obligation to deliver when he has handed over the goods, cleared for export, into the charge of the carrier named by the buyer at the named place or point. If no precise point is indicated by the buyer, the seller may choose within the place or range stipulated where the carrier shall take the goods into his charge. When, according to commercial practice, the seller's assistance is required in making the contract with the carrier (such as in rail or air transport) the seller may act at the buyer's risk and expense. This term may be used for any mode of transport, including multimodal transport. "Carrier" means any person who, in a contract of carriage, undertakes to perform or to procure the performance of carriage by rail, road, sea, air, inland waterway or by a combination of such modes. If the buyer instructs the seller to deliver the cargo to a person, e.g. a freight forwarder who is not a "carrier", the seller is deemed to have fulfilled his obligation to deliver the goods when they are in the custody of that person. "Transport terminal", means a railway terminal, a freight station, a container terminal or yard, a multi-purpose cargo terminal or any similar receiving point. "Container" includes any equipment used to unitise cargo, e.g. all types of containers and/or flats, whether ISO accepted or not, trailers, swap bodies, ro-ro equipment, igloos, and applies to all modes of transport.

*FAS - FREE ALONGSIDE SHIP (... named port of shipment)*. "Free Alongside Ship" means that the seller fulfils his obligation to deliver when the goods have been placed alongside the vessel on the quay or in lighters at the named port of shipment. This means that the buyer has to bear all costs and risks of loss of or damage to the goods from that moment. The FAS term requires the buyer to clear the goods for export. It should not be used when the buyer cannot carry out directly or indirectly the export formalities. This term can only be used for sea or inland waterway transport.

*FOB - FREE ON BOARD (... named port of shipment)*. "Free on Board" means that the seller fulfils his obligation to deliver when the goods have passed over the ship's rail at the named port of shipment. This means that the buyer has to bear all costs and risks of loss of or

damage to the goods from that point. The FOB term requires the seller to clear the goods for export. This term can only be used for sea or inland waterway transport. When the ship's rail serves no practical purpose, such as in the case of roll-on/roll-off or container traffic, the FCA term is more appropriate to use.

## Unit Nine: TIR

---

Ex. 1. Mind the new words and expressions

1. accession – вступление, доступ
2. assessment - оценка
3. to avoid – избегать , отклонять
4. auspices-покровительство, протекция, содействие;  
(under the auspices of – при содействии, под покровительством)
5. bond – таможенная закладная
6. carnet – карнет (таможенная лицензия на проезд автомашины  
через границу )
7. contracting parties – контрагенты, договаривающиеся стороны
8. compartment – купе, отделение, отсек, камера
9. to cover – включать в себя, охватывать, относиться к ч-л
10. customs – таможенные пошлины, налог
11. delay – задержка, препятствие
12. to devise – разрабатывать
13. to dispense with - обходиться без чего либо
14. duty – налог, пошлина
15. expenses –расходы, издержки, затраты
16. facilitation – облегчение, помощь
17. frontier – граница
18. flexible - гибкий
19. impediment – преграда, препятствие
20. imposition – наложение, обложение
21. interference – вмешательство
22. to involve – включать в себя
23. issue – выпуск, публикация
24. legislation – законодательство, закон

25. load – груз, партия груза
26. maritime – морской
27. obvious – очевидный
28. provision – положение, условие ( договора)
29. revenue – доход
30. routine - стандартный, текущий
31. sine qui non – (латинск.) обязательное, неперенное условие
32. seal – печать, пломба
33. swap-body – сменный кузов для смешанных автомобильно-железнодорожных перевозок
34. to utilize – использовать, употреблять

Ex. 2. Match the word with the appropriate definition.

commerce, consignment, capacity, freight, carriage (BrE), container, costs, carnet

1. a customs license authorizing the temporary importation of a motor vehicle.
2. the amount of space a container, room etc has to hold things or people.
3. the act of moving goods from one place to another or the cost of moving them .
4. the buying and selling of goods and services.
5. an object used for or capable of holding, esp. for transport or storage, such as a carton, box, etc .
6. a quantity of goods that are sent somewhere, especially in order to be sold.
7. the money that you must regularly spend in order to run a business, a home, a car.
8. goods that are carried by ship, train or aircraft and the system of moving these goods.

Ex. 3. Match the words and word combinations with the similar meaning.

1) customs

a) costs

- 2) impediment
- 3) auspices
- 4) accession
- 5) expenses
- 6) legislation
- 7) facilitation
- 8) frontier
- 9) obvious
- 10) to utilize
- 11) to cover
- 12) to devise

- b) help, aid
- c) formulate, invent
- d) protection
- e) law
- f) toll, duty
- g) obstacle
- h) admission
- i) evident
- j) to include
- k) to use
- l) boundary

Ex. 4. Choose the right variant for each word combination.

- |  |  |
|--|--|
| 1) swap body                           | a) <b>наложение требований безопасности</b>  |
| 2) imposition of security requirements | b) <b>морской транспорт</b>                  |
| 3) a sine qua non                      | c) <b>непременное условие</b>                |
| 4) contracting parties                 | d) <b>национальное законодательство</b>      |
| 5) maritime transport                  | e) <b>единый транспортный документ</b>       |
| 6) secure loading unit                 | f) <b>оценка риска</b>                       |
| 7) inland container                    | g) <b>процедура пересечения границы</b>      |
| 8) international movement of goods     | h) <b>безопасный грузовой отсек</b>          |
| 9) transit regime                      | i) <b>внутренний контейнер</b>               |
| 10) border crossing procedures         | j) <b>проверка груза</b>                     |
| 11) load compartment                   | k) <b>сменный контейнер</b>                  |
| 12) single transit document            | l) <b>международное передвижение товаров</b> |
| 13) national legislation               | m) <b>контрагенты</b>                        |
| 14) risk assessment                    | n) <b>грузовой отсек</b>                     |
| 15) inspection of load                 | o) <b>транзитный режим</b>                   |

Ex. 5. Choose the right variant for each word combination. Mind the meaning of the word **‘customs’**.

- |                             |   |
|-----------------------------|---|
| 1) customs duties           | a) квитанция таможи об уплате пошлины               |
| 2) customs official         | b) уплата таможенной пошлины                        |
| 3) customs revenue          | c) очистка от таможенных пошлин; таможенный досмотр |
| 4) customs declaration      | d) импортная таможенная стоимость                   |
| 5) customs supervision      | e) таможенные пошлины                               |
| 6) customs facilities       | f) таможенные льготы                                |
| 7) customs tariff           | g) таможенная декларация                            |
| 8) customs clearance charge | h) таможенный досмотр                               |
| 9) customs receipt          | i) таможенная заявка                                |
| 10) customs clearance       | j) таможенные денежные поступления                  |
| 11) customs seal            | k) таможенная печать, таможенная пломба             |
| 12) customs application     | l) таможенная стоимость                             |
| 13) customs survey          | m) таможенный инспектор; представитель таможи       |
| 14) customs import value    | n) таможенный тариф                                 |
| 15) customs value           | o) таможенный контроль                              |

Ex. 6. Look at the headline of the article and try to guess what information it contains. Skim the article to check your guess.

Ex. 7. Read the article attentively for more detailed information about the TIR Customs transit system.

The TIR Convention of 1975 came into force in 1978. Since that time the TIR Convention has proved that it is one of the most successful international transport conventions and is in fact the only universal Customs transit system in existence. The idea behind the TIR Convention and its transit regime has formed the basis for many regional transit systems and has thus, directly and indirectly, contributed to the facilitation of international transport, especially international road transport, not on-



ly in Europe and the Middle East, but also in other parts of the world, such as Africa and Latin America.

Anyone who has ever traveled on European roads will recognize the familiar blue and white TIR plate borne by thousands of lorries and semi-trailers using the TIR Customs transit system. For the driver, the transport operator and the shipper, this plate stands for fast and efficient international transportation by road.

Work on the TIR transit system started soon after the Second World War. The first TIR Agreement was concluded in 1949 between a small number of European countries.

The experience gained in the first 10 to 15 years of operating the system was thus used to make the TIR system more efficient, less complex and at the same time more Customs secure. Another reason why the original TIR system had to be modified was that in the early 1960's a new transport technique emerged: the maritime container. It was followed a little later by the inland container used by the European railways and by the swap-body introduced for improving the efficiency of road/rail transport.

These new combined or multimodal transport techniques necessitated the acceptance of the container, under certain conditions, as a Customs secure loading unit. It meant also that TIR regime no longer only covered road transport, but was extended to rail, inland waterways and even maritime transport, although at least one part of the total transport operation still has to be made by road.

The advantages of the TIR Convention to commerce and transport interests are obvious. Goods may travel across national frontiers with a minimum of interference by Customs administrations. By easing traditional impediments to the international movement of goods, the TIR system encourages the development of international trade. By reducing delays in transit, it enables significant economies to be made in transport costs.

The TIR Convention has proved to be one of the most effective international instruments prepared under the auspices of the United Nations Economic Commission for Europe (UNECE). To date, it has 65 Contracting Parties, including the European Community. It covers the whole of Europe and reaches out to North Africa and the Near and Middle East. Countries in Asia have been informed about the facilities of this global Customs transit system and their interest has shown that they may well join the TIR Convention in the not too distant future. Already today, the

United States of America and Canada are Contracting Parties as well as Chile and Uruguay in South America.

The success of the TIR system may also be judged by the number of TIR Carnets distributed and issued every year.

As a result of the expanding East-West European trade, corresponding tremendous increase in international road transport, the number of TIR Carnets issued has now reached 3.2 million (2004) which represents the start of nearly 10,000 TIR transports every day in more than 50 countries and well over 50,000 TIR border crossing procedures daily.

The accession of a number of Central European countries to the European Community in 2004 may lead to a decrease in the number of TIR transport operations in this part of Europe, as, TIR Carnets cannot be used for Customs transit operations within the member countries. But the development may well be compensated by an increase in TIR transport operations in and to the countries of the Middle East and Asia.

The tremendous increase in the use of the TIR Customs transit system can be explained by the special features of the TIR regime which offer transport operators and Customs authorities a simple, flexible, cost-effective and secure Customs regime for the international transport of goods across frontiers.

The TIR Convention also provides, through its international guarantee chain, relatively simple access to the required guarantees which are a sine qua non (necessary conditions) for the transport and trade industry to benefit from the facilities of Customs transit systems.

Finally, in reducing the impediments to international traffic by road caused by Customs controls, it enables exporters and importers to select more easily the form of transport most suitable for their needs.

Traditionally when goods crossed the territory of one or more States in the course of an international transport of goods by road, the Customs authorities in each state applied national controls and procedures. These varied from State to State, but frequently involved the inspection of the load at each national frontier and the imposition of national security requirements (guarantee, bond, deposit of duty, etc.) to cover the potential duties and taxes at risk while the goods were in transit through each territory. These measures, applied in each country of transit, led to considerable expenses, delays and interferences with international transport.

In an attempt to reduce these difficulties experienced by transport operators and, at the same time, to offer Customs administrations an international system of control replacing traditional national procedures, whilst effectively protecting the revenue of each State through which goods were carried, the TIR system was devised.

As regards Customs control measures at frontiers, the TIR system clearly has advantages for Customs administrations as it reduces the normal requirements of national transit procedures. At the same time the system avoids the need - expensive in manpower and facilities - for physical inspection in countries of transit other than checking seals and the external conditions of the load compartment or container. It also dispenses with the need to operate national guarantees and national systems of documentation.

In addition, advantages arise from the fact that the international transit operation is covered by a single transit document, the TIR Carnet, which reduces the risk of presenting inaccurate information to Customs administrations.

In case of doubt, Customs authorities have the right to inspect the goods under Customs seal at any time and, if necessary, to interrupt the TIR transport and/or to take adequate measures in accordance with national legislation. In view of the strict provisions of the TIR Convention and the interest of all Customs authorities and transport operators to apply these provisions, such interventions should remain exceptional. Customs authorities can therefore reduce routine administrative Customs procedures to a minimum and devote their limited resources to specific control measures based on risk assessment and intelligence information.

Ex. 8. Provide the answers to the questions given below.

1. What has the TIR Convention contributed to?
2. What does blue and white TIR plate stand for?
3. What is the main aim of TIR system?
4. What are the advantages of TIR to commerce and transport?
5. What countries are the members of TIR Convention?
6. How can the increase in the use of the TIR Customs transit system be explained?
7. What measures led to considerable expenses, delays and interferences with international transport?

8. Why was the TIR system devised?
9. What are the advantages of TIR Carnet?
10. What rights do Customs authorities have?

Ex. 9. Substitute the words in Russian with their appropriate equivalents in English.

1. **(В случае сомнения)** Customs authorities have the right to inspect the **(товары)** under Customs **(таможенная пломба)** at any time and, if necessary **(принимать соответствующие меры)** in accordance with national **(законодательство)**. 2. **(Таможенные)** procedures involve the inspection of the **(груз)** at each national **(граница)** and the imposition of national **(требования безопасности)**, guarantee, **(таможенная накладная)**, **(депозитная пошлина)**, etc. to cover duties and taxes at risk. 3. National controls and procedures applied by **(таможенные власти)** in each country of transit led to **(значительные расходы)**, **(задержки)** and **(вмешательство)** with international transport. 4. **(Что касается)** Customs control measures at frontiers, the TIR system **(избегает)** the need for physical inspection in countries of transit other than **(проверка пломб)** and the **(внешних)** conditions of the **(грузовой вагон)** or container. 5. **(Товары)** may travel across national **(границы)** with a minimum of **(вмешательство)** by **(таможенный)** administrations. 6. In reducing the **(препятствий)** to international traffic by road caused by Customs controls the TIR Convention provides relatively simple **(доступ)** to the required guarantees which are **(необходимые условия)** for the transport and trade industry. 7. Customs authorities can **(уменьшить)** routine administrative **(таможенные процедуры)** and **(посвятить)** their resources to specific control measures based on **(оценке риска)** and intelligence information.

Ex. 10. Fill in the blanks with the prepositions.

1. The TIR Convention provides ... its international guarantee chain access ... the guarantees ... the transport. 2. Goods may travel ... national frontiers ... a minimum of interference ... Customs administrations. 3. The TIR Convention is one of the most effective international instruments prepared ... the auspices of the United Nations Economic Commission ... Europe (UNECE). 4. The TIR system encourages the development of international trade ... reducing delays in transit. 5. The

TIR Convention came ... force in 1978. 6. Customs authorities have the right to inspect the goods ... Customs seal at any time and to take adequate measures ... national legislation. 7. TIR Carnets cannot be used ... Customs transit operations ... its member countries. 8. As regards Customs control measures ... frontiers, the TIR system reduces the normal requirements ... national transit procedures. 9. These new multimodal transport techniques necessitated the acceptance ... the container... certain conditions, as a Customs secure loading unit.

Ex. 11. Translate the following sentences into Russian. Mind the use of the verb to be.

1. Efficiently operating transport networks in the former segmented European space-economy are critical success factors for the competitive edge of Europe. 2. Competitive efficiency is in the centre of current European transport policy. 3. There is a major more recent policy concern on the question whether transport will be devastating for environmentally sustainable development. 4. The purpose of production logistics is to ensure that each machine and workstation is being fed with the right product in the right quantity and quality at the right point of time. 5. One of the keys to the success of the container is that an agreement about its base dimensions and latching system was reached through the International Standards Organization (ISO) within 10 years of its introduction.

Ex. 12. Translate the following sentences into Russian. Mind the use of the passive voice.

1. Since 90% of all traffic information is perceived visually, special attention must be paid to the visibility of traffic signs and systems. 2. Domestic road transport is being deregulated in most European countries. 3. Transport of goods by road is still hampered by restrictions on cabotage, empty runs and a lack of fiscal, technical and social harmonization. 4. Entrepreneurs offering transport services are being encouraged to develop door-to-door delivery systems which implies finding the ultimate balance between the existing transport modes. 5. Transport is affected by international economic shifts, by tourism and by changes in the balance of trade with Europe. 6. Road infrastructure costs have been closely examined in the UK over many years. 7. Changes in the supply of transport

services are affected by men technologies, customer demand and external cost.

Ex. 13. Give the main points of the text in 4-6 sentences. You may **use the following clichés:**

*The text deals with... . The author points out that... . Attention is drawn to the fact that... . It is pointed out that... . It should be noted that... . The author comes to the conclusion that... . I find the text rather/very... .*

Ex. 14. Translate the text into Russian. Use the dictionary if necessary.

The TIR Customs Convention, through its familiar symbol on the backs of vehicles, has become known to every man, woman and child who has travelled the highways of Europe over the past few decades.

"TIR" stands for Transports Internationaux Routiers as defined in the UNECE TIR Convention.

The TIR system has been devised to facilitate to the maximum extent the international movement of goods under Customs seals. The system provides transit countries with the required guarantees to cover the Customs duties and taxes at risk. A balance is struck between the responsibilities of the Customs authorities and those of the international trading community.

The TIR system offers the following benefits to the different stakeholders involved in the international movement of transit goods:

- Facilitation of transport and trade reduces transport costs by reducing formalities and delays in transit; facilitates transit movements by the application of standardized controls and documentation; and as a result, encourages the development of international trade.

- For the transport industry goods move across international frontiers with minimum interference; delays and costs of transit are reduced; documents are simplified and standardised; and there is no need to make Customs guarantee deposits at transit borders.

- For Customs authorities duties and taxes at risk during international transit movements are guaranteed up to USD 50,000; only bona fide conscientious transport operators are permitted to use TIR carnets, thus increasing the security of the system; the need for physical inspection of goods in transit is reduced; the system facilitates Customs control

and documentation; and use of internal clearance points for export and import allows more efficient deployment of Customs personnel.

However, as regards goods in transit, a way had to be found to seal the goods in order to apply the transit bond-note system to transport operations and to enable the Customs formalities applicable to imported goods to take place at destination rather than at the border.

The TIR system is an international Customs transit system for goods carried by road. It is based on 5 essential principles – the 5 pillars of the TIR system.

1. Secure vehicles or containers: goods are carried in sealed vehicles or containers which are approved for use by Customs and re-approved every two years.

2. International chain of guarantee: duties and taxes due in case of irregularity are secured by an international guarantee chain throughout the journey.

3. TIR carnet: the goods are accompanied by the TIR carnet: a control document accepted by the Customs authorities of the countries of departure, transit and destination.

4. Mutual recognition of Customs controls: control measures taken in the country of departure are accepted by countries of transit and destination.

5. Controlled access: access to the TIR system for national issuing and guaranteeing associations is given by the competent national authorities, and for transport operators, by the National Customs authorities and the National Association.

## Unit Ten: Containerization

---

---

Ex. 1. Mind the new words and expressions.

1. to abandon - **отказываться**
2. approximate – **приблизительный**
3. to allow for - **учитывать**
4. bale – **тюк, пакет**
5. barrel – **бочка; баррель (мера жидких, сыпучих и некоторых твёрдых материалов)**

6. bulk – масса; большое количество (крупная партия груза, без какой-л. упаковки; напр., зерно, уголь)
7. to boost – поддерживать, форсировать
8. bolster - поддон
9. collapsible - складной; раздвижной
10. compatibility - совместимость; соответствие
11. crate - (деревянный) ящик; тара для упаковки
12. drum – барабан, цилиндрический контейнер, металлическая бочка
13. gauge - мера, размер
14. to handle –трансп.: производить транспортную обработку (грузов)
15. intact – неповрежденный, нетронутый
16. imperial measures (measurements) - имперские меры (стандартные единицы мер, принятые в Соединённом Королевстве )
17. overwhelming – огромный, ошеломляющий
18. pallet - (грузовой) поддон для перевозки грузов
19. payload - грузоподъёмность; полезная нагрузка; трансп. коммерческая нагрузка (груз, который транспортируется за плату)
20. to plague –беспокоить, досаждать
21. to recycle – перерабатывать
22. reefer – рефрижератор, вагон- холодильник
23. to result from – происходить вследствие, являться результатом
24. to result in - приводить к
25. to salvage -собирать и использовать утильсырьё
26. scrutiny - внимательный осмотр
27. to seal - опечатывать
28. semi-finished goods – полуфабрикаты
29. to smuggle contraband - провозить контрабандой
30. to stack- -накапливать, укладывать в штабеля
31. swap body – съёмный (сменный) кузов для смешанных автомобильно-железнодорожных перевозок
32. tampering - 1) фальсификация; подделка 2) манипуляции, подкуп

Ex. 2. Mind the following abbreviations.

1. ISO - International Organization for Standardization ИСО – Международная Организация по Стандартизации



2. ITU - Intermodal Transport Units – единицы (контейнеры) для смешанных перевозок
3. TEU - twenty-foot equivalent units – единицы, эквивалентные 20 футам
4. FEU - forty-foot equivalent unit - единицы, эквивалентные 40 футам

Ex. 3. Match the word with the appropriate definition.

Intermodal, cargo, truck, cost, container, pallet.

1. the price paid or required for acquiring, producing, or maintaining something, usually measured in money, time, or energy; expense or expenditure; outlay.
2. a large motor vehicle designed to carry heavy loads, esp. one with a flat platform .
3. a standard-sized platform of box section open at two ends on which goods may be stacked. The open ends allow the entry of the forks of a lifting truck so that the palletized load can be raised and moved about easily.
4. using different modes of conveyance in conjunction, such as ships, aircraft, road vehicles, etc.
5. goods carried by a ship, aircraft, or other vehicle; freight.
6. an object used for or capable of holding, esp. for transport or storage, such as a carton, box, etc.

Ex. 4. Choose the right variant for each word combination. Mind the **right translation of the word “bulk”**.

- |                              |  |
|------------------------------|--|
| a) break bulk                | 1) прекращение погрузки товара навалом |
| b) break of bulk             | 2) оптовый покупатель                  |
| n) the bulk of goods on sale | 14) бестарный груз                     |
| d) bulk buyer                | 4) большая часть груза                 |
| e) bulk cargo                | 5) разбивать крупную партию на мелкие  |
| f) bulk discount             | 6) скидка с объема за количество       |
| g) bulk of the cargo         | 7) грузить без упаковки                |

- |                  |  |
|------------------|--|
| h) bulk rate     | 8) фрахтовая ставка для перевозки большой партии груза |
| i) bulk storage  | 9) поставка крупными партиями                          |
| j) bulk supplies | 10) оптом, большими партиями                           |
| k) bulk supply   | 11) предметы снабжения, поступающие крупными партиями  |
| l) in bulk       | 12) большая часть товаров, имеющихся в продаже         |
| m) load in bulk  | 13) бестарное хранение, хранение навалом               |

Ex. 5. Choose the right variant for each word combination. Mind the translation **of the word "container"**.

- |                       |  |
|-----------------------|--|
| a) cargo container    | 1) кран для перегрузки контейнеров   |
| b) container crane    | 2) большой грузовой поезд, составленный из вагонов, созданных специально для транспортировки контейнеров |
| c) container depot    | 3) контейнеровоз, контейнерное судно   |
| d) container ship     | 4) контейнерный склад  |
| e) container traffic  | 5) дорога/путь, сделанные для транспортировки контейнеров  |
| f) container train    | 6) грузовой контейнер  |
| g) container truck    | 7) контейнерная перевозка  |
| h) transcontainer     | 8) контейнер, "специализирующийся" на перевозке только тех или иных товаров                              |
| i) container capacity | 9) контейнерные перевозки  |
| j) container cargo    | 10) объём контейнера   |
| k) container loader   | 11) контейнерный груз  |
| l) container shipment | 12) погрузчик контейнеров  |

Ex. 6. Read the text and say what you have learnt about the containerization.

Containerization is a system of intermodal freight transport cargo transport using standard ISO containers (known as shipping containers), ITUs (Intermodal Transport Units) that can be loaded and sealed intact onto container ships, railroad cars, planes, and trucks.

Although having its origins in the late 1780s or earlier, the global standardization of containers and container handling equipment was one of the important innovations in 20th century logistics.

Toward the end of World War II, the United States Army began using specialized containers to speed up the loading and unloading of transport ships. After the U.S. Department of Defense standardized an 8'x8' cross section container in multiples of 10' lengths for military use it was rapidly adopted for shipping purposes. These standards were adopted in the United Kingdom for containers and rapidly displaced the older wooden containers in the 1950s.

Even the railways of the USSR had their own small containers. The introduction of containers resulted in vast improvements in port handling efficiency, thus lowering costs and helping lower freight charges and, in turn, boosting trade flows. Almost every manufactured product spends some time in a container.

Containerization has revolutionized cargo shipping. Today, approximately 90% of non-bulk cargo worldwide moves by containers stacked on transport ships; 26% of all containers originate from China.

The widespread use of ISO standard containers has driven modifications in other freight-moving standards, gradually forcing removable truck bodies or swap bodies into the standard sizes and shapes (though without the strength needed to be stacked), and changing completely the worldwide use of freight pallets that fit into ISO containers or into commercial vehicles.

Improved cargo security is also an important benefit of containerization. The cargo is not visible to the casual viewer and thus is less likely to be stolen and the doors of the containers are generally sealed so that tampering is more evident. This has reduced the "falling off the truck" syndrome that long plagued the shipping industry.

Container capacity is often expressed in twenty-foot equivalent units (TEU, or sometimes teu). An equivalent unit is a measure of containerized cargo capacity equal to one standard 20 ft (length) × 8 ft (width) container. As this is an approximate measure, the height of the box is not considered. Similarly, the 45-ft (13.7 m) containers are also commonly designated as two TEU, although they are 45 and not 40 feet (12 m) long. Two TEU are equivalent to one forty-foot equivalent unit (FEU).

The use of Imperial measurements to describe container size (TEU, FEU) reflects the fact that US Department of Defense played a major part in the development of containers. The overwhelming need to have a standard size for containers, in order that they fit all ships, cranes, and trucks, and the length of time that the current container sizes have been in use, makes changing to an even metric size impractical.

The maximum gross mass for a 20 ft (6.1 m) dry cargo container is 24,000 kg. Allowing for the tare mass of the container, the maximum payload mass is therefore reduced to approximately 21,600 kg for 20 ft (6.1 m),

Since November 2007 48-ft and 53 ft (16 m) containers are used also for international ocean shipments. Various container types are available for different needs:

- -General purpose dry van for boxes, cartons, cases, sacks, bales, pallets, drums in standard, high or half height;
- -High cube palletwide containers for europallet compatibility;
- -**Temperature controlled from -25 °C to +25 °C reefer**;
- -Open top bulkainers for bulk minerals, heavy machinery;
- -Open side for loading oversize pallet;
- -Flushfolding flat-rack containers for heavy and bulky semi-finished goods, out of gauge cargo;
- -Platform or bolster for barrels and drums, crates, cable drums, out of gauge cargo, machinery, and processed timber;
- -Ventilated containers for organic products requiring ventilation;
- -Tank containers for bulk liquids and dangerous goods;
- -Rolling floor for difficult to handle cargo;
- -Gas bottle;
- -Generator;
- -Collapsible ISO;
- -Swap body.

Containers have been used to smuggle contraband. The vast majority of containers are never subjected to scrutiny due to the large number of containers in use. In recent years there have been increased concerns that containers might be used to transport terrorists or terrorist materials into a country undetected. The U.S. government has advanced the Container Security Initiative (CSI), intended to ensure that high-risk cargo is examined or scanned, preferably at the port of departure.

Containers are intended to be used constantly, being loaded with a new cargo for a new destination soon after being emptied of the previous cargo. This is not always possible, and in some cases the cost of transporting an empty container to a place where it can be used is considered to be higher than the worth of the used container. This can result in large areas in ports and warehouses being occupied by empty containers left abandoned. However, empty containers may also be recycled in the form of shipping container architecture, or the steel content salvaged.

Ex. 7. Provide answers to the questions below.

1. What does the containerization mean?
2. When were the standards for containers adopted in the United Kingdom and in the USA?
3. **Containerization has revolutionized cargo shipping, hasn't it?**
4. What is considered to be one of the important benefits of containerization?
5. How is container capacity often expressed?
6. What are the general types of container?
7. Is there any misuse of containers?

Ex. 8. Translate the following word combination into Russian. Use the dictionary if necessary. Consult the text.

intermodal freight transport  
container handling equipment  
handling efficiency  
payload mass  
boosting trade flows  
flushfolding flat-rack containers

out of gauge cargo  
cross section container  
freight charges  
tare mass  
dangerous goods  
open side for loading

Ex. 9. Replace the words in Russian with their appropriate equivalents in English.

1. Containers have been used to (**провозить контрабанду**). 2. The introduction of containers resulted in vast improvements in (**эффективность обработки грузов в порту**), thus lowering costs and helping lower (**расходы по перевозке**) and, in turn, (**поддержка торговых потоков**). 3. Containerization has revolutionized (**грузоперевозки**). 4. The use of (**стандартные единицы**) to describe container (**размер**) reflects the fact that US Department of Defense played a major part in the (**разработка**) of containers. 6. The (**груз**) is not visible to the casual viewer and thus is less likely to be stolen and the doors of the containers are generally sealed so that (**фальсификация**) is more (**очевидна**). 7. Platform or (**поддон**) for barrels and drums, (**деревянные ящики**), cable drums, out of gauge (**груз**), machinery, and processed timber is a type of container. 8. The widespread use of ISO standard containers has changed (**съёмные кузова**) into the standard sizes and shapes and changed completely the worldwide use of freight (**поддоны**) that fit into ISO containers or into commercial vehicles. 9. (**Учитывая**) the tare mass of the container, the maximum (**полезная нагрузка**) mass is therefore (**уменьшены**). 10. (**Пустые**) containers may be (**переработаны**) in the form of (**транспортный контейнер**) architecture, or the steel content (**утилизировано**).

Ex. 10. Fill in the blanks with the appropriate prepositions.

1. Various container types are available ... different needs. 2. Today, approximately 90% ... non-bulk cargo worldwide moves ... containers stacked ... transport ships; 26% of all containers originate ... China. 3. Tank containers are intended ... bulk liquids and dangerous goods. 4. This can result ... large areas in ports being occupied ... empty containers left abandoned. 5. The introduction of containers resulted ... vast improvements in port handling efficiency. 6. The vast majority ... containers are never subjected ... scrutiny due ... the large number of containers ... use.

Ex. 11. Match the words and word combinations with the similar meaning.

- |                |                           |
|----------------|---------------------------|
| a) to displace | 1) expenses               |
| b) to abandon  | 2) lorry                  |
| c) shipping    | 3) to decrease            |
| d) swap body   | 4) transportation         |
| e) evident     | 5) to refuse              |
| f) to reduce   | 6) removable truck bodies |
| g) gauge       | 7) obvious                |
| h) cargo       | 8) load                   |
| i) truck       | 9) to remove              |
| j) costs       | 10) measure               |

Ex. 12. Translate the sentences into Russian, paying attention to the participial constructions.

1. Logistics creates time and space utility for the products being moved, thereby enabling the logistics users to provide value-added to their customers. 2. Services using advanced logistics always demand reliability but not necessarily speed. 3. Incidents or near collisions with other vehicles or objects, or driving off the road are not unusual when mobile phones are used while driving. 4. Although the deterioration of transport varies depending on time and place and the type and mode of transport, it is a general phenomenon. 5. Now many companies have started constructing logistics systems, introducing leading logistics strategies and technologies. 6. One of the main measures considered by logistics managers of agro industries with continuous process is related to truck waiting times in the reception area. 7. Transport services provided in return for money can immediately be classed as third-party operations. 8. The investigation carried out is based on the data from the road surface measurements made on stale roads and accidents reported by the police.

Ex. 13. Translate the sentences into Russian, paying attention to the infinitive.

1. The objective will be to maintain a high service level based on the reliability of supply. 2. The TIR Convention has proved to be one of the most effective international instruments prepared by the United Nations Economic Commission for Europe. 3. In order to stabilize the TIR system in the long term, more profound modifications in its operation and in the governmental cooperation and control mechanisms were felt to be

required. 4. By reducing delays in transit, TIR system enables significant economics to be made in transport costs. 5. When transport regulations were first introduced the aim was to protect the railways. 6. Driver fatigue or falling asleep is recognized to be among the most important causative factors in road crashes, next to alcohol, speeding and inattention. 7. Buses are believed to be potentially flexible and cost effective method of public transport offering many advantages over rail. 8. The current ongoing deregulation of international road transport is expected to increase the load factors of vehicles considerably and thereby reduce the total transport cost. 9. The speed of delivery required this is conjunction with the type of cargo and its transport logistics characteristics may well determine the mode as well as the route to be taken.

Ex. 14. Translate the sentences into Russian, paying attention to the conjunctions and compound prepositions.

1. Intermodal transport is the carriage of goods by several modes of transport from one point/port of origin via one or more interface points to a final port/point where one of the carriers organizes the whole transport. 2. Such problem solution allows managers to optimize the transport channel more operatively and effectively both in terms of cost (rates) and time. 3. This may be due to economic factors and hence inadequate networks and services, or poor accessibility. 4. Because of the much higher densities of people and activities, environmental, economic, public health, social and quality of life considerations and constraints are important in cities. 5. Supply chain planning is carried out at corporate level as well as at operation level. 6. Supply chain management is significant for both service and manufacturing organizations, although the complexity of the chain may vary greatly from industry to industry. 7. A supply chain network of an organization includes the location as well as movement decisions in respect of procurement of raw materials and other inputs, transformation of these materials into intermediate and finished products and the distribution of these finished products to customers.

Ex. 15. Give the main points of the text in 4-7 sentences. Use the following clichés:



*The text deals with... . The author points out that... . Attention is drawn to the fact that... . It is pointed out that... . It should be noted that... . The author comes to the conclusion that... . I find the text rather/very... .*

Ex. 16. Translate the following text into Russian. Use the dictionary if necessary.

Transport is a key factor in modern economies. However, there is a permanent contradiction between society, which demands ever more mobility, and public opinion, which is becoming increasingly intolerant of chronic delays and the poor quality of some transport services. As **demand for transport keeps increasing, the Community's answer cannot** be just to build new infrastructure and open up markets. The transport system needs to be optimised to meet the demands of enlargement and sustainable development, as set out in the conclusions of the Gothenburg European Council. A modern transport system must be sustainable from an economic and social as well as an environmental viewpoint. Plans for the future of the transport sector must take account of its economic importance. The sector employs more than 10 million people. It involves infrastructure and technologies whose cost to society is such that there must be no errors of judgment. Indeed, it is because of the scale of investment in transport and its determining role in economic growth that the authors of the Treaty of Rome made provision for a common transport policy with its own specific rules. For a long time, the European Community was unable, or unwilling, to implement the common transport policy provided for by the Treaty of Rome. For nearly 30 years the **Council of Ministers was unable to translate the Commission's proposals** into action. It was only in 1985, when the Court of Justice ruled that the Council had failed to act, that the Member States had to accept that the Community could legislate. Later on, the Treaty of Maastricht reinforced the political, institutional and budgetary foundations for transport policy.

Europe must bring about a real change in the Common Transport Policy. The time has come to set new objectives for it: restoring the balance between modes of transport and developing intermodality, combating congestion and putting safety and the quality of services at the heart of our efforts, while maintaining the right to mobility. One of the main challenges is to define common principles for fair charging for the dif-

ferent modes of transport. This new framework for charging should both promote the use of less polluting modes and less congested networks and prepare the way for new types of infrastructure financing.

## Unit Eleven: The Spatial Economy of Road Transportation

---

---

Ex. 1. Mind the new words and expressions.

1. acute- **острый, крайний, критический**
2. attribute – **показатель, характеристика**
3. to constrain – **ограничивать, сдерживать**
4. convergence – **схождение в одной точке, сближение**
5. custodian - **хранитель, смотритель**
6. disparity – **различия; несоответствие**
7. divergence – **расхождение, отклонение**
8. economies of scale (scale economies) - **экономия, обусловленная ростом масштабов производства; положительный эффект масштаба**
9. to expropriate – **лишать собственности, отчуждать**
10. externalities - **вид, внешность, облик, проявления**
11. to impose – **налагать, устанавливать**
12. mandatory – **обязательный, принудительный**
13. obstacle – **препятствие, затруднение, помеха**
14. perishables - **скоропортящиеся грузы; скоропортящиеся товары**
15. restriction- **ограничение, помеха**
16. slope – **уклон, наклон**
17. spatial - **пространственный**
18. sustainable – **устойчивый (экологически)**
19. traction - **сила тяги; сцепление**
20. trucking industry - **грузоперевозки**
21. trunk - **магистраль; главная линия**
22. vested - **законный, принадлежащий по праву**

Ex. 2. Match the word with the appropriate definition.

consumption, impose, externality, goods, demand, vested, infrastructure

1. commodities that are tangible, usually movable, and generally not consumed at the same time as they are produced;
2. to establish as something to be obeyed or complied with; enforce to
3. willingness and ability to purchase goods and services
4. economics expenditure on goods and services for final personal use
5. the stock of fixed capital equipment in a country, including factories, roads, schools, etc., considered as a determinant of economic growth
6. having a present right to the immediate or future possession and enjoyment of property
7. an economic effect that results from an economic choice but is not reflected in market prices

Ex. 3 Match the words and word combinations with the similar meaning.

- |                 |                   |
|-----------------|-------------------|
| 1) restrictions | a) influence      |
| 2) growth       | b) lessening      |
| 3) costly       | c) limitation     |
| 4) income       | d) structure      |
| 5) impact       | e) limitations    |
| 6) consumption  | f) expensive      |
| 7) construction | g) increase       |
| 8) restriction  | h) use            |
| 9) attribute    | i) revenue        |
| 10) reduction   | j) characteristic |

Ex. 4. Choose the right variant for each word combination.

- |                                     |                                     |
|-------------------------------------|-------------------------------------|
| 1) under such circumstances         | a) городская окружающая среда       |
| 2) multiplication of road accidents | b) городская многорядная автострада |
| 3) size constraints                 | c) расхождение в ценах              |
| 4) geographical disparities         | d) увеличение ДТП                   |
| 5) market dominance                 | e) грузоподъемность                 |
| 6) individual vehicle ownership     | f) ограничение по размерам          |
| 7) carrying capacity                | g) гравийная дорога                 |
| 8) divergence of costs              | h) платная дорога                   |
| 9) multi-lane urban expressway      | i) мощность тягового уси-           |

- |                             |  |
|-----------------------------|--|
| 10) gravel road             | лия(сила сцепления)                              |
| 11) door to door service    | j) служба от места отправления до места прибытия |
| 12) toll road               | k) законные интересы                             |
| 13) right of passage        | l) доминирование на рынке                        |
| 14) urban environment       | m) право на проезд                               |
| 15) sustainable environment | n) географические различия                       |
| 16) vested interests        | o) грузоперевозки                                |
| 17) traction capacities     | p) автомобиль в личной собственности             |
| 18) trucking industry       | q) устойчивая окружающая среда                   |
|                             | г) при таких обстоятельствах                     |

Ex. 5. Choose the right variant for each word combination. Mind the use of some economic terms:

- |  |   |
|--|---|
| 1) economy of scale                    | a) внешние издержки   |
| 2) administration costs                | b) издержки на отчуждение                                       |
| 3) development costs                   | с) экономика, обусловленная ростом масштаба производства        |
| 4) environmental externality           | d) расходы по содержанию административного аппарата             |
| 5) construction costs                  | e) издержки на разработку                                       |
| 6) expropriation costs                 | f) страховые сборы  |
| 7) maintenance costs                   | g) развитые и развивающиеся страны                              |
| 8) external costs                      | h) эксплуатационные расходы                                     |
| 9) insurance fees                      | i) затраты на строительство                                     |
| 10) inventory                          | j) ущерб, причиняемый в результате воздействия окружающей среду |
| 11) developed and developing countries | k) материально-производственные запасы                          |

Ex. 6. Read the text and say what you have learnt about the spatial economy of road transportation.

Road transportation is the mode that has expanded the most over the last 50 years, both for passengers and freight transportation. Such growth in road freight transport has been fuelled largely by trade liberalization. This is the result of growth of the loading capacity of vehicle and an adaptation of vehicle to freight (e.g. perishables, fuel, construction materials, etc) or passengers (e.g. school bus) demand for speed, autonomy and flexibility. New types of problems, such as a significant growth of fuel consumption, increasing environmental externalities, traffic congestion and a multiplication of road accidents have emerged.

Road infrastructures are moderately expensive to provide, but there is a wide divergence of costs, from a gravel road to a multi-lane urban expressway. Because vehicles have the means to climb moderate slopes, physical obstacles are less important than for some other land modes. Most roads are provided as a public good by governments, while the vast majority of vehicles are owned privately. The capital costs, therefore, are shared, and do not fall as heavily on one source as is the case for other modes. However, in many cases, governments have been inefficient custodians of road infrastructure. Consequently, a growing number of roads have been privatized and companies specializing in road management have emerged, particularly in Europe and North America. This is only possible on specific trunks that have an important and stable traffic. Unlike governments, private enterprises have vested interests to see that the road segments they manage are maintained and improved since the quality of the road will be directly linked with revenue generation. The majority of toll roads are highways linking large cities or bridges and tunnels where there is a convergence of traffic. Most roads are not economically profitable but must be socially present as they are essential to service populations.

Governments can expropriate the necessary land for road construction since a private enterprise may have difficulties to expropriate without government support. Another important aspect about roads is their economies of scale and their indivisibility, underlining that the construction and maintenance of roads is cheaper when the system is extensive, but to a limit. However, all road transport modes have limited abilities to achieve scale economies. This is due to the size constraints imposed by governments and also by the technical and economic limits of the power sources. In most jurisdictions, trucks and buses have specific weight and

length restrictions which are imposed for safety reasons. In addition, there are serious limits on the traction capacities of cars, busses and trucks because of the considerable increases in energy consumption that accompany increases in the weight of the unit. For these reasons the carrying capacities of individual road vehicles are limited.

Roads are thus costly infrastructures, but also sources of income:

- Costs. They include rights of passage, development costs (planning), construction costs, maintenance and administration costs, losses in land taxes (urban environment), expropriation costs (money and time), and external costs (accidents and pollution).
- Income. They include registration, gas (taxes), purchases of vehicles (taxes), tolls, parking, and insurance fees.

Road transport, however, possesses significant advantages over other modes. The capital cost of vehicles is relatively small. This produces several key characteristics of road transport. Low vehicle costs make it comparatively easy for new users to gain entry, which helps ensure that the trucking industry, for example, is highly competitive. Low capital costs also ensure that innovations and new technologies can diffuse quickly through the industry. Another advantage of road transport is the high relative speed of vehicles, the major constraint being government-imposed speed limits. One of its most important attributes is the flexibility of route choice, once a network of roads is provided. Road transport has the unique opportunity of providing door to door service for both passengers and freight. These multiple advantages have made cars and trucks the modes of choice for a great number of trip purposes, and have led to the market dominance of cars and trucks for short distance trips.

Road transportation is characterized by acute geographical disparities in traffic. It is not uncommon that 20% of the road network supports 60 to 80% of the traffic. This observation is expanded by the fact that developed and developing countries have important differences in terms of the density, capacity and the quality of road transport infrastructures. Acute geographical variations of the inventory are therefore the norm.

Technological evolution of road transport vehicles was a continuous trend since the construction of the first automobiles. The basic technology is however very similar, as road transportation massively relies on the internal combustion engine. In the future new materials (ceramics, plastics, aluminum, composite materials, etc...), fuels (electricity, hydrogen,

natural gas, etc...) and computerization (vehicle control, location, navigation and toll collection) are expected to be included in cars and improve the efficiency of road transport systems.

Urban population has increased considerably over the last 50 years and about 50% of the global population was urbanized by 2000 (about 3 billion people). It is impossible for developing countries to have rates of individual vehicle ownership similar to those of developed countries, especially compared with the United States. This will impose new or alternative methods to transport freight and passengers over roads in urban areas. The reduction of vehicle emissions and the impacts of infrastructures on the environment are mandatory to promote a sustainable environment. Under such circumstances cycling is thus to be considered an alternative to the automobile in urban areas, widely adopted in developing countries, although more for economic reasons. A symbiosis between types of roads and types of traffic with specialization (reserved lanes and hours) is to be expected.

Ex. 7. Answer the following questions.

1. What are the main problems of road transportation?
2. What are the main types of road ownership?
3. Why will the quality of the road be directly linked with revenue generation?
4. Why do all road transport modes have limited abilities to achieve scale economies?
5. Why does road transport possess significant advantages over other modes of transport?
6. What fact will impose new or alternative methods to transport freight and passengers over roads in urban areas?
7. What is considered as an alternative means of transport to the automobile in urban areas?

Ex. 8. Substitute the words in Russian with their appropriate equivalents in English.

1. New types of problems, **such as a significant (рост потребления топлива), (увеличение ущерба окружающей среде)**, traffic congestion and a **(увеличение ДТП)** have emerged. 2. **(Доход)** includes registration, gas **(налоги)**, **(покупка)** of vehicles (taxes), **(сборы)**, parking, and

(страховые сборы). 3. Unlike governments, (частные) enterprises have (законные интересы) to see that the road segments they manage are maintained and improved. 4. In many cases, governments have been (не умелые смотрители) of road infrastructure. 5. Trucks and buses have specific weight and (ограничение по длине) which are (налагаются) (по соображениям безопасности). 6. Road infrastructures are moderately expensive to provide, but there is a (расхождение в ценах), from a (гравийная дорога) to a (городская многорядная автострада). 7. The majority of (платные дороги) are highways linking large cities or (мосты) and tunnels where there is a (схождение движения). 8. Low vehicle costs ensure that the (грузоперевозки) is highly (конкурентны). 9. (Развитые) and (развивающиеся страны) have important differences (с точки зрения) the (плотности), (мощности) - and the quality of road transport infrastructures. 10. The (сокращение выбросов транспортных средств) and the (влияние) of infrastructures on the environment are (обязательны) to promote a (устойчивая окружающая среда). 11. However, all (виды дорожного транспорта) have limited abilities to achieve (экономики масштаба) due to the (ограничения по размерам) imposed by governments. 12. The (строительство) and (содержание дорог) is cheaper when the system is extensive, but to a limit. 13. The (грузоподъемность) of (личных автомобилей) are limited. 14. (Дорожные перевозки) is the mode that has (расширен) the most over the last 50 years, both for passengers and (грузоперевозки).

Ex. 9. Fill in the blanks with the appropriate prepositions.

1. Governments can expropriate the necessary land ... road construction since a private enterprise may have difficulties to expropriate ... government support. 2. Trucks and busses have specific weight and length restrictions which are imposed ... safety reasons. 3. There is a wide divergence ... costs, ... a gravel road ... a multi-lane urban expressway. 4. Road transport possesses significant advantages ... other modes. 5. It is impossible ... developing countries to have rates ... individual vehicle ownership, especially compared ... the United States. 6. ... such circumstances cycling is to be considered an alternative ... the automobile ... urban areas ... developing countries, although more ... economic reasons. 7. Road transport has the unique opportunity ... providing door ... door service ... both passengers and freight. 8. The basic technology is



however very similar, as road transportation massively relies ... the internal combustion engine. 9. In addition, there are serious limits ... the traction capacities ... cars and trucks because of the considerable increases ... energy consumption.

Ex. 10. Translate the following sentences into Russian. Mind the use of the modal verbs.

1. Access to infrastructure and allocation of rail infrastructure charges have to be fair to the operators and should be non-discriminatory in relation to other transport modes. 2. In a well functioning market, rail transport can play an essential role as a viable link in the intermodal supply chain and in the logistical strategies of companies. 3. With information technology freight and vehicle flows may be monitored and thus controlled and optimized. 4. It can be expected that the optimum equilibrium between transport, production and inventory costs is highly sensitive to the cost of each of these categories. 5. Rail transport could offer a good alternative for both passengers and freight. 6. It has to be emphasized that the general development of transport systems is matched by a rise in the number of people excluded. 7. The importance of the transportation should also be seen by looking at the impact of transportation on a country's economy.

Ex. 11. Translate the following sentences into Russian. Mind the use of gerund.

1. Delivery may take over great distances and involve switching between transport modes and sectors dispersed over different countries. 2. Carriers try to retain business by maximizing the line-haul under their control. 3. Intermodality enhances the economic performance of a transport chain by using modes in the most productive manner. 4. By reducing transportation emissions globally, it is predicted that there will be significant **positive effects on earth's air quality, acid rain, smog and climate** change. 5. In a modern society it is recognized that there has to be some attempt at providing equality for all kinds of transport, accepting that this is not always possible or even desirable. 6. If financing is not easy for conventional public transport, it is an acute problem when demand is low. 7. With increasing use of e-shopping, deliveries to rural areas cost

more and often the rural dweller has to pay an additional charge to reflect his isolation.

Ex. 12. Give the main points of the text in 4-7 sentences. Use the following clichés:

*The text deals with... . The author points out that... . Attention is drawn to the fact that... . It is pointed out that... . It should be noted that... . The author comes to the conclusion that... . I find the text rather/very... .*

Ex. 13. Translate the following text into Russian. Use the dictionary if necessary.

Travel by public transport has never been so difficult as today. In European Union countries, in thirty years from 1970 to 2000 the modal share of the car has increased of 4.5% from 73.8% to 78.3% while the public transport modal share has decreased of 8.7% from 24.6% to 15.9%. This relative reduction of public transport ridership is the result of major sociological and politico-economic changes. It corresponds to changes in lifestyles, characterized by a new relationship towards time and more flexible schedules, an increasing share of leisure activities. It is also the consequence of urban sprawl with dispersion of the origins and destinations of the journeys, a high increase of journeys from suburb, and on longer distances. The increasing use of cars has been also strengthened by political decisions in favour of private modes, which led to an increasing pressure on public budgets and insufficient financial investment for public transport. The management of mobility has never been as difficult as today. The demand of mobility has become more complex and can not be satisfied by traditional modes of public transport. Against this background, mobility actors and stakeholders have started to provide flexible solutions. They constitute an essential link in the whole mobility chain, either as a complement or as a substitute of traditional public transport. The challenge is therefore to implement innovative solutions to meet the needs for public transport by low demand. In this context it is fundamental to develop flexible solutions to meet the needs when demand is low. Is authorities and operators want to contain the pre-

eminence of the car, they need to consider the whole chain of mobility and reposition public transport as to fill in the gaps left by conventional services. The request is for door-to-door seamless travel by providing the market with one public transport offer that integrates different products from conventional public transport to demand responsive solutions, regardless of the type of providers. Demand Responsive Transport (DRT) can have the potential to improve the effectiveness and the efficiency of providing mobility services. Experience shows that with DRT, public transport actors can found cost-effective means of meeting societal needs where there was previously a serious mobility deficit\$ or they succeeded to achieve effective mobility at reduced pre-trip costs.

## Unit Twelve: Information Technologies in Transport

---

---

Ex. 1. Mind the new words and expressions:

1. aids – **вспомогательные средства**
2. bill of lading - **коносамент, транспортная накладная**
3. compatible - **совместимый; сочетаемый**
4. driving licence - **водительские права**
5. enforcement - **требование о соблюдении (законов, стандартов, норм, тарифов)**
6. to enhance - **увеличивать, усиливать, улучшать**
7. electronic funds transfer (EFT) - **электронный перевод средств (платежей)**
8. to fit - **монтировать; устанавливать;**
9. fleet - **парк (транспортных средств)**
10. HGV - heavy goods vehicle - **большегрузный автомобиль**
11. idle time - **время простоя**
12. immobilization - **потеря подвижности**
13. invoice - **счет-фактура, накладная**
14. maintenance - **техническое обслуживание; ремонт; эксплуатация**
15. occupant - **пассажир**
16. packing slip = packing list - **упаковочная ведомость**
17. penalty – **штраф, наказание**
18. protection device - **защитное устройство, предохранитель**
19. purchase order - **заказ на покупку, доставку**

20. with reference to smb. / smth. — ссылаясь на кого-л. / что-л.
21. reminder - устройство передачи аварийных сигналов
22. road holding – держание дороги (автолюбителем); курсовая устойчивость
23. routing – выбор маршрута, схема движения;
24. smart device - интеллектуальное устройство
25. spacing - интервал, расстояние, промежуток
26. to tackle - пытаться найти решение (каких-л. вопросов)
27. telematics - интегрированные средства обработки и передачи информации

Ex. 2. Match the word with the appropriate definition.

Exchange, driving license, distribution, bar code, technology, telematics.

1. the application of practical sciences to industry or commerce.
2. the division of the total income of a community among its members, esp. between labour incomes (wages and salaries) and property incomes (rents, interest, and dividends).
3. to transfer or hand over (goods) in return for the equivalent value in kind rather than in money; barter; trade.
4. a machine-readable arrangement of numbers and parallel lines of different widths printed on a package, which can be electronically scanned at a checkout to register the price of the goods and to activate computer stock-checking and reordering.
5. the branch of science concerned with the use of technological devices to transmit information over long distances.
6. an official document or certificate authorizing a person to drive a motor vehicle.

Ex. 3. Match the words and word combinations with the similar meaning.

- |                 |                |
|-----------------|----------------|
| 1) to enhance   | a) to regulate |
| 2) penalty      | b) crash       |
| 3) in the event | c) to support  |
| 4) seat belt    | d) passenger   |
| 5) accessible   | e) advantage   |

- |                  |                 |
|------------------|-----------------|
| 6) occupant      | f) safety belt  |
| 7) to adjust     | g) to intensify |
| 8) to provide    | h) available    |
| 9) accident      | i) punishment   |
| 10) to encourage | j) in case of   |
| 11) objective    | k) to supply    |
| 12) benefit      | l) goal         |

Ex. 4. Choose the right variant for each word combination.

- |                             |   |
|-----------------------------|---|
| 1) braking habits           | a) финансовое урегулирование                  |
| 2) on-board computer        | b) ударопрочность                             |
| 3) renewable energy sources | c) оптимальная маршрутизация                  |
| 4) vehicle spacing          | d) профилактические меры                      |
| 5) repair shop              | e) ремонтная мастерская                       |
| 6) financial settlement     | f) стиль вождения                             |
| 7) optimal routing          | g) возобновляемые источники энергии           |
| 8) heat engine              | h) пристегнуть ремни безопасности             |
| 9) fleet maintenance        | i) расстояние между автомобилями              |
| 10) hydrogen fuel cells     | j) бортовой компьютер                         |
| 11) onboard driving aids    | k) тепловой двигатель                         |
| 12) prevention measures     | l) обслуживание парка                         |
| 13) impact resistance       | m) система предупреждения                     |
| 14) improved road holding   | n) интеллектуальное устройство защиты         |
| 15) slippery surface        | o) водородные топливные элементы              |
| 16) warning system          | p) бортовые вспомогательные средства вождения |
| 17) smart protection device | г) специализированная защита                  |
| 18) tailored protection     | с) скользкая поверхность                      |
| 19) to wear seatbelts       | t) улучшенное содержание дороги               |

Ex. 5. Look at the title and say what information the text gives. Read the text attentively for the details.

Information technologies in transport

Information technology (IT) is process and "act upon" information at the right time and place, makes greater market intelligence possible. IT is instrumental in supporting the basic internal and inter-company transactions associated with distribution, transport and related services, i.e.: preparation of the logistics process; planning of the process; operations and control; financial settlement; fleet maintenance and monitoring.

The benefits of all information technology innovations in road freight operations result from improved, real-time electronic exchange of, and acting upon, data and information. Information technology innovations enable or will require the electronic exchange of data and information concerning:

- cargo, vehicle and driver identification and status;
- vehicle location;
- current traffic conditions;
- optimal routing, taking into consideration the availability of loads and appropriate equipment to move them, traffic and weather conditions, the nature of the cargo being transported, using routing algorithms or "artificial intelligence" (so-called "real-time routing");
- optimal routing of cargo (package or whole shipments);
- optimal routing of load units (trailers, containers, swap bodies, etc).

Here are the main innovations in information technology:

1. *Automatic vehicle identification*: transmits vehicle information (identification, size and weight, vehicle type or class);

2. *Bar coding*: provides product & picking information (identification, size and weight, origin and destination);

3. *Electronic data interchange*: transmits business data and provides electronic business documentation (purchase order; bill of lading; packing slip; invoice; electronic funds transfer);

4. *In-vehicle navigation systems*: provides driver with information (highway and traffic conditions; location (of vehicle, destination, etc.); alternate routes; automatic vehicle spacing);

5. *On-board computer (mobile IT)*: monitors vehicle and driver behavior (vehicle speed; engine idle time; engine oil temperature & pressure; vehicle stop time and distance; driver's braking habits);

6. *Two-way communication systems*: exchange messages between dispatcher and driver (trip and shipment information; location (of vehicle, destination, etc.) including location of maintenance and repair shops).

Technological innovation provides an excellent opportunity to integrate the transport modes, optimise their performance, make them safer and help make the European transport system compatible with sustainable transport development.

Technology development in the transport field is estimated at around EUR 1.7 billion, in such areas as intermodality, energy and the technology of means of transportation, including telematics applications.

The strategic objectives deal with the reduction of greenhouse gases and pollutant emissions, the security of energy supply and the balanced use of the various transport modes. The research is focused on actions to develop renewable energy sources and on cleaner and more efficient energy use, especially in urban areas, and to develop new transport concepts that are cleaner and more energy efficient.

The development of a new generation of hybrid electric cars (electric motor combined with a heat engine) and cars which run on natural gas or, in the longer term, hydrogen fuel cells, looks very promising.

Technological developments enhance the usual methods of control and penalties, with the introduction of automatic devices and onboard driving aids. In the same context, the eventual fitting in road vehicles, as in other forms of transport, of black boxes to record parameters which help explain the causes of accidents, will make motorists more responsible and enable more effective prevention measures to be taken. The introduction of electronic driving licenses could also help with the enforcement of penalties, such as the immobilisation of vehicles whose drivers have lost their licenses.

Intelligent transport systems are another opportunity. In this context, it would be useful to encourage the introduction of active safety systems for all new vehicles. Fitted with innovative technologies, for example, in the area of traffic management and collision-avoidance systems, such vehicles hold out the prospect of road safety being improved by 50%.

**Technological progress should also increase vehicles' impact resistance** thanks to the development of new materials and the introduction of new advanced design processes for structural integrity. Current progress with tyres (reduced water projection for HGV tyres, improved road holding on slippery surfaces, warning system to indicate under-inflated tyres) should in the short term make for reduced fuel consumption and rolling

noise while maintaining a high level of safety. This should produce a 10% saving on fuel and around 1 000 fewer deaths per year.

Protection of vehicle occupants in the event of impact is progressing remarkably. Electronic systems will enable new smart protection devices (airbags for example) to adjust for the number of vehicle occupants, their morphology and the nature of the impact so as to provide more tailored protection. Reminders to put safety belts on must become standard vehicle equipment. In Sweden, 95% of car occupants wear their seatbelts. However, half of all those killed in accidents were not wearing their seatbelts at the time of the accident.

Finally, as the volume of traffic increases, better vehicle-speed management is an essential aspect of safety that will also help tackle congestion. In addition to improved road safety, observation of speed limits will also reduce greenhouse gas emissions significantly. The most promising prospects here are offered by new technologies that can determine optimum speed at any moment with reference to traffic conditions, road features and external conditions (such as weather) and pass the information on to drivers by way of information display boards or on-board communication systems. Roads and vehicles throughout the Union need to be equipped with these new technologies as soon as possible, and information systems made accessible to everyone.

Ex. 6. Provide answers to the following questions.

1. **What is ‘information technology’?**
2. What do information technology innovations enable?
3. What are the main innovations in information technology?
4. What does technological innovation provide?
5. Protection of vehicle occupants in the event of impact is progressing **remarkably, isn't it?**

Ex. 7. Substitute the words in Russian with their appropriate equivalents in English.

1. Technological innovation (**обеспечивает**) an excellent (**возможность**) to integrate the (**виды транспорта**), make them safer and help make the European transport system (**совместимой**) with (**устойчивое**) transport development. 2. (**Бортовой компьютер**) monitors vehicle and (**поведение водителя**): vehicle speed; engine (**время про-**



стоя); (расстояние); driver's (стиль вождения). 3. In addition to improved (безопасность дорог), observation of (ограничение скорости) will also (уменьшит) greenhouse gas (выбросы) significantly. 4. The most (обещающий) prospects are offered by new technologies that can (определять) optimum speed at any moment with reference to (условия движения), (характеристиками дорог) and external conditions and pass the information on to drivers by way of information display boards or (бортовая система связи). 5. Technological (разработки) enhance the usual methods of control and (штрафов), with the introduction of automatic devices and (бортовых вспомогательных средств вождения). 6. As the (объем движения) increases, better (управление скоростью автомобиля) is an essential aspect of (безопасность) that will also help (решать проблему заторов). 7. IT is instrumental in supporting the basic (сделки) associated with (распределением), transport and (финансовое урегулирование); fleet (техническое обслуживание) and monitoring. 8. (Защита) of vehicle (пассажиров) (в случае столкновения) is progressing remarkably. 9. Information technology innovations (требуют) the electronic (обмен данных) and information concerning; (груз); vehicle location; current (условий движения); optimal (схемы движения груза). 10. The eventual (установка) in road vehicles, as in other forms of transport, of (черных ящиков) to record parameters which help explain the (причина аварий), will make motorists more (ответственный) and enable more effective (профилактические меры) to be taken.

Ex. 8. Fill in the blanks with the appropriate prepositions.

1. Roads and vehicles ... Europe need to be equipped ... these new technologies as soon as possible. 2. It would be useful to encourage the introduction ... active safety systems ... all new vehicles. 3. Reminders to put safety belts ... must become standard vehicle equipment. 4. Protection ... vehicle occupants ... the event ... impact is progressing remarkably. 5. Half ... all those killed ... accidents were not wearing their seatbelts ... the time ... the accident. 6. Information technology is instrument ... supporting the basic internal and inter-company transactions associated ... transport and related services. 7. Technological developments enhance the usual methods ... control and penalties ... the introduction of automatic devices. 8. The research is focused ... actions to

develop renewable energy sources and ... cleaner and more efficient energy use, especially ... urban areas. 9. The strategic objective deals ... the security ... energy supply. 10. The benefits ... all information technology innovations ... road freight operations result ... improved, real-time electronic exchange ... data and information. 11. Two-way communication systems exchange messages ... dispatcher and driver ... location ... vehicle, destination, etc.

Ex. 9. Translate the following noun+noun constructions into Russian.

- |  |   |
|--|---|
| 1. mass production industries          | 10. manufacturing flow management             |
| 2. material flow system                | 11. demand forecast data                      |
| 3. road transport markets              | 12. freight transport services                |
| 4. market observation system           | 13. raw material inventory stock level        |
| 5. public transport users              | 14. transport sector energy consumption       |
| 6. transport logistics characteristics | 15. door-to-door delivery system              |
| 7. supply chain management             | 16. air traffic control system                |
| 8. customer relationship management    | 17. traffic accident statistics               |
| 9. Road safety audits and inspections  | 18. supply chain business process integration |

Ex. 10. Translate the sentences into Russian, paying attention to the infinitive.

1. Transport telematics is assumed to contribute to goal achievement in the transport sector in Norway. 2. Even though the drivers seem to acknowledge falling asleep as an important cause in road accidents, few drivers seem aware of the severity of sleep-related accidents. 3. Road transport growth is expected to soar in Eastern Europe. 4. Logistics experts consider it is increasingly important for manufacturers, distributors and retailers to focus on efficiency in seeking out solutions to meet their specific transportation requirements. 5. Very few measures have been taken to provide a basic regulation of social conditions in the road trans-

port sector. 6. What is needed is to make rail transport once again competitive enough to remain one of the leading players in the transport system in the enlarged Europe. 7. The concept of containerization is considered to be the key innovation in the field of logistics which has revolutionized freight handling in the twentieth century. 8. As the Internet and other new communication technologies are developing, it is expected to bring more innovations which further simplify the tasks of logistics. 9. Today various mathematical and analytical methods are available to solve the problems of vehicle routing.

Ex. 11. Translate the sentences into Russian, paying attention to the **use of the verb 'to have' in different functions.**

1. Rail has always been far safer than road. 2. A free exchange of persons, commodities and capital has far reaching implications for intra-European trade and transport. 3. Around 1/3 of passengers have to change buses in the course of their actual journey. 4. With the **convergence of Europe's economies, trade relations and the subsequent need** for transport of goods and passengers have immensely increased. 5. Governmental authorities in charge of public works have the legal obligation to ensure road safety at any time and without restriction. 6. Road safety audits and inspections have to be implemented to guarantee continuous high safety standards and to supervise the overall road safety criteria. 7. Today containerization has become the integral part of logistics, which has revolutionized the cargo shipping. 8. To build up inventory sufficient capital has to be tied up for a length of time. 9. In business, logistics may have either internal focus (inbound logistics) or external focus (outbound logistics) covering the flow and storage of material from point of origin to point of consumption. 10. Sophisticated control systems have to be developed and used in the nearest future.

Ex. 12. Give the main points of the text in 4-7 sentences. Use the following clichés:

*The text deals with... . The author points out that... . Attention is drawn to the fact that... . It is pointed out that... . It should be noted that... . The author comes to the conclusion that... . I find the text rather/very... .*

Ex. 13. Translate the following text into Russian. Use the dictionary if necessary.

The Department of Transportation has contributed \$18mIn towards the project as part of its efforts to find new ways to cut congestion in big cities. Donald Shoup, a professor of urban planning at the University of California, Los Angeles, thinks parking should be made easier to find so as to help public transport flow more freely and to reduce the amount of carbon dioxide spewed out by motorists in their endless searching for somewhere to stop.

The SFpark project will begin early in 2009 with a new network of **pavement sensors in 6,000 of San Francisco's metered parking** spaces and 11,500 of its off-street car parks and garages. These sensors will detect when a space is taken and relay that information to a central database. From there, information about vacant parking spots will pass to drivers in several ways. The most basic will be through a network of road signs that will indicate areas with parking places. Eventually, however, officials want to provide web and mobile phone services that display the availability of parking block by block on a colour-coded map, much like the traffic maps now offered by Google.

The city also plans to make parking metres capable of two-way communications. This will allow them to accept credit and debit card payments, seek maintenance and (perhaps to less acclaim) alert Lovely Rita when a parking ticket needs to be issued. Crucially, such metres can also be changed remotely to charge different rates **according to demand at different times of the day.** “**If you get the price right, nobody will have to cruise,**” adds Dr Shoup.

A number of companies already have detection systems at work. **Streetline's technology, for instance, presents networks of small, cheap, low-powered sensors.** The company's pavement sensors will run for more than five years on two AA batteries. Like those from other companies, they detect a disturbance in the magnetic field from a hunk of metal (that is, a car). Data can hop from sensor to sensor until it makes its way to a gateway, a small box sitting on top of a streetlamp or traffic-signaling box. From there, it can travel to the central database via the mobile-phone network or municipal Wi-Fi.

Streetline's sensors have already been tested in parts of San Francisco and by the end of the year they will be deployed in 3,500 parking spaces in Los Angeles. The company hopes eventually to **create networks that monitor other bits of a city's infrastructure too**, including traffic flows, street lamps and water mains.

VehicleSense is testing its wireless-sensor networks in parking areas along Interstate 95 in south-eastern Massachusetts. The idea is to give fatigued truckers better information on where they can pull off the road to get some sleep. This technology can go only so far towards relieving congestion and helping drivers find parking spaces.

Учебное издание

БОЯРСКАЯ Анна Олеговна  
ПЕДЬКО Людмила Владимировна  
СЛЕСАРЕНОК Екатерина Викторовна

ENGLISH FOR TRANSPORTATION

Английский язык для специалистов по организации перевозок

Компьютерная верстка Е. В. Слесаренок

---

Подписано в печать 26.05. 2009.

Формат 60X84 1/16 .Бумага офсетная.

Отпечатано на ризографе. Гарнитура Таймс.

Усл. печ. л. 6,51. Уч. - изд. л. 5,09. Тираж 150.

Заказ 549.

---

Издатель и полиграфическое исполнение:

Белорусский национальный технический университет.

ЛИ № 02330/0494349 от 016.03.2009.

Проспект Независимости, 65. 220013, Минск.

Министерство образования Республики Беларусь  
Белорусский национальный технический университет  
Кафедра английского языка № 1

Боярская А.О.  
Ладутько Н.Ф.  
Митьковец Т.Е.

TRANSPORT BUSINESS DOCUMENTATION

Минск 2012

# PART 1

---

## I. Business Documentation

*The text below gives some information about business documentation. Read the text carefully and be ready to answer the following questions:*

1. What are the main types of documents used in business?
2. What is the main aim of business and commercial letters?
3. When does a buyer usually send out enquires and what for?
4. What is important in placing an order?
5. When can buyers make claims?
6. How are contracts classified according to the purpose and content?

### Business Documentation

Documents play a very important role in business. They strengthen production process both inside the company and with other organizations. Documents often serve as written argument in different kinds of disputes. There are a lot of documents used in business.

1. Business and commercial letters. This kind of documents is used to inform a partner about the important information or warn about appeared problems. The layout of business letter is more or less common in all countries and contains the following parts: the letterhead, the return address, the date, the inside address, the opening salutation, the body of the letter, the closing salutation and the signature.

2. Enquires. When a buyer wants to know at what price and on what terms he could buy the goods, he usually sends out enquires to firms, companies or organizations. Most letters of enquiry are short and simple. Often the buyer asks the seller to send him illustrated catalogues, price lists or samples and patterns of the goods.

3. Offers. Offers usually state the nature and description of the goods offered, the quantity, the price, the terms of payment and the time and place of delivery.

4. Orders. In order the buyer points at the quantity, quality, catalogue number, packing etc. of the goods he has required, conditions and qualifications, and alternatives which are acceptable if the goods ordered are not



available. In placing of an order accuracy is essential, because errors and misprints can cause trouble which it may be impossible to put right later.

5. Claims. In spite of all possible care and attention that is given to contracts letters of complaint happen to arrive rather frequently. Buyer can make claims arising from the delivery of wrong, damaged or substandard goods, connected with delays, owing to goods missing from delivery, concerned errors in carrying out the order. Sellers make claims because of default of payment. If the parties in disputes cannot meet mutual understanding they can settle commercial disputes by arbitration.

6. Contract. Contract is an agreement between two or more competent parties (legal entities). A contract may be verbal or written. According to the purpose and contents, contracts can cover: goods, services, licenses, patents, technology and know-how. Usually contracts contain the following articles: subject matter of the contract; price and total amount; terms of payment; dates of delivery; liabilities; packing; marking; shipment; quality; acceptance; guarantee; force majeure; arbitration; other conditions, etc.

---

## II. Contract

*1. This is an example of a contract given both in English and Russian. Study the main parts of this contract carefully.*

*Brighton, England*

*April 10, 1997*

Continental Equipment Plc, Brighton, England, hereinafter referred to as "the Seller", on the one part, and TST Systems Ltd., Minsk, Belarus, hereinafter referred to as "the Buyer", on the other part, have concluded the present Contract for the following:

**Брайтон, Англия**

**10 апреля, 1997 г.**

**Компания Continental Equipment Plc, Брайтон, Англия, в дальнейшем именуемая «Продавец», с одной стороны, и компания ТСТ Системз Лтд., Минск, Беларусь, в дальнейшем именуемая «Покупатель», с другой стороны, заключили настоящий контракт о нижеследующем:**

<p><i>1. Subject of the Contract</i></p> <p>1.1. The Seller has sold and the Buyer has bought the machinery, equipment, materials, and services ("Equipment") as listed in Appendix 1 being an integral part of this Contract.</p>	<p><i>1. Предмет контракта</i></p> <p>1.1. Продавец продал, а Покупатель купил машины, оборудование, материалы и услуги («Оборудование»), перечисленные в Приложении 1, которое является неотъемлемой частью настоящего Контракта.</p>
<p><i>2. Prices and Total Value of the Contract</i></p> <p>2.1. The Total Contract Value is as following:</p> <p>Equipment and engineering FOB U.K. port +documentation _____ £</p> <p>Supervision, start-up and training _____ £</p> <p>Spare and wear parts _____ £</p> <p>Freight _____ £</p> <p>Total price CIF Odessa _____ £</p> <p>Discount _____ £</p> <p>Total Contract Value _____ £</p>	<p><i>2. Цены и общая сумма Контракта</i></p> <p>2.1. Общая сумма Контракта составляет:</p> <p>Оборудование и техника на условиях FOB (порт Великобритании)+документация _____ £</p> <p>Сопровождение, пуск и подготовка персонала _____ £</p> <p>Запасные и изнашиваемые детали _____ £</p> <p>Фрахт судна _____ £</p> <p>Общая сумма на условиях CIF Одесса.</p> <p>Скидка _____ £</p> <p>Общая сумма Контракта _____ £</p>
<p>2.2. The prices are understood to be CIF Odessa including cost of packing, marking, loading on board a ship, stowing and fastening the equipment in the hold, and the cost of the materials used for this purpose.</p>	<p>2.2. Цены считаются на условиях CIF Одесса, включая стоимость упаковки, маркировки, погрузки на борт корабля, укладки и крепления в трюме, а также стоимость материалов, используемых для этих целей.</p>
<p>2.3. The prices are firm for the duration of the Contract and shall not be subject to any revision except on</p>	<p>2.3. Цены остаются неизменными на протяжении всего срока действия контракта и могут</p>

<p>account of any mutual agreed changes or modifications to equipment specification and/or quantities listed in Appendix 1 to this Contract.</p>	<p>быть пересмотрены только в случае взаимно согласованных изменений в спецификации на оборудование либо его модификации, а также изменения количества его составных частей, указанного в Приложении 1 к настоящему Контракту.</p>
<p><i>3. Time of Delivery</i> 3.1. The equipment specified in Appendix 1 of the present Contract is to be delivered within two (2) months from the date of opening the Letter of Credit specified in Clause 4.1 of this Contract.</p>	<p><i>3. Срок поставки</i> 3.1. Оборудование, перечисленное в приложении 1 к настоящему Контракту, должно быть поставлено в течение двух (2) месяцев с момента открытия аккредитива, указанного в п.4.1 данного Контракта.</p>
<p>3.2. The delivery date is understood to be the date of the clean Bill of Lading issued in the name of the Buyer, destination Odessa port of Ukraine.</p>	<p>3.2. Датой поставки оборудования считается дата выдачи чистого коносамента с указанием имени Покупателя и конечного порта назначения — Одесса, Украина.</p>
<p><i>4. Terms of Payment</i> 4.1. Within thirty (30) days from the date of signing this Contract, the Buyer is to open in favour of the Seller an irrevocable confirmed Letter of Credit with CityBank, London, for hundred per cent (100%) of the total contract value. The Letter of Credit is to be valid for three (3) months.</p>	<p><i>4. Условия оплаты</i> 4.1. В течение тридцати (30) дней с момента подписания данного Контракта Покупатель должен открыть в CityBank (Лондон) на имя Продавца безотзывный подтвержденный аккредитив на сто процентов (100%) от общей суммы контракта. Аккредитив действителен в течение трех (3) месяцев.</p>

4.2. Payment from this Letter of Credit at the rate of hundred per cent (100%) of the total contract value is to be effected in GB pounds against the following shipping documents:	4.2. Платеж по данному аккредитиву в размере ста процентов (100%) от общей суммы Контракта производится в английских фунтах против предоставления следующих отгрузочных документов:
4.2.1. Original Bill of Lading issued in the name of the Buyer, destination Odessa Port of Ukraine.	4.2.1. Оригинала коносамента, выписанного на имя Покупателя, с указанием конечного порта назначения — Одесса (Украина).
4.2.2. Shipping Specification.	4.2.2. Отгрузочной спецификации
4.2.3. Certificate of Quality.	4.2.3. Сертификата качества.
4.2.4. Certificate of Origin.	4.2.4. Сертификата происхождения товара.
4.2.5. Packing List.	4.2.5. Упаковочного листа.
4.2.6. Insurance Policy.	4.2.6. Страхового полиса.
5. <i>Technical Documentation</i> 5.1. Within five (5) days from the delivery date the Seller shall send two (2) sets of the technical documents as listed in Appendix 2 to the address of the Buyer	5. <i>Техническая документация</i> 5.1. В течение пяти (5) дней с момента поставки Продавец должен выслать в адрес Покупателя два (2) комплекта технических документов, перечисленных в Приложении 2.
5.2. All instructions on the drawings are to be in English, with all	5.2. Все пояснения на чертежах должны быть на английском

<p>the instructions contained in Items 3.2.3, and 4 of Appendix 2 translated into Russian.</p>	<p>языке. Должны также быть предоставлены переводы на русский язык всех пояснений на чертежах, входящих в п.п. 1, 2, 3 и 4 Приложения 2.</p>
<p><i>6. Guarantee of the Quality of the Equipment.</i> 6.1. The guarantee period is twelve (12) months from the date of the start-up of the equipment, that is reflected in an appropriate Act signed by the representatives of the Parties to the present Contract, but not more than eighteen (18) months from the date of delivery of the equipment.</p>	<p><i>6. Гарантия качества оборудования</i> 6.1. Гарантийный срок составляет двенадцать (12) месяцев с момента пуска оборудования, что фиксируется в соответствующем Акте, подписанном уполномоченными представителями сторон, заключающим настоящий Контракт, но не более восемнадцати (18) месяцев с даты поставки оборудования.</p>
<p>6.2. If the equipment proves to be defective or faulty during the guarantee period, the Seller has at its expense at the choice of both Parties either to remedy the defects or to replace. The faulty equipment with the new equipment of good quality which is to be delivered without delay to the port of delivery.</p>	<p>6.2. Если оборудование выйдет из строя на протяжении гарантийного срока, Продавец должен за свой счет и по усмотрению обеих сторон, либо устранить возникшие дефекты, либо заменить вышедшее из строя оборудование на новое оборудование соответствующего качества, которое должно быть без задержки доставлено в порт назначения.</p>
<p><i>7. Packing</i> 7.1. The equipment is to be shipped in export sea packing suitable for the type of equipment delivered. Packing should also be suitable for</p>	<p><i>7. Упаковка</i> 7.1. Оборудование поставляется в морской экспортной упаковке, предназначенной для транспортировки оборудования дан-</p>

<p>transshipment in transit and reasonable long storage of the equipment.</p>	<p>ного типа. Упаковка должна также быть пригодной для транзитных перевозок и для хранения оборудования в течение разумного срока.</p>
<p>7.2. Each container is not to exceed the following dimensions: length = 2,500 mm, width = 2,500 mm, height = 2,500 mm.</p>	<p>7.2. Каждый контейнер по размерам не должен превышать следующих габаритов; длина — 2 500 мм, ширина - 2 500 мм, высота — 2 500 мм.</p>
<p>7.3. The Seller is responsible to the Buyer for any damage to the equipment resulting from inadequate packing of the equipment.</p>	<p>7.3. Продавец несет перед Покупателем ответственность за любые повреждения оборудования из-за его неправильной упаковки.</p>
<p><i>8. Marking</i> 8.1. All the containers are to be marked on the three (3) sides. Each container should bear the following markings made in indelible paint (in Russian and English):</p>	<p><i>8. Маркировка</i> 8.1. Все контейнеры маркируются с трех (3) сторон. На каждом контейнере должны быть нанесены несмываемой краской следующие надписи (на русском и английском языках):</p>
<p>Contract No. <i>Seller:</i> Continental Equipment Plc (Address)  <i>Buyer:</i> TST Systems Ltd. (Address) <i>Railway Station of Destination:</i> Minsk <i>Container No.:</i> <i>Gross weight:</i> _____ kgs <i>Net weight:</i> _____ kgs</p>	<p>Контракт № <i>Продавец:</i> Continental Equipment Plc (Адрес)  <i>Покупатель:</i> TST Systems- Ltd. (Адрес) <i>Ж/д станция назначения:</i> Минск <i>Контейнер N:</i> <i>Вес брутто:</i> _____ кг <i>Вес нетто:</i> _____ кг</p>

<p>Case <i>dimensions in cm</i> (length x width x height)</p>	<p><i>Размеры контейнера в см</i> (длина x ширина x высота)</p>
<p>8.2. If a case requires special handling it should bear additional marks; "Fragile", "Top" or "This side up", etc.</p>	<p>8.2. Если контейнер требует специального обращения, то на нем должна быть нанесена дополнительная маркировка: «Хрупкий», «Верх» или «Здесь, верх» и т. п.</p>
<p><i>9. Shipping Instructions and Notifications</i> 9.1. Within twenty-four (24) hours after shipment, the Seller is to inform the Buyer by fax regarding the date of shipment, the Bill of Lading number, number of containers, their weight, the vessel name.</p>	<p><i>9. Уведомление об отгрузке</i> 9.1. В течение двадцати четырех (24) часов после отгрузки оборудования Продавец должен сообщить Покупателю по факсу дату отгрузки, номер коносамента, количество контейнеров, их вес, название судна.</p>
<p><i>10. Insurance</i> 10.1. The Seller is to take care of and cover expenses for insurance of the equipment under the Contract from the moment of its dispatch up to the moment of its arrival at the port of Odessa.</p>	<p><i>10. Страхование</i> 10.1. Продавец производит страхование оборудования, поставляемое в соответствии с настоящим Контрактом, и покрывает все связанные с этим расходы с момента отгрузки оборудования и до момента прибытия его в порт Одессы.</p>
<p><i>11. Sanctions</i> 11.1. In the event of delay in delivery of the equipment the Seller is to pay the Buyer a penalty at the rate of 1,0% of the total contract value for every week of delay. However, the total amount of penalty for delay in delivery is not to</p>	<p><i>11. Санкции</i> 11.1. В случае задержки в поставке оборудования Продавец должен выплатить Покупателю пени в размере 1 % от общей суммы Контракта за каждую неделю задержки в поставке. При этом общая сумма пени за</p>

<p>exceed 10% of the total contract value.</p>	<p>задержку в поставке оборудования не должна превышать 10 % от общей суммы Контракта.</p>
<p>11.2. While calculating penalty for delay, the amount of days comprising over half of a calendar week is considered to be a full week.</p>	<p>11.2. При расчете пени за задержку в поставке оборудования количество дней, превышающее половину календарной недели, считается как полная неделя задержки.</p>
<p><i>12. Force Majeure</i> 12.1. The Parties are released from their responsibility for partial or complete non-execution of their liabilities under the Contract should this non-execution be caused, by the force majeure circumstances including but not limited to: fire, flood, earthquake, and if these circumstances have had a direct damaging effect on the execution of the present Contract.</p>	<p><i>12. Форс-мажор</i> 12.1. Стороны освобождаются от ответственности за полное либо частичное невыполнение своих обязательств по настоящему Контракту, если такое невыполнение было вызвано форс-мажорными обстоятельствами, которые включают, но не ограничиваются такими причинами, как пожар, наводнение, землетрясение, и если данные обстоятельства оказали непосредственное влияние на возможность выполнения этих обязательств.</p>
<p>12.2. The Party which is unable to fulfill its obligations under this Contract is to inform the other Party within ten (10) days from the beginning of force majeure circumstances.</p>	<p>12.2. Сторона, которая не может выполнить своих обязательств по настоящему Контракту, должна в течение десяти (10) дней после начала действия форс-мажорных обстоятельств проинформировать другую сторону об их наличии.</p>



<p><i>13. Arbitration</i></p> <p>13.1. The Seller and the Buyer will take all possible measures to settle amicably any disputes or differences which may arise out of the present Contract or in connection with it</p>	<p><i>13. Арбитраж</i></p> <p>13.1. Покупатель и Продавец принимают все возможные меры для урегулирования споров и разногласий, которые могут возникнуть при выполнении настоящего Контракта, или в связи с его выполнением.</p>
<p>13.2. If the Parties do not come to an agreement, all the disputes and differences are to be submitted for Arbitration in Stockholm, Sweden, in accordance with the rules and regulations of the Chamber of Commerce in Stockholm and applying the substantive laws of Sweden.</p>	<p>13.2. Если стороны не могут прийти к соглашению, споры и разногласия представляются на рассмотрение арбитражного суда в Стокгольме (Швеция) в соответствии с правилами и положениями Торговой Палаты Стокгольма и с применением соответствующих законов Швеции.</p>
<p><i>14. Other Terms</i></p> <p>14.1. The Seller upon written consent of the Buyer shall be permitted to substitute equipment of comparable quality and conforming to the technical requirements for any item of equipment that may not be available for one reason or another.</p>	<p><i>14. Другие условия</i></p> <p>14. 1. При наличии письменного согласия Покупателя Продавец может произвести замену тех или иных частей оборудования, которых по той либо иной причине нет в наличии, на удовлетворяющее техническим требованиям оборудование сопоставимого качества.</p>
<p>14.2. Any changes, amendments or supplements to the terms and conditions of this Contract shall be valid only if set forth in a written document duly signed by authorized representatives of both Parties</p>	<p>14.2. Любые изменения, поправки и дополнения условий настоящего Контракта считаются действительными только в том случае, если они сделаны письменно и должным образом</p>

to the present Contract.	подписаны уполномоченными представителями сторон.
14.3. After the Contract has been signed all the preliminary agreements, discussions and correspondence between the Parties concerning this Contract are to be considered null and void if conflicting with this Contract.	14.3. После подписания Контракта все предварительные соглашения, договоренности и переписка между сторонами, заключившими настоящий контракт, становятся недействительными, если они входят в противоречие с положениями данного Контракта.
14.4. The Contract becomes effective and comes into full force from the date of signing.	14.4. Контракт становится действительным и входит в полную силу с даты его подписания.
<i>15. Legal Addresses of the Parties</i> SELLER (ПРОДАВЕЦ): Continental Equipment Plc 9 North Road Brighton BN1 5JF England	<i>15. Юридические адреса сторон</i> ПОКУПАТЕЛЬ (BUYER): TST Systems Ltd. Minsk 223100 Belarus
for and on behalf of the Seller	от имени и по поручению Покупателя
<i>Alfred Rogers</i> <i>Chairman (Президент)</i>	Виктор Петренко Коммерческий директор (Commercial Director)

*2. Read the text of the contract once more and give the proper English equivalents for:*

1. срок поставки; 2. в дальнейшем именуемая; 3. условия оплаты; 4. гарантийный срок составляет двенадцать месяцев с момента пуска оборудования; 5. маркировка несмываемой краской; 6. страхование покрывает все расходы с момента отгрузки оборудования и до момента прибытия; 7. форс-мажорные обстоятельства; 8. сертификат происхождения товара; 9. от имени и по поручению; 10. в случае задержки; 11. сопровождение, пуск и подготовка персонала; 12. предварительные соглашения становятся недействительными; 13. несет ответственность за любые повреждения оборудования из-за неправильной упаковки; 14. аккредитив действителен в течение трех месяцев; 15. упаковочный лист; 16. за свой счет заменить вышедшее из строя оборудование; 17. уведомление; 18. вес брутто, вес нетто; 19. ответственность; 20. общая сумма пени за задержку в поставке не должна превышать 10 % от общей суммы контракта; 21. запасные и изнашиваемые детали; 22. обязательства; 23. страховой полис; 24. юридические адреса сторон; 25. платеж производится против предоставления отгрузочных документов; 26. контракт становится действительным и входит в полную силу с даты его подписания; 27. с одной стороны, ... с другой стороны; 28. сертификат качества; 29. предмет контракта; 30. погрузка на борт корабля; 31. укладка и крепление в трюме; 32. общая сумма контракта; 33. приложение, которое является неотъемлемой частью настоящего контракта; 34. скидка; 35. цены остаются неизменными; 36. с момента открытия аккредитива; 37. открыть на имя продавца безотзывный подтвержденный аккредитив; 38. отгрузочная спецификация; 39. с момента поставки; 40. чертежи; 41. пункт контракта; 42. соответствующий акт; 43. без задержки; 44. пожар, наводнение, землетрясение; 45. сторона, которая не может выполнить своих обязательств по настоящему контракту; 46. представляются на рассмотрение арбитражного суда; 47. Торговая Палата; 48. при наличии письменного согласия; 49. любые изменения, поправки и дополнения считаются действительными; 50. должным образом подписаны уполномоченными представителями.

3. Fill in the gaps with necessary prepositions and translate the sentences into Russian:

1. The Seller is responsible \_\_\_\_\_ the Buyer \_\_\_\_\_ any damage to the equipment resulting \_\_\_\_\_ inadequate packing of the equipment.

2. \_\_\_\_\_ five days \_\_\_\_\_ the delivery date the Seller shall send two sets \_\_\_\_\_ the technical documents.

3. Payment \_\_\_\_\_ this Letter of Credit \_\_\_\_\_ the rate of hundred per cent (100%) of the total contract value is to be effected in GB pounds \_\_\_\_\_ the shipping documents.

4. The Party which is unable to fulfill its obligations \_\_\_\_\_ this Contract is to inform the other Party \_\_\_\_\_ ten days \_\_\_\_\_ the beginning of force majeure circumstances.

5. The Contract becomes effective and comes \_\_\_\_\_ full force \_\_\_\_\_ the date \_\_\_\_\_ signing.

6. \_\_\_\_\_ thirty days \_\_\_\_\_ the date \_\_\_\_\_ signing this Contract, the Buyer is to open \_\_\_\_\_ favour of the Seller an irrevocable confirmed Letter of Credit \_\_\_\_\_ City Bank, London, \_\_\_\_\_ hundred per cent \_\_\_\_\_ the total contract value.

7. The guarantee period is 12 months \_\_\_\_\_ the date \_\_\_\_\_ the start-up of the equipment, that is reflected \_\_\_\_\_ an appropriate Act signed \_\_\_\_\_ the representatives of the Parties to the present Contract, but not more than 18 months \_\_\_\_\_ the date of delivery of the equipment.

8. \_\_\_\_\_ 24 hours after shipment, the Seller is to inform the Buyer \_\_\_\_\_ fax regarding the date \_\_\_\_\_ shipment, the Bill of Lading number, number \_\_\_\_\_ containers, their weight, the vessel name.

4. You have studied the structure of the contract. Be ready to answer the following questions:

1. What are the main items of standard Contract?
2. What are the main shipping documents?
3. What are the main markings used?
4. What are the main force majeure circumstances?
5. What is the total Contract value?

### III. Incoterms

---

1. Mind the abbreviations used to indicate to what extent charges for freight, insurance, etc. are included in the price quoted.

- *ex-works; ex-factory; ex-mill/mills*: Price without any transport (с завода, франко-завод).

- *f.o.r. (free on rail)* 'франко-рельсы; франко-вагон';

- *f.o.t. (free on truck)* 'франко-вагон' (Am), 'франко-грузовик': Price includes delivery to the railway and loading on a truck.

- *f.a.s. (port named)*: Price includes delivery to loading point 'along-side' ship (франка вдоль борта судна).

- *f.o.b. (export port named)*: Price includes delivery to docks and loading onto a ship (франко-борт, фоб).

- *f.o.b. (import port named)* (particularly used in US trade): Price includes all costs up to arrival in the importing country, but not insurance or unloading (франко-борт судна).

- *c.&f. (destination named)*: Price includes all costs up to the named destination but not insurance (стоимость и фрахт).

- *c.i.f. (destination named)*: Price includes all costs including insurance, up to named destination (стоимость, страхование, фрахт - СИФ).

- *ex-ship (import port named)*: Price includes delivery to the named port of destination; the seller is responsible for the goods until the ship arrives (франко-строп судно, с судна).

- *franco quay; ex-dock (import port named)*: Price includes all costs, unloading, customs duties, etc. (франко-причал; с причала).

- *franco domicilium; free delivered*: Price includes delivery to the premises of the buyer or consignee, customs duties paid by seller or consignor (доставка франка).

*The following phrases are used for home trade, in Great Britain:*

- *carriage paid home*: All transport paid by sender (перевозка оплачена). carriage forward: Transport to be paid by buyer (перевозка должна быть оплачена покупателем).

- *franco; free delivered*: All costs paid by sender (доставка франко).

- *C.O.D.*: Goods to be paid for by buyer on delivery (оплачивается при доставке).

2. Match each word in column A with its meaning in column B

A	B
1. THIS SIDE UP	A. Хранить вдали от нагревательных приборов
2. FRAGILE	B. Беречь от влаги (боится сырости)
3. STOW AWAY FROM HEAT	C. Не бросать!
4. USE NO HOOKS	D. Верх здесь!
5. TO BE KEPT COOL	E. Поднимать здесь
6. DO NOT DROP	F. Открывать здесь
7. GLASS – WITH CARE	G. Скоропортящийся продукт
8. PERISHABLE	H. Хранить в прохладном месте
9. TOP	I. Не складировать на палубе
10. KEEP DRY	J. Осторожно!
11. ACID – WITH CARE	K. Не пользоваться крюками
12. OPEN THIS END	L. Осторожно, кислота!
13. DO NOT STOW ON DECK	M. Огнеопасно!
14. INFLAMMABLE	N. Верх!
15. LIFT HERE	O. Осторожно! (Хрупкий груз!)
16. HANDLE WITH CARE	P. Осторожно, стекло!

---

#### IV. TERMS

1. Mind the following definitions of the underlined terms. Translate them into Russian.

The bill of lading (generally abbreviated in correspondence to B/L) is a very important shipping document. Firstly, it is a receipt from the ship-owners, giving details of the shipment in question and the conditions under which they accept it. So it is evidence of a contract. Secondly, the B/L is the legal title to the consignment, and can be used to transfer the right of ownership to the goods.

The term clean B/L means that the ship owners have examined the cargo and accepted it for delivery in 'the like good order and condition'. If the goods do not correspond to the description of them on the bill, it is known as dirty, unclean, foul, or cloused (because a clause has been added to it by the ship-owners, specifying the discrepancy).

The *invoice* is the account of what the buyers have purchased and what they have to pay. The final account, made out when the goods have been despatched, is usually called the commercial invoice. When there is no bill of lading, as in transport by road or rail, the invoice is used when payment is made through a bank.

*2. Translate the following phrases which can be used for enquiries, replies and shipping instructions:*

1. Please quote your inclusive rates on the following (cargo) (consignment)...

2. Please let us know the present freight rates for...

3. **Please advise us of the current rates of freight on...**

4. We would be grateful if you would send us your current tariffs.

5. In view of the fragile nature of the goods we require them to be forwarded by air, and we would therefore be glad to know the lowest rates.

6. Our rates are subject to alteration without previous notice, except the case of special contract.

7. We can offer you a substantial rebate for regular shipments.

8. We thank you for your enquiry of 8 November and attach our quotation for the packing as required. As you know, freight will depend on the size and weight of the (cases) (**packages**).

9. We enclose our shipping instructions form and will be glad if you will fill this in and return it to us, together with a copy of the invoice, for customs clearance abroad; we will then undertake all formalities on your behalf, in accordance with our usual conditions.

10. The goods of your order no.... are packed and ready for despatch, and we would be pleased if you would fill up, sign and return the attached instructions form as soon as possible.

11. We enclose commercial invoice in triplicate; also certificate of origin.

12. As the cargo is to be transshipped at... we shall require through Bs/L.

13. To avoid undue risk of breakage we should like to have the carboys sent by train-ferry.

14. All charges are payable by us and the Bs/L are to be marked 'freight prepaid'.

15. A waybill, giving full particulars, will be sent to you as soon as the consignment is ready for dispatch.

16. We collect your goods to be packed, by any method required for transport by sea, air, rail or road. We arrange shipments to any part of the world and will undertake all formalities on your behalf, clearing all documents and obtaining bills of lading.

17. We have connections throughout the world and as a result of our wide experience we can advise you on suitable packing and method of transport for any country to which you wish to export.

18. Our plant is equipped to handle any type of bulky product, and we provide all the necessary internal fitments, bracing members and cushioning to avoid shock.

19. You can save both time and money by letting us handle all shipping and Customs formalities for you.

20. Our enclosed brochure will give you details of the varied services we can render and we are able to offer special reductions for large shipments.

---

## V. PACKING CONTAINERS

*1. Read and translate into Russian the following definitions of packing containers. Find the appropriate Russian equivalent to each of them given in the box.*

Bag	Case
Bale	Crate
Barrel	Container
Box	Drum
Bundle	Sack
Carboy	Tin. (US can)
Carton	



1. Generally made of paper, linen, canvas, rubber, or plastic, ('*пакет*').

2. A larger, stronger version of a bag usually made of jute. ('*мешок*').

3. Made of light but strong cardboard, or *fibreboard*, it has double lids and bottoms which are fixed together. Sometimes several cartons are made up into a single package, held by metal bands. ('*картонная коробка*').

4. Stronger than a carton, made of wood, cardboard or metal, sometimes with a folding (hinged) lid. ('*ящик из дерева или металла*').

5. A strong container made of wood. For extra strength cases may have *battens* fixed to their tops, bottoms and sides. When thin wood is used, metal bands or wires will be passed around case. Cases are often *lined* with various materials to prevent damage by water, air, insects, etc. ('*прочный ящик, иногда скрепленный рейками*').

6. This is like a case, but is not fully enclosed. It has a bottom and a frame, and is sometimes open at the top. Crates are often built for the particular thing they have to carry. Machinery **packed** in crates needs a special bottom, called *a skid*, to facilitate handling. ('*решетчатая тара*').

7. A very large, robust, metal construction, varying in length from about ten to about forty feet. It is normally sealed at the consignor's *factory* and transported unopened until it reaches its destination. Containers are carried by rail, road and by ship. They may be watertight and airtight, and goods sent in them cannot be lost or stolen. Containers are a recent development, and they can make transportation very economical. ('*контейнер*').

8. A cylindrical container for liquids and powders, usually made of metal or plastic, but sometimes wood or strong cardboard. ('*цилиндрический контейнер*').

9. A wooden drum. Hoops are used to strengthen barrels. There are various sizes of barrels, and some are known as *casks*, *hogsheads* and *kegs*, ('*деревянная бочка, бочонок*').

10. A package of soft goods (usually textiles) ("*кипа, тюк* ") wrapped in protective material.

11. A small metal container which paint, oil and variety of foodstuffs are packed in ("*консервная банка* ").

12. A glass container, used for chemicals, protected in a padded metal or wicker cage. ("баллон, бутылъ").

13. Miscellaneous goods packed without a container. ("связка, пачка, жгут").

---

## VI. MARKING

1. Read the passage below and fill in each gap with the appropriate word given in the box.

<b>both ....and</b> by paint containers essential	for this reason representing speakers
--	---

Good clear marking is \_\_\_\_\_ if the goods are not to go astray, and \_\_\_\_\_ marks are usually made \_\_\_\_\_ or dyes through a metal stencil. Wooden cases are sometimes marked by burned impressions in the wood itself.

We have some special instructions regarding manner of handling, loading, lifting, etc., and various warnings \_\_\_\_\_ for the owner's \_\_\_\_\_ the carrier's benefit.

In the past it very often happened that even clearly marked \_\_\_\_\_ were roughly handled or wrongly stored - simply because the stevedores loading or unloading them could not understand the directions and warnings! For this reason the practice has developed of stencilling symbols \_\_\_\_\_ warnings and directions: these can be understood by \_\_\_\_\_ of any language.

2. Translate the following sentences into Russian:

1. All boxes are to be marked as usual, but please number them consecutively from 1 to 11.

2. All marks other than our own and the name of country of origin are to be removed from the crates before shipment.

3. We attach a list of marks and numbers to the various packages. Please give great care to clear and correct marking.

4. Your instructions as to marking have been accurately carried out and the goods packed with all the care of our experienced despatch staff.

5. We are pleased to confirm that your instructions regarding packing and marking have been accurately executed by our forwarding agents in London.

---

## VII. AGREEMENT

*1. Read the agreement and replace the word combinations in brackets with the appropriate English equivalents given in the box.*

AGREEMENT - ORDER No.  
for automobile transportation services  
and international cargo shipment

according to the route as follows	on behalf of on the basis
The Closed Joint-Stock Company	present agreement
Carrier	provide
CRCT	request
Forwarding Agent	stipulated
hereinafter referred to as	transportation services
integral part	validity

(Закрытое акционерное общество) "Torgimpex", (здесь и далее именуемое как) the Forwarding Agent, represented by \_\_\_\_\_ on the one hand, and \_\_\_\_\_, hereinafter referred to as the Client, represented by \_\_\_\_\_, on the other hand, have concluded the (настоящее соглашение) (о нижеследующем):

### 1. Subject of the Agreement:

1.1. The (экспедитор) acting (на основании) of this agreement, as per the Client's order and at the Client's cost, shall (обеспечит) forward-

ing services for international and domestic cargo shipment using (**транспортные услуги**) of the (**Перевозчик**), i.e. organises shipment by hired transport (**согласно маршруту**) as indicated in the single (**запрос**). Such Request can be received by fax and is of the same (**законную силу**) with the original copy.

1.2. The Forwarding Agent and the Client act on their own or (**от имени**) other parties, which have concluded direct agreements with them.

1.3. The shipment shall be made in accordance with the "Convention on the Agreement on International Road Cargo Transportation (**КПДГ**)".

1.4. Detailed conditions of each shipment shall be (**оговариваются**) in the single request. The Client shall send such request to the Forwarding Agent after mutual approval. The request is an (**неотъемлемая часть**) of the agreement.

approve	legal
at the points of load/discharge	loading period
cargo	maximum load capacity
despatch/arrival	piled
discharge period	placement
dimensions	submit
in advance	volume
	weight

## 2. Responsibilities of the Client:

2.1. The Client shall (**представит**) full information on the proposed shipment at least 2 days (**заранее**), as follows:

2.1.1. The route of the proposed shipment quantity of packages (**в пунктах загрузки/выгрузки**) indicating country, city, postal code, street, building number, name of the organisation, date and time of (**отправки/прибытия**), contact person at the points of load/discharge, telephone and fax numbers);

2.1.2. Name of the (**груза**), cargo specifications (**объем, вес, размеры**), non- hazardous/hazardous indications, ADR class, can or cannot be (**штабилизирован**);

2.1.3. Total invoice cost of cargo shipped.

2.2. The Client shall load the vehicles in accordance with their (**максимальная грузоподъемность**) and (**разрешенные**) standards of those countries that they pass through.

2.3. During the loading the Client shall (**согласовать**) with the driver aspects of efficient (**размещение**) of cargo in the truck's body (platform).

2.4. The Client shall not allow more than 24-hour (twenty four) (**период загрузки**) or more than 48-hour (forty eight) (**период разгрузки**) for the Forwarding Agent's road vehicle.

ensure safe cargo transportation	mutually approved
destination point	properly issued
deliver the cargo	sealing
Forwarding Agent	unobstructed

### 3. Responsibilities of the Forwarding Agent:

3.1. The Forwarding Agent shall send the road vehicles to the Client in perfect technical condition to (**гарантировать безопасную транспортировку груза**). The vehicles shall have necessary means of (**пломбировки**) with leads.

3.2. The Forwarding Agent shall make sure that the drivers carry with them all (**должным образом оформленные**) documents for (**беспрепятственной**) shipment.

3.3. The Forwarding Agent shall bring the vehicles for loading to the address and on the time as indicated in the (**взаимно одобренный**) request for shipment.

3.4. (**Экспедитор**) shall (**доставит груз**) as per the request obtained, to the (**пункт назначения**) and hand it over to consignee.

account	margin
banking fees	payment
consignee	penalty
cargo	remuneration
delay	responsible
freight amount	stipulated

#### 4. Terms of payment:

4.1 The Forwarding Agent shall issue the bill to the Client to be paid as well the CMR marked by the (**грузополучателем**) on reception of (**груза**). The (**платеж**) shall be executed within 10 banking days after reception of documents.

4.2. The payment for the forwarding services is the amount of (**вознаграждение**), it shall remain on the Forwarding Agent's account being a (**зд. разница**) between the shipment's amount and the amount paid by the Forwarding Agent to the Carrier to the Carrier's account.

4.3 The amount (**оговоренный**) in the request shall be received on the (**счет**). The Client is held (**ответственный**) for payment of the (**банковские сборы**).

4.4 In the case of delayed payment the Client shall pay to the Forwarding Agent the (**штраф**) in the amount of 0.1 per cent of the (**сумма фрахта**) for each day of (**задержки**).

additional expenses	gross weight
allowable limit	idle period
appropriate expenses	improper
cargo insurance	insufficient
consignee	penalty
consignor	shall be responsible for
expenses to be borne by consignor	quantity

#### 5. Responsibilities of the Parties:

5.1. When the road vehicles are delivered for loading later than 24 hours or the cargo is not delivered to the (**грузополучатель**) in time (if the request indicates the delivery date) the Forwarding Agent shall pay penalty equal to the payment for (**простой**) (refer to p. 5.2).

5.2. If such idle period occurs on the route, when loading or discharging as the Client's fault and such period is longer than stipulated in para 2.4, the Client shall pay to the Forwarding Agent (**штраф**) for idle period of road vehicles in the amount of USD 100 (one hundred).

5.3. If the Client overloads the vehicle more than (допустимый предел), the Client shall pay to the Forwarding Agent all (дополнительные расходы) during shipment.

5.4. During transit transportation within the territory of Poland with convoy escort, the Client shall bear all (все соответствующие расходы) of the Forwarding Agent.

5.5. The Client (несет ответственность за) all expenses of the Forwarding Agent and losses caused to him as a result of (ненадлежащее) or (недостаточное) issue of the following:

-- instructions regarding name and address of (грузоотправитель), place and time of load/discharge of cargo, name and address of consignee, approved indication of cargo type and packing method, (количество) of packages, their marking and numbers, (вес брутто) of cargo;

-- all other instructions to be indicated (if necessary) in the request (reloading prohibited, (расходы, которые несет грузоотправитель), recommendations to the Forwarding Agent on (страховка груза), required transportation conditions, etc.);

-- instructions required for fulfillment customs and other formalities.

authorized body beyond their control Chamber of Commerce complete or partial failure	Force Majeure conditions fulfillment notify notification confirmed
---	--

## 6. Force Majeure Conditions:

6.1. Neither Party shall be responsible for (полный или частичный отказ) to fulfill obligations as per this Agreement if such failure is caused by forces (вне их контроля), such as flood, fire, earthquake, war, other acts of God, as well as decisions by governmental or other bodies that obstruct financial and business activities of the Parties and (выполнение) of this Agreement.

6.2. The Party that has encountered (обстоятельства непреодолимой силы) shall immediately (уведомлять) the other Party. Facts stated in the (уведомлении), shall be (подтверждены) by the (Торговая Палата) or another (уполномоченным органом) of that country.

authorised representatives	notification
binding	Party
amendments	signature
come into force	submitted
disputes and disagreements	terminate
fulfillment	valid
negotiations	validity period

## 7. Arbitration;

7.1. All disputes and disagreements that may appear during (**выполнения**) of the Agreement shall be resolved by (**переговоры**).

7.2. If such (**споры и разногласия**) cannot be resolved by negotiations, the matter shall be (**представлены**) to the Arbitration Court. Its decision shall be (**обязательны**) for the both Parties.

## 8. Final Provisions:

8.1. The present Agreement is made in two copies of the same validity, one for each Party.

8.2. All additions or (**поправки**) to the present Agreement shall be made in the written form and signed by the (**уполномоченные представители**) of the both Parties.

8.3. The present Agreement shall (**вступить в силу**) from the date of (**подписания**) and be (**действительный**) till December 31, 2012.

8.4. Any (**сторона**) has the right to (**аннулировать**) the present Agreement on its own without indication of reasons, with written (**уведомления**) of the other Party at least one month prior to termination date.

8.5. If one month before the expiry date of the present Agreement none of the Parties notifies another on readiness to terminate the Agreement, the (**период действия**) of the Agreement is considered extended for the next year.



*2. Translate the following sentences into Russian using the dictionary if necessary:*

1. The relations of the Forwarding Agent and the Customer are based upon the provisions of the Convention on the Contract for the International Carriage of Goods by Road (CMR), the Customs Convention on the International Transport of Goods under Cover of TIR Carnets.

2. The Forwarding Agent is required to inform the Customer about the forced delays of the vehicle on the road, breakdown or any other unexpected circumstances creating an obstacle for the delivery of the cargo in time, as well to agree all actions during the order execution.

3. The Customer provides the Forwarding Agent with guarantee that the cargo weight does not exceed the existing international standards, as well as standards set in the Republic of Belarus.

4. All expenses related to the forwarding of the cargo are included into the freight-rate and are negotiated by the parties when accepting the request.

5. In case the cargo has not been provided according to the finally agreed schedule, the Customer reimburses 10% of the freight rate amount of the cargo that was supposed to be forwarded.

6. The Forwarding Agent arranges the cargo transportation using vehicles in accordance with the approved schedule.

7. The Forwarding Agent (supported by the driver of the vehicle) is required to control the process of cargo loading/unloading and provides reasonable cargo stowage in order to avoid unequal distribution of weight to the axles of the vehicle.

8. The Forwarding Agent is required to inform the Customer about the forced delays of the vehicle on the road, breakdown or any other unexpected circumstances creating an obstacle for the delivery of the cargo in time.

9. In case of cargo loss, deficit or damage discovery, the Customer is required to inform the Forwarding Agent immediately and to arrange the documents in accordance with the legislation.

10. The Customer is required to inform the Forwarding Agent about necessary address changes for the vehicle, and to pay charges for additional run in accordance with agreed price.

11. Payment for the cargo transportation by vehicles is performed directly between the Customer and the Forwarding Agent by money order to the account of the Forwarding Agent in foreign currency. Bank charges are paid by the Customer. Currency of payment - euro.

12. The Forwarding Agent provides the Customer with the guarantee that all vehicles involved in the cargo transportation are functioning properly, that they are suitable for international cargo transportation purposes, and available in the amount and period agreed by the parties, as well as provides all necessary documents, including CMR insurance of the responsibilities of the Carrier.

13. Penalty provision payments do not release the Customer from its duties to pay the freight rate.

14. All changes and supplements to the present Contract are legally valid if submitted in written form and signed by both parties only.

---

*3. Translate the following sentences into English using the dictionary if necessary:*

1. Исполнитель и Заказчик выступают от своего имени и по поручению организаций, с которыми они имеют Договора.

2. На каждую отдельную перевозку оформляется транспортный заказ-заявка, который содержит следующие сведения: дата отгрузки; адрес загрузки и таможи отправления; адреса разгрузок и таможен назначения; наименование груза, его количество; срок доставки; фрахтовая ставка.

3. Заказчик обеспечивает погрузку/разгрузку и таможенное оформление транспортных средств Исполнителя в течение 48 часов с момента прихода транспортных средств к месту погрузки/разгрузки.

4. Экспедитор (исполнитель) информирует Заказчика о вынужденных задержках транспортных средств в пути следования, авариях и о других непредвиденных обстоятельствах, а также согласовывает все действия во время выполнения заказа.

5. Заказчик согласовывает с Исполнителем график отгрузок, гарантирует наличие всех необходимых документов (лицензий, гру-

зовых таможенных деклараций, сертификаты о происхождении товара и других документов).

6. Настоящий Договор вступает в силу с момента его подписания и будет действовать до ... июня 2015г.

7. В случае обнаружения утраты, недостачи, порчи груза Заказчик немедленно информирует Исполнителя и оформляет документы в соответствии с законодательством.

9. Оплата производится в течение 10 календарных дней с момента получения СМР- накладной с отметками грузополучателя о приеме груза.

10. Все споры и разногласия, которые могут возникнуть из исполнения настоящего договора, и не будут урегулированы путем переговоров, подлежат рассмотрению в соответствии с законодательством Республики Беларусь в Хозяйственном(Арбитражном) Суде Республики Беларусь.

11. Оплата штрафных санкций не освобождает Заказчика от оплаты фрахтовой ставки.

12. Исполнитель осуществляет перевозки грузов Заказчика автомобильным транспортом согласно утвержденному графику.

13. Все изменения и дополнения к настоящему Договору действительны лишь в том случае, если они совершены в письменной форме и подписаны обеими сторонами.

---

## VIII. INTERBUS AGREEMENT

*1. Read the text about Interbus Agreement carefully and be ready for a comprehension check-up.*

The Interbus Agreement on the international occasional carriage of passengers by coach and bus entered into force in the European Community on 1 January 2003. The Agreement applies to the international carriage of passengers, of any nationality, and to unladen journeys of the buses and coaches concerned with these services on the territory of the European Union (EU). The Interbus Agreement governs traffic not only between the Community and the non-EC countries but also between the non-EC countries themselves, thus establishing a degree of fiscal, social

and technical harmonisation in addition to market access rules. The Agreement also provides for accession by any member of the European Conference of Ministers of Transport. The Interbus Agreement replaces the bilateral agreements concluded between the contracting parties.

The Interbus Agreement incorporates most of the liberalisation measures while adding social, fiscal and technical measures based on the principle of non-discrimination between the various contracting parties. The principle of non-discrimination on grounds of nationality or the place of establishment of the transport operator, and of the origin or destination of the bus or coach should be considered to be a basic condition applying to the provision of international transport services.

The Agreement provides for uniform models for transport documents such as the control document for liberalised occasional services and also the authorisation and the application form for non-liberalised services in order to facilitate and simplify inspection procedures.

Buses and coaches are exempted from all vehicle taxes and charges levied on the circulation or possession of vehicles as well as from all special taxes or charges levied on transport operations in the territory of the other contracting parties. However, buses and coaches are not exempted from payment of taxes and charges on motor fuel, value added tax on transport services, road tolls and user charges levied on the use of infrastructure.

A Joint Committee is established, responsible for the management and proper application of the Agreement. In particular, the Committee is responsible for:

- drawing up, on the basis of the information provided by the contracting parties, a list of the authorities responsible for certain tasks provided for under the Agreement,
- amending or adapting the control documents and other models of documents established in the Annexes to the Agreement,
- amending or adapting the Annexes concerning the technical standards applicable to buses and coaches,
- drawing up a list, on the basis of information provided by the contracting parties, of all customs duties, taxes and charges,
- amending or adapting the requirements concerning the social provisions in order to incorporate future measures taken within the European Community,

- resolving any dispute over the implementation and interpretation of the Agreement,
- recommending further steps towards the liberalisation of those occasional services still subject to authorisation.

The Agreement is concluded for a period of five years, dating from its entry into force. The duration is automatically extended for successive periods of five years among those contracting parties who do not express their wish not to do so.

*2. Answer the following questions:*

1. When did the Interbus Agreement enter into force?
2. What does the Agreement apply to?
3. What does this Agreement govern?
4. What agreements does Interbus Agreement replace?
5. What does this Agreement provide for transport documents?
6. What is established for management and proper application of the Agreement?
7. For how long is this Agreement concluded?

*3. Complete the sentences according to the contents of the text.*

1. **The Interbus Agreement incorporates most of the ....**
2. **The principle of non-discrimination on grounds of nationality or the place of establishment of transport operator should be considered to be ....**
3. **Buses and coaches are exempted from ....**
4. **Joint Committee is established, responsible for ....**
5. **The Agreement is concluded for a period of five years, dating ....**
6. **The duration is automatically extended for ....**

*4. Skim the text again and find out what the Joint Committee is responsible for in particular.*

*5. Translate the following sentences from Interbus Agreement into Russian.*

1. This Agreement shall apply to the international carriage of passengers, of any nationality, by road by means of occasional services carried out by transport operators for hire or reward established in a Contracting Party in accordance with its law and holding a license to undertake carriage by means of international occasional services by coach and bus.

2. The use of buses and coaches designed to carry passengers for the transport of goods for commercial purposes shall be excluded from the scope of this Agreement.

**3. 'Shuttle services' are services whereby, by means of repeated outward and return journeys, previously formed groups of passengers are carried from a single place of departure to a single destination.**

4. Place of departure and destination shall mean, respectively, the place where the journey begins and the place where the journey ends, together with, in each case, the surrounding localities within a radius of 50 km.

**5. 'Contracting Parties' are those signatories that have consented to be bound by this Agreement and for which this Agreement is in force.**

**6. 'Transit' means the part of a transport operation through the territory of a Contracting Party without passengers being picked up or set down.**

7. Closed-door tours, that is to say services whereby the same bus or coach is used to carry the same group of passengers throughout the journey and to bring them back to the place of departure. The place of departure is in the territory of the Contracting Party in which the transport operator is established.

8. Passengers have been invited to travel into the territory of another Contracting Party, the cost of transport being borne by the person issuing the invitation. Such passengers must constitute a homogeneous group, which has not been formed solely with a view to undertaking that particular journey and which is brought into the territory of the Contracting Party in which the transport operator is established.

9. This Agreement shall enter into force for the Contracting Parties that have approved or ratified it, when four Contracting Parties including the European Community have approved or ratified it, on the first day of the third month following the date on which the fourth instrument of ap-

approval or ratification is deposited, or even on the first day of the sixth month, under condition in the latter case that a corresponding declaration be made at the time of the ratification of the Agreement.

10. This Agreement shall enter into force, for each Contracting Party that approves or ratifies it after the entry into force provided for in paragraph 1, on the first day of the third month following the date on which the Contracting Party concerned has deposited its instrument of approval or ratification.

11. After its entry into force, this Agreement shall be open to accession by countries which are full members of the European Conference of Ministers of Transport (ECMT).

12. For services provided by transport operators established within the European Community, the points of departure and/or destination of the services can be in any Member State of the European Community, independently of the Member State in which the bus or coach is registered or the Member State in which the transport operator is established.

13. Buses and coaches that are engaged in transport operations in accordance with this Agreement shall be exempted from all vehicle taxes and charges levied on the circulation or possession of vehicles as well as from all special taxes or charges levied on transport operations in the territory of the other Contracting Parties.

14. Contracting Parties shall ensure that tolls and any other form of user charges may not be imposed at the same time for the use of a single road section. However, Contracting Parties may also impose tolls on networks where user charges are levied, for the use of bridges, tunnels and mountain passes.

15. The passenger waybill shall be completed in duplicate by the transport operator for each journey before the start of the journey.

16. The competent authorities of the Contracting Party in whose territory the place of departure is situated shall examine the application for authorisation of the service concerned and, in the case of its approval, shall forward it to the competent authorities of the Contracting Party(ies) of destination as well as the competent authorities of the Contracting Parties in transit.

17. The competent authorities of the Contracting Party(ies) whose agreement has been requested shall issue the authorization within one month, without discrimination as to the nationality or place of establish-

ment of the transport operator. If these authorities do not agree on the terms of the authorization they shall inform the competent authorities of the Contracting Party(ies) concerned of the relevant reasons.

18. The competent authorities of two or more Contracting Parties may agree to simplify the authorisation procedure, the model of application for authorisation and the model of authorization for the occasional services carried out between these Contracting Parties.

19. The Contracting Parties shall take the measures necessary to enforce any decisions adopted by the Joint Committee in accordance, where necessary, with their own internal procedures.

20. The provisions of this Agreement shall replace those relevant provisions of the agreements concluded between Contracting Parties. As far as the European Community is concerned, this provision applies to agreements concluded between any Member State and a Contracting Party.

21. This Agreement shall be approved or ratified by the signatories in accordance with their own procedures.

22. In order to facilitate the management of this Agreement, a Joint Committee is hereby established. This Committee shall be made up of representatives of the Contracting Parties.

23. The Joint Committee shall in particular amend or adapt the control documents and other models of documents established in the Annexes to this Agreement.

---

## IX. TERMS AND DEFINITIONS

*1. Match the terms from the box with the appropriate definition.*

regular transit bus service	permit
vehicle	regular bus service
quotes	shuttle service
Carrier	closed-door service (tourist transport)
transit transport	



1. The term " \_\_\_\_\_ " means any physical or juridical person authorized to carry passengers and goods in conformity with the laws, regulations and rules of the Contracting Parties.

2. The term " \_\_\_\_\_ " means any power driven road vehicle built either for carriage of passengers (more than eight seats excluding the driver's seat) or goods or drawing such vehicles, or a combination comprising a vehicle and a trailer or a semi-trailer connected to it, built for the carriage of passengers or goods.

3. The term " \_\_\_\_\_ " means all kinds of permits to be issued by the competent authorities of the Contracting Parties.

4. The term " \_\_\_\_\_ " means the number of permits issued annually for transit purposes.

5. The term " \_\_\_\_\_ " means the carriage of passengers between the territory of the two Contracting Parties on a prescribed road in accordance with national schedules and tariffs.

6. The term " \_\_\_\_\_ " means a regular bus service beginning in the territory of one Contracting Party, crossing the territory of the other Contracting Party without leaving or taking passengers and terminating in the territory of a third State.

7. The term " \_\_\_\_\_ " means an organized international service for the carriage from one and the same point of departure to a fixed point of destination of a group of passengers and their return to the point of departure at the end of a pre-scheduled period. (Passengers traveling in group, are all required to return in the same group. The first return journey from and the last journey to the point of destination will be without passengers.)

8. The term " \_\_\_\_\_ " means international carriage of one and the same group of passengers in one and the same vehicle in a tour, starting from a point in the territory of one of the Contracting Parties and terminating in the same Contracting Party without taking or leaving passengers.

9. The term " \_\_\_\_\_ " means carriage of passengers and goods through the territory of one Contracting Party, between points of departure and destination located outside the territory of that Contracting Party.

2. Choose the right continuation of each sentence.

1. A transit permit shall be valid for one round trip transit journey...	a. ... to facilitate, simplify and accelerate the customs and other formalities relating to carriage of passengers and goods.
2. It shall also be valid for one vehicle and only for the carrier to whom...	b. ... unless either Contracting Party expresses its wish in writing to the other Contracting Party to terminate it at least three months prior to the date of expiry.
3. Arms, ammunitions and military equipment and explosives are excluded from the right of transit unless ...	c. ... through the territory of the Contracting Parties
4. The Contracting Parties shall take all the measures in order...	d. ... the Convention on the International Transport of Goods under cover of TIR Carnets and/or national laws and regulations.
5. An unloaded vehicle registered in one Contracting Party shall not enter...	e. ... any kind of insurance complying with the laws and regulations.
6. The transit tourist carriage and shuttle service to be performed by a vehicle registered in the territory of one Contracting Party to or from the territory of the other Contracting Party...	f. ... the other Contracting Party with reports and results of the inquiry and other necessary information.
7. The International transport of goods by road in accordance with this Agreement shall be subject to the requirements of...	<b>g. ... it is issued and shall not be transferable.</b>
8. Fuel contained in the standard	h. ... the territory of the other Con-

tanks of vehicles shall be exempt from...	tracting Party to collect passengers and goods unless permit is issued for this purpose.
9. All carriages to be performed in accordance with this Agreement shall be covered by...	i. ... laws and regulations governing the road traffic of the other Contracting Party.
10. In cases of accidents, breakdowns or other difficulties, the competent authorities of the Contracting Party in whose territory such an incident occurs, shall provide...	j. ... a permit is obtained from the Contracting Parties.
11. Carriers and crew of the vehicles registered in one Contracting Party shall comply with...	k. .... customs duties and all other taxes and duties. The standard tank is of vehicles.
12. This Agreement shall be automatically renewed for period of one year...	l. ... shall not be subject to obtaining permit.

## X. TRANSPORTATION AGREEMENT

*1. Mind the following adverbs found in the text.*

1. hereafter	<b>впредь, в дальнейшем</b>
2. hereat	<b>в результате этого</b>
3. hereby	<b>настоящим, этим; таким образом</b>
4. herein	<b>здесь, в этом (документе)</b>
5. hereinabove	<b>вышеупомянутый, вышеназванный</b>
6. hereinafter	<b>ниже; в дальнейшем в этом документе</b>

7. hereinbefore	ВЫШЕ (в данном документе)
8. hereof	ОТСЮДА, ИЗ ЭТОГО (в документах)
9. hereto	К ЭТОМУ (документу)
10. hereunder	В СООТВЕТСТВИИ С НАСТОЯЩИМ ДОГОВОРом
11. thereafter	С ЭТОГО времени, после этого, затем

*2. This is an example of a transportation agreement. Read it attentively and translate into Russian using a dictionary if necessary.*

This Agreement is entered into this \_\_\_ day of \_\_\_\_\_, 20011 by and between \_\_\_\_\_ ("CARRIER") whose principal place of business is located at \_\_\_\_\_ and Propak Logistics, Inc. ("PROPAK"), whose principal place of business is 4001 Planters Road, Fort Smith, Arkansas 72908.

PROPAK is a logistics company and broker of motor carrier transportation services duly licensed by the United States Department of Transportation (ICC MC# 387908 B). From time to time, shipments of property provided by PROPAK'S customers ("SHIPPER") require the services of a motor carrier for the purpose of transporting commodities between points in the continental United States;

CARRIER is engaged in the transportation of property by motor vehicle, and is duly licensed by the United States Department of Transportation as a contract carrier (ICC MC # \_\_\_\_\_), and;

PROPAK desires to engage the services of CARRIER to arrange the transportation of SHIPPER'S goods as set forth on any and all Load Confirmation Sheets and/or bills of lading, which shall hereinafter be referred to as "Load Sheet."

In consideration of the premises and mutual benefits to be derived by CARRIER and PROPAK from this Agreement and the mutual promises made and exchanged, CARRIER and PROPAK agree as follows:

1. Carrier's Operating Authority and Compliance with Law: CARRIER represents and warrants that it is duly and legally qualified to provide, as a contract carrier, the transportation services contemplated herein. CARRIER further represents and warrants that it does not have a conditional or unsatisfactory safety rating issued from the U.S. Department of Transportation, and further agrees to comply with all federal, state, and local laws regarding the provision of the transportation services contemplated under this Agreement.

2. Performance of Services: CARRIER agrees, subject to availability and legal loading capacity of its equipment, to transport commodities and perform ancillary services tendered to it by PROPAK in accordance with the shipping instructions as set forth in each Load Sheet. CARRIER agrees that it will use only tractors, trailers and other equipment which are in good condition and are clean, sound and free from odors, moisture and other conditions that might result in loss or damage to or adverse effect upon the goods transported. CARRIER and PROPAK agree that each shipment to be transported under this Agreement will be evidenced by a separate Load Sheet, which Load Sheet will become a part of this Agreement when CARRIER accepts a shipment and commences the movement of freight.

3. Rates and Charges: PROPAK will compensate CARRIER for the transportation services performed hereunder on the basis of rates and charges set forth on each Load Sheet. CARRIER must provide a completed invoice together with all of the signed original bill(s) of lading, signed pickup receipts and signed proof of delivery receipt(s) for each shipment included on the invoice. PROPAK shall remit payment to CARRIER for each load tendered within thirty (30) days of receipt by PROPAK of all properly executed paperwork for the load, as determined solely by PROPAK. PROPAK is responsible for all payments to CARRIER for all services rendered by the CARRIER. CARRIER shall not look to SHIPPER for payment and SHIPPER'S payments for services rendered will always be made directly to PROPAK. CARRIER must maintain with PROPAK at all times during which a load is being transported; a copy of its operating authority showing it to be a contract carrier, certificates of insurance in effect as of the date of each shipment, all forms required by the IRS and a signed Transportation Agreement. Fail-

ure to provide these documents will result in delays in the payment of all invoices from the CARRIER.

4. Effective Date and Term: This Agreement shall go into effect on the day and year herein above written and remain in effect for a period of one (1) year from date hereof, and shall renew automatically for one (1) year periods thereafter, subject to the right of either party hereto to cancel or terminate the Agreement upon not less than thirty (30) days written notice of one party to the other prior to the end of the then current term, with notice being effective upon delivery.

5. Confidentiality: Carrier agrees that it will not divulge to any third party (a) the terms of this Agreement, or (b) any proprietary information derived in the course of performance of this Agreement CARRIER specifically agrees that it shall not reveal the terms on which it provides transportation to any third party represented by PROPAK and/or the consignee/consignors of any shipment moving hereunder.

6. Sub-Contract Prohibition: CARRIER specifically agrees that all freight tendered to it by PROPAK shall be transported on equipment operated only under the authority of CARRIER, and that CARRIER shall not in any manner sub-contract, broker, or in any other form arrange for the freight to be transported by a third party without the prior written consent of PROPAK.

7. Insurance: CARRIER shall maintain insurance policies in force at all times that cover personal liability, property damage and cargo damage, as well as all coverage required under applicable state and/or federal law, including workers' compensation coverage.

CARRIER will provide PROPAK with a Certificate of Insurance of each policy in force showing PROPAK as certificate holder and containing a clause which provides that PROPAK will be given thirty (30) days written notice prior to the effective date of any cancellation or material change in said policy(ies).

8. Loss, Damage or Destruction of Cargo: CARRIER shall be liable for any loss, damage or destruction of any property transported under this Agreement. If any property is lost, damaged or destroyed, in whole or in part, SHIPPER or PROPAK will submit a written claim to CAR-

RIER and CARRIER shall pay the claim within thirty (30) days. CARRIER agrees, in case of accident, to use the utmost care and diligence in the protection of the property.

9. Chargebacks: CARRIER agrees that it will be responsible for any SHIPPER or customer chargebacks resulting from late deliveries or missed appointments provided. CARRIER is notified at time of load tender that penalties will be in effect and the specific amounts of any penalties for late delivery or missed appointment as agreed to in the load sheet, excluding acts of God, terrorism, war, accidents, breakdown, or any circumstances beyond carrier's control.

10. Accident or Breakdown Notification: CARRIER agrees to notify PROPAK by telephone immediately of any accident or breakdown which impairs or delays the movement of any property under this Agreement.

11. Indemnification: CARRIER shall indemnify and hold harmless SHIPPER and PROPAK from and against any and all claims, demands, direct or indirect damages, causes of action, liabilities, losses, suits, taxes, penalties and fines from any source caused by or resulting from the action or omission of CARRIER or its agents or employees in providing transportation services under this Agreement or in failing to comply with any law(s) and regulation(s) with respect to the maintenance, operations and use of motor vehicles and equipment hereunder.

12. Conflicts: In the event there is a conflict between the terms of this Agreement and the bill of lading, the provisions of this Agreement shall govern.

13. Governmental Regulations: PROPAK and CARRIER hereby mutually agree and stipulate that each is familiar with all governmental regulations, that each will fully comply with said regulations, and that said duty of compliance shall at all times during the term of this Agreement be a material provision and obligation of each to the other. Consistent with said regulatory requirements, CARRIER agrees to provide PROPAK all documents and information which PROPAK is required to have on file and which are normally within the possession of CARRIER.

14. Independent Contractor Relationship: CARRIER shall have the exclusive right to employ or discharge all persons required in the performance of the services contemplated hereunder and such persons shall be and remain employees or agents of CARRIER at all times.

15. Severability: If any provision of this Agreement is found to be invalid or unenforceable, the remaining provisions shall survive in full force and effect and shall constitute the full Agreement between CARRIER and PROPAK.

16. Entire Agreement and Modifications: This Agreement including all schedule(s) attached hereto constitutes the entire Agreement between the CARRIER and PROPAK with respect to the subject matter of this Agreement and may not be modified or amended unless accomplished by writing, signed by both CARRIER and PROPAK and no provision or requirement in this contract shall be considered waived unless a waiver is expressly endorsed hereon or attached hereto.

In witness where of, the undersigned individuals have executed this Agreement the day and year herein above written, and by doing so, represent and warrant that they accept and agree to the terms contained herein and have been or are specifically authorized to do so on behalf of the organization they represent.

*3. Fill in the gaps with the appropriate words and word combinations from the box. Translate the sentences into Russian.*

agreement, cargo damage, contemplated, the terms, damage, property, penalties, responsible for, chargebacks, deliveries, to notify, liable for, indemnify, breakdown, delays, warrants, proprietary information, bill of lading, claims, liabilities, suits, the terms, the provisions, divulge, stipulate, governmental regulations, insurance policies, cover, invoice, receipt, remit, provision
---

1. Carrier represents and \_\_\_\_\_ that it does not have a conditional or unsatisfactory safety rating, and agrees to comply with all federal, state, and local laws regarding the \_\_\_\_\_ of the transportation services \_\_\_\_\_ under this Agreement.



2. Carrier agrees that it will not \_\_\_\_\_ to any third party \_\_\_\_\_ of this Agreement, or any \_\_\_\_\_ derived in the course of performance of this Agreement.

3. CARRIER shall be \_\_\_\_\_ any loss, \_\_\_\_\_ or destruction of any \_\_\_\_\_ transported under this Agreement.

4. CARRIER agrees that it will be \_\_\_\_\_ any SHIPPER or customer \_\_\_\_\_ resulting from late \_\_\_\_\_ or missed appointments provided.

5. CARRIER agrees \_\_\_\_\_ PROPAK by telephone immediately of any accident or \_\_\_\_\_ which impairs or \_\_\_\_\_ the movement of any property under this \_\_\_\_\_.

6. CARRIER shall \_\_\_\_\_ and hold harmless SHIPPER and PROPAK from and against any and all \_\_\_\_\_, demands, direct or indirect damages, causes of action, \_\_\_\_\_, losses, \_\_\_\_\_, taxes, \_\_\_\_\_ and fines from any source.

7. In the event there is a conflict between \_\_\_\_\_ of this Agreement and the bill of lading, \_\_\_\_\_ of this Agreement shall govern.

8. PROPAK and CARRIER hereby mutually agree and \_\_\_\_\_ that each is familiar with all \_\_\_\_\_, that each will fully comply with said regulations.

9. CARRIER shall maintain \_\_\_\_\_ in force at all times that \_\_\_\_\_ personal liability, property damage and \_\_\_\_\_, as well as all coverage required under applicable state and/or federal law.

10. CARRIER must provide a completed invoice together with all of the signed original \_\_\_\_\_, signed pickup receipts and signed proof of delivery receipt for each shipment included on the \_\_\_\_\_.

11. PROPAK shall \_\_\_\_\_ payment to CARRIER for each load within 30 days of \_\_\_\_\_ by PROPAK of all properly executed paperwork for the load.

#### *4. Fill in the gaps with the necessary prepositions.*

1. \_\_\_\_\_ time to time, shipments \_\_\_\_\_ property provided \_\_\_\_\_ PROPAK'S customers require the services of a motor carrier \_\_\_\_\_ the purpose of transporting commodities \_\_\_\_\_ points in the continental United States.

2. CARRIER agrees that it will use only tractors, trailers and other equipment which are \_\_\_\_\_ good condition and are clean, sound and free \_\_\_\_\_ odors, moisture and other conditions that might result \_\_\_\_\_ loss or damage to or adverse effect \_\_\_\_\_ the goods transported.

3. CARRIER will provide PROPAK \_\_\_\_\_ a Certificate of Insurance \_\_\_\_\_ each policy in force and containing a clause which provides that PROPAK will be given 30 days written notice \_\_\_\_\_ the effective date of any cancellation or material change in said policy.

4. CARRIER agrees to notify PROPAK \_\_\_\_\_ telephone immediately \_\_\_\_\_ any accident or breakdown which impairs or delays the movement \_\_\_\_\_ any property \_\_\_\_\_ this Agreement.

5. PROPAK is responsible \_\_\_\_\_ all payments \_\_\_\_\_ CARRIER \_\_\_\_\_ all services rendered \_\_\_\_\_ the CARRIER.

6. CARRIER specifically agrees that it shall not reveal the terms \_\_\_\_\_ which it provides transportation \_\_\_\_\_ any third party represented \_\_\_\_\_ PROPAK.

7. CARRIER shall be liable \_\_\_\_\_ any loss, damage or destruction \_\_\_\_\_ any property transported \_\_\_\_\_ this Agreement.

8. \_\_\_\_\_ the event there is a conflict \_\_\_\_\_ the terms \_\_\_\_\_ this Agreement and the bill \_\_\_\_\_ lading, the provisions \_\_\_\_\_ this Agreement shall govern.

9. This Agreement constitutes the entire Agreement \_\_\_\_\_ the CARRIER and PROPAK \_\_\_\_\_ respect to the subject matter \_\_\_\_\_ this Agreement and may not be modified or amended unless accomplished \_\_\_\_\_ writing, signed \_\_\_\_\_ both CARRIER and PROPAK.

10. CARRIER agrees that it will be responsible \_\_\_\_\_ any SHIPPER or customer chargebacks resulting \_\_\_\_\_ late deliveries or missed appointments

*5. Here are some useful phrases connected with the transportation insurance. Match them with their Russian equivalents.*

1. The buyer (seller) bears the risk for the transport of the goods.	a. <b>За время перевозок товары застрахованы от утери и /или повреждения.</b>
2. During transportation the goods are insured against loss	b. <b>Если Вы потребуете, мы застрахуем данные товары за</b>

and / or damage.	Ваш счёт.
3. The risk of loss or damage will be carried by us (you).	с. Транспортная страховка может быть заключена за Ваш счёт
4. The goods are insured while in transit.	d. До прибытия в место назначения товары застрахованы от утери или повреждения.
5. We insure the goods at our (your) cost against damage in transport.	е. Покупатель (продавец) несёт риск, связанный с транспортировкой товара
6. We (you) pay the transport insurance.	f. Стоимость страховки (не)включена в цену наших товаров.
7. The goods are insured against loss or damage until they arrive at destination.	g. Мы застрахуем товары от повреждения в пути за наш (Ваш) счёт.
8. Cost of insurance is split equally between customer and seller.	h. Транспортная страховка оплачивается нами (Вами).
9. According to your request we took out a transportation insurance policy and will charge same to you.	i. Стоимость страховки делится поровну между продавцом и покупателем.
10. Should you so desire, we shall insure these goods at your cost.	j. Риски, связанные с утерей и повреждениями, несём мы (несёте Вы).
11. A transport insurance can be taken out, the cost of which we will charge to you.	к. Товары застрахованы на время пребывания в транзите.
12. Cost of insurance is (not) included in our price of goods.	l. Соответственно Вашим требованиям, мы заключили страховку по перевозке и расходы перекладываем на Вас.

## XI. STANDARD CONDITIONS OF CARRIAGE

1. Choose for each sentence in English the appropriate variant in Russian.

<p>1. "Carrier" means the party who has undertaken to perform or to procure the performance of the entire transport from the place of receipt or port of loading to the port of discharge or place of delivery.</p>	<p>a. Когда перевозчик несёт ответственность за компенсацию относительно потери или повреждения груза, такая компенсация должна быть вычислена по отношению к стоимости такого груза на месте и во время его доставки грузополучателю в соответствии с контрактом перевозки или когда он должен быть поставлен.</p>
<p>2. All liability of the Carrier shall cease unless suit is brought within nine months after delivery of the Goods or the date when the Goods should have been delivered.</p>	<p>b. Опасные грузы должны быть удалены из порта разгрузки, как только это практически осуществимо, если только конкретное разрешение не было получено для того, чтобы груз остался в порту.</p>
<p>3. The Carrier is entitled to perform the transport in any reasonable manner and by any reasonable means, methods and routes.</p>	<p>d. Вся ответственность перевозчика прекращается, если иск не будет предъявлен в течение 9 месяцев после поставки товара или даты, когда товар нужно было поставить.</p>
<p>4. The Carrier shall be liable for loss of or damage to the Goods occurring between the time when he receives the Goods into his charge and the time of delivery.</p>	<p>c. Перевозчик имеет право выполнять перевозки любым подходящим путём и любыми подходящими средствами, методами и маршрутами.</p>

<p>5. When the Carrier is liable for compensation in respect of loss of or damage to the Goods, such compensation shall be calculated by reference to the value of such Goods at the place and time they are delivered to the Merchant in accordance with the Contract of Carriage or should have been so delivered.</p>	<p>е. «Перевозчик» - означает сторону, которая обязалась выполнить или обеспечить работу всего транспорта от места получения или порта погрузки к порту разгрузки или месту поставки.</p>
<p>6. Freight shall be deemed earned on receipt of the Goods by the Carrier and shall be paid in any event and is non-returnable.</p>	<p>ф. Перевозка товаров, попадающая под действие Базельской конвенции о контроле за трансграничной перевозкой опасных отходов и их удалением (Базельская конвенция от 28 марта 1989 года) выполняется только при условии предварительного согласования такой перевозки Перевозчиком.</p>
<p>7. The Merchant's attention is drawn to the stipulations concerning currency in which the freight and charges are to be paid, rate of exchange, devaluation and other contingencies relative to freight and charges in the relevant tariff conditions.</p>	<p>г. Перевозчик должен нести ответственность за потерю или повреждение груза, имеющих место между временем, когда он получил груз под свою ответственность, и временем его доставки.</p>
<p>8. In the event of increase in price for fuel oil, all freight rates may be adjusted in order to compensate the Carrier for increased fuel and lubricating costs as from the day of such increase.</p>	<p>h. Фрахт считается заработанным при получении товара перевозчиком и должен быть оплачен и не подлежит возврату.</p>
<p>9. Dangerous Goods must be removed from the port of discharge</p>	<p>i. В случае повышения цен на топливо, все ставки тарифов</p>

<p>as soon as is practicable unless specific permission has been obtained for the Goods to remain in the port.</p>	<p>могут быть скорректированы, с тем чтобы компенсировать перевозчику увеличение расходов на горюче-смазочные материалы со дня такого увеличения.</p>
<p>10. The Transport of Goods covered by the Basel Convention on the Control of Transboundary Movements of Hazardous Wastes and their Disposal (Basel Convention on 22 March 1989) is only carried out subject to prior approval of such a carriage from the Carrier.</p>	<p>j. Внимание грузополучателя обращается на соглашение относительно валюты, в которой фрахт и сборы должны быть выплачены, валютный курс, девальвацию, и другие непредвиденные расходы относительно фрахта и сборов при соответствующих тарифных условиях.</p>

---

## XII. VOCABULARY

1. ail – **беспокойство** (syn. worry, trouble)
2. ancillary - **вспомогательный, добавочный, подсобный; подчинённый**
3. ancillary industries — **вспомогательные отрасли промышленности**
4. ADR class – **класс опасности по соглашению ДОПГ- перевозка опасных грузов**
5. to be engaged in - **заниматься чем-л., быть занятым чем-л**
6. breakdown - **поломка механизма, машины; авария**
7. chargeback - **возвратный платеж, (операция по списанию ранее начисленных средств; отмена зачисления средств на счет клиента финансового учреждения в том случае, когда предъявленный им чек по тем или иным причинам не был оплачен банком)**
8. to comply with – **удовлетворять, соответствовать чему-либо**
9. consignee - **грузополучатель, консигнатор**
10. consignment - **1) коносамент, транспортная накладная 2) партия груза, груз 3) консигнационная отправка товаров**
11. consignor - **грузоотправитель**

12. consistent with - в соответствии
  13. to contemplate - 1) ставить целью, иметь намерением что-л. 2) рассматривать 3) предполагать 4) предусматривать
  14. diligence - 1) прилежание, старание, старательность, усердие, 2) внимательное отношение, заботливость, осмотрительность (*юрид*)
  15. to divulge - разглашать, раскрывать, обнародовать
  16. to exempt from taxes — освобождать от налогов
  17. fee - 1) вознаграждение; гонорар 2) пошлина; денежный сбор;  
**взнос**
  18. to impair -ухудшать; повреждать, портить
  19. indemnification - возмещение вреда, ущерб, компенсация
  20. in triplicate – в трех экземплярах
  21. IRS (Internal Revenue Service) - Внутренняя налоговая служба (США)
  22. to levy – взимать налог, облагать налогом
  23. lien - 1) право наложения ареста на имущество должника; право удержания, 2) залоговое право
  24. to pile –штабелировать
  25. provision - условие, постановление, положение (договора, закона)
  26. proprietary information - 1) информация, являющаяся собственностью фирмы 2) секрет фирмы
  27. regulatory requirement - законное требование
  28. to reimburse – возмещать, компенсировать, покрывать (сумму)
  29. to remit - переводить деньги
  30. to set forth – предлагать, формулировать, излагать
  31. severable - делимый; частичный
  32. shipment - 1) груз; партия товара 2) погрузка; отправка (товаров)
  33. to solicit - просить, ходатайствовать
  34. solicitation - 1) ходатайство, просьба 2) ведение дел (об адвокате)
  35. to stipulate - обуславливать, оговаривать, договариваться
  36. suit - *юрид.* процесс, тяжба
  37. validity - юридическая сила, юридическая действительность, законность, юридическое действие
  38. waiver - 1) отказ (от права, требования, привилегии) 2) документ (об отказе от права)
-

## PART II

*This is an example of a letter. Study carefully its structure.*

### Salutation

*Dear Sirs:* if you are writing to a company or organization

*Dear Sir/Madam:*

if you know the position, but not the name

*Dear (name):* if you **know the person's** name

Common titles

*Mr.* for men

*Mrs.* for married women

*Miss* for unmarried women

*Ms* for women, if **you don't know or** prefer not to specify marital status

FAR EASTERN AIRWAYS COMPANY LIMITED  
Regent House, 5<sup>th</sup> floor  
12/16 Haymarket, London W1V 5BX  
Administration: 020 7285 9981  
Reservations: 020 7564 0930  
Fax: 020 7285 9984

Mr. Roberto Garcia  
Universal Imports  
28 Whitechapel Court  
London E10 7NB

15 February 2000

Dear Mr. Garsia

Re: Roxanna Garbey

Roxanna Garbey has been accepted for a position as Passenger Service Agent with Far Eastern Airways at Gatwick Airport.

In order for Roxanna to work at Gatwick, she must have a special PASS which would permit her to visit high security areas. She has given your name as a reference.

I would appreciate it if you could complete the enclosed form and return it to us as quickly as possible. She is due to start work with us on 15 March, but can only do so after we receive your reference.

Thank you for your cooperation. I enclose a stamped addressed envelope.

Yours sincerely

### Common abbreviations

*Re.* regarding

*pp.* (on behalf of) when you sign the letter for someone else

*encs.* documents are enclosed with the letter

### Endings

*Yours sincerely* if you know the **person's name**

*Yours faithfully* if **you don't know the person's name**



J.P. Dent  
Personnel Manager

Sign the letter, then print your name and position under your signature.



## 1. SIMPLE ENQUIRY

*Fill in the gaps with the appropriate word combination from the box.*

buying in stock	newly-established
currently in the process	to good standard
demonstration version	quantity discounts
export prices	substantial share of the market
for delivery	supply
grateful	

25 November 20..  
United Kingdom

Dear Sirs,

We are a \_\_\_\_\_ firm specializing in the \_\_\_\_\_ of gardening equipment. As we are \_\_\_\_\_ of \_\_\_\_\_ in good time for the coming spring season, we would be \_\_\_\_\_ if you would send us a catalogue of your full lawn- mower range, both mechanical and electric. We would be most interested in receiving a \_\_\_\_\_.

Would you also indicate how much time should be allowed \_\_\_\_\_ and include details of your \_\_\_\_\_ and \_\_\_\_\_. Please also state whether goods on a sale or return basis can be supplied and what your position on after- sales service is.

We look forward to receiving your comments on this matter, together with details of on-site after sales service and up-date facilities, should you feel that your product will pass the test we intend it to undergo.

If your products are \_\_\_\_\_ and delivery is prompt, we feel sure that there will be ample opportunity for your company to acquire a \_\_\_\_\_ here.

Yours faithfully  
Thomas Wolf  
Assistant Manager

### Vocabulary

after sales service – служба работы с покупателями

be to good standard – соответствовать должному стандарту

buy in stock – создавать складские запасы

on-site – на месте

range – ассортимент

sale or return – покупка с правом возврата

---

## 2. OFFER

*Fill in the gaps with the appropriate word combination from the box.*

business contacts	per shipment
can be modified	revitalise
conforms to	sole UK agents
contact	subject to
have been approached by	a market economy
In this respect	trading service
mutual business associate	to strengthen
packaging	major contracts
per month	will be printed

Lancashire Enterprises plc

LONDON

12 December 20..

Dear Sirs,

### SINGLE USE TRANSFUSION SET

We were given your name by our \_\_\_\_\_, *Neil Smith* at Medical Systems (International) Ltd, who recommended that we \_\_\_\_\_ you.

Lancashire Enterprises plc is actively involved in Eastern Europe, having won \_\_\_\_\_ to help \_\_\_\_\_ the industrial base of countries effecting the transition to \_\_\_\_\_. Included in this work is the provision of a \_\_\_\_\_.

\_\_\_\_\_we \_\_\_\_\_ a Polish manufacturer of *Single Use Transfusion Sets* (sample enclosed), who has requested us to seek \_\_\_\_\_ in Western Europe on his behalf.

As \_\_\_\_\_ for the manufacturer, we are able to supply you the sets at a **CIF unit price of £ ... We are able to supply 8500 units \_\_\_\_\_ and** up to three shipments \_\_\_\_\_.

The manufacturing process used \_\_\_\_\_ international standards. The manufacturer is in the process of applying for the Department of Health certificate and would welcome an order \_\_\_\_\_ obtaining such certification.

In addition, if a good response from UK firms is forthcoming, the \_\_\_\_\_ will be modified and the instructions \_\_\_\_\_ in English.

Furthermore, should you so require, the product \_\_\_\_\_ to suit individual requirements.

We look forward to your response and would welcome an opportunity \_\_\_\_\_ ties with Eastern Europe. We also enclose for your information a brochure describing our activities in this field in more detail.

Yours faithfully  
Project Executive

### *Vocabulary*

business associate – деловой партнер

be forthcoming – следовать, последовать

effect the transition to – осуществлять переход к чему-либо

plc = public limited company- акционерное общество

provision – здесь: снабжение

sole agent – эксклюзивный представитель

subject to – при условии (если), при соблюдении

win major contracts – получить доступ к более крупным заказам

---

### 3. COMPLAINT

*Fill in the gaps with the appropriate word combination from the box.*

contain	prime quality
---------	---------------

in hand  
in question  
look forward to  
oversight on your part

replacements  
to keep to production schedules  
unsatisfactory  
unsuitable

7 December 20..  
Turnpike Traders Ltd  
BLACKBURN

Dear Sirs,

This morning we took delivery of the 50 boards of \_\_\_\_\_ timber ordered as per our letter of 1 November.

The quality of 2 of the boards is, however, \_\_\_\_\_ as they \_\_\_\_\_ large, unsightly knots rendering them \_\_\_\_\_ for use.

We feel sure that this is an \_\_\_\_\_ but, owing to the considerable number of orders \_\_\_\_\_, we had no alternative but to return the goods \_\_\_\_\_ to you, carriage forward, on the assumption that you will arrange for replacements to be sent to us by return to enable us \_\_\_\_\_.

We trust that you will be in agreement with this course of action and \_\_\_\_\_ receiving \_\_\_\_\_ corresponding to your otherwise high standards.

Please fax us your reply at your earliest convenience.

Yours faithfully  
WELLING & BURBURY LIMITED  
William Welling  
Chief Executive

### *Vocabulary*

by return – с обратной почтой, срочно

carriage forward – перевозка за счет покупателя, с неоплаченной перевозкой

order in hand – настоящий заказ

oversight - недосмотр

prime quality – первого сорта

unsightly – невзрачный

#### 4. INFORMATION FOR A CUSTOMER

*Fill in the gaps with the appropriate word combination from the box.*

descriptive literature	letter of credit
financial standing	samples
In the meantime	stipulate
in the region of	With reference to

28 April 20..  
Belgium  
Fax: 00 32 56 773058

Dear Sir or Madam

*RE: SOURCING GINSENG ROOTS*

\_\_\_\_\_ our fax of 22 April please note that our contacts in China have just confirmed that small \_\_\_\_\_ and \_\_\_\_\_ have been despatched. As soon as we receive this material we will pass it on to you.

The price CIF Antwerp is generally something \_\_\_\_\_ US\$ 25 per kg - types, quality, minimum order quantity, delivery etc. to be confirmed.

\_\_\_\_\_ we would appreciate some information on your company's background and \_\_\_\_\_. We would point out at this juncture that it is to be expected that the Chinese supplier will \_\_\_\_\_ payment by \_\_\_\_\_.

Should you have any queries please do not hesitate to contact us.

Yours faithfully  
Lancashire Enterprises plc  
Mannix Fu  
Project Executive / Trade Dept.

#### *Vocabulary*

at this juncture – **в настоящий момент**  
be something in the region of – **в районе. около**

descriptive literature – **информационные материалы**

payment by letter of credit – **оплата аккредитивом**

source – **касательно, по поводу**

stipulate – **ставить условием, обуславливать**

---

## 5. INFORMATION

*Fill in the gaps with the appropriate word combination from the box.*

a second branch	new premises
a 5% discount	on his own
bulky items	price tag
customer demand	rely on
free of charge	ample parking facilities
miss the chance	to convince
new range	

18 February 20..  
Prince DIY Centre  
OXFORD

Dear Customer

DIY ON YOUR DOORSTEP!

We are delighted to report that \_\_\_\_\_ for our unbeaten range of "do-it-yourself" equipment and materials has increased at such a staggering pace, that we are shortly to be opening \_\_\_\_\_ just outside town on the new Price-wise Trading Estate.

Our new branch, at 42-50 Grove Road, will provide \_\_\_\_\_ and will stock all the lines you have come to know and rely on together with a whole \_\_\_\_\_ of modestly priced accessories.

Just \_\_\_\_\_ you how serious we are, we're offering \_\_\_\_\_ on all cash sales **over £25 during the first month of business as from the first of** next month. We'll deliver all \_\_\_\_\_ (marked with a red star on

the \_\_\_\_\_) to your front door absolutely \_\_\_\_\_ within a 25-mile radius.

So don't \_\_\_\_\_ of cashing in on our once-in-a-lifetime throw-away offers! We're looking forward to greeting you on our \_\_\_\_\_ on June 1st and we're absolutely certain you'll be glad you came!

Yours Sincerely

### *Vocabulary*

at a staggering pace – в головокружительном темпе

a throw-away-offer – здесь: уникальное предложение

bulky – большой, крупный

DIY = do-it-yourself

modestly priced accessories – детали по умеренным ценам

parking facilities – возможности парковки

price tag - ценник

---

*1. In the letters 1-5 find the English equivalents to the following words and word combinations in Russian:*

1. экспортная цена
2. сектор рынка
3. эксклюзивный представитель
4. перевозка за счет покупателя
5. производственный план
6. возможности парковки
7. продажа за наличные
8. информационные материалы
9. вновь созданная фирма
10. упаковка
11. переход к рыночной экономике
12. возможность укрепить связи с...
13. первого сорта
14. образец
15. финансовое положение
16. дополнительные расходы

- 17. цена за штуку
- 18. общая цена
- 19. подтвержденный аккредитив
- 20. коносамент
- 21. в трех экземплярах

2. Choose the proper English words or word combinations for the Russian fragments given in brackets:

looking forward, quantity discounts, delivery, look forward, require, suit individual requirements, enclose, prices, supply, newly-established, discount, return the goods, indicate, do not hesitate to contact us, carriage forward, replacements, financial standing, equipment, opportunity, queries, cash sales, manufacturing process, new premises, sale or return basis, appreciate, activities, after-sale service, oversight on your part, conforms, share of the market

- 1. We **(с нетерпением ожидаем)** to receiving **(замену)** corresponding to your high standards.
- 2. We are a **(недавно основанная)** firm specializing in the **(поставка)** of transport **(оборудование)**.
- 3. We're **(с нетерпением ожидаем)** to **(приветствуем)** you on our **(новое помещение)**.
- 4. We would **(оценим)** some information on your company's background and **(финансовое положение)**.
- 5. We **(прилагаем)** for your information a brochure describing our **(деятельность)** in more detail.
- 6. Would you **(указывать)** details of your export **(цены)** and **(количественные скидки)** and state whether goods on a **(покупка с правом возврата)** can be supplied.
- 7. The **(производственный процесс)** used **(соответствует)** to international standards.
- 8. We feel sure that this is an **(недосмотр с вашей стороны)** but, we have no alternative but to **(возвратить товары)** to you, **(с неоплаченной перевозкой)**.



9. There will be ample (**возможность**) for your company to acquire a substantial (**долю рынка**) if your products and (**обслуживание после продажи**) are to good standard, and (**доставка**) is prompt.

10. Should you have any (**вопросы**) please (**свяжитесь с нами без колебаний**).

11. We're offering a 5% (**скидку**) on all (**продажи за наличные**) over £25 during the first month of business.

12. Should you so (**требуется**) the product can be modified to (**соответствовать индивидуальным требованиям**).

---

## 6. PLACING A SPECIFIC ORDER

*Fill in the gaps with the appropriate word combination from the box.*

above prices at fault be charged to firm	in your favour terms of payment validity of the credit
---	--

17 October 20..  
Lupton Bros Ltd  
England

Dear Sirs,

OUR PURCHASE ORDER NO.5769F/KED

We refer to your fax No. 0254 36279 dated 5 October 20.. relating to our enquiry No. 921/KED and wish to place an order for the following items:

QTY.	DESCRIPTION	U. PRICE	T. PRICE
5,000	Rubberized spindles	£0.80	£4,000.00
	Mail agency		£40.00
	Legalization and Certification		£150.00
	TOTAL PRICE FOB		£4,190.00

(SAY FOUR THOUSAND ONE HUNDRED AND NINETY POUNDS STERLING ONLY)

TERMS

PRICES

The \_\_\_\_\_ are \_\_\_\_\_ and subject to no future change and are quoted FOB, packing included.

N.B. Kindly let us have a new Pro-forma Invoice in 10 (ten) copies, showing FOB prices, fixed delivery period and \_\_\_\_\_.

PAYMENT

Against a confirmed L/C only.

Should any extension of the \_\_\_\_\_ be necessary as a result of your being \_\_\_\_\_, extra expenses incurred will \_\_\_\_\_ you.

N.B. This order is subject to the approval of the appropriate authorities and to the opening of the necessary credit \_\_\_\_\_.

DELIVERY

4 month from opening of L/C

INSURANCE  
& FREIGHT

As per our circulars enclosed.

CONDITIONS

Shipment by container is not allowed.

OF

Shipment to be effected through:

SHIPMENT

KHEDIVAL MAIL LINE (AGENCY) AIRWORK  
HOUSE 35 PICCADILLY L O N D O N

We look forward to receiving your confirmation and remain

Yours faithfully

*Vocabulary*

be subject to – **подчиняться, иметь силу, быть действительным**

be at fault - **быть виновным, по чьей-л вине**

confirmed L/C – **подтвержденный аккредитив**

fixed delivery period – **установочный срок поставки**

incur – нести расходы  
 packing included – включая упаковку  
 purchase order – заказ на покупку  
 place an order – размещать заказ  
 pro-forma invoice – образец фактуры, предварительная фактура  
 rubberized spindle – прорезиненное веретено  
 qty = quantity - количество  
 u.price = unit price – цена за штуку  
 t.price = total price – общая цена  
 validity – срок действия

---

## 7. CONFIRMATION OF ORDER

*Fill in the gaps with the appropriate word combination from the box.*

confirmed L/C	trust
good condition	the provisions
invoice	will be effected

1 November 20..  
 KAFR EL DAWAR A.R.E.  
 EGYPT

Dear Sirs

Thank you for your letter of 17 October.

We hereby confirm your Purchase Order No. 5769 F/KED for 5,000 **rubberized spindles for Northrop looms, total price £4,190.00, FOB U.K.** port, payment to be made by \_\_\_\_\_.

We note your Conditions of Shipment and confirm that the order \_\_\_\_\_ as per \_\_\_\_\_ of your Insurance and Freight Circulars.

As requested we enclose a new pro-forma \_\_\_\_\_ and ten copies thereof.

We \_\_\_\_\_ the goods will arrive punctually and in \_\_\_\_\_ and look forward to doing further business with you in the future.

Yours faithfully  
Export Manager

*Vocabulary*

as per - **согласно**

confirmed L/C – **подтвержденный аккредитив**

Insurance and Freight Circular – **страховой и фрахтовый циркуляр,**  
**отгрузочный формуляр**

---

## 8 PLACING A SHIPPING ORDER WITH A FREIGHT FORWARDER

*Fill in the gaps with the appropriate word combination from the box.*

as soon as	Insurance
containers	notify
In the course	

4 July 20..  
INTRASHIP LTD  
England

Dear Mrs Horrocks

\_\_\_\_\_ of this week you will be receiving, FOB Dover, 2 \_\_\_\_\_ of electric guitars and amplifiers marked S.W./93 1-2. They are to be shipped on the first available vessel to Rock Nouveau, 16 rue du General Leclerc, Bayonne, France. \_\_\_\_\_ will be covered by us.

Please make out the B/L to order in triplicate and send all three copies to ourselves. Please also \_\_\_\_\_ us of the name of the vessel \_\_\_\_\_ this is known to you.

Yours sincerely  
MUSIC AND MORE LTD  
Timothy Dearing  
Sales Director

## Vocabulary

B/L = bill of lading - коносамент

make out - выписывать

notify – сообщать, уведомлять

triplicate – в трех экземплярах

---

1. Match a word or word combination from letters 6-8 in column A with its meaning in column B.

A	B
1. purchase order	a) сроки оплаты
2. confirmation	b) в хорошем состоянии
3. pro-forma invoice	c) страховка
4. packing included	d) доверять
5. terms of payment	e) образец фактуры
6. trust	f) уведомлять
7. in good condition	g) заказ на покупку
8. notify	h) подтверждение
9. insurance	i) обычная почта
10. surface mail	j) обслуживание после продажи
11. range	k) эксклюзивный представитель
12. business associate	l) предприятие
13. to suit requirements	m) настоящий заказ
14. after-sale service	n) в соответствии
15. manufacturing process	o) ассортимент
16. enterprise	p) с вашей стороны
17. sole agent	q) производственный процесс
18. order in hand	r) отвечать требованиям
19. to be in agreement with	s) деловой партнер
20. on your part	t) включая парковку

2. Choose the proper English words or word combinations for the Russian fragments given in brackets:

packing included, prices are firm, make out the B/L, order, delivery period, vessel, notify us, look forward, in triplicate, validity, covered, pro-
--

visions, in your favour, future change, extension, order, confirm, yours faithfully, conditions of shipment, extra expenses, Insurance and Freight Circulars, confirmation, terms of payment, not allowed, insurance, approval, pro-forma invoice

1. We (ожидаем с нетерпением) to receiving your (подтверждение) and remain (с уважением).

2. The (цены твердые, окончательные) and subject to no (изменению не подлежат) and are quoted FOB, (включая упаковку).

3. (Страховка) will be (обеспечена денежным покрытием) by us.

4. Let us have a new (предварительная фактура, счет) showing FOB prices, fixed (срок поставки) and (условия платежа).

5. Please (составьте коносамент) to order (в трех экземплярах) and send all three copies to ourselves.

6. Should any (продление) of the (срок действия) of the credit be necessary as a result of your being at fault, (дополнительные расходы) will be charged to you.

7. This (заказ) is subject to the (одобрение) of the appropriate authorities and to the opening of the necessary credit of (на ваше имя).

8. We note your (условия поставки) and (подтверждаем) that the (заказ) will be effected as per the (условия) of your (страховой и фрахтовой формуляр).

9. Shipment by container is (не разрешена).

10. Please (известите нас) of the name of the (судно) as soon as this is known to you.

*Read and translate the letters given below and do the task afterwards.*

Champion Co.

10 March, 2010

Amour and Sons  
Newcastle Road  
Nottingham, 1256-A  
England

Dear Sirs

Many thanks for your order of 3 March. We are glad to inform you that the goods are nearly ready for dispatch. As requested, we have included a packing note with your goods and have pleasure in enclosing a further copy of the note.

Your instructions as to marking have been also accurately carried out. Our whole experience is at your service. We hope you will make use of it. We look forward to hearing from you shortly.

Sincerely yours  
James Bond Junior

*Letter to a forwarding agency concerning transshipment*

We are going to have to ship the goods listed below, which are currently in transit. The shipping documents for this transaction are to be prepared at your end, and we would be grateful if you would kindly let us know what you can do to get them ready for shipment, and what you need from us. **Please note that our agents in Athens are ... & Co.;** and that the bank handling the documents is the office of the National Bank . We look forward to hearing from you very soon on this subject, and thank you in advance for your co-operation.

*You are currently **working in...., which is a big industrial corporation.**  
**In order to increase production quantities you need new...***

- a) Write a letter to a forwarding agency concerning transshipment.*
- b) Write an answer concerning marking and parking of the goods ordered.*

---

## 9. INSURANCE AND SHIPPING INSTRUCTIONS, CUSTOMS CLEARANCE

*Fill in the gaps with the appropriate word combination from the box.*

a considerable amount of time	draw your attention
airmail	exceeds
AIRMAIL letter	great assistance to

amounts to	in connection with
at destination	in good time
at least 24 hours	point out
carrying ship	in tracing
cases	invoice
clearance	ordinary orders
consignment	sailing date
complications	to draw your attention to
customs authorities	the hold
dispatching	the value
delay	total number

Societe Misr de Filature  
EGYPT

## INSURANCE AND FREIGHT CIRCULAR

Dear Sirs

Further to our attached order we wish \_\_\_\_\_ our Insurance & Shipping Instructions and would \_\_\_\_\_ that they are also those observed by ourselves.

### 1. SHIPPING METHOD

(a) Goods must be transported in \_\_\_\_\_ of the ship.

(b) Shipping to be effected using ships not more than 20 years old and also according to the Institute of London Underwriters classification clause.

### 2. SHIPPING INSTRUCTIONS

All \_\_\_\_\_ should be marked S.M. followed by the number of the case, followed by the total number of cases in the \_\_\_\_\_.

Example: If the cases are part of order 8706 and the \_\_\_\_\_ of cases in the consignment \_\_\_\_\_ 4, the cases should be marked:

S.M./8706/1/4 S.M./8706/2/4 S.M./8706/3/4 S.M./8706/4/4

When \_\_\_\_\_ the order please \_\_\_\_\_ us the NAME of the SHIP on which the goods are to be shipped and the number of the purchase order relating to the consignment. This information will be of \_\_\_\_\_



us \_\_\_\_\_ the goods upon their arrival at port and in proceeding with their \_\_\_\_\_ through customs immediately, thus avoiding \_\_\_\_\_.

### 3. DETAILS TO BE COMMUNICATED TO US

Please arrange for us to receive, \_\_\_\_\_ before \_\_\_\_\_, details of the consignment together with the following information to enable us to effect the required insurance:

- (a) Name of the \_\_\_\_\_
- (b) Value of the goods despatched
- (c) Port of loading

Before shipping any consignment, \_\_\_\_\_ of which amounts to or \_\_\_\_\_ **££30,000 (thirty thousand Egyptian pounds) at any one time**, the above information must be communicated to us TELEGRAPHICALLY

For \_\_\_\_\_ the information, as specified above, can be sent by \_\_\_\_\_.

N.B. Failure to communicate details to us telegraphically, as specified above, will oblige us to hold you responsible for any decision prejudicial to ourselves \_\_\_\_\_ our open insurance policy.

### 4. FREIGHT

"From port of despatch to Alexandria port", to be payable \_\_\_\_\_, in "EGYPTIAN CURRENCY".

### 5. CLEARANCE

To enable us to clear the goods through customs please airmail us the appropriate \_\_\_\_\_, packing and specification lists in 10 (ten) copies or more if possible.

In this respect we would \_\_\_\_\_ to the fact that by sending your invoices and packing lists etc. as requested you will save us \_\_\_\_\_ and will, above all, avoid \_\_\_\_\_ with our \_\_\_\_\_.

Please follow the above instructions for all consignments sent against our orders. We depend on your co-operation for us to receive the information required \_\_\_\_\_.

Yours faithfully

### *Vocabulary*

amount to - **составлять сумму**

attached - **в приложении**

classification clause - пункт/разряд классификации  
 clearance through customs – растаможивание  
 consignment – партия товаров, груз, консигнация  
 despatch- отсылать, отправлять  
 effect shipping – производить отгрузку  
 hold - трюм  
 in good time - вовремя  
 invoice – счет-фактура  
 open insurance policy – общий страховой полис  
 prejudicial – наносящий ущерб  
 proceed with –здесь: проводить, улаживать  
 port of dispatch – порт назначения  
 shipped method – способ отгрузки  
 trace - зд: находить  
 underwriter - страховщик

## 10. ADVICE OF DESPATCH

*Fill in the gaps with the appropriate word combination from the box.*

commercial invoice	in triplicate
complete set	is due to leave
consignment	on board m.v.
current price list	the above mentioned purchase or-
evidencing	der
have handed	to your complete satisfaction
in accordance with	

Lupton Bros Ltd  
 England  
 15 January 20..

Dear Sirs

Your Purchase Order No. 5769F/KED

We are pleased to inform you that the goods ordered as per \_\_\_\_\_ have been despatched \_\_\_\_\_ your instructions.

They have been packed in 5 cases, 100 to a case. The cases are marked S.M./5769F/KED and numbered 7-5/5.

The \_\_\_\_\_ is being shipped \_\_\_\_\_ "EgyptianStar", which \_\_\_\_\_ Southampton at the end of this month, arriving in Alexandria on 15 March.

We \_\_\_\_\_ our sight draft for £4,190.00 to the Arabian Bank, London together with the documents required under the terms of the L/C, namely: a \_\_\_\_\_ of clean, shipped on board Bs/L endorsed to your order, marked in accordance with your specifications; one original and ten copies of the \_\_\_\_\_; a certificate of U.K. origin duly legalized by the Arab Republic of Egypt Representation; a declaration from the Egyptian Company for Maritime Transport "Martrans", \_\_\_\_\_ that the goods have been shipped by them; a packing list; insurance certificate \_\_\_\_\_.

The Arabian Bank has paid the sum.

We trust that the goods will be \_\_\_\_\_ and look forward to hearing from you again. We also enclose for your information some changes to our \_\_\_\_\_.

Yours faithfully  
LUPTON BROS LTD  
Export Manager

### *Vocabulary*

certificate of origin – сертификат о происхождении

clean B/L – чистый коносамент

duly legalized – надлежащим образом легализованный

evidence – являться доказательством, доказывать

endorse – индоссировать (делать передаточную надпись)

insurance certificate – страховой сертификат

in triplicate – в трех экземплярах

m.v.= motor vessel – т.х - теплоход

purchase order – заказ на покупку

sight draft- тратта (переводный вексель) на предъявителя

100 to a case – по 100 штук в ящике

## 11. REQUEST FOR PRO-FORMA INVOICE

*Fill in the gaps with the appropriate word combination from the box.*

above-mentioned	pro-forma invoice
authorities	requirements
discounts	rebate
justify	to apply for

10 April 20..  
Diamantsagen Wilde GmbH  
GERMANY

Dear Mr Wilde

Our Enquiry PL/384 of 2nd March 2010  
Your Offer No. 58397 of 21st March 2010

We are pleased to inform you that your DX 33 saw- blades wholly conform to our quality \_\_\_\_\_. We should therefore like to place an order for 25 units, provided you can see your way clear to granting us a further \_\_\_\_\_ of 5% on your prices as quoted in the \_\_\_\_\_ offer. We feel that the volume of the order we are interested in placing would \_\_\_\_\_ this small concession.

However, to enable us to import these saw-blades into India we will need \_\_\_\_\_ an import license from our local Government \_\_\_\_\_ and would therefore ask you to send us a \_\_\_\_\_ to include the following details:

- exact description of the goods
- unit and total price with \_\_\_\_\_
- terms of payments and delivery CIF Calcutta
- packing list

We would be grateful if you would send the pro- forma invoice by registered mail. As soon as we have received the import license, we shall telex our order to you and open the L/C with our bankers.

Yours sincerely

*Vocabulary*

by registered mail - **заказное**

rebate - **скидка**

saw-blade – **дисковая пила**

---

## 12. SENDING THE INVOICE

*Fill in the gaps with the appropriate word combination from the box.*

articles	discount
are due to	on board
at any time	perfect condition
at your service	transport costs
bank transfer	your premises
cheque	

7 January 20..

Mr Arthur M Jones

Laser Engineering Ltd 1

United Kingdom

Dear Mr Jones,

Your Order 835/XI of 15 Dec 20...

We are pleased to inform you that the \_\_\_\_\_, as per the above-mentioned order, were despatched by lorry yesterday. They will be shipped across the Channel \_\_\_\_\_ SS Marina tomorrow and \_\_\_\_\_ arrive at \_\_\_\_\_ at the beginning of next week.

Please find enclosed our invoice No. 351685 T for € 17,850.00 including all \_\_\_\_\_. We would ask you to settle it either by \_\_\_\_\_ or by \_\_\_\_\_ within 30 days, subject to the usual early payment \_\_\_\_\_ of 3 per cent.

We trust that you will receive the goods in \_\_\_\_\_ and remain \_\_\_\_\_ for further deliveries \_\_\_\_\_.

Yours sincerely

Daffur & Sattel GmbH  
Export Dept.

### *Vocabulary*

by bank transfer – **банковским переводом**

premises – **офисные помещения**

settle - *здесь*: **уплачивать, оплачивать**

the usual early payment discount – **обычный дисконт (учет векселей), необходимый для скорейшей оплаты**

---

*1. In letters 9-12 given above find English equivalents to the following Russian words and word combinations:*

1. растаможивание
2. страховщик
3. на борту судна
4. счет-фактура
5. таможенные органы
6. по 100 штук в ящике
7. упаковочный лист
8. место назначения
9. таможенные органы
10. заказное письмо
11. офисные помещения
12. общее количество чего-либо
13. привлечь чье-либо внимание
14. обычный заказ
15. к вашему полному удовлетворению

*2. Choose the proper English words or word combinations for the Russian fragments given in brackets:*

sailing date, consignment, customs authorities, further deliveries, declaration, unit and total price, pro-forma invoice, grant us a rebate, usual early payment discount, draw your attention, commercial invoice, attached order, in triplicate, required, discounts, concession, sight draft, at
---

your service, include, exact, in perfect condition, insurance, bank transfer, save time, duly legalized, quoted in the offer, arrange, L/C, arrange, invoices, volume of the order, packing list, conform, avoid complications, clean Bs/L, Insurance & Shipping Instructions, place an order, terms, terms of payments and delivery, in accordance with, within, inform

1. We ask you to send us a (образец счета-фактуры) and (включить) the following details: (точное) description of the goods; (общая и поштучная цена) with (скидки); (условия платежа и ставки) CIF Calcutta; packing list.

2. The (объем заказа) we are interested in placing would justify this small (уступка).

3. Please (организуите) for us to receive, at least 24 hours before (дата отплытия), details of the (партии товаров, грузов).

4. We would ask you to settle our invoice either by (банковский перевод) or by cheque (в течение) 30 days, subject to the (обычный дисконт, необходимый для скорейшей оплаты) of 3 per cent.

5. We are pleased to (сообщить) you that your instruments wholly (соответствуют) to our quality requirements.

6. In this respect we would (привлекаем ваше внимание) to the fact that by sending your (счет-фактура) and packing lists you will (сохраните время) and will (избегать осложнений) with (таможенными властями).

7. We have handed our (тратта) for £4,190.00 to the Bank, London together with the documents (необходимых, требуемых) under the (условия) of the (аккредитив), namely: a complete set of (чистые коносаменты) endorsed to your order, marked (в соответствие с) your specifications; one original and ten copies of the (коммерческий счет-фактура); a certificate of U.K. origin (надлежащим образом легализованный); a (декларация), a (упаковочный лист); (страховой) certificate (в трех экземплярах).

8. We should like to (разместить заказ) for 25 units, provided you can (предоставить скидку) of 5% on your prices as (как котируется в предложении).

9. Further to our (прилагаемый заказ) we wish to draw your attention to our (инструкции по страхованию и погрузке).

10. We trust that you **will receive the goods (в отличном состоянии)** and remain **(к вашим услугам)** for **(для дальнейших поставок)** at any time.

---

### 13. ENQUIRY ABOUT FREIGHT RATES

*Fill in the gaps with the appropriate word combination from the box.*

freight rates	net weight
further charges	quote
	shipment

10 November 20..  
Specialised Shipping Services

Dear Sirs

Please quote us your most favorable \_\_\_\_\_ for the transport of 50 tones of palletized house bricks, \_\_\_\_\_ 1 tone per unit, for \_\_\_\_\_ from Southampton to Tunis in the first two weeks of December.

Please \_\_\_\_\_ us assuming delivery F.O.B. Southampton stating details of shipping commission and any \_\_\_\_\_.

Yours faithfully  
Production Manager

#### *Vocabulary*

freight rate – ставка фрахта

further charges – дальнейшие расходы

quote – назначать, предлагать

palletize - упаковывать в готовые поддоны

---



## 14. FREIGHT OFFER

*Fill in the gaps with the appropriate word combination from the box.*

additional charge	per metric tone
demurrage	sailing card
enquiry	to issue
is due to	with 4 lay days

15 November 20..  
Whaleys Bricks Ltd

Dear Mr. Whaley

Your Freight Enquiry of 10 November 20..

Thank you for your \_\_\_\_\_ regarding the transport of 50 tonnes of palletised house bricks. Our offer is as follows:

**M.V. CLEETHORPES at £50 \_\_\_\_\_ or 10 cubic metres, at steamer's option, \_\_\_\_\_.**

As can be seen from the enclosed \_\_\_\_\_, the vessel is currently located in Marseille and \_\_\_\_\_ dock in Southampton on November 30th. Loading will commence as from December 1st with an \_\_\_\_\_ of **£250 for every day of \_\_\_\_\_.**

If you accept this offer please forward us the charter party in quadruplicate to enable us \_\_\_\_\_ the necessary instructions to the ship's captain, Mr. Terry Wrigglesworth.

We look forward to your early reply.

Yours sincerely  
Theresa Templeton  
Specialised Shipping Services

### *Vocabulary*

freight enquiry – **запрос о фрахте**

at steamer's option – **по выбору парохода (пароходной компании)**

lay day – **сталийный день**

sailing card – **расписание судов**

dock – отправляться в док  
commence- начинать  
demurrage – демередж (плата за простой судна)  
forward – рассылать, посылать  
charter party - чартер  
in quadruplicate – в четырех экземплярах

---

## 15. ACCEPTANCE OF FREIGHT ORDER

*Fill in the gaps with the appropriate word combination from the box.*

as agreed	in the course of
dated	the charter party
freight offer	will be delivered
	no reason

21 November 20..  
Specialised Shipping Services  
Coppull Trading Estate

Dear Ms Templeton

Thank you for your \_\_\_\_\_ for palletised house bricks \_\_\_\_\_ 15 November, which we are pleased to accept as follows:

**M.V. CLEETHORPES at £50 per metric tonne or 10 cubic metres, at steamer's option, with 4 lay days**

The consignment of house bricks is from Redland Cement Ltd, and \_\_\_\_\_ F.O.B Southampton by Gotruck Haulage Ltd on December 1st.

You will be receiving \_\_\_\_\_ in quadruplicate by separate post \_\_\_\_\_ this week.

We hope that there will be \_\_\_\_\_ for delay of any sort and look forward to our order being shipped \_\_\_\_\_.

Yours sincerely  
WHALEYS BRICKS LTD  
Managing Director

*Vocabulary*

consignment – партия товаров, груз  
by separate post – отдельной почтой

---

16. FREIGHT FORWARDER CONFIRMS ORDER

*Fill in the gaps with the appropriate word combination from the box.*

be forwarded in accordance with in procedure mentioned below	notify relating to to confirm
---	-------------------------------------

Intertrans Ltd.  
Marine Walk  
12 January 20..

Dear Sirs

We are pleased \_\_\_\_\_ that your shipping and on-carriage instructions regarding the consignment \_\_\_\_\_ will be complied with as requested.

The documentation \_\_\_\_\_ the consignment will \_\_\_\_\_ to you \_\_\_\_\_ your wishes as stated in our previous correspondence.

Consignor: Cornwall Plastics Ltd  
Cornwall

Consignee: Slumberland Foam Inc.  
Pittsburgh, Pennsylvania, USA

Consignment: 2,400 kg (20 drums) polyester of silicic acid

Marks: CP/PSA92/1-20

Total weight: 4,543.00 kg

Shipped on: 10 January 20..

Vessel: M.S. Morning Star

Destination: Pittsburgh, Pennsylvania, USA

Should any delay arise or any change \_\_\_\_\_ prove necessary, we will \_\_\_\_\_ you as appropriate.

Assuring you of our best attention at all times

Yours faithfully  
INTERTRANS LTD  
Philip Jones Manager  
cc: Thomas Branscope  
Industrial Shipments Dept.

### *Vocabulary*

on-carriage instructions – **инструкция по дальнейшей перевозке**

comply with – **соответствовать**

consignor - **отправитель**

consignee – **грузополучатель**

M.S. = motor ship - **теплоход**

cc = carbon copy – **копия под копирку**

---

*1. Match the following expressions from letters 9-12 in English with the appropriate equivalents in Russian.*

- | A                                  | B                              |
|------------------------------------|--------------------------------|
| 1. freight rate                    | a) отдельной почтой            |
| 2. unit                            | b) в течении этой недели       |
| 3. additional charge               | c) в любое время               |
| 4. by separate post                | d) как согласовано             |
| 5. net weight                      | e) предмет, штука              |
| 6. loading                         | f) партия товаров              |
| 7. in the course of this week      | g) дополнительные расходы      |
| 8. sailing card                    | h) избегать сложностей         |
| 9. demurrage                       | i) ставка фрахта               |
| 10. as agreed                      | j) вес нетто                   |
| 11. no reason for delay            | k) расписание судов            |
| 12. consignment                    | l) нет причин для задержки     |
| <b>13. to draw one's attention</b> | m) стоимость                   |
| 14. case                           | n) в распоряжении              |
| 15. value                          | o) ящик                        |
| 16. to avoid complications         | p) соответствовать требованиям |
| 17. at one's disposal              | q) скидка                      |

18. discount  
19. to conform to requirements  
20. at any time

- г) плата за просто судна  
s) погрузка  
t) обратить внимание

2. Choose the proper English words or word combinations for the Russian fragments given in brackets:

mentioned below, shipping commission, further charges, delay, as appropriate, proves necessary, demurrage, confirm, palletised bricks, on-carriage instructions, forwarded to you, as requested, relating to the consignment, charter party, loading, delay arise, by separate post, palletized, as stated, additional charge, enquiry regarding, look forward, as agreed, notify, quote, previous, freight rates, per unit, shipment

1. Please quote us details of (комиссию за погрузку) and any (дальнейшие расходы).
  2. The documentation (в отношении партии товара) will be (направлены вам) in accordance with your wishes (как указано) in our (предыдущая) correspondence.
  3. (Погрузка) will commence as from December 1-st with an (дополнительные расходы) of £250 for every day of (простой судна).
  4. We hope that there will be no reason for (задержка) of any sort and (ожидаем с нетерпением) to our order being shipped (как согласовано).
  5. Please (назначьте, предложите) us your most favourable (ставки фрахта) for the transport of (упакованный в поддоны кирпич), net weight 1 tonne (на единицу), for (для отправки) from ... to ....
  6. You will be receiving the (договор о фрахтовании) in quadruplicate (отдельной почтой) in the course of this week.
  7. We are pleased to (подтвердить) that your shipping and (инструкции по дальнейшей перевозке) regarding the consignment (указанные ниже) will be complied with (согласно вашей просьбе).
  8. Thank you for your (запрос, касающийся) the transport of 50 tonnes of (упакованный в поддоны) house bricks.
  9. Should any (возникнет задержка) or any change in procedure (окажется необходимым), we will (сообщим) you (как полагается).
-

## 17. FREIGHT FORWARDER REQUESTS DOCUMENTS FOR CUSTOM CLEARANCE

*Fill in the gaps with the appropriate word combination from the box.*

forwarding arrangements  
further details  
haulers

hesitate  
in accordance with  
notificaton

EUROFREIGHT LTD  
e-mail: [euofreight@aol.com.uk](mailto:euofreight@aol.com.uk)  
24 March 20..  
LONDON

Dear Sirs

Export Consignment to Budapest. Hungary

We refer to the following shipping order:

Consignee: Budapest Magyarorszag (Hungary)  
Consignment: 10,565 kg bitumen (15 drums) (value £13,300)  
Order No.: 191/1.93 (as per your fax of 12 March ..)  
Delivery: 3-4 weeks after receipt of L/C  
Hauliers: Ungarocamion, Budapest

Your customer, *Budapesti Vegyi Muvek*, has requested us to collect the above consignment using Ungarocamion \_\_\_\_\_ and forward it \_\_\_\_\_ his instructions to Hungary.

Please therefore let us have details of either the L/C or the documentary collection (B/E, Bs/L) agreed, to enable us to progress \_\_\_\_\_ and issue a forwarder's receipt.

For customs clearance we require:

For Export

- Export \_\_\_\_\_ or export declaration

For Import into Hungary

- Commercial Invoice in triplicate
- Packing specification in triplicate

Should you require any \_\_\_\_\_ or information please do not \_\_\_\_\_ to call us on 0181 580 4971 or fax us on 0181 580 4862, or send us an e-mail.

Yours faithfully  
EUROFREIGHT LTD  
Arnold Graham  
Transport Controller

### *Vocabulary*

shipping order - **отгружаемый заказ**  
hauler – **экспедитор грузового транспорта**  
documentary collection – **торговое инкассо**  
B/E = bill of exchange – **тратта, переводной вексель**  
Bs/L = bills of lading - **коносаменты**  
forwarding arrangement – **фрахтовые мероприятия**  
**forwarder's receipt** – **расписка экспедитора**  
export notification – **экспортное уведомление**

---

## 18. REFFERAL OF CUSTOMER COMPLAINT TO INSURANCE COMPANY

*Fill in the gaps with the appropriate word combination from the box.*

acted correctly	insurance agent
case	insurance cover
delivered by	looked into the matter
inconvenience	minor accident
indemnification	damage
	to your satisfaction

Your ref.: UNG/009.92.1  
5 May 20..  
Budapest  
HUNGARY

Dear Mr Zold

Thank you for your letter of 28 April in which you give details of \_\_\_\_\_ to 3 drums of bitumen \_\_\_\_\_ ourselves to your company on April 19th. We regret the \_\_\_\_\_ caused and feel you \_\_\_\_\_ by having the damage assessed by your \_\_\_\_\_.

We have \_\_\_\_\_ and examined the driver's log for the trip in question and have discovered that our vehicle was involved in a \_\_\_\_\_. The \_\_\_\_\_ is currently in the hands of our lawyers and should be settled by the end of the month. Our \_\_\_\_\_ provides for \_\_\_\_\_ for any eventuality so we would therefore request you to approach our insurers, whose name and address are as follows:

Accident Insurance Europe  
Insurance House  
London EC1A 4WW  
England.

Please quote policy No. GLX/342-00/93.

We trust the matter will be settled \_\_\_\_\_ in due course.

Yours sincerely  
EUROFREIGHT LTD

### *Vocabulary*

have the damage assessed – констатировать ущерб

log – судовой журнал, журнал водителя

insurance cover – покрытие страховки

indemnification – возмещение ущерба

approach – здесь: обращаться к кому-либо

---

## 19. REQUEST FOR A CUSTOMS INVOICE TO BE ISSUED

*Fill in the gaps with the appropriate word combination from the box.*

at your earliest convenience	import duty
complete	ordered
grateful	require



April 20..  
New Form Plastics Moulds Ltd  
OXFORD  
England

Dear Sirs

As the value of the plastics moulds \_\_\_\_\_ by ourselves in our letter of **February 28 exceeds £50,000 sterling, we \_\_\_\_\_ a customs invoice** for the customs authorities here to enable them to assess \_\_\_\_\_. We would therefore be most \_\_\_\_\_ if you would issue this document \_\_\_\_\_ to enable us to \_\_\_\_\_ the necessary formalities at this end.

Yours faithfully  
MUTUMBUKO PLASTICS LTD  
Import Manager

*Vocabulary*

at your earliest convenience – **при первой возможности**

---

## 20. CALLING IN AN ASSESSOR

*Fill in the gaps with the appropriate word combination from the box.*

assess	premises
an accident	submit
approach road	the damage
claim	the remaining part
insurers	working hours
investigation	

E-mail: [NRWfracht@vorm.de](mailto:NRWfracht@vorm.de)  
15 April 20..  
Balcombes Insurance Loss Assessor,  
Surveyors and Valuers  
LONDON  
England

Dear Sirs

Vehicle Damage and Part-Loss of Load

Please \_\_\_\_\_ the costs arising from \_\_\_\_\_ to our vehicle Reg. No. DO-KA 385 and its load (motor vehicle components) when it was involved in \_\_\_\_\_ with an oncoming lorry on the \_\_\_\_\_ to Dover Eastern Docks on April 12th.

The vehicle and \_\_\_\_\_ of the load were recovered by:

*Crowvale Haulage Ltd*  
*(Commerical Vehicle Recovery Services)*  
*Silverdale House*  
*Pump Lane*  
*London*

at whose \_\_\_\_\_ they can be examined during usual \_\_\_\_\_ by appointment.

The Dover Constabulary has made a report on the accident and an \_\_\_\_\_ into the collision is being conducted by Detective Constable.

We also enclose on a separate sheet from our \_\_\_\_\_, Star Insurance, a list of points which should be considered in your report.

Please \_\_\_\_\_ your report and invoice in triplicate to ourselves as soon as possible to enable us to make a \_\_\_\_\_ to our insurers.

Yours faithfully  
NRW Frachtenkontor  
Transport Manager

Enc

*Vocabulary*

Surveyor - **эксперт**

Valuer - **оценщик**

oncoming - **встречный**

approach road – **подъезд, подъездной путь**

---

1. Find the English equivalents to the following word combinations from letters 17-20.

1. экспедитор грузового транспорта
2. очистка на таможне
3. коносамент
4. отгружаемый заказ
5. неудобство
6. покрытие страховки
7. рассмотреть дело
8. адвокат
9. импортная пошлина
10. при первой возможности
11. объявление, реклама
12. опыт работы
13. расходы
14. участие
15. наниматель
16. помещение (месторасположение)
17. предоставлять
18. подъездная дорога
19. в течение следующих двух лет
20. отвечать за движение транспорта

2. Choose the appropriate English words or word combinations for the Russian variants given in brackets:

in accordance with instructions, make a claim, in triplicate, grateful, forwarding arrangements, remaining part of the load, issue, at your earliest convenience, for the customs authorities, forwarder's receipt, insurance cover, hauliers, submit, invoice, insurers, was involved in a minor accident, documentary collection, notification, in due course, request, assess, necessary, collect the consignment, damage, load, settled, by appointment, driver's log, we require, indemnification, trust, regret, accident, forward, customs clearance, premises, insurers, assess the costs, approach road, having the damage assessed, insurance agent, vehicle recovery services, duty, oncoming lorry

1. We would be most (благодарны) if you would (издадите, выпустите) this document (при первой возможности) to enable us to complete the (необходимые) formalities.

2. Our (страховое покрытие) provides for (возмещение ущерба) so we would (просим) you to approach our (страховщики).

3. Your customer has requested us to (забрать партию груза) using Belarusian (экспедиторы) and (направить) it (в соответствие с инструкциями) to Belarus.

5. Please (представьте) your report and invoice in triplicate to ourselves to enable us to (заявить претензию) to our (страхователям).

6. We have examined the (журнал водителя) for the trip in question and have discovered that our vehicle (попал в небольшую аварию).

7. For (растаможивание) we require: export (уведомление) or export declaration; commercial (счет-фактура) and packing specification (в трех экземплярах).

8. We (верим) the matter will be (решена) to your satisfaction (должным образом, в установленном порядке).

9. Please (оцените затраты) arising from the (повреждение) to our vehicle and its (груз) (motor vehicle components) when it was involved in an (авария) with an (встречный грузовик) on the (подъездная дорога).

10. Please let us have details of either the L/C or the (торговое инкассо) (B/E, Bs/L) agreed, to enable us to progress (фрахтовые мероприятия) and issue a (расписка экспедитора).

11. We (сожалеем) the inconvenience caused and feel you acted correctly by (констатировав ущерб) by your (страховой агент).

12. The vehicle and the (оставшаяся часть груза) were recovered by (аварийная транспортная служба) at whose (помещении) they can be examined during usual working hours (по договоренности).

13. (Нам требуется) a customs invoice (для таможенных органов) here to enable them to (оценить) import (пошлина).

---

## 21. JOB APPLICATION

*Fill in the gaps with the appropriate word combination from the box.*

advertisement	responsible for
bilingual	salary
current post	training course
earliest convenience	welcome an opportunity
enclose	work experience
for the post of	

15th June 20..  
Air Space Freight Forwarding  
NEWCASTLE  
England

Dear Sir or Madam

I am writing in reply to your \_\_\_\_\_ in the European News of June 12th \_\_\_\_\_ Sales Manager in your European Division.

I am aged 27, of German nationality, single, \_\_\_\_\_ German/English and I am currently employed as Freight Coordinator with Federal Express (Deutschland) in Dusseldorf where I am \_\_\_\_\_ freight movements to and from the US and the UK. I have held this post for three years now and would \_\_\_\_\_ to work in Britain.

I now have a total of 5 years' \_\_\_\_\_ in freight forwarding, having completed a 2 1/2-year \_\_\_\_\_ as a freight forwarder with Kuhne & Nagel, Dortmund, where I stayed for a further two years after completing my training period before taking up my \_\_\_\_\_ at Federal Express, My current performance-related \_\_\_\_\_ **is in excess of £ 30K p.a.**

I \_\_\_\_\_ a full curriculum vitae and the names of two referees as stipulated.

I look forward to your reply at your \_\_\_\_\_.

Yours faithfully

### Vocabulary

performance-related – в зависимости от достижений

£ 30K p.a. – 30000 фунтов стерлингов в год

curriculum vitae = cv – (авто)биография

referee – *здесь*: лицо, дающее рекомендацию

stipulate – требовать(ся), полагаться; обуславливать

---

## 22. INVITATION TO AN INTERVIEW

*Fill in the gaps with the appropriate word combination from the box.*

are being held	expenses
a second round	interview
arrival	participation
be notified	panel
confirm	submit

21 June 20..

Mr Peter Schulz

Alte Bahnhofstr. 100

44892 Bochum

Germany

Dear Mr. Schulz

Thank you for your letter of 15 June in which you \_\_\_\_\_ your application for the post of European Division Sales Manager.

Interviews for the post in question \_\_\_\_\_ in London at the Novotel at Heathrow Airport during the weekend of July 19-20. We are inviting suitable candidates to attend for a preliminary \_\_\_\_\_ on the Saturday. On the Sunday short-listed candidates will then proceed to \_\_\_\_\_ of interviews conducted by a \_\_\_\_\_ made up of our Human Resources Manager and staff.

All short-listed candidates will \_\_\_\_\_ approximately 10 days after interview.

Travel and accommodation \_\_\_\_\_ will be borne by the company for all candidates living outside the UK who are invited to interview.

Please \_\_\_\_\_ your \_\_\_\_\_ by return, indicating your time of \_\_\_\_\_.

Yours sincerely  
Air Space Freight Forwarding  
Human Resources Department

### *Vocabulary*

European Division – **Европейский отдел**

short-listed – **прошедшие первичный отбор**

panel – **отбор, конкурс; комиссия**

Human Resources Department – **отдел кадров**

---

## 23. TESTIMONIAL

*Fill in the gaps with the appropriate word combination from the box.*

chair meetings	liaising
deprive	resulting in
employer	responsibility
evaluating	resources
hesitate	skills
improvement	the course of
	user manual

3rd April 20..

To whom it may concern

Ms. Schnell

Ms. Schnell worked with Technology Transfer Systems Ltd. as Departmental Head in our software development and documentation department during the period from 1 January 20.. to 31 March 20..

After having rapidly taken stock of the \_\_\_\_\_ available in this department, both in terms of manpower and technology, she was able to proceed to \_\_\_\_\_ its strengths and weaknesses. Her restructuring of the section led to an immediate \_\_\_\_\_ in morale and performance \_\_\_\_\_ greater efficiency and dedication from all concerned.

The areas for which she took \_\_\_\_\_ involved many \_\_\_\_\_: documenting, typing and layout of a \_\_\_\_\_, testing the software system during development and \_\_\_\_\_ with software engineers as bugs or queries were raised.

Her ability to \_\_\_\_\_ and conduct them in a manner conducive to constructive results has proved invaluable in \_\_\_\_\_ her three years with our company.

Technology Transfer Technology Systems Ltd will sadly miss the skills and dedication of which Ms Schnell's departure will \_\_\_\_\_ the company. We do not \_\_\_\_\_ to recommend her to any future \_\_\_\_\_.

Yours faithfully

### *Vocabulary*

bug – **здесь: дефект, недочет**

chair – **вести собрание**

conducive to - **приводящий к чему-либо**

liaise - **поддерживать связь**

testimonial – **характеристика, рекомендательное письмо**

To whom it may concern – **тем, кого это может касаться**

take stock – **ознакомиться**

---

1. Match a word or word combination in column A with its meaning in column B.

- A
1. freight forwarder
  2. curriculum vitae
  3. freight movement
  4. preliminary

- B
- a) рабочая сила
  - b) колебаться, не решаться
  - c) заработная плата
  - d) двуязычный



- |                             |                          |
|-----------------------------|--------------------------|
| 5. manpower                 | e) время работы          |
| 6. departmental head        | f) участие               |
| 7. staff                    | g) частичная потеря      |
| 8. vehicle damage           | h) фрахтовая отправка    |
| 9. valuer                   | i) автобиография         |
| 10. working hours           | j) начальник отдела      |
| 11. part-loss               | k) предварительный       |
| 12. participation           | l) оценщик               |
| 13. to be responsible for   | m) персонал              |
| 14. salary                  | n) проблема, вопрос      |
| 15. to look into the matter | o) страховое покрытие    |
| 16. case                    | p) быть ответственным за |
| 17. bilingual               | q) оценивать             |
| 18. insurance cover         | r) рассмотреть вопрос    |
| 19. to hesitate             | s) транспортный ущерб    |
| 20. to assess               | t) экспедитор            |

2. Choose the appropriate English words or word combinations found in Letters 21-23 for the Russian variants given in brackets:

opportunity, employer, do not hesitate, enclose, as stipulated, freight movements, available, due to personal reasons, well-run, at your earliest convenience, advertisement, accommodation expenses, challenge, asset, performance-related salary, division, preliminary, previous experience, department, team, with reference to, responsible, in excess of, referees, suitable, notified, curriculum vitae, short-listed candidates, contribute, currently, enclosed, improvement, employers, further

1. I am writing in reply to your (объявление) in the European News for the post of Sales Manager in your European (отдел).
2. I (прилагаю) a full (резюме, краткая биография) and the names of two (поручители) (как требуется).
3. My current (зарплата в зависимости от достижений) is (свыше) £ 30K p.a.
4. I look forward to your reply (как можно скорей).
5. I have held this post for three years now and would welcome an (возможность) to work in Britain.

6. I am (в настоящее время) employed as Freight Coordinator and I am (ответственный) for (перевозка грузов) to and from the US and Britain.
7. Travel and (расходы на жилье) will be borne by the company.
8. We are inviting (подходящий) candidates to attend for a (предварительное) interview on the Saturday.
9. All (кандидаты, прошедшие первичный отбор) will be (известны) approximately 10 days after interview.
10. We (не колеблясь) to recommend her to any future (наниматель).
11. (Касательно) your advertisement I should like to apply for the job of Supplies manager.
12. (По личным причинам), I have to move to London within the next month.
13. I think my (предыдущий опыт) will be an (ценное качество) and that I could (вносить вклад) significantly to your (команда).
14. References are (имеются в наличии) from my present and previous (работодатели).
15. Please find (в приложении) a copy of my CV for your (дальнейшей) information.
16. I have always enjoyed the (вызов, проблема) of a (хорошо организованный) supplies (отдел) and the constant need for (улучшение) and value analysis.

## 24. SUPPLIER REJECTS ORDER

*Fill in the gaps with the appropriate word combination from the box.*

a wide variety	receipt
can be processed	regret
gone out of business	to accept
latest catalogue	

12 August 20..  
England

Dear Mr Marshall

We confirm \_\_\_\_\_ of your order for two Vox Z1 47 synthesisers but \_\_\_\_\_ having to inform you that Vox Ltd have now \_\_\_\_\_ - thus making it impossible for us \_\_\_\_\_ your order.

There is \_\_\_\_\_ of similar instruments on the UK market, however, and for your information we enclose our \_\_\_\_\_ and price list.

At present orders for the instruments listed \_\_\_\_\_ within 4 weeks of receipt of order.

Assuring you of our best attention at all times we remain.

Yours sincerely

Terry Webb

Export Sales

### *Vocabulary*

confirm receipt – **подтвердить получение**

go out of business – **прекратить дело, уйти из бизнеса**

process an order – **обработать заказ**

---

*One of the graduates of the BNTU wrote an application letter in response to the advertisement in one of the issues of Transportation Monthly Journal. You have been already asking for a Job for nearly a **month. Recently you've come across an appropriate advertisement** in the newspaper in which they announced an opening vacancy for logistician in their company. Write your own letter of application.*

145/89 Independence Ave

Minsk, 22019

26 December 2010

Ivan Ivanov

Ltd Astra Belamsia

56 Nekrasova Ave

Minsk, 220015

Dear Mr Ivanov

I'm writing in response to your advertisement in the December issue

of Transportation Monthly Journal in which you announced an opening for freight forwarder in your company. I think that I'm the right sort of person for the post because my qualification and experience are appropriate.

I have graduated from the Belarusian National State University in Minsk with a Master's degree in International transportation of cargos and passengers. I am fluent in English and German. I am currently studying for a certificate in warehousing logistics at Belarusian State University as a part time student. For the last three years I have had a full time job at Intertransportation Ltd.

I am submitting the summary of my qualifications and experience, together with copies of three recent references. Enclosed is a copy of my resume for your consideration. If you have any questions or wish any additional information, please, feel free to let me know.

Thank you for consideration.

Sincerely yours,

---

1. Read the following letter of reply and choose the best words from the options in brackets.

Dear Mr Konrad

We were very pleased to receive your (*correspondence, enquiry, mail*) of 14 October 2011, asking about our tires (*range, cloths, products*) and terms of (*dealing, trade, conditions*).

First let me say that our (*label, mark, patent*) is internationally famous because of the quality of our products, and we are convinced they will sell very well through your (*outlets, factories, warehouses*). We think you will agree with us when you look through the enclosed (*manual, catalogue, leaflet*) and forwarding separately.

You will see from the price-list that we take care of all freight and insurance costs, so the prices are quoted on a(n) (*c.i.f, ex-works, fo.b.*) basis. We will also allow (*trade, cash, quantity*) discounts for orders over \$10,000, and with the usual trade references, we can arrange for payment by 60-day (*bill, letter, draft*) of exchange.

Thank you once again for your enquiry, and we are sure you will be impressed by the (*vast, huge, wide*) selection of our items. Meanwhile, if there are any further details you need, please contact us.

Yours sincerely,  
Sales Director

2. *Choose the best alternative to complete the sentences.*

1. The bookkeeper keeps a record of every financial \_\_\_\_\_ .  
a) action      b) transaction      c) entry      d) transcription
2. **It's essential to \_\_\_\_\_ the invoice number in any correspondence.**  
a) estimate      b) quote      c) say      d) tell
3. **We send a \_\_\_\_\_ to customers who haven't settled their accounts.**  
a) reminder      b) remainder      c) remembrance      d) memory
4. This company has a weekly \_\_\_\_\_ of about \$100,000.  
a) pay      b) turnover      c) salary      d) wage
5. Often a discount is offered as an \_\_\_\_\_ to get a customer to pay promptly.  
a) investment      b) incentive      c) interim      d) inventory
6. **Check the \_\_\_\_\_ note and see that you've got everything.**  
a) deliver      b) delivered      c) delivery      d) delivering
7. **I've just received an \_\_\_\_\_ note telling me that the goods have been dispatched.**  
a) advice      b) advise      c) invoice      d) advisory
8. The task of the public relations department is to project the right \_\_\_\_\_ of a company.  
a) painting      b) image      c) picture      d) drawing
9. When making a presentation to a relatively small \_\_\_\_\_ an overhead projector can be invaluable.  
a) assistance      b) spectator      c) audience      d) congregation
10. Because of high shipping costs, it made more sense to \_\_\_\_\_ a manufacturer to produce our range of furniture.  
a) license      b) lease      c) control      d) handle
11. The government has imposed protective traffic to stop the \_\_\_\_\_ of cheap imports when threatened to destroy domestic industries.  
a) rain      b) famine      c) flood      d) storm

12. The technical \_\_\_\_\_ for electrical equipment can vary from country to country.

a)justification                      b)rules              c)specifications              d)uniforms

13. Among other things, a \_\_\_\_\_ contains details of the goods, their destination and the name of the ship carrying them.

a)bill of lading                      b)way-bill              c)bill of exchange              d)receipt

14. The person the goods are sent to is called a \_\_\_\_\_ .

a) consignor    b)consignee    c)commissioner              d)master

15. She looked at the \_\_\_\_\_ to check where the goods were produced.

a)certificate of origin    b)test certificate              c)postmark              d)trademark

*3. Join the beginning of each phrase with the appropriate ending.*

1. Following your advertisement in the "Daily"...

2. Please find enclosed...

3. We regret to inform you that...

4. We look forward to...

5. We acknowledge receipt of...

6. Please accept our sincere apologies...

7. I am writing...

8. Should you require any further information...

9. We would be grateful if you could...

10. We would be very interested in receiving...

11. I would like to reserve...

12. Should you be interested...

a. ... your order will be one week late.

b. ... your letter dated 12th January 2010.

c. ... please do not hesitate to contact us.

d. .... a visit from your salesman.

e. .... to enquire about your range of software.

f. .... send us a quotation for 20 items.

g. ... in taking the matter further...

h. ... I am writing to apply for the position of...

i. .... a double room in the name of Smythe.

j. ... doing business with you in the near future,

- k. .... for the inconvenience you have been caused.
- l. .... a copy of our brochure and price list.

4. *Put the phrases in the right order.*

- a) to you look I meeting forward
- b) to delivery am I confirm writing
- c) enclosed find please
- d) of your 15th you letter thank for April
- e) sincerely yours
- f) regards with best
- g) information you any require further should
- h) letter please of receipt this acknowledge
- i) hesitate us to contact do please not
- j) to catalogue shall send we be you our pleased

5. *Study the following e-mail as an example.*

From: beltrans@tut.by  
To: [Robertdel@aol.com](mailto:Robertdel@aol.com)  
Subject: \_order no. VF449766 of 4 July 2011

This transmission contains information which maybe confidential. It is intended for the named addressee only. Unless you are the named addressee, or authorised to receive it on behalf of the addressee, you may not copy or use it, or disclose it to anyone else. If you have received this transmission in error, please contact the sender. Thank you for your co-operation.

Dear Sirs,

The goods ordered under this number arrived today in good condition and your invoice - has been checked and found correct.

However, we have to point out that these articles were ordered subject to their arriving here by the end of August. Since they did not reach us until 14 September, we have been hard pressed to meet our commitments to our own customers.

As you will no doubt understand, a recurrence of this situation could well result in our customers placing orders elsewhere, and this is a risk we are unwilling to take. We must, therefore, insist that you observe delivery deadlines for future orders.

Yours faithfully

6. Now write a reply to this e-mail. Use the following phrases to help you:

Thank you for your email I'm writing to .... I'm very sorry about Could you ....?	I'm sending you .... I hope that... Let me know if ... Best regards/wishes.
--	--

7. Write this **customer's complaint of repeated delays delivery** in the form of email.

Dear Sirs

Our order nos. 6531, 6687, 6866 and 6892

As we have repeatedly pointed out to you, prompt delivery on your part is essential if we are to maintain satisfactory stock levels and fulfil our production schedules. Each of the four orders listed above has arrived later than the date stipulated, and order no. 6892 was delayed by almost a month, with the result that we have had to reduce production by some 5 per cent.

We cannot possibly allow this situation to continue, and are sorry to have to tell you that unless you can guarantee to deliver supplies by the dates specified in future orders, we will be forced to look for another supplier. We hope to hear from you very soon.

Yours faithfully



7. Do the following task:

You work for a company that manufactures car parts. You receive the email below from a French customer. Complete the email with the words from the box.

appreciate, attachment, forward, possible, sending, unfortunately, writing
---

From Perry, Yves <ypery@sr.g.fr>  
To frieda.benn@dashpen.co.uk  
Subject order no.7H325K

Dear Ms. Benn

I'm \_\_\_\_\_ to you because of a problem with the delivery which we received from you last week. The order was for 1000 dashboard panels. \_\_\_\_\_ 50 of the boxes that arrived were empty. Can you send us the missing items as soon as \_\_\_\_\_. We would also \_\_\_\_\_ it if you **could look into the problem to make sure this does not happen again.** I'm \_\_\_\_\_ you a scan of the delivery note as an \_\_\_\_\_.  
I look \_\_\_\_\_ to hearing from you soon.

Best regards  
Yves Perry

Now write a reply to the email. Use the phrases to help you.

Thank you for your email I'm writing to .... I'm very sorry about Could you ....?	I'm sending you .... I hope that... Let me know if ... Best regards/wishes.
--	--

8. Netiquette. Study the following rules.

1. Don't type everything in capitals. (People may think you are shouting!)
2. Use "smileys" when you want to give a nuance.

3. Limit line length to 65-70 characters.
4. Think carefully about what you write - it is a written record, not a telephone call!
5. Don't waste bandwidth - what you write should be to-the-point.
6. Warn the recipient if you want to attach a large file.
7. Write descriptive subject lines so the receiver knows what to expect.
8. When replying, don't quote back the whole message - delete the excess.
9. When forwarding a message, put any comments you have on the top.
10. Don't overuse acronyms, smileys, or internet expressions - not everyone will know what you are talking about.
11. Use a spell checker or be sure of your spelling.
12. Read through your e-mail before sending it - it may be informal but you still have to be clear and concise.

*9. Choose the right definition*

1. E-business	Economic business Electronic business
2. T-commerce	Total commerce Television commerce
3. C2B	Customer to business Client to boss
4. B2B	Buyer to boss Business to business
5. IMO	International monetary organiza- tion in my opinion
6. IMHO	In my humble opinion International monetary help organ- ization
7. OTL	Over the limit Out to lunch
8. HSIK	How should I know Have something in kit
9. BBL	Bring back later Be back later

10. TTYL	Talk to you later The time you left
11. NOYB	Not only your business None of your business
12. FWIW	<b>For what it's worth</b> Full with internet words
13. IRC	Internet relay chat Internal relay comment

**10. While applying for a job it's obligatory to submit CV. Study the main point of CV.**

## THE CURRICULUM VITAE

*Your CV should be:*

- word-processed
- laser printed on good quality paper
- no longer than two pages of A4 paper

*You should include:*

1. Personal details

The employer wants to know who you are and how to contact you (essential information only).

2. Education

Don't go too far back in time or leave any gaps.

3. Work experience

Don't just describe the job - stress what you achieved and what you learnt. Put your most recent experience first.

4. Positions of responsibility

If you do not have a lot of work experience, this section will show employers **your potential or miss this section out if you haven't had a** position of responsibility.

5. Skills

Be positive about your ability - never undersell your experience.

6. Interests

Stress any significant achievements related to your interests.

**Don't just list** your interests – add a few details.

7. Referees

Current students and recent graduates should choose an academic referee and a personal one (this could be an employer).

Get your referees' permission first and tell them what you are applying for and what you would like them to stress in a reference.

11. Look through the given CV and make up your own one.

### Curriculum Vitae

		Svetlana Popova Born 9. Novemembr 1988, Minsk, Belarus Address Independence Av, 115-29 Minsk, 220015 Tel.:375173347028 Email <a href="mailto:svet_popova@tut.by">svet_popova@tut.by</a> Nationality: citizen of Belarus Marital status: single, no kids School Education
09/1995	–	<b>School №4, Minsk, with focus on Music Studies</b>
11/2000		
12/2000-		<b>Gymnasium №7, with school leaving certificate, Minsk,</b>
06/2006		advanced English studies
		Higher Education
09/2006-		Belarusian National Technical University, Minsk
02/2010		<u>Study Programme:</u> World Economy, Transport Logistics <u>Major:</u> World Economic Relations, Logistics in Transport, Foreign Languages (English, German) <u>Degree thesis:</u> “ <b>Management of Road Transport in Brest region</b> ” <u>Mark:</u> 8 (Good)
09/2010	–	University of Applied Science (FH) Leipzig (DAAD
07/2011		Scholarship) <u>Bachelor Programme:</u> European Business Studies <u>Major:</u> Logistics, Marketing

12/2010-05/2011	<p>Work experience Bentlintertrans, Minsk, Belarus, Department of Marketing and Logistics Referent (part-time)</p> <ul style="list-style-type: none"> <li>- Organization and preparation of marketing concept of the company</li> <li>- Preparation, implementation and evaluation of company's participation in <b>International Agricultural Exhibition "Belagro" 2010 in Minsk</b></li> <li>- Translation of various booklets and folders and participation in negotiations with foreign partners (Germany, Russia, Ukraine)</li> </ul>
07-08/2009	<p>Hotel Palace, Italy, Public Relations Department/Trainee</p> <ul style="list-style-type: none"> <li>- Communication with hotel guests</li> <li>- Reception of VIP clients</li> <li>- Preparation, implementation, evaluation of events in hotel</li> <li>- Quality management</li> <li>- Implementation of promotion events</li> </ul>
09-12/2010	<p>Joint marketing project (Development of Web 2.0 concept for the new brand B2) between BNTU and Berentzen-Gruppe AG.</p>
11/2010	<p>Other activities</p> <ul style="list-style-type: none"> <li>- Participation in Belarusian Agricultural Exhibition <b>"Belagro" in Minsk</b> as a hostess and interpreter</li> <li>- <b>Participation in the International Fair "Agrotechnika 2010" in Germany as interpreter</b></li> <li>- Assistance in organization of X Minsk Forum by German-Belarusian Partnership</li> </ul>
	<p>Capabilities</p> <p>EDP</p> <ul style="list-style-type: none"> <li>- MS-Office (good)</li> <li>- Adobe Photoshop Elements (basics)</li> </ul> <p>Languages</p>

References | - Russian (mother tongue), English (fluently, Level B2, TOEFL iBT 103)  
Hobbies  
foreign languages, sport (swimming, tennis), literature, music, travelling, meeting new people and cultures  
Available upon request  
Minsk 14, June, 2011

*12. Study the Cover Letter.*

3200 Inglewood Ave.  
St. Louis Park, MN 55416  
11 May 2011

General Mills, Inc.  
P.O. Box 9452  
Minneapolis, MN 55440

To whom it may concern,

I am writing to apply for the Internal Marketing Communications Consultant position. I learned of this opportunity from a relative, Roger Toutloff, an employee at General Mills. As a recent graduate from the College of Saint Benedict, my education, international background, and skills lead me to be an excellent candidate for your position.

During my undergraduate education, I realized I had a growing passion for Marketing and Public Relations. The combination of coursework and external experience from previous jobs and internships has allowed me to learn, grow, and develop skills and abilities that can help me thrive and succeed within your company. As an Assistant Marketing and Sales Manager, I was responsible for updating websites and social media, organizing and planning events, writing and editing press releases, as well as meeting with advertisers to increase sales.

My greatest accomplishment thus far has significantly contributed to my marketing background. Last year I received a scholarship to study and work in Germany. I took business classes at a university and worked

for a large international paper and print production company. During my internship, I was responsible for managing a marketing team of 15 members and reported directly to the CEO/founder of the company. As a member of a team, I assisted in branding the product and affiliate company. I ensured that all projects were handled smoothly and reached their proper deadlines in a timely manner. This experience also allowed me to expand my critical thinking skills and explore my creative side as we developed a new image for the company.

Not only have I developed hard skills to further my career, in addition, my experiences have afforded me with intangible qualifications including resourcefulness, adaptability, interpersonal effectiveness, and integrity. I am young yet mature and very willing and eager to learn new skills and abilities. I would greatly appreciate the opportunity to meet and discuss the contribution I could make at General Mills.

Thank you for your time and consideration.

Sincerely,  
Maren C. Gotchnik

*13. Translate the following sentences and use them while writing business and commercial letters:*

1. We trust that you will receive the goods in perfect condition and remain at your service for further deliveries at any time.

2. We ask you to send us a pro-forma invoice and include the following details: exact description of the goods; unit and total price with discounts; terms of payments and delivery CIF Calcutta; packing list.

3. We hope that there will be no reason for delay of any sort and look forward to our order being shipped as agreed.

4. Should any delay arise or any change in procedure proves necessary, we will notify you as appropriate.

5. We regret the inconvenience caused and feel you acted correctly by having the damage assessed by your insurance agent.

6. We trust the matter will be settled to your satisfaction in due course.

7. Due to personal reasons I have to move to London within the next month.

8. I think my previous experience will be an asset and that I could contribute significantly to your team.
9. References are available from my present and previous employers.
10. Please find enclosed a copy of my CV for your further information.
12. I have always enjoyed the challenge of a well-run department and the constant need for improvement and value analysis.

#### *14. Assignments for writing business and commercial letters.*

1. Design a letter heading for a company manufacturing washing machines, refrigerators and other household equipment. Include all the information about your company which is normally shown in a modern letter heading.

2. Write a letter of enquiry on behalf of your firm to the Yorkshire Woollen Company, Bradford, asking for patterns of cloth for men's suits.

3. Write to the import agent for RITESWIFT typewriters, enquiring about prices, delivery dates, and any other facts which you, as a prospective customer, would be interested in.

4. Your firm is a Swiss manufacturing company and is in urgent need of certain metal fittings which cannot be obtained quickly enough from the normal suppliers. Write an enquiry to a British maker of these fittings.

5. An enquiry has come to your company, a firm of watchmakers, from a British retailer. Write a reply to send with your price-list. Quote your terms, and add any information you consider might induce your correspondent to place orders with you.

6. Write to a firm of shipping agents in England and ask them to quote you for the collection of some cases of tools from a firm in Birmingham, and the shipment to your nearest port.

7. As a firm of forwarding agents you have been asked to advise on the forwarding of a consignment of bicycles. Write a suitable letter and ask by what route the bicycles are to be sent; give your advice on the matter.

8. You have been asked to arrange for a consignment of goods by train-ferry; reply to the letter and point out that the consignment must be over 1 ton in weight. Advise alternative routes.

9. Write a letter to your customers informing them what arrangements you have made for the transport of a consignment of chemicals. Your customers may be in America or another country outside Europe.



10. Write to a firm of shipping agents and ask them to take charge of a consignment you have shipped to an overseas country; say who will take delivery of the goods.

11. Answer a foreign letter of enquiry which your firm has received following an exhibition of your sewing machines at a trade fair in Brussels.

12. Write a letter based on these notes:

thanks for order (no., date)—goods despatched (ship, date due) — invoice enclosed—goods carefully selected—packed crates—safe arrival—excellent value—hope good sales—rely on us—at your service.

13. Your firm has received an order for machine tools from an overseas buyer. Write a letter of acknowledgement and promise delivery by a certain date.

14. Write a letter to a foreign manufacturer of some article you are familiar with. Enclose an order and state your requirements regarding quantity, quality, appearance and delivery.

15. You have seen samples of Finnish wine glasses at a trade fair, and would like to import a large quantity of them. However, you have heard that the manufacturer in question tends to pack his products rather carelessly, with the result that consignments often include large numbers of broken glasses. You have also heard that crates often arrive late because of insufficient marking.

16. Discuss with your fellow-students how wine glasses should be packed, and then send an order to the Finnish manufacturer, giving detailed instructions as to how the goods are to be packed and the containers marked.

17. Answer an enquiry for industrial chemicals, quoting prices of various containers, sizes, and method of packing.

18. Send an order for goods your firm requires from a foreign supplier and ask for pro-forma invoice.

19. Write a letter in which you ask your suppliers for an extra 21% discount on an order for 10,000 tins of meat extract. Write also the supplier's letter (a) granting, and (b) refusing this request.

20. Write to ship brokers and ask them to charter a ship for the loading of a cargo of fertilisers; give them necessary particulars about port and time.

21. Write a letter for an overseas importer of hardware, in which you order goods from a British manufacturer's catalogue. Say how you wish to pay, as your firm has not yet done business with the seller.

22. Send a letter to a firm in an English-speaking country asking them to supply you with goods on better terms of payment. At present you are accepting drafts at 30 days.

23. A foreign customer has been buying from your firm for a year and has honoured your sight drafts on presentation. He now asks for open account terms with quarterly settlement by B/L.

Write two letters:

a) one agreeing to his request and

b) one asking for an irrevocable letter of credit covering the amount of his quarterly requirements.

24. Write to the office of British Airways and ask for particulars of freight, insurance, etc., on a consignment of watches and clocks.

25. As the exporters, write a tactful letter to customers who have complained that the material they have received is not like the samples on which they gave the order.

26. Your firm wishes to appoint a main agent in South America for the sale of its well-known optical instruments. Write a letter to a South American distributor and offer the agency.

Учебное издание

БОЯРСКАЯ Анна Олеговна  
ПЕДЬКО Людмила Владимировна  
СЛЕСАРЕНОК Екатерина Викторовна

TRANSPORT BUSINESS DOCUMENTATION

Пособие

Технический редактор Д.А. Исаев  
Компьютерная верстка Е. В. Слесаренок

---

Подписано в печать 07.07. 2011.

Формат 60X84 1/16 .Бумага офсетная.

Отпечатано на ризографе. Гарнитура Таймс.

Усл. печ. л. 6,39. Уч. - изд. л. 5,0. Тираж 100.

Заказ 597.

---

Издатель и полиграфическое исполнение:

Белорусский национальный технический университет.

ЛИ № 02330/0494349 от 016.03.2009.

Проспект Независимости, 65. 220013, Минск.

Министерство образования Республики Беларусь  
Белорусский национальный технический университет  
Кафедра английского языка № 1

Боярская А.О.  
Ладутько Н.Ф.  
Митьковец Т.Е.

## SPOKEN ENGLISH FOR TRANSPORTATION

Минск 2012

УДК 811.111(075.8):005

ББК 81.2Англ.

Б86

**Рецензенты:**

старший преподаватель кафедры делового английского языка  
ФМБК БГЭУ Л. И. Василевская;

зав. кафедрой организации автомобильных перевозок и дорожного  
движения, доктор технических наук, профессор В. А. Грабауров.

**Боярская, А. О.**

Spoken English for Transportation / А.О.Боярская, Н.Ф. Ладутько,  
Т.Е. Митьковец. – Мн.: БНТУ, 2012. –77с.

Настоящее пособие предназначено для студентов старших курсов автотракторного факультета специальности «Организация перевозок и управления на автомобильном и городском транспорте». Целью пособия является обучение студентов навыкам разговорной речи в условиях профессиональной деятельности. Тематика уроков отражает профессиональные ситуации общения будущих транспортных менеджеров. Основная часть пособия посвящена разговорным упражнениям на закрепление лексики, грамматических структур, развитие диалогической/монологической речи по специальности. Материал пособия построен на аутентичных диалогах и текстах и представляет собой практический интерес для будущих специалистов автотракторного факультета в области логистики.

УДК 811.111(075.8):005

ББК 81.2Англ

© Боярская А.О., Ладутько Н.Ф.,  
Митьковец Т.Е., 2012  
© БНТУ, 2012

## UNIT 1. TELEPHONING. ANSWERING A CALL

1. Discuss the questions below with a partner.

1. Could you live without your mobile phone?
2. How many phone calls do you usually receive and make a day?
3. Who do you call most often?
4. Have you ever let the telephone ring without answering it?
5. Have you ever dialed the wrong number?
6. Do you think telephone etiquette differs in different countries and cultures (speaking clearly and slowly, smiling, no interrupting, no eating or chewing gum, letting the caller hang up first, no calling before 8:00 am or after 9:00 pm)?
7. Have you ever made phone calls in English?
8. What do you find most difficult about telephoning in English?

2. What is required in preparing to make a call? Study the following notes and discuss them with your partner.

➤ If you have to make a difficult phone call, spend a few minutes preparing first. Think about what you want from the phone call – any questions you need to ask or things you need to say. What might the other person say? Make notes of English phrases you can use during the call.

➤ Sometimes receiving an unexpected call can be very stressful. To give yourself some time to prepare for the call, you might want to tell a 'white lie' (*I'm sorry, I'm actually in a meeting right now. Can I call you back in ten minutes?*) and call back when you feel more confident.

➤ Prepare the desk – paper, pen, any relevant documentation, computer files, etc. Have your diary on hand, so you can fix appointments.

➤ Check recent correspondence, **know exactly what's going on**.

➤ Read out phone numbers as individual digits:

*051778 = oh (zero/nought), five, one, seven, seven (double seven), eight.*

3. Read the conversation between Mark, an employee from Trivesco, and Amy, a receptionist from an American shipping company. Using the phrases below, make improvements to it.

✓ Be ready to answer the questions after this conversation.

- a) *Is that right?* f) *Can I do anything else for you,...*  
 b) *Sorry but...* g) *Yes, please.*  
 c) **Could you ...** h) *Of course,*  
 d) *Just a moment, please.* i) *Certainly.*  
 e) *Thank you.* j) *How may I help you?*

Amy: Hello, Daneline Ltd. This is Amy. <sup>1</sup> \_\_\_\_\_

Mark: **Hi, Amy. My name is Mark Wrent. I'm calling for Sylvie Peter-**  
 sen.

Amy: <sup>2</sup> \_\_\_\_\_

Mark: All right.

*Holding.*

Amy: Thanks for holding. <sup>3</sup> \_\_\_\_\_ Sylvie is not in at the moment. Would  
 you like to leave a message?

Mark: <sup>4</sup> \_\_\_\_\_. <sup>5</sup> \_\_\_\_\_ tell her that Mark Wrent from Trivesco called? Our  
 shipment will be postponed and the 100 furniture items ordered should  
 arrive next Monday.

Amy: **Shipment delayed ... arriving next Monday.**

Mark: Yes, and could you ask her to call me back on my cell phone  
 when the shipment arrives?

Amy: <sup>6</sup> \_\_\_\_\_ Mr Wrent. Could you give me your number please?

Mark: <sup>7</sup> \_\_\_\_\_ **It's 390-929-191.**

Amy: **That's 390-929-191.** <sup>8</sup> \_\_\_\_\_

Mark: **Yes, that's right.**

Amy: <sup>9</sup> \_\_\_\_\_ Mr Wrent?

Mark: No. <sup>10</sup> \_\_\_\_\_

Amy: You are welcome.

Mark: Bye now.

Amy: Bye.

*"How may I help you?"* is more  
 formal than *"How can I help you?"*

<i>British English</i>	<i>American English</i>
<i>The line is engaged. mobile (phone)</i>	<i>The line is busy. cell (phone)</i>
<i>She's on holiday. to ring/to phone someone</i>	<i>She's on vacation. to call/to give someone a call</i>

- ✓ What information does Amy include in her first sentences?
- ✓ How does Mark introduce himself?
- ✓ What information does Mark include in his message?
- ✓ What phrases does Amy use to confirm the information she gets from Mark?

4. Read these useful telephoning phrases and make sure you understand them. Which ones can you use:

- a) *to say what you want*
- b) *to say that someone is not at the number you called*
- c) **to say that somebody can't talk now**
- d) *to leave or to take a message*
- e) *to confirm the information*
- f) *to end the conversation*

- 1) It was nice talking to you, Mr Smith.
- 2) **I'm sorry but he doesn't** work here anymore.
- 3) **All right. So that's 3-4-5.** Is that right?
- 4) **I'm afraid** she is on maternity leave.
- 5) Thank you for calling, Mr Smith.
- 6) **Sorry, she is in a meeting. I'll ask** her to ring you back.
- 7) I look forward to hearing from you soon.
- 8) Could I have the Customs Clearance Department, please?
- 9) Could you tell him that Susan rang?
- 10) Could I leave a message, please?
- 11) **I'd like to speak to someone about** the loading, please.
- 12) **I'm afraid he is** out of town. You can reach him on his mobile.
- 13) **I'm sorry we don't have anybody here** by that name.
- 14) **I'm afraid his/her line is engaged. Can you hold** on or would you like to ring back later?
- 15) I see. So you mean you will arrive at 7.30. Right?
- 16) **He's not at this number any longer. His new number is 122 078.**

5. What would you say in these situations? Use the phrases from ex.4. More than one answer is possible.

- 1. Your female colleague is off work as she has just had a baby. What do you say to the caller who wants to speak to her? .....
- 2. You call a transport company to find out the loading date of your goods. **You don't know the name of the person responsible for this.** What do you say? .....
- 3. You pick up the phone. The caller is calling for Mr Wilson. Mr Wilson doesn't work at your company. **What do you say?** .....



4. You are taking a message. What do you say to confirm the information you have received from the caller? .....
5. You pick up the phone. The caller is calling for Miss Smith. Miss **Smith doesn't want to be disturbed. What do you say?** .....
6. You pick up the phone. The caller is calling for Mr Black. Mr Black is on a business trip. **What do you say?** .....

6. Make the phrases below less direct, as in the example.

*When asking questions on the **phone in a business context** it's important to be polite and not too direct. Could and would are more polite than can. e.g. Could you place that order today, please? Would you mind sending me the details? or Can you tell me where you're calling from, please?*

*Person making the call*

1. Jason Wright. – *This is Jason Wright (speaking).*
2. I want to speak to Carol Nelson.
3. Take the message.
4. Speak loudly.
5. Tell her to call me back.

*Person answering*

6. Who are you?
7. What do you want?
8. Spell your name.
9. Repeat the name of your company.
10. Give the number of your mobile phone.
11. Stay on the line.

7. Study the phrasal verbs and make sure you understand them.

to hold on = to hang on = to wait - to keep a telephone line open  
 to hang up = to ring off (BrE) - to end a telephone call by replacing the receiver  $\neq$  to ring somebody up  
 to put somebody through - to connect your call to another telephone  
 to get through to - to try to get somebody on the phone  
 to pick up *the phone* or to pick *the phone* up- to answer a telephone call

to ring back (BrE) = to call back (AmE) - to return a telephone call - *if you use an object (you, me, him, her etc.), it goes in the middle of the verb: I'll ring you back.*

8. Complete the sentences using the appropriate phrasal verb from ex.7. Pay attention to the place of the object.

1. I'll **\_\_** you to the International Shipping department.
2. I'm **trying to connect you**. Could you **\_\_**?
3. I'm calling him, but he just isn't **\_\_**!
4. If we're not around she'll take a message and we'll **\_\_** you.
5. I called her on the phone time after time, but I couldn't **\_\_** her.
6. I said good-bye and **\_\_**.
7. Can you **\_\_** for a minute?
8. Tell her I'll **\_\_** in a few minutes.
9. I **couldn't** **\_\_** the office because the telephone line was down.

9. Complete the sentences with a preposition (*about, at, by, in, on, through*).

1. Sorry, we have nobody **here** ... that name.
2. **You can reach him** ... **his mobile**.
3. **I'll call you** ... ten minutes.
4. **Could you hold** ... a little longer?
5. When are you **going** ... holiday?
6. **I'm calling** ... the order I placed last week.
7. **Please call me** ... my mobile phone.
8. Sorry, **he's** ... a meeting.
9. Could you **stay** ... the line, please?
10. **I'm afraid she is** ... sick-leave.
11. **Could you call him** ... **this number**?
12. I'll see if I can put you ....

10. Study the following notes and discuss them with your partner.

It is very common to use *I'm afraid* or *I'm sorry* when giving 'bad' news, for example when saying someone is not available.

*I'm afraid Mr Clark is in a meeting.*

*I'm sorry, but Mr Clark is out for lunch.*

The word *actually* is also often used to make a statement more polite.

For example, it can be used:

✓ instead of saying the word *no*.

A: *Does he have your phone number?*

B: *Actually, I don't think he does.*

✓ when we change the subject (e.g. when we change from small talk to talking business). *Your holiday sounds fantastic. Listen, Sandra, I actually wanted to speak to Maria.*

✓ to say something which is inconvenient or annoying for the other person, in a polite way. *Can I call you back? I'm actually talking to someone else on the other line.*

11. Make the underlined sentences more polite using the notes from ex. 10.

1. I'm trying to get through to Jake Woodward. He asked me to call him this morning.

2. OK. That's 3-0-3. Have I got that right? – No, it's 3-0-4.

3. Could I speak to Kevin Wilson? – He's away on holiday.

4. Would you like to leave a message? – No, I'll call back later.

5. Sandra's line is engaged. Shall I tell her to call you back?

6. Is Anna there at the moment? – No, she is having lunch now.

12. Match up the halves to make questions.

- |                      |                            |
|----------------------|----------------------------|
| 1) Could I speak     | a) my mobile number?       |
| 2) Can I leave       | b) through to her?         |
| 3) Could you ask     | c) have your number?       |
| 4) Could you tell me | d) back in ten minutes?    |
| 5) Does Mr Newton    | e) your name again?        |
| 6) Is she there      | f) a message?              |
| 7) Shall I put you   | g) ask what it's about?    |
| 8) Can I just        | h) at the moment?          |
| 9) Can I call you    | i) to Pall Miller, please? |
| 10) Have you got     | j) him to call me back?    |
-

13. Now match these responses to phrases 1-10 in ex.12. More than one answer is possible.

- |                           |  |
|---------------------------|--|
| A) Certainly.             | G) Yes, she is.                                |
| B) Yes, he does.          | H) I'm afraid he's in a meeting.               |
| C) Sure, no problem.      | I) I need to ask her about the shipping rates. |
| D) My name is John Ellis. | J) Yes, please.                                |
| E) Yes, I have.           |  |
| F) That would be great.   |  |

✓ Make up short dialogues using the phrases from ex. 8-13.

14. Complete the dialogue and role-play it with your partner.

- Snapple Ltd., good morning, Monica <sup>1</sup> \_\_\_\_\_. Can I <sup>2</sup> \_\_\_\_\_ you?
- <sup>3</sup> \_\_\_\_\_ to Carlos Santana please?
- **Can I ask who's** <sup>4</sup> \_\_\_\_\_ please?
- Brad Caroli.
- One <sup>5</sup> \_\_\_\_\_ please.  
(pause)
- Sorry, his line is <sup>6</sup> \_\_\_\_\_. Would you like to <sup>7</sup> \_\_\_\_\_?
- Yes, could <sup>8</sup> \_\_\_\_\_ **that Brad Caroli called. That's b-r-a-d new word c-a-r-o-l-i.**
- <sup>9</sup> \_\_\_\_\_.
- Yes, **and the meeting's been rescheduled for next Tuesday, that's Tuesday, the thirteenth.**
- <sup>10</sup> \_\_\_\_\_.
- Yes, **that's right. If there are any problems he can** <sup>11</sup> \_\_\_\_\_ me on my mobile phone. <sup>12</sup> \_\_\_\_\_ 0338-301-4467.
- **All right. That's 0338-301-44...?**
- 4467.
- 4467, OK. **I'll make sure he** <sup>13</sup> \_\_\_\_\_.
- Can <sup>14</sup> \_\_\_\_\_ for you, Mr Caroli?
- No, <sup>15</sup> \_\_\_\_\_.
- You are welcome.
- <sup>16</sup> \_\_\_\_\_.

15. Use the following flow chart to make a telephone conversation.

<i>Caller</i>	<i>Receptionist</i>
	“ <b>Good morning</b> , Lewis and Zimmerman. Sam/Samanta is speaking. How can I help you?”
Introduce yourself. Ask to speak to Mr Conrad Bird.	
	Mr Bird is not in. Give the reason. Offer to take a message.
You want Mr Bird to call you. Repeat your name, the company you work for and the reason you are calling. Give your number.	
	Confirm the information.
Correct the wrong information.	
	Offer your help.
End call.	

## UNIT 2. TELEPHONING. COMMUNICATION PROBLEMS

1. When speaking on the phone sometimes we have to mention symbols. Check if you know them. Match the symbols below with their meanings (1-14).

#	@	*	-	‘	_	/	(	\	)	,	&	.	:
---	---	---	---	---	---	---	---	---	---	---	---	---	---

- |                  |                    |                     |
|------------------|--------------------|---------------------|
| 1) forward slash | 6) underscore      | 11) comma           |
| 2) dot           | 7) closing bracket | 12) and             |
| 3) colon         | 8) star            | 13) opening bracket |
| 4) hash          | 9) at              | 14) apostrophe      |
| 5) dash (hyphen) | 10) backslash      |                     |

2. Practice saying these email addresses with a partner.

gail@greenfoods.com  
roberto\_garral-91@greenworld.org

yoshi'mura@green-university.edu  
p\_simpson@sc.com  
James-1@web-fix.net  
sam/foreman@new-you.com  
j.fields@office\_pro.com  
*your email address*

3. Study the following notes.

✓ Years

We normally say a year in two parts. In the case of years ending in "00", we say the second part in "hundred": 1900 *nineteen hundred*

1058 *ten fifty-eight*                      1865 *eighteen sixty-five*

1706 *seventeen hundred and six* (or *seventeen oh six*)

There are two ways of saying years ending in "01" to "09" before 2000.

"1901" can be said as "*nineteen oh one*" or "*nineteen hundred and one*".

The year 2000 is read "*two thousand*", 2006 "*two thousand and six*" (AmE: "*two thousand six*"). Post-2010 dates are often said as normal (2010 would be "*twenty ten*").

✓ Dates

*British English*: Write 3 June/3rd June/June 3/June 3rd. Say "*the third of June*" or "*June the third*".

*American English*: Write June 3/June 3rd. Say "*June third*".

✓ Writing dates as numbers

3/6 (or 03/06) means 3 June in *British English*, and March 6 in *American English*. British and American speakers put the month and day in different orders.

✓ Numbers

We write a comma (,) to show thousands (**but we don't say it**):

235,000 *two hundred and thirty-five thousand*

We use a point (.) to show decimals: 1.5 *one point five*

We use the word and after hundreds: *one hundred and eighty-five*

4. Practice saying the numbers and symbols in bold.

1. 2009 was the company's most profitable year since 1998.
2. If your order exceeds 2,000 items, we can offer you a 10% discount.
3. The consignment is due to arrive in Sydney on 10/12/2012.

4. We have received your draft for your invoice **№ 11/367-78**.
5. For more information, call 8 1031 365 233 155.
6. To access the information you require, press the # key, followed by the 0 key, and finally the \* key.
7. It weighs 23.5 tonnes.
8. My email address is e\_heijman@ysu-terra.com.
9. I want to talk to him about my order number EM/1423 dated 12 June.

5. Study the following *active listening strategies* to communicate more effectively on the phone and discuss them with your partner.

✓ When listening, say words like *right, uh huh, got you, yeah* every few seconds to show that you are paying attention.

✓ Check each piece of information that the other person gives you to make sure you understood correctly. You can do this by:

• Echoing, i.e. by repeating what the other person said:

A. *We can deliver on Tuesday.*

B. *Tuesday. Right. / OK, so that's Tuesday. / So you mean you can deliver on Tuesday.*

• Asking for clarification:

A. *Our address is 50 Bloom Street.*

B. *Sorry, did you say 50 or 15? / Sorry, was that 50 or 15? / So that's 50. 5-0. Have I got that correct?*

• Reading numbers and other important pieces of information back to the other person:

A. *My number is 6674 9092.*

B. *Let me just read that back to you. So that's 6674 9092.*

➤ If you are still not 100% sure of what has been said/decided, you can always ask them to send a fax/e-mail to confirm.

6. Read the dialogue. Which active listening strategies from ex.5 do Mr Avdeev and Mr Maier use in their conversation?

- Road Engineering. Alexander Avdeev speaking.
- Hi, Alexander. It's Arno Maier from HCE here.
- Hello, Arno. How are you?

- Not bad, thanks. Listen Alexander, I'm calling about the order you faxed us yesterday.
- Uh huh.
- The delivery address written on the fax isn't very clear, and I just wanted to check it.
- OK. Let me find my copy of the order. One second. OK. Do you have a pen?
- Yes, I do.
- Right. The address is Platonova Ulitsa 1, 220034 Minsk. Would you like me to spell that for you?
- Yes, please.
- OK. It's P-L-A-T-O-N-O-V-A, new word, U-L-I-T-S-A, number 1.
- Let me just read that back to you. It's P-L-A-T-O-N-O-V-A, new word, U-L-I-T-S-A, number 1. Is that right?
- Yes, that's right.
- Sorry, what was the post code again?
- 220034.
- 220034. OK. And Minsk is spelt M-I-N-S-K, is that right?
- Exactly.
- OK. And one last thing. We don't have your fax number and the number on your fax was hard to read. What were the last four digits?
- Mmm. That's 42 14.
- Sorry, did you say 42 14 or 42 40?
- 42 14. 1-4.
- Great. OK, Alexander, I think that was everything. I'll make sure the order gets sent off today. Thanks very much for your help.
- No problem. Speak to you later.

Remember that to clarify spelling, we can use common words (names, cities, countries) to illustrate a letter.  
*That's P for Peter, A for Australia.*

For easily confused numbers (18 and 80), say each individual digit after the number.  
*The number is eighteen – one, eight.*

7. Check that you have understood correctly using the listening strategies from ex.5. Ask about the underlined information. More than one answer is possible.

1. I would like to order 50 units.



2. Our email address is bulatti-sat@gmail.ru.
3. The dialling code for Dublin is 0001.
4. It would take between a week and ten days to ship a consignment there by sea.
5. My phone number is 0912103885.
6. The consignment must be delivered by Thursday.
7. My name is Mikko Tervajoki.
8. The shipping costs for this consignment are £1,570.
9. So the volume would be 30.31 m<sup>3</sup> for the whole consignment.
10. **The goods must arrive at the customer's premises in Selfoss, Iceland, on Friday, August 22.**

dialling code (BrE) area code (AmE)
--

8. There are some more useful phrases which will help you to solve some communication problems. Which ones can you use:

- a) *to ask for clarification*
- b) *to explain a communication problem*
- c) *if you dial a wrong number*

- 1) I must have got the area code wrong.
- 2) **I'm sorry, I can't hear you very well.**
- 3) Was that M for Maxim or N for Nancy?
- 4) Sorry, could you say that again, please?
- 5) **I'm sorry, this is a bad line.**
- 6) **Sorry, it's too noisy here today.**
- 7) Could you speak a little bit more slowly, please?
- 8) Sorry, I think you have the wrong number.
- 9) Could you spell that, please?
- 10) I'm afraid I don't follow you. Could you repeat it, please?
- 11) **Oh, isn't that Veronica Logistics?**
- 12) **I didn't catch what you said.**
- 13) Could you speak up, please?

9. What would you say in these situations?  
Use the phrases from ex. 8. More than one answer is possible.

- 1) You want the person to say his telephone number **again**. .....
- 2) **Someone else has dialled the wrong number**. .....

- 3) You don't know how to write a word. ....
- 4) The phone itself is making a lot of noise. ....
- 5) You want the person to stop speaking so fast. ....
- 6) You want the person to speak louder. ....

10. Choose the appropriate reply to the phrases from ex.8.

- a) Oh. Can I check the number I've got? Is that not 789-654?
- b) Of course. It's W·A·B·S·W·O·R·T·H.
- c) Of course, my number is 798-33-21.
- d) I said we have a meeting arranged for next Monday.
- e) No problem! Bye!
- f) Try calling again later.

11. Match up the sentence halves to make telephoning problems.

- |                                     |   |
|-------------------------------------|---|
| 1) I tried the number 6 or 7 times, | a) tone but no one answered.                    |
| 2) I couldn't get through           | b) line <b>that I couldn't hear him.</b>        |
| 3) She got a ringing                | c) my battery is low.                           |
| 4) We were cut off                  | d) <b>that I couldn't leave a mes-</b><br>sage. |
| 5) There was such a bad             | e) to anyone in the office.                     |
| 6) I need to recharge my mobile,    | f) but the line was always busy.                |
| 7) Your answer machine was so full  | g) before we finished speaking.                 |

12. How would you respond? Use the phrases from ex.11.

- 1) Why **didn't you call me yesterday?**
- 2) So what did he say?
- 3) **Why haven't you left any messages?**
- 4) So have you come to any conclusion?
- 5) **What's happened to your mobile?**
- 6) Have you spoken to Mr Dribb or Mr Peterson from the Warehousing Department?
- 7) Did Marie get through to Asterics Ltd.?

13. Use the following flow chart to make a complete telephone conversation.

<i>Sandra Davis, NDL Inc.</i>	<i>Jake Parek</i>
	"Good morning, Division B.V."
Introduce yourself. Ask to speak to Jake Parek.	
	Offer your help.
Say the reason you are calling (yesterday Jake Parek requested your delivery address and email address but you had been cut off before you finished speaking).	
	Ask the caller to wait while you find a pen.
Give the delivery address (1209 Huntington Avenue, San Francisco, CA 94090).	
	Ask to speak more slowly. Check all the details.
Correct the wrong information.	
	Ask to spell the email address.
Spell the email address (sandra_davis@zebra.com).	
	Thank the caller.
End call.	

### UNIT 3. TRUCKS AND CARGOES

1. Most of the cargoes transported from Belarus have European destinations. Look at the map and name the countries. The list of countries and the first letters of their names are given for you.

Austria  
Belarus  
Belgium  
Bulgaria  
Czech Republic  
Denmark  
Estonia  
Finland  
France  
Germany  
Great Britain

Hungary  
Ireland  
Italy  
Latvia  
Lithuania  
Moldova  
Norway  
Poland  
Portugal

Romania  
Russia  
Slovakia  
Spain  
Sweden  
Switzerland  
The Netherlands  
Turkey  
Ukraine

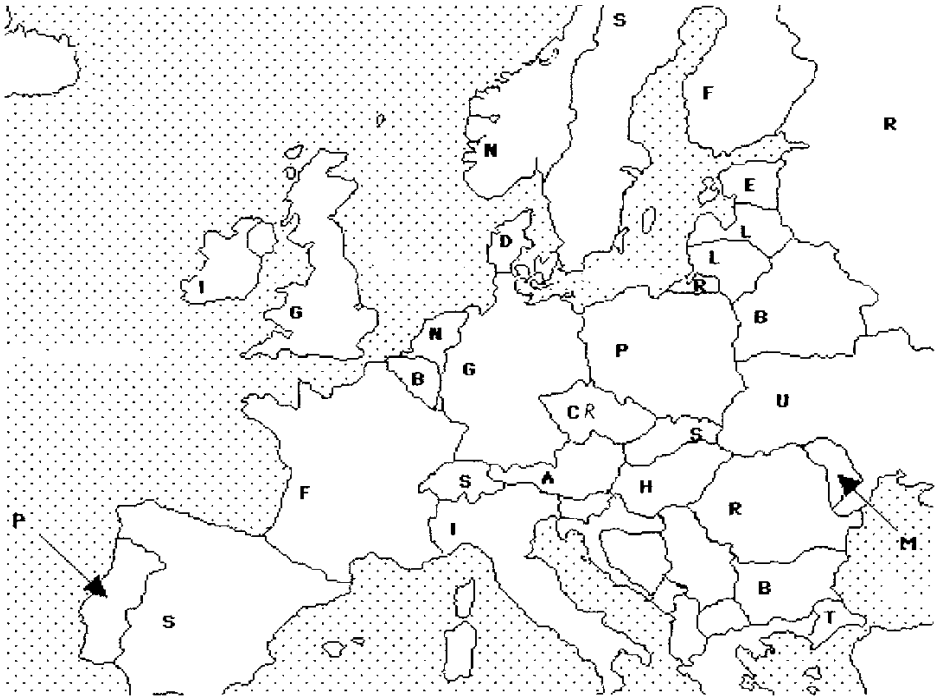

2. Work in pairs. Ask and answer questions about the map of Europe (ex.1). Use the phrases below.

Where's ...?

It's beside/between ...

What are ...'s neighbours?

It's north/south/east/west of ...

3. Identify these European vehicle signs.

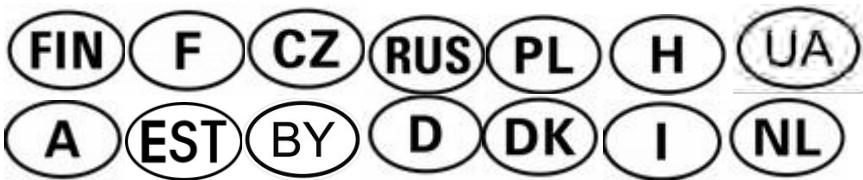

4. Match the words (1-9) with their definitions (a-i) below.

- 1) *semitrailers* 2) *garment* 3) *cargo* 4) *perishable* 5) *pallets* 6) *crate*  
7) *option* 8) *tarpaulin* 9) *mega/jumbo*

- a) something that you can choose to do in preference to one or more alternatives
- b) goods carried on a ship, aircraft, or motor vehicle
- c) portable platforms on which goods can be stacked, stored, and moved
- d) a fabric made of canvas or similar material coated with some water-proof substance
- e) great in size, very large
- f) a wooden case used for transporting goods
- g) a type of trailers having wheels at the back but supported at the front by a towing vehicle
- h) an item of clothing
- i) (especially of food) likely to decay or go bad quickly

5. Complete the sentences with the words (1-9) from ex.4.

- 1) Operators of large trucks and \_\_\_ protect the load in transit with a \_\_\_.
- 2) For larger volumes I would recommend a \_\_\_ truck.

- 3) Because they're not \_\_\_ they're transported by land rather than air.
- 4) What would be the fastest \_\_\_ to transport this kind of \_\_\_?
- 5) The warehouse can hold more than 90,000 wooden \_\_\_.
- 6) When getting out of a vehicle on any dual carriage way or non-urban road, a high visibility \_\_\_ must be worn.
- 7) Could you bring me a \_\_\_ of apples?

6. Study the following notes and discuss them with your partner.

✓ Making enquiries

When asking for information we always use polite language. We often start with a more general request for information before we ask more specific questions. Indirect questions such as *Could you tell me how long it would take?* are more polite than direct questions e.g. *How long would it take?*

*I'd like to ask/enquire about ... /I need some information regarding ...*

✓ Advising the customer

Customers may need advice on transport options, freight and insurance rates, shipping and packing details, the route, details regarding weight, dimensions, and measurements.

*For this consignment I would recommend/suggest using air transport.*

*You should also consider air transport for ...*

*That depends on your specific requirements.*

✓ Offering alternatives

Sometimes you need to provide the customer with several alternatives before a decision can be made.

*Another option would be to ...*

*Of course it would be possible to ... (instead).*

*Alternatively, you/we could ...*

7. Read the telephone conversation between an employee of a transportation company and a customer. Which underlined phrases can you use:

- a) *to make enquiries*
- b) *to advise the customer*
- c) *to offer alternatives*

- Dacoma Car LTD., George Cheluchesku. How can I help you?
  - Hello, this is Emilie Smith from VINO Ltd. **I'm calling about** the truck options described **on your website**. **Could you tell me a bit more about them?**
  - Yes, of course. What exactly would you like to know?
  - We have some new customers in Lithuania and will need to ship **children's goods to Vilnius next month**. **What would be the best truck option for us?**
  - That depends. **For small volumes, I would recommend using** tarpaulin semitrailer trucks. Due to the tarpaulin, goods can be loaded on side of trucks as well as on top. These trucks can load 20-25 tons of goods and their volume is 60-92m<sup>3</sup>.
- |  |
|--|
| articulated lorry (BrE)<br>trailer truck (AmE) |
|--|
- I see. And what about larger volumes?
  - **If you want to ship** larger quantities, MEGA or JUMBO semitrailer trucks **would be more suitable**. These kinds of semitrailers can load 20 tons with the volume of 95-125 cubic meters due to the bigger height of the semitrailer. **As an alternative, I can offer you** trailer trucks. They are usually equipped with removable tarpaulin to facilitate loading of goods.
  - Sounds good. What would be the best option for transport of textiles and garments?
  - **I think the best option would be** trucks or semitrailers with rigid walls. They are usually used to transport goods sensible to weather condition. **Of course, it would also be possible to use them** for transport of any kind of general cargo, either palletized or in crates, bags and boxes.
  - OK. Just one last question: **what would be the safest option** for baby food transport?
  - **For this consignment I'd suggest using** a refrigerated truck where a specified temperature is maintained. But it would be 9% more expensive.
  - I see. How early would we need to place our order?
  - You can place your order up to 24 hours before the actual shipping date.
  - Good. Thank you very much for **your help**. **I'll get back to you as soon as I have our customers' specific transport requirements.**
  - Fine. I look forward to hearing from you again. Goodbye.
  - Goodbye.

8. Complete the table below using the information from ex. 7. You can see some information about other types of trucks.

<i>Vehicle</i>	<i>Description</i>	<i>Cargo</i>
low loader	a lorry with a low floor and no sides	heavy machinery and other outside goods
tank truck/tanker	heat-insulated tank or tank with refrigerating equipment	liquids
dump-body truck	the front of a cargo bed can be lifted to allow its contents to be dumped	sand and other loose material

9. Put the words into two columns: perishable and non-perishable cargoes.

fruits • books • dairy products • cement • cloth • flowers • juice • steel pipes • medicine • canned food • seafood • dry food • frozen food • alcohol • gravel • timber • vegetables • plastic drainage pipes • oil

- ✓ Decide which trucks you would recommend for their transport.  
*e.g. You can use a refrigerated truck to transport ...*  
*A refrigerated truck can be used to transport ... or ...*

10. Match up the sentence halves to make phrases for ex.11.

- |  |  |
|--|--|
| <p>1) Could you tell me how many pallets</p> <p>2) In that case I suggest using</p> <p>3) I need some information</p> <p>4) If you prefer flexibility</p> <p>5) Of course it would also be possible</p> <p>6) We can provide transport by</p> <p>7) You can order up to two days</p> | <p>a) courier if you like.</p> <p>b) we can also arrange transport by road.</p> <p>c) the semitrailer would hold?</p> <p>d) before the loading.</p> <p>e) the cheaper sea option.</p> <p>f) regarding truck options.</p> <p>g) to ship by express service.</p> |
|--|--|



11. Complete these extracts from a telephone conversation with phrases from ex.10.

- 1) - Could you let me know how early we need to place our order?  
- .....
- 2) - .....  
- About 32 europallets.
- 3) - It would be too long. I need it urgently.  
- .....
- 4) - What would be the most convenient way?  
- .....
- 5) - Yes, it would be the cheapest of all the transport options. But it **wouldn't be very flexible.**  
- .....
- 6) - .....  
- Could you tell me how much it would cost?
- 7) - .....  
- What exactly would you like to know?

12. Use the following flow chart to make a telephone conversation.

<i>A customer</i>	<i>An employee from a transportation company</i>
	"STA Logistics. ... speaking."
Introduce yourself. Enquire about truck options.	
	Ask to be more specific.
Give some details of your shipment (destination, time, cargo).	
	Recommend one option.
Tell that you are not sure you want this option.	
	Offer another alternative.
Ask about order deadlines.	
	Answer the question.
Thank for help.	
	End call.

## UNIT 4. ASKING FOR A SHIPPING QUOTATION

1. When talking about cargo details we have to mention some measurement units. Check if you know them. Match the abbreviations below with their meanings (1-13).

in	kg	gal	lb	ft	F	oz	t	l	C	m <sup>3</sup>	cm	cu ft
----	----	-----	----	----	---	----	---	---	---	----------------	----	-------

- |                     |                    |                      |
|---------------------|--------------------|----------------------|
| 1) ounce (=28.3g)   | 6) Celcius         | 11) pound (= 453.6g) |
| 2) gallon (= 3.78l) | 7) centimetre      | 12) cubic foot       |
| 3) ton/tonne        | 8) kilogram        | 13) litre            |
| 4) Fahrenheit       | 9) inch (= 2.54cm) |                      |
| 5) foot (30.48cm)   | 10) cubic metre    |                      |

2. Complete the table with measurement units from ex. 1. Remember only three countries in the world (*the United States, Burma and Liberia*) **don't use the metric system for official measurement.**

	<i>metric</i>	<i>non-metric</i>
length		
weight		
liquid volume		
volume		
temperature		

3. Study the following notes and discuss them with your partner.

When arranging transport, we need to give details about the size and weight of the consignment to be shipped.

✓ Size

*Our consignment is 3 by 2 by 2.5 metres.*

*This box measures 2 by 1.5 by 2.5 metres.*

*Its measurements are 20 by 85 by 60 centimetres.*

metre (BrE)
meter (AmE)

✓ Weight

*The empty container weighs 5,000 kg.*

*The net/tare/gross weight of the container is ... kg/tons.*

*The container's maximum payload is ...*

✓ Dimensions

*The box is 40 cm high/long/wide/deep.*

*Its/The height/length/width/depth is 40 cm.*

Remember:

*This container is almost six metres/feet long (not six metre/foot).*

But: ***It's a twenty-foot container (not feet).***

4. Read the following sentences.

- 1) The regulations limit the maximum size of a semi-trailer to 102 in in width, 13.5 ft in height, and a gross weight of 80,000 lb.
- 2) The units should be picked up on August 6<sup>th</sup>.
- 3) An empty crate weighs 14 lb 14 oz.
- 4) Temperatures **must remain colder than 0°C (+32°F)**, but not fall below **-1.7°C (+28.9°F)**, or the quality of the fresh meat could degrade during the transportation.
- 5) They can carry from 1,600 to 4,100 cu ft of dry or wet cargo.
- 6) The box we need to ship is 1 m long, 50 cm wide and 35 cm high.

5. Match the beginnings (1-7) with the endings (a-g) to make questions for the dialogue from ex. 6.

- |                                  |   |
|----------------------------------|---|
| 1) Could you briefly describe    | a) do you want to ship?                     |
| 2) When would you like the units | b) <b>the goods you want to ship?</b>       |
| 3) <b>Could you give me</b>      | c) other special requirements?              |
| 4) How many tons                 | d) to be collected at <b>your</b> premises? |
| 5) When should                   | e) to ship the goods from?                  |
| 6) Where do you want             | f) <b>delivery be made?</b>                 |
| 7) Do you have any               | g) <b>your telephone number, please?</b>    |

6. Complete the dialogue with questions from ex. 5. Here is a conversation between a forwarder and a customer asking for a shipping quotation.

- STA Logistics, Helen speaking. How **can** I help you?

- Hello, this is Mustafa Sandal from Balnak Ltd., Turkey. I've been trying to complete the online quotation form, but it keeps crashing.
- Sorry about that. We have had some problems with it recently. You said **your name was Sandal, didn't you?**
- Yes, that's right.
- **OK, here it is. Well, it's saved some of your details. We can go through the rest of the consignment details over the phone and I'll fill in the quotation for you.**
- Thanks, go ahead.
- **OK. Um ... Let's start with the cargo details. (.....)**
- **They're toothbrushes and toothpaste and they're going to Minsk, Belarus.**
- **OK, so that's non-hazardous material. (.....)**
- Twenty tons, thirty-three pallets. The volume would be 60 m<sup>3</sup> for the whole consignment.
- (.....)
- Gebse, Turkey.
- **And (.....)**
- On the 24<sup>th</sup> of June.
- **OK, got that. (.....)**
- **It's very important that our customer receives the units on June 30. Would that be a problem?**
- **I don't think so, but I'll check. (.....)**
- No, just that delivery date. And the freight term is DDP Minsk.
- **OK. (.....)**
- **Yes, of course. My number is 02 626 482 001 and my name is Mustafa Sandal.**
- **Thanks very much Mr Sandal. I'll speak to you soon. Goodbye.**

7. Find phrases in the dialogue (ex. 5, 6) which mean the same as the phrases below.

- 1) Could you tell me the date you want to load the goods?
- 2) What is the weight of your cargo?
- 3) Speak to you later.
- 4) What sort of goods do you need to transport?
- 5) What is the country and city of loading?

8. Complete the quotation form in your exercise book with information from ex.6.

Contact information

Company name

Contact person

Your contact information  
(tel, fax, e-mail)

Cargo details

Type and nature of goods

Weight (kg)

Volume (m<sup>3</sup>)

Shipping details

Point of origin

Pick-up date

Destination

Delivery date

Special requirements

Freight terms

Hazardous

Others

9. Make the sentences less direct, as in the example.

✓ Use the past tense (*was, wanted*) instead of the present tense (*is, want*) to be less direct and more polite.

*What was your question?/ I just wanted to check ...*

✓ Use *could* and *would* to make questions or statements less direct.

*Could you tell me what the price would be?*

*What would be your preferred means of payment?*

*e.g. What is your question? What was your question?*

1) How much does it cost? \_\_\_\_\_

2) Do you say 70 or 17? \_\_\_\_\_

3) What is the best option for us? \_\_\_\_\_

4) How long does it take to ship a consignment? \_\_\_\_\_

5) I just want to ask if you can arrange the transport for us. \_\_\_\_\_

6) You say **your name is Davis, don't you?** \_\_\_\_\_

10. Complete these extracts from a telephone conversation with phrases from ex.9.

- 1) - .....  
- For this consignment I would recommend a refrigerated truck.
- 2) - .....  
- **Yes, that's right.**
- 3) -Your company was recommended to us as having very competitive rates. So .....  
- **I'm sure we can help you.**
- 4) - .....  
- There are just a few exact measurements I have to know first before I can quote you a price.
- 5) - .....  
- It would only take 21 hours.
- 6) - My phone number is 20 for Amsterdam, then 2405617.  
- .....

11. Study the following notes and discuss them with your partner.

#### How to structure a message

It's important to structure your message clearly when you speak on an answering machine.

*answerphone = answering machine*

Here is one way to do it.

✓ Say who you are and (if necessary) who you are leaving the message for. *Hello, this is ... calling for ...*

✓ Explain the message step by step. *I'm calling about ... / I just wanted to confirm/check ...*

✓ Say what action you would like the other person to take (if any). *Maybe you could get back to me ... / Could you call me back ... ?*

✓ Make sure the other person knows how to contact you. *Here's my number ... / You can reach me on ...*

Don't forget to keep your message as short as possible and to talk slowly and clearly.

12. Complete the message left on the answering machine with an appropriate phrase *in italics* from ex.11.

\_\_\_ Sam Taylor here. \_\_\_ **your order CJ650. There's a bit of problem, I'm afraid. You ordered 8,450 items, but we can only supply 6,325 from stock. We'll send them today. The other 2,125 will be ready to ship the next day or so, and you should receive them on 10 November. I hope that's okay with you.**  
\_\_\_ **if there's a problem.** \_\_\_ my mobile which is 09976 425749. Bye.

13. Work with a partner. Take turns to be a human answering machine and read out your message for your partner to listen to and take notes. Then compare your notes with the original message.

*Student 1: Hello, Carol. It's George Allen, calling from Donald ASA, Oslo. We have a consignment for you. It's 360 pounds of salmon, vacuum packed, in 12 boxes, to be kept at -6°C. It will be here on April 3 and has to be in Munich by the 6<sup>th</sup> of April at the latest. The total volume will be 2.5 m<sup>3</sup>. Let me know today if you are interested.*

*Student 2: Hi, Joe. This is Jeff Taylor from Prague. Here are the details you asked for concerning the machine that has to be sent to Tallinn. The consignment is in two parts. The first piece weighs 2.5 t and is 8 m long, 1.5 m wide, 0.7 m high. The other one weighs 750 kg and is 2.5 m long, 1.3 m wide, 0.5 m high. Everything will be ready for collection here in Czech Republic on the 25<sup>th</sup> and should be in Tallinn within two weeks.*

14. You are Sam/Sarah Baker, a supplier. Using the information below write a message you are going to leave on an answerphone.

<i>Name:</i>	<i>Sam/Sarah Baker</i>
<i>Company:</i>	<i>Allen NV, Brussels</i>
<i>Problem:</i>	<i>send goods very urgently tomorrow</i>
<i>Destination:</i>	<i>Helsinki</i>
<i>Cargo details:</i>	<i>spare parts, 28 lb, 160x140x75 cm</i>
<i>Phone number:</i>	<i>call back within 1 hour - 02 205 40 00</i>

15. Use the following flow chart and the extracts from ex. 10 to make a complete telephone conversation.

<i>A customer from Division B.V., Amsterdam</i>	<i>An employee from a transportation company</i>
	“Gloria Ltd. ... speaking.”
Introduce yourself. Say you need to ship fresh cut flowers to Minsk, Belarus. Gloria Ltd. was recommended to you. Ask if the company can arrange the transport.	
	Say you ship flowers regularly. Ask about the weight and the volume of the cargo.
<b>You're not sure (about 1000kg and 30m<sup>3</sup>). You need advice on the best option.</b>	
	Recommend a refrigerated truck.
Ask about the transportation time.	
	Say it will be about 21 hours.
Ask about the transportation charge.	
	Say you need the exact measurements.
Say you will find out the exact measurements and ring back in a couple of minutes.	
	Clarify the name of the caller.
Confirm. Give your phone number.	
	Ask for clarification.
Clarify. Thank for help.	
	End call.



16. Use the following flow chart to make a telephone conversation.

<i>A customer</i>	<i>An employee from a transportation company</i>
	“Gloria Ltd. ... speaking.”
Introduce yourself. Say you want to get a shipping quote.	
	Ask to describe the goods.
Say what goods you need to ship and if they are hazardous or non-hazardous.	
	Ask about the measurements.
Say your cargo measurements.	
	Ask about the place of loading and unloading.
Say the names of these places.	
	Ask about the delivery date and freight terms.
Say the delivery date and freight terms.	
	Say you will send a quotation by email. Ask the caller to say his/her email address.
Say your email address.	
	Thank the caller.
End call.	

## UNIT 5. AT THE CUSTOMS

1. Discuss the questions below with a partner.

- ✓ Have you ever gone through a customs inspection at the border?
- ✓ What questions are supposed to be asked by a customs officer at the airport or at the border (country of destination, purpose of visit, anything to declare, any food, fish or meat, how much alcohol, a green card)?

2. Do you agree with the following statements?

	Agree	Disagree
1. Every time you enter any country, you will need to pass through the customs inspection.	<input type="checkbox"/>	<input type="checkbox"/>
2. You are allowed to carry everything to any country.	<input type="checkbox"/>	<input type="checkbox"/>
3. Pets (dogs, cats, etc.) may enter a country only upon presentation of a veterinary certificate.	<input type="checkbox"/>	<input type="checkbox"/>
4. If you do not have anything to be declared, you can come out through the green channel.	<input type="checkbox"/>	<input type="checkbox"/>
<b>5. The red channel is marked with the words “Nothing to declare”.</b>	<input type="checkbox"/>	<input type="checkbox"/>
6. If you are carrying items like electronics, jewelry or other expensive items that attract customs duty you should declare them.	<input type="checkbox"/>	<input type="checkbox"/>
7. Everything that must be declared should be hidden from a customs officer.	<input type="checkbox"/>	<input type="checkbox"/>
8. There is no limit on the amount of cash you can bring into a country.	<input type="checkbox"/>	<input type="checkbox"/>

3. Complete the text using the words from the box.

*controlling • tax • forbidden • checking • shipments • warehouse •  
collecting • immigration*

Customs is an authority or agency in a country responsible for <sup>1</sup> \_\_\_ customs duties and for <sup>2</sup> \_\_\_ the flow of goods in and out of a country. Depending on local legislation and regulations, the import or export of some goods may be restricted or <sup>3</sup> \_\_\_, and the customs agency enforces these rules. The customs authority may be different from the <sup>4</sup> \_\_\_ authority, which monitors persons who leave or enter the country, <sup>5</sup> \_\_\_ for appropriate documentation.

A customs duty is a tariff or <sup>6</sup> \_\_\_ on the export of goods. Commercial goods not yet cleared through customs are held in a customs area, often called a bonded <sup>7</sup> \_\_\_, until processed.

In general customs clearance is a complicated procedure. That's why most importers rely on the services of a customs broker to get their <sup>8</sup> \_\_\_\_\_ cleared at the border.

4. Complete the diagram below. Use all the word combinations with the word **“Customs”** from the text (ex.3). Give the Russian equivalents.

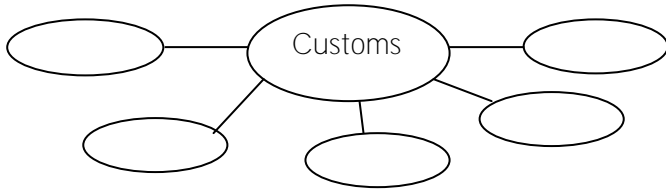

5. To get customs clearance for your cargo you are required to submit some documents to the Customs Authorities. Match the names of documents (1-6) with their definitions (a-f).

- 1) *Packing List* 2) *Insurance Policy* 3) *Export License (if required)*  
4) *CMR note* 5) *Invoice* 6) *Veterinary Certificate (if required)*

- a) a document that lists goods that have been supplied or services that have been done, and says how much money you owe for them
- b) a document for cross-border transport of cargo by road, based on UN recommendations for uniform international rules and in force in the European Union
- c) a document issued by the official veterinarian in the country of origin which provides evidence of specific veterinary or health checks to ensure your products are allowed to import
- d) a document which specifies the contents of any form of packaging, e.g. boxes, containers, cartons, without indicating the value of the goods shipped
- e) a document detailing the terms and conditions of a contract of insurance
- f) a document issued by the appropriate licensing agency after which an exporter is allowed to transport his product in a foreign market

6. Read the conversation between a customs officer and a truck driver at the customs. Using the phrases below (a-h) make improvements to it.

a) *Certainly.*

b) *I'm sorry to hear that.*

c) *Good luck to you!*

d) *Well actually,...*

e) *Could you tell me...*

f) *Oh, no! I'm afraid...*

g) *That would be great.*

h) *... haven't you?*

- Good morning. George Simpson, Customs control. <sup>1</sup> \_\_\_ what cargo you are carrying?

- Feed additives.

- What kind of feed additives?

- Organic acids.

- How are they packed?

- **They're packed in 25 kg multiply bags.**

- Where did you have the cargo loaded?

- <sup>2</sup> \_\_\_ all details of our route as well as the names of the consignor and the consignee are marked in the shipping documents.

- OK. May I see them?

- <sup>3</sup> \_\_\_ Here they are. The CMR note, the Invoice, the Insurance Policy, the Packing List ...

- **You've said you are carrying some kind of feed additives,** <sup>4</sup> \_\_\_

- **That's right.**

- In this case you need to have the Veterinary Certificate for this product. Could you give it to me?

- Just a second... <sup>5</sup> \_\_\_ I have left it at the place of loading.

- <sup>6</sup> \_\_\_ Anyway a set of all documents should be provided with each **consignment. It's one of the required formalities within the customs regulations.** Otherwise the cargo **won't be cleared.**

- I see. Do you need the original?

- Yes, please. Only original documents are considered to be valid while going through the customs clearance.

- Let me contact the consignor for this certificate right now, and no doubt they will send it by DHL immediately.

- <sup>7</sup> \_\_\_ As soon as you get the certificate you will be able to continue the customs clearance. <sup>8</sup> \_\_\_

<p><i>Customs is</i> (the institution) <i>Customs are</i> (the body of procedures, staff, and operations)</p>
---

7. Think of a question for the following answers. Refer to the dialogue (ex.6).

- 1) In Hannover.
- 2) **No, I don't. A copy will be fine.**
- 3) Here it is.
- 4) Machinery equipment.
- 5) Cardboard cartons with polythene inner lining.
- 6) **That's right. There're 20 crates of apples and 15 cartons of bananas.**

8. Which useful phrases can you use:

- a) *to express request (May I see them?)*
- b) *to accept or refuse request (Certainly.)*
- c) *to show annoyance (Oh, no!)*
- d) ***to express regret (I'm sorry to hear that.)***

- 1) **I don't believe it!**
- 2) All right. / Sure.
- 3) **I'm sorry, I can't. / I'm afraid that...**
- 4) Could I ask you to...?
- 5) What a pity!
- 6) **It's unbelievable!**
- 7) **I wonder if you could ...**
- 8) **I'm extremely sorry, but I'm afraid I won't be able to ...**
- 9) Would you mind giving me a couple of minutes?
- 10) Will you (kindly) ... ?
- 11) Why does this always happen!
- 12) Could you give it/them to me, please?
- 13) **I'd like to, but... (give your reason).**
- 14) **Don't worry (about it)!**
- 15) Please, **calm down! We'll think of some way out.**

9. What would you say in these situations? Use the phrases from ex.8. More than one answer is possible.

1) You want the person to show you the Certificate of Origin for the product.....

- 2) You are talking with your friend. He **hasn't submitted the necessary papers and the Customs haven't admitted him**. Express your regret.....
- 3) You will have to leave some bottles of whisky at the customs.....
- 4) You want the person to fill in the declaration form.....
- 5) **You're a customs officer. You want** the driver to place his truck at the bonded warehouse.....
- 6) **You're a driver. You are asked to submit the Export License to the customs but the person responsible for the loading hasn't given it to you**. Refuse the request and give your explanation.....

10. Complete the dialogue and role-play it with your partner.

*Customs Officer:* Good morning! What goods are you carrying?

*Driver:* <sup>1</sup>\_\_\_\_\_.

*Customs Officer:* <sup>2</sup>\_\_\_\_?

*Driver:* Here they are.

*Customs Officer:* <sup>3</sup>\_\_\_\_\_.

*Driver:* **It's unbelievable! I'm afraid that** <sup>4</sup>\_\_\_\_\_.

*Customs Officer:* I see. Do you have any restricted goods or animals?

*Driver:* <sup>5</sup>\_\_\_\_\_.

*Customs Officer:* Do you have a certificate for it?

*Driver:* <sup>6</sup>\_\_\_\_\_.

*Customs Officer:* Thank you. Now you can drive straight on to have your truck weighed.

11. Complete the following table.

	Verb	Noun
1	to calculate	
2		seizure
3	to release	
4	to submit	
5		validation
6	to inspect	
7	to collect	

12. Below you can see the stages of cargo customs clearance procedure. Now complete the phrases with the appropriate noun from the table (ex.11).

- 1) \_\_\_ of a Declaration
- 2) \_\_\_ (goods declaration information is checked for conformity)
- 3) \_\_\_ of customs duty, VAT, environmental levy, etc.
- 4) \_\_\_ of targeted consignments (document inspection, scanner inspection, detector dog, physical/tailgate inspection)
- 5) \_\_\_ of the cargo not conforming to requirements
- 6) \_\_\_ of duties and taxes (payment at the Customs Department, or payment via e-Payment system)
- 7) \_\_\_ of cargo

13. Use the following flow chart to make a complete conversation at the border.

<i>A driver</i>	<i>A customs officer</i>
	"Good afternoon. ..., Customs control." Ask what kind of cargo a driver is carrying.
Say what goods you are carrying.	
	Ask about the type of package.
Say how your cargo is packed.	
	Ask for the shipping documents.
Accept request. Hand the documents to the officer.	
	Look through the documents. <b>You can't see one of them.</b>
Show annoyance. Give the reason.	
	Express regret.
Say you will contact the consignor for this document.	
	Wish luck to the driver.

14. Use the flow chart to make a telephone conversation.

<i>A director of a manufacturing company, Allen Deal Inc.</i>	<i>A customs officer</i>
	“Hello, ... is speaking. How can I help you?”
Say the reason you are calling (your driver has been arrested at the frontier with a consignment of electronic components and printed circuit boards that he was bringing to your factory). Ask about the reason for the delay.	
	Express regret. Explain that the electronic components involved require an export license and <b>the driver doesn't have one.</b>
Express annoyance. Ask about the <b>customs officer's plans</b> concerning your cargo.	
	You want to examine the cargo in detail in the next few days.
Express annoyance. Explain that the delivery is vital for a major contract that is already behind schedule.	
	Express regret. Explain you are very busy at the moment.
Explain if the company does not complete the order on time, the contract will be lost and the company will have to dismiss 100 workers.	
	Explain you cannot discuss the possibility of speeding up the release of the vehicle over the phone.
Try to arrange a face-to-face meeting.	
	Agree.
Thank the officer. End call.	



## UNIT 6. SHIPPING GOODS

1. Discuss the questions below with a partner.
  1. Why do different types of goods come packaged in different ways?
  2. What are the different types of export packing?
  3. What is done to keep moisture from the product?
  4. What kinds of packing are used to protect shipments from damage?
  5. When are these types of export packing used?
  6. How has warehousing changed over the last few years?
  7. What new trends are you seeing in the industry?
2. Read the following text.

One of the main tasks facing any exporter is to make sure that goods reach their buyers and their final consumers in perfect condition. The key is to get your export packaging and labelling right.

There are three main types of packaging that are likely to be needed for exported goods:

- transport or export packaging;
- outer packaging;
- sales packaging.

These three types of packaging work like Russian dolls - each layer of packaging is complete on its own terms, but contained within a further layer of outer packaging.

There is also a huge range of packaging options you can use - from cartons, barrels and drums to wooden pallets, chests and metal containers.

3. Find the expressions in the text (ex.2) which match these definitions:
  1. the outermost layer of packaging and it is designed to protect your goods during transit. Examples include wooden crates, metal drums, chests, bales.
  2. the immediate layer of packaging around your goods - the packaging that remains when the goods reach their end-user. Examples include the

bottles in which beverages are contained, or the boxes many electronics items are sold in.

3. an intermediate layer of packaging, which often also serves a retail-promotion purpose. An example would be a box containing multiple units that doubles as a retail display fixture and can be placed directly on a shop shelf, as is common with many convenience foods.

4. Find the words in ex. 2, 3 to label the pictures.

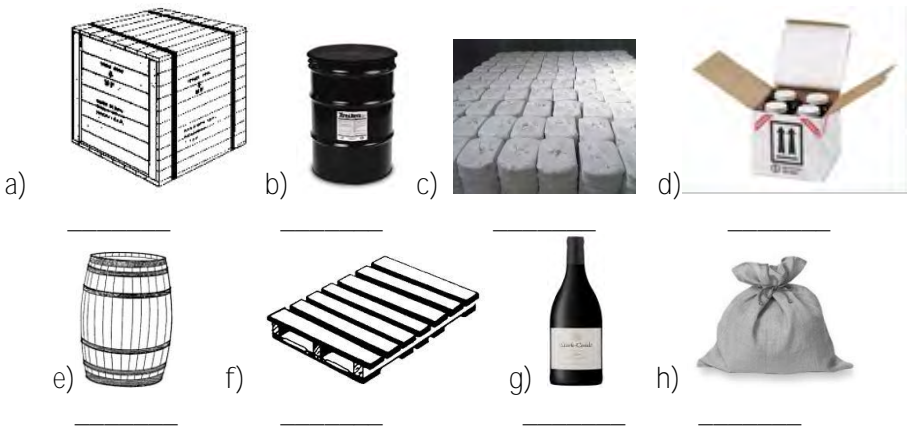

Which of these items does transport/export packaging include?

5. Which of the items (a-h) in ex.4 match with the following definitions?

- 1) a large round container, usually made of wood , with a flat bottom and top and, usually, curved sides. It is used for liquids.
- 2) a large metal container for oil or chemicals, shaped like a cylinder
- 3) a large package of presspacked goods, which is tightly bound, wrapped, and banded
- 4) a large bag made of strong material such as hessian, thick paper, or plastic, used for storing and carrying goods
- 5) a large wooden slatted container for transporting goods

6. Do you know what these markings represent? Discuss with a partner. Try to label the shipping markings with the correct words from the box.

Toxic	•	Store away from heat	•	Fragile	•	Keep dry	•
Explosive	•	This side up	•	Do not stack	•	Use no hooks	

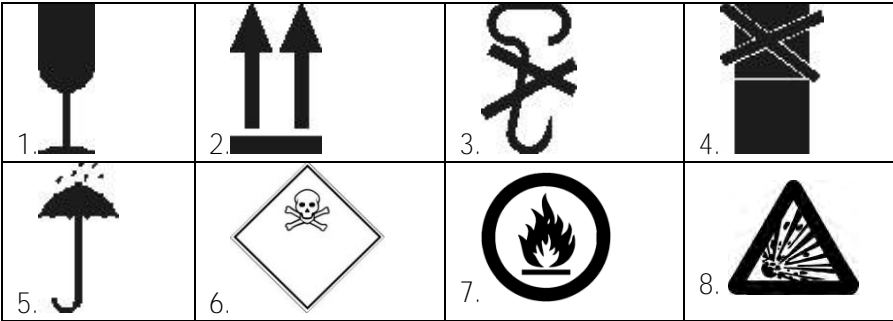

1. Do you know any other markings?
2. Why does each piece of cargo have special shipping markings?
3. What is hazardous cargo? Can you give some examples of potentially hazardous substances/goods?
4. Why must all packages containing hazardous materials be properly marked and labeled?

*cargo transport unit (CTU) means a freight container, swap-body, vehicle, railway wagon (railroad car) or any other similar unit*

7. A CTU should be thoroughly checked before it is packed with **cargo and becomes a “package” for it. The following instructions** may be used to ensure that the CTU is suitable for its job. Choose the correct words to complete these instructions.

1. Check/ choose/ audit that the container serial number, size and type code are the same as those provided by the operator.
2. The walls and roof of a CTU should be in good condition, and not significantly distracted/ distorted/ discharged.

3. The doors of a CTU should work properly and be capable of being soundly/ strongly/ securely locked and seamed/ sealed/ seated in the closed position, and properly secured in the open position.
4. Old labels, placards, marks or signs should be renamed/ removed/ renewed or masked/ messaged/ memorized to prevent delays or misdirection.
5. A CTU should be clean, dry and free of residue/ rest/ reminder and (or) persistent fragrance/ odour / bad breath from previous cargo.
6. A CTU should be free from major damage, with no broken carpeting / tiling/ flooring or protruding/ provocative/ protective nails, bolts, staples etc. which could cause injury to persons or damage to the cargo.
7. Potential points of carriage/ leakage/ haulage/ may be detected by observing if any light enters a closed unit.

8. Match the beginnings of the sentences (1-10) with the endings (a-j).

1. Remove protruding	a. to the trailer using appropriate straps.
2. Couple the trailer to	b. placards, marks and signs from previous use.
3. Detect holes and leaks by	c. are washed off or blacked out.
4. Park the truck	d. the tow vehicle.
5. Reject leaking and	e. distorted containers.
6. Secure the load	f. on a level surface.
7. Distribute the weight of the cargo evenly	g. throughout the trailer.
8. Make sure all old markings and labels	h. observing if any light enters a closed unit.
9. Remove any old	i. loading is complete.
10. Seal the container after	j. staples or nails.

9. Here is an extract from manual providing dump trailer loading instructions. Complete the sentences with words from the box.

*secure • evenly throughout • place • clear • tow vehicle •  
park • overturn • open*

1. Fixed loads that are to be carried should be loaded \_\_\_\_ the trailer.
2. Couple the trailer to the \_\_\_\_.
3. \_\_\_\_ the tow vehicle and trailer on a firm and level surface. Attempting to load on a soft or uneven surface may cause the trailer to \_\_\_\_, which can result in death or serious injury.
4. \_\_\_\_ the area around the trailer.
5. \_\_\_\_ the rear swing gates.
6. \_\_\_\_ ramps of adequate strength at the proper width and load the equipment.
7. \_\_\_\_ the cargo to the trailer using appropriate straps, chains and tensioning devices.

10. International freight forwarders based in New York give some shipping instructions on their website. Complete the sentences with words from the box.

*securely • crates • mark • ship • importing • freight forwarder •  
individually • contractors • clearance*

### Shipping instructions

As the official international <sup>1</sup>\_\_\_\_, we will co-ordinate all international shipments and arrange customs <sup>2</sup>\_\_\_\_ for this event. Please carefully read the following information regarding shipping requirements for <sup>3</sup>\_\_\_\_ goods into the USA.

### Packing and Marking

1. Ensure that all boxes are <sup>4</sup>\_\_\_\_ packed in order to withstand handling by carriers and onsite <sup>5</sup>\_\_\_\_.
2. Clearly <sup>6</sup>\_\_\_\_ all cartons, cases, or <sup>7</sup>\_\_\_\_ on two sides.
3. If you <sup>8</sup>\_\_\_\_ your goods in a container, make sure that all cartons are <sup>9</sup>\_\_\_\_ marked and labeled.

11. Complete this email about an urgent shipment with prepositions from the box.

*by • on • in • with • on • out • on • to • on • between • of • on*

Sonja

I'm afraid there is a problem <sup>1</sup>\_\_ the scheduled deliveries <sup>2</sup>\_\_ France next week. Our customer GLP Pharma in Brest has just informed me that they are already <sup>3</sup>\_\_ of stock and need an urgent delivery of the 5 mg 30 and 90 piece packs this week instead <sup>4</sup>\_\_ next week.

If possible, we must try to make one partial delivery <sup>5</sup>\_\_ Wednesday (or as soon as the packaging is finished) of the 5 mg 30 packs.

We need a direct truck <sup>6</sup>\_\_ our production plant in Germany and Brest. If we can ship the first part <sup>7</sup>\_\_ Wednesday morning, the truck should arrive <sup>8</sup>\_\_ Brest <sup>9</sup>\_\_ Thursday afternoon.

The second delivery should be made <sup>10</sup>\_\_ Friday with the rest of the 5mg 30 and 90 packs. As the products are needed <sup>11</sup>\_\_ Monday, the truck must be unloaded in Brest <sup>12</sup>\_\_ Saturday and Sunday.

Please let me know if there are any problems!

Regards

John Frederikson

Logistics Manager

12. Sonja and John are discussing the urgent delivery over the **phone. Put John's lines (1-6)** into the right place to complete the dialogue.

1. *Bye.*
2. *Can't we use someone that specializes in express deliveries?*
3. *John Frederikson, Export Logistics.*
4. *Hmm. What about the weekend delivery? That's possible, isn't it?*
5. *Hi, Sonja. Thanks for getting back to me so quickly. So what can we do about GLP in France?*
6. *Oh dear. I had no idea this delivery would cause so many problems. I'll talk to GLP again and will get back to you later. Thanks for your help.*

3. *John Frederikson, Export Logistics.*

a. **Hi John, this is Sonja. I'm just phoning about your email.**

□

b. **I think we've really got a problem here. Unfortunately, we can't use one of our regular forwarders for this shipment. I've talked to all of them and the fastest service would take 48 hours.**

□

c. **Not really. I've checked this option too, but I'm not sure it would work for us because they offer a very limited loading capacity. This means that we would have several smaller partial deliveries. And we'd have to pay a lot more as a result.**

□

d. **I'm afraid not. We can't deliver at the weekend because of the HGV driving ban on Saturdays and Sundays.**

□

e. No problem. Speak to you soon. Bye.

13. Answer the questions.

- 1) Can they use one of their usual forwarding agents?
- 2) How long would the fastest delivery service take?
- 3) Would express delivery be a good option?
- 4) Why is it not possible to deliver at the weekend?
- 5) What does John want to do next?

14. Find the phrases in the email (ex.11) and in the dialogue (ex.12) that have the following meanings.

- a. rapid transportation of merchandise
- b. a shipment of only some of the goods that were ordered
- c. not having goods of a specified kind immediately available for sale or use
- d. maximum weight of goods declared permissible by the competent authority of the country of registration of the vehicle
- e. abbreviation for heavy goods vehicle
- f. a person or a company that arranges transportation services for importers and exporters, prepares the appropriate documents, handles insurance matters, etc.

g. the process of bringing goods to a place as agreed before

#### INFORMING SOMEONE ABOUT PROBLEMS

We often use beginnings such as *I'm afraid...* or *I'm sorry, but...*, even if we are not responsible for the problem:

***I'm afraid*** *there is a problem with customs clearance.*

***I'm sorry, but*** *there will a delivery delay.*

We may want to give reasons for the problem:

*The delay was caused by a rail strike in Italy.*

*The consignment has to be repacked because the carton is damaged.*

*There was a delay because the weather was bad/ because of bad weather.*

We may explain that the problem **hasn't** affected the outcome:

***Although the load wasn't secured properly, it arrived intact.***

*In spite of the strike / Despite being delayed, the consignment arrived on time.*

Sometimes we need to explain the consequences of certain events:

***The result was that the goods didn't leave the warehouse until Friday.***

*As a result, the shipment arrived two hours later.*

15. Complete the sentences with words from the box.

*so • because • although • due • as a result • despite •  
because • in spite of*

1. Our customer wants to ship valuable freight, \_\_\_ we need to think about insurance.
2. A part of the shipment seems to be damaged \_\_\_ of rough handling.
3. \_\_\_ the customer needed them urgently, the goods couldn't be delivered at the weekend.
4. The flight was cancelled \_\_\_ bad weather.
5. The driver had the wrong address. \_\_\_, it took him three hours to deliver the pallets.
6. The consignment arrived on time \_\_\_ all the customs formalities at the border.
7. **We are unable to ship today \_\_\_ we've had problems with our dispatch.**
8. \_\_\_ being well secured, the load was damaged on arrival.



16. Choose the correct words to complete these sentences.

1. The documents stated the wrong quantities. As a **reason/result/cause**, the shipment was not accepted at the warehouse.
2. The delay was **found/noticed/caused** by the accident on the motorway.
3. When I spoke to the logistics manager, it **noticed/saw/turned** out that they had used different packing material.
4. **Although/In spite of/But** the delay, the delivery will still arrive on time.
5. What is the **cause/reason/result** for this delay?
6. Unfortunately, we are unable to deliver the consignment **due to/because/so** technical problems in our warehouse.

17. You are a freight forwarder. Call your partner to inform him/her about a delivery delay. Use phrases from the unit.

<i>Student 1</i>	<i>Student 2</i>
1. A consignment of 35 laptop computers has been delivered to <b>the company's branch in</b> Beijing instead of Shanghai. The distribution centre gave you the wrong address. You have just arranged transport to Shanghai. The computers should arrive on Friday.	1. You are the manager of an IT store in Shanghai. You were expecting a delivery of 35 laptop computers. You need the computers to arrive by Friday morning.
2. You are a customer in Canada. You are expecting to have something picked up from your premises tomorrow at 9 am.	2. You have just checked the documents for a shipment to a customer in Canada and noticed that there is something wrong. The pallet height is not the same as in the packing list and the shipping labels are not correct either. You need to <b>wait for correct documents. That's</b> why pick-up time must be changed to 12.30 tomorrow.

18. Read the three phone conversations about a problem with an urgent delivery and put them in the correct order.

1.  2.  3.

A.

*Brit:* Eco-Tech, Brit Egbert speaking.

*Peter:* Hello Ms Egbert. This is Peter Bott from Eco Instal. I understand there is a problem regarding the shipment of relief valves you should have received this morning.

*Brit:* **Yes, well... the containers still haven't arrived. What's the problem?**

*Peter:* **I've just checked all the documents and it seems that we used the wrong address. Your consignment was delivered to another customer by mistake. I'm really sorry about this, Ms Egbert, but I'll do everything I can to get this problem sorted out. If I talk to our forwarders here in the UK now, I'm sure we'll find a solution.**

*Brit:* OK. But make sure that we have the consignment by Monday, **otherwise we'll be in serious trouble.**

*Peter:* **Yes, I understand. I'll get back to you as soon as I've spoken to the forwarder.**

B.

*Simon:* **Hi, Peter. It's Simon here.**

*Peter:* Hi, Simon. How are you doing?

*Simon:* **Fine, thanks. Um, listen, Peter, I've just had a call from our customer in France. They are very upset because that shipment of relief valves, which was supposed to be delivered this morning, hasn't arrived yet. Do you know anything about this?**

*Peter:* **Sorry? I have no idea at the moment, but I'll find out. Do you want me to get in touch with the customer as soon as I know what the problem is?**

*Simon:* Yes, that would be great. The customer says they urgently need the consignment because they want to start packaging on Monday.

*Peter:* **OK, I'll get on to it straight away. Talk to you later then. Bye.**

C.

*Peter:* **Hello, Ms Egbert. This is Peter Bott again. I've just talked to our freight forwarders here in the UK. They'll pick up the containers at the other customer's premises tomorrow morning and get them shipped**

to France by express cargo. That way you should have them by Friday afternoon. Would that be OK for you?

*Brit:* Yes, that sounds good.

*Peter:* **Excellent. There's just one other thing. As I said before, the address on the documents travelling with the containers is wrong. Could you make sure that your logistics people know that? Otherwise the consignment might be rejected at the gate.**

*Brit:* **Yes, I'll see to that. Thanks for your help.**

*Peter:* **It's the least I can do. Let me know if there are any other problems.**

*Brit:* I will. Bye.

19. Answer the questions.

Conversation 1:

- 1) Why is the customer in France upset?
- 2) Why do they need the consignment so urgently?

Conversation 2:

- 3) What went wrong with the shipment?
- 4) When does Ms Egbert say she needs the consignment?

Conversation 3:

- 5) When and how will the containers be shipped to France?
- 6) When should the containers arrive in France?
- 7) Why could the consignment be rejected at the gate?

20. Find phrases in the dialogues which mean the same as the phrases below.

- 1) **How's it going?**
- 2) **I'll call you as soon as...**
- 3) **I'll get on to that.**
- 4) **I'll do everything to solve the problem.**
- 5) **I'll look into the problem.**
- 6) **Do you want me to contact the customer ...?**

21. Complete the sentences with words from the box. Then read the conversations again and check.

<i>get back • the least • very sorry • be OK • just talked • find out • should have • see to • seems that • sorted out • get on</i>
---

- 1) Sorry, I have no idea at the moment, but I'll \_\_\_\_.
- 2) OK, I'll \_\_\_\_ to this straight away.
- 3) I've just checked all the documents and it \_\_\_\_ we used the wrong address.
- 4) I'm \_\_\_\_ about this, Ms Egbert, but I'll do everything I can to get this problem \_\_\_\_.
- 5) I'll \_\_\_\_ to you as soon as I've spoken to the forwarder.
- 6) I've \_\_\_\_ to our freight forwarders here in the UK.
- 7) That way you \_\_\_\_ them by Friday afternoon.
- 8) Would that \_\_\_\_ for you?
- 9) Yes, I'll \_\_\_\_ that.
- 10) It's \_\_\_\_ I can do for you.

### TAKING ACTION AND APOLOGIZING

When responding to a customer, it is good idea to acknowledge that you are aware of the problem.

Note that we tend to use a more formal style in written communication.

*We are replying to your email of April 24<sup>th</sup> **informing us that... (formal)***

*Thank you for informing us about an error in our December statement. (formal)*

*Thanks very much for pointing out the mistake.*

*I understand there is a confusion in addresses/delivery dates.*

We say what we want to do (or have done) to solve the problem. We often use phrasal verbs when talking about taking action:

*We are looking into this matter and will contact you again later today. (more formal)*

***I'll get in touch with the forwarding agent at once.***

***I'll take care of this straight away.***

***I'll get on to that now.***

***I'll see to this immediately.***

***I'll get back to you on that as soon as possible.***

We usually also apologize for the problem or mistake:

*We very much regret this misunderstanding. (more formal)*

***I'm very sorry for that.***

*We would like to apologize for/Let me apologize for this delay/mistake/error/inconvenience.*

22. Complete the sentences with verbs from the box.

*look • take care • see to • get on • get in touch • get back*

1. I'll \_\_\_ to this immediately.
2. Can I \_\_\_ to you in about half an hour?
3. OK, I'll \_\_\_ of that straight away.
4. Fine. I'll \_\_\_ with the courier people at once.
5. Thanks for letting me know. I'll \_\_\_ this right away.
6. Yes, we'll \_\_\_ into the case and call you back tomorrow.

23. Make up a dialogue between Peter and Simon. Use the following flow chart and phrases from the unit.

<i>Peter</i>	<i>Simon</i>
Tell Simon what you have done.	
	Thank Peter for help.
Ask Simon to arrange express transport of the consignment to France through Cargo Worldwide Express, as agreed. Remind him that the goods must <b>arrive at the customer's premises in Rennes, France, on Friday, July 22 by 4 pm at the latest.</b>	
	Tell Peter that you'll take care of all these.
Ask Simon to send the freight invoice to the following address: ECO INSTAL LTD 15 South Road Bournemouth BH8 5SX	
	Ask Peter to email you all the details. Thank Peter for calling.

## UNIT 7. WE ALL GET LOST SOMETIMES

1. Discuss the questions below with a partner.

1. Have you ever got lost while driving somewhere? Are you directionally challenged, or do you have a good sense of direction?
2. Do you use a GPS device, or can you do without it?
3. Are you good at reading maps or following directions?
4. **“With all the tools available to a driver today, asking for directions should be a thing of the past.” Do you agree with the statement?**

2. Read the text.

It's a total cliché that men hate to ask for directions when they're lost. Twenty-six percent of lost male drivers will wait more than a half-hour before asking for directions, while 12 percent refuse to ask at all, according to English car insurance company Sheila's Wheels.

Some men are secure enough in their masculinity to stop and ask for a little help. Thirty percent of male drivers will pull over and ask for directions immediately.

This is good news, because the average man racks up an extra 276 miles in his car each year because he cannot find his way, according to Sheila's Wheels. This adds up to a lot of money in wasted gas.

So guys, your reluctance to ask for directions has you wandering around, wasting time and money. True, many of us have GPS devices now that make life a little easier. But wasn't there something kind of fun about figuring it out the old-fashioned way?

3. Match the phrasal verbs (1-5) from the text (ex.2) with their definitions (a-e).

- |                         |   |
|-------------------------|---|
| 1) <i>figure out</i>    | a) to move about without a fixed course, aim, or goal |
| 2) <i>wander around</i> | b) to move to the side of or off the road             |
| 3) <i>pull over</i>     | c) to become a particular amount                      |
| 4) <i>rack up</i>       | d) to gradually gain a large amount of something      |
| 5) <i>add up to</i>     | e) to understand                                      |

4. Complete the sentences with the phrasal verbs from ex.3.

- 1) **It took them about a month to .....** how to start the equipment.
- 2) His business expenses ..... around **£4,000** a year.
- 3) Last **year**, they ..... **profits of more than \$3 million**.
- 4) **We just .....** **downtown all morning**, looking at the shop windows.
- 5) She saw the ambulance coming **up behind her and .....**

5. Read and comment on the explanations below. Share your own ones for this foolish behavior that many of us engage in.

*Why do men prefer to be lost than ask for directions?*

*"Pride, of course! Men never get lost: they just take a different route," says Phil.*

*"To be honest, asking for directions makes me feel a bit stupid," admits Tom.*

*"We're not going to ask for help from someone who clearly knows more than we do! It's all about protecting the ego," explains Adam.*

*"No guy is going to ask for directions. Short of getting us a GPS, which is only a substitute solution, there's no miraculous remedy," says Phil.*

*"To ask for directions is to admit I am lost. To admit I am lost is to feel both anxious and incompetent... To avoid dealing with this, perhaps it's better to just get a GPS in my car, but then of course I might have to ask directions on how to use that, " explains Mark.*

1) Do you think it's embarrassing to ask for directions? If yes, try to explain why.

2) If you do get lost, do you quickly ask for directions, or do you *soldier on*\* until an *APB*\* is issued by your loved ones?

\*soldier on – *continue to do something although it is difficult or unpleasant*

\*APB (US) abbreviation for *all-points bulletin* – “*сигнал всем постам*”

3) **Instead of driving in circles, getting lost, stressed out, and arriving late, it is more reasonable to plan and prepare your route in advance. Moreover, it is the sustainable thing to do! This will cut unnecessary fuel use and air pollution.”** What do you think about all these? Express your opinions and ideas.

4) The research by Sheilas' Wheels car insurance also found 34 per cent of all drivers would rather ask a woman than a man for directions. Who do you trust when asking for directions?

6. Match the sentences in the box to the pictures below.

<p>1. It's on the corner.</p> <p>2. Go straight on at the lights.</p> <p>3. Take the next right. / Take the next turn on the right.</p> <p>4. Go down to the end of the road</p>	<p>5. It's the second right. / Take the second turn on the right.</p> <p>6. It's on your left.</p> <p>7. It's on the other side of the road.</p> <p>8. Turn left at the traffic lights.</p>
--	---

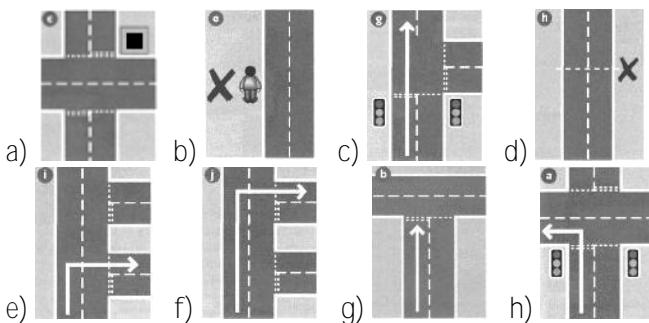



7. How do you get from the station to Church Street? Complete the directions. Use the words in the list.

go • go • take • turn • turn • turn  
Go out of the station, <sup>1</sup> \_\_\_ right, and <sup>2</sup> \_\_\_ down Station Road. <sup>3</sup> \_\_\_ left into Platt Street, then <sup>4</sup> \_\_\_ **the first road on the right**. After the car park, <sup>5</sup> \_\_\_ left, and Church Street is the second on the right.

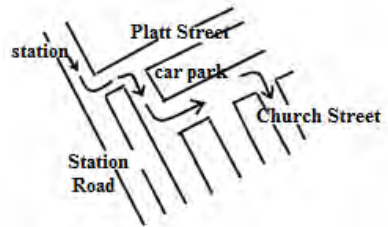

8. Read the dialogue and decide which building (A-X) in our strangely square town is the nearest petrol station to your location.

A: Hello, excuse me, can you tell me how to get to the nearest petrol station?

B: Erm, yea, sure – you go straight up this street. Take the second turn on the right. Keep going along there, across one junction, and it's right there on your left.

A: Thanks.

B: **Oh, no, hang on, wait a minute, there's a closer one.** Walk up this street, take the **first left and there's a petrol station** on your right at the next junction, sorry, I forgot about that one.

A: Thanks again.

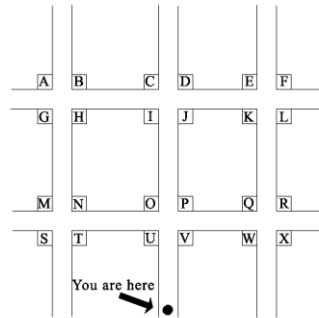

9. Read the conversation in a car. Be ready to answer the following questions.

- 1) Where do they want to go?
- 2) Which road number are they looking for?
- 3) How many times have they passed the supermarket?
- 4) How many people have they asked for directions?
- 5) Have they found the road to Andover?

*Mark:* Rick, do you know where we are?

*Rick:* Yes, of course. Why?

*Mark:* Because we've passed the same supermarket twice.

*Rick:* Oh no.

*Mark:* You'd better stop and ask somebody.

*Rick:* OK.... Excuse me, I'm trying to get to Andover. Do you know how we can get onto the A34 from here?

*Man I:* Yes, first you need to turn round and then take the first turning on the right. Go to the end of the road and you'll come to a roundabout. Take the third exit and you'll come onto the A34.

*Rick:* Great, thanks .... Did he say left or right?

roundabout (BrE) traffic circle (AmE)
--

*Mark:* I can't remember. Look, stop and ask that woman.

*Rick:* Excuse me, we're looking for the road to Andover. Could you tell me which way we need to go?

*Woman:* Andover? Follow the road down and go straight on at the major traffic lights until you come to a petrol station. Then turn left and follow the signs.

*Rick:* OK, thanks.... I haven't seen the petrol station yet.

*Mark:* No, neither have I, but here's that supermarket again.

*Rick:* Oh no.... Excuse me, we're lost. Do you have any idea where the A34 is?

*Man II:* Er, no, sorry.

✓ Complete the phrases.

a) **Do you know how .....** the A34?

b) **Could you tell me which .....**?

c) Do you have any idea **where .....**?

10. Ask the following questions in less direct language using the phrases above (a-c).

1) Where's the nearest bank? - *Excuse me. Do you know where the nearest bank is?*

2) How can I get to the airport from here?

3) I'm looking for the Star Hotel. Which way do I need to go?

4) How can I get to Pine Street from here?

5) Where can I get a taxi?

6) How can I get to the nearest petrol station from here?

11. Work with a partner. Use the information below to do this role-play.

Student A: Ask for directions to a good restaurant/Porsche Centre Minsk/the Plaza Hotel.

Student B: Give Student A directions to the place he/she asks for.

Then ask for directions to the nearest car park/the airport/the nearest McDonald's.

Street Name and Nearby Landmark

*It's on Pine Street.*

*It's on the corner of Fourth and Pine.*

*It's next to the bank.*

*It's across from the school.*

Directions by Car Route

*Take the Westminster turn-off.*

*Go over (Take) the Alex Fraser Bridge.*

*Go through (Take) the Massey Tunnel.*

*It's signposted 'Manchester'.*

***Follow the signs to ...***

*Take the 'A12' to Chelmsford.*

*Go straight on/left/right at the lights/at the roundabout/at the junction of ... **and** ...*

*You'll come to/see ...*

*It's the first turning on the right after the bank.*

*On your left you'll see an industrial centre/a hospital/the police station.*

*Just after the level crossing/shopping centre (or mall).*

*Go past the petrol station/the garage.*

General information in English

***We're not far from...or We're quite close to...***

*It's about a mile/kilometre/two blocks from...*

*We're opposite/next to/in front of/across the road from/round the corner from the supermarket.*

12. Look at the words in bold below. Match each one to the correct diagram.

The road runs up a hill, down a hill, through a tunnel, between some trees, round a bend, under a bridge, over a river, past a small village and along a beach.

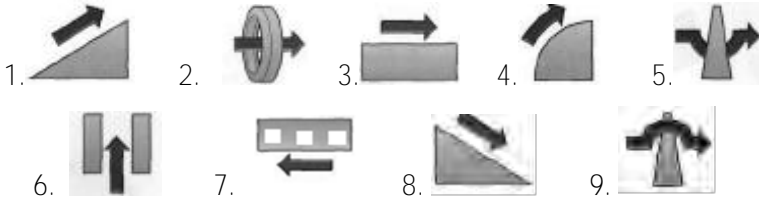

13. Use each word once from ex. 12 to complete these sentences.

- 1) **The earth travels** ..... the sun.
- 2) **Go** ..... the corridor and turn right.
- 3) **You have to fly** ..... the Sonora desert to get to Los Angeles.
- 4) **The shuttle bus runs** ..... factory and the station.
- 5) Some metro trains run on the surface, but most travel ..... ground.
- 6) **Climb in** .... the window.
- 7) Don't go ..... a mountain road any faster than you can go ..... it.
- 8) **They drove back towards Leeds,** ..... the Rixos hotel.

14. Look at the map below and complete these sentences with the following prepositions.

*through • between • round • under • over • past • along*

- 1) The road to Fletchley goes \_\_\_\_\_ the railway line.
- 2) The motorway goes \_\_\_\_\_ the railway line.
- 3) The railway line runs \_\_\_\_\_ two television towers.
- 4) When you drive from Boxted to Redhill, you pass \_\_\_\_\_ Hockley.
- 5) You drive \_\_\_\_\_ a church on your way from Boxted to Hockley.
- 6) The road to Andridge goes \_\_\_\_\_ river
- 7) There are a lot of trees \_\_\_\_\_ Lake Foss.

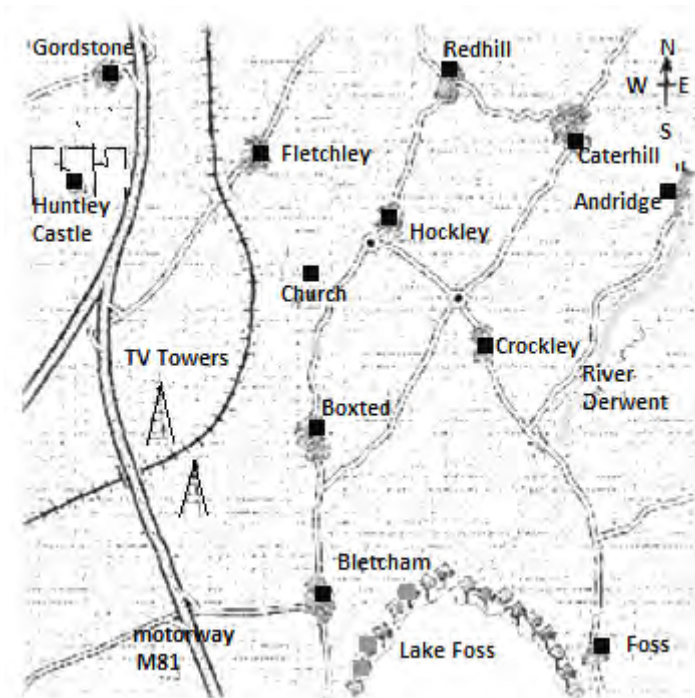

15. Put **B'** (Tom's) lines (a-i) into the right place (1-9) to complete the dialogue.

*B:*

- a) Right. So, how do I get to you from here?
- b) OK. I'll call again if forget that and get lost ...
- c) I'm trying to get to you but I'm lost. My map doesn't show all the roads.
- d) ... the third exit at the roundabout. Is that it?
- e) Yes, left-hand fork and the next exit off the motorway ...
- f) Well, I'm just outside Gordstone ... near the entrance to a motorway - a really new motorway.
- g) George. It's Tom Cruise here.
- h) South, OK.
- i) OK.

A George Thompson.

B <sup>1</sup> .....

A Tom. Where are you?

B <sup>2</sup> .....

A So where exactly are you now?

B <sup>3</sup> .....

A **That's the M81. They've only just built it.**

B <sup>4</sup> .....

A OK. You need to get on the motorway and head south.

B <sup>5</sup> .....

A **Keep going for five miles or so. You'll go past a castle on the right and then the motorway forks just after that. Take the left-hand fork and go over the railway lines. Then get off the motorway at the next exit. Is that clear?**

B <sup>6</sup> .....

A **You'll come to Bletcham. Turn left at the traffic lights in Bletcham and head towards Boxted. But don't go through Boxted. Turn right just before it. The road is signposted to Caterhill.**

B <sup>7</sup> .....

A **Then you'll come to a roundabout. Take the third exit.**

B <sup>8</sup> .....

A Nearly. Take the first road on the left after Crockley. It runs along a river – it's very pretty. **Just drive about a mile and you'll see our factory on the left. We're just after the Pizza Hut. You can't miss it!**

B <sup>9</sup> .....

✓ Draw the route Tom Cruise should take on the map (ex.14).

16. Look at the map in ex.14 and complete these instructions for getting from Foss to Fletchley. Use the words in the list.

*towards • exit • along • miss • off • signposted • after • under • right • past*

Head north <sup>1</sup> towards Crockley. Just <sup>2</sup> \_\_\_ you go through Crockley, **you'll come to a roundabout. Take the first** <sup>3</sup> \_\_\_. **It's** <sup>4</sup> \_\_\_ to Bletcham. Turn <sup>5</sup> \_\_\_ at the traffic lights in Bletcham and join the motorway. Go <sup>6</sup> \_\_\_ **the motorway for about five miles and you'll** <sup>7</sup> \_\_\_ two television towers on the right. Get <sup>8</sup> \_\_\_ the motorway at the next exit. Go through

the tunnel <sup>9</sup> \_\_\_ the railway line and you'll come to Fletchley. You can't  
<sup>10</sup> \_\_\_ it!

17. Match a first part (1-7) with a second part (a-g) to make correct sentences.

- |               |                                      |
|---------------|--------------------------------------|
| 1. Take       | a. lost.                             |
| 2. Head       | b. the third exit at the roundabout. |
| 3. Go over    | c. left at the traffic lights.       |
| 4. Keep       | d. the motorway.                     |
| 5. Turn       | e. going for five miles.             |
| 6. Get on/off | f. north.                            |
| 7. Get        | g. the railway lines.                |

18. Work with a partner. Use the information from the unit to do this role-play.

Student 1 – look at the information below.

Student 2 – look at the information on page 61

### Student 1

**You are at the airport and you need to get to your partner's factory.** Your map is old and out of date. Ask your partner how to get there and draw the route on your map.

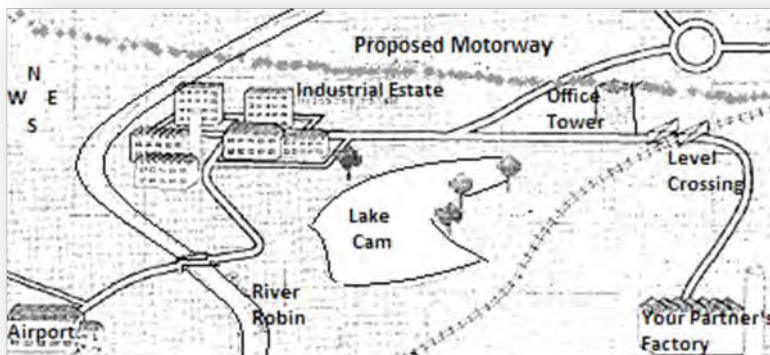

## Student 2

Your partner is at the airport and he/she needs to get to your factory. His/her map is old and out of date. Explain the route so your partner can draw it.

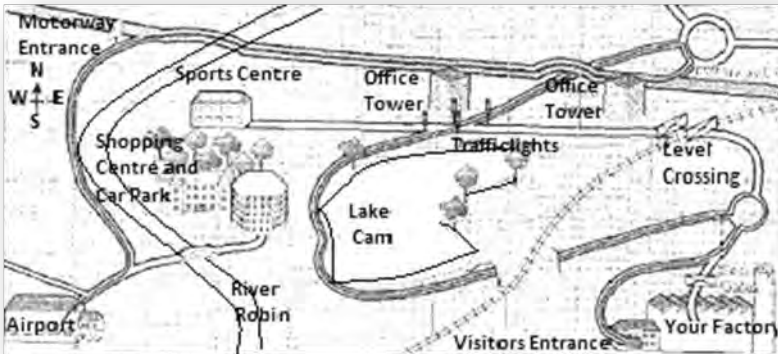

19. Play a game with the group. Make two teams. Each team writes directions from the room you are in now to another place. Take turns to read your directions to the other team. The other team listens and says what place it is.

## UNIT 8. LOGISTICS OCCUPATIONS

1. Discuss the questions below with a partner.

1. What is the difference between “logistics” and “logic”?
2. What eight words do you associate with “logistics”?
3. What different areas of logistics do you know?
4. What logistics jobs do you know?
5. Do you know anything about the logistics industry in our country?
6. Why do you think workers are called “white-collar” and “blue-collar”? In which category is your occupation?



2. Read the article and answer the questions below.

### The logistics industry

The Management of Business Logistics defines logistics: “...*ensuring the availability of the right product, in the right quantity and the right condition, at the right place, at the right time, for the right customer, at the right cost.*” These are also known as the seven Rs.

As the quote above indicates, logistics is the many steps required to move goods or products and related information from the source of raw supply, through the producer or manufacturer, to the final point of delivery, the consumer. These goods and products can be almost anything, including clothing, electronic equipment, food or medical supplies. Logistics is what keeps the shelves stocked in supermarkets, gets your package to your sister in time for her birthday, and ensures your customers receive the goods they ordered. Logistics failures can cause anything from minor inconvenience to major financial losses for a company.

Although it has existed in military operations for hundreds of years, logistics as a business discipline is relatively new. It became part of the modern business world after World War II, with the need to integrate the management of inventory, transportation and warehousing.

Today, logistics is used to manage multi-firm global supply chains, from raw materials to delivery of the finished product to the consumer.

Specifically, logistics involves forecasting and planning, purchasing, procurement, inventory management, stock control, scheduling, distribution, order processing, storage and transportation, freight forwarding and other complex functions. A lot of people are employed in logistics sector occupations, which include everything from truck driver, dispatcher to transportation manager, purchasing and inventory clerks, customs broker to business analyst.

- 1) **The quote at the start of the article mentions “the right condition”** as one of the seven Rs. What does this mean?
- 2) Try to describe a situation where a logistics failure could result in major financial loss for a company.
- 3) Why do you think logistics only emerged as an important business concern after World War II, and not earlier in history?

4) The article names seven logistics professions. What part of the logistics process would these jobs apply to? Can you think of any other logistics professions?

3. There are seven logistics occupations mentioned in the article (ex.2). Match four of them to their duties and responsibilities.

1) \_\_\_\_\_

These workers clear goods through customs and on to their destination on behalf of importer and exporter clients. They may also act as freight forwarders. Main duties include preparing and processing import/export documents, applying correct tariff classifications on import/export goods, paying applicable duties and taxes, arranging for transportation and storage of goods, advising clients on import/export restrictions, tariffs and insurance, and acting as client representatives at meetings with government officials.

2) \_\_\_\_\_

These workers relay orders to coordinate the movement of vehicles and freight. They are responsible for processing and providing information and instructions to field personnel, assigning personnel according to schedules and work orders, advising vehicle operators of problems and dealing with emergency situations, monitoring the location of personnel, and maintaining work records.

3) \_\_\_\_\_

Workers in these occupations maintain inventories of goods and materials. Their main duties include monitoring inventory levels, compiling inventory reports using manual or computerized systems, preparing requisition orders, and maintaining stock rotation.

4) \_\_\_\_\_

Workers in this occupation coordinate and monitor the transportation and movement of goods, arrange for shipping documentation and oversee the scheduling and tracking of goods in transit, negotiate with carriers, control the departmental budget, evaluate freight and inventory costs, and supervise training of new workers.

4. Match each word or phrase (1-5) with its definition (a-e).

- |                      |   |
|----------------------|---|
| 1) field personnel   | a) to supervise                             |
| 2) requisition order | b) staff who work away from the head office |
| 3) to compile        | c) to watch and check                       |
| 4) to monitor        | d) formal written demand for something      |
| 5) to oversee        | e) to collect and put together information  |

5. Complete the sentences below using phrases from the box.

<i>documents • schedules • reports • field personnel • requisition orders</i>
---

- 1) Dispatchers advise and monitor \_\_\_\_\_.
- 2) Customs brokers sign \_\_\_\_\_ on behalf of clients, using powers of attorney.
- 3) Inventory clerks prepare \_\_\_\_\_.
- 4) Transportation managers coordinate \_\_\_\_\_.
- 5) Inventory clerks compile \_\_\_\_\_.

✓ Add four more half-sentences like the ones above, and ask a partner to complete them.

6. Match the definitions (a-f) with the words (1-6).

1) *courier* 2) *consignee* 3) *carrier* 4) *freight forwarder* 5) *supplier*  
6) *haulage contractor/haulier*

- a) person or business that arranges documentation and travel facilities for companies dispatching goods to customers
- b) company which carries goods by road
- c) company which supplies parts or services to another company; also called vendor
- d) person or firm named in a freight contract to whom goods have been shipped or turned over for care
- e) company that transports or conveys goods
- f) company that specializes in the speedy and secured delivery of small goods and packages

7. Three people are describing their jobs in logistics. Choose three of the jobs below to match to the correct persons.

*warehouse manager*  
*forklift driver*

*freight forwarder*  
*shipping operations manager*

Person 1 is a \_\_\_\_\_

My job is to organize the transport of goods either by sea, air, road, or rail. An important part of the job is dealing with customer requests about the most suitable mode of transport. My responsibilities also include negotiating good shipping rates with shipping lines and transport companies.

I also make booking reservations that means I book space on a ship, train, lorry, or airplane. Apart from that, I have to deal with all the necessary documentation and, in many cases, I arrange customs clearance on behalf of my clients.

Person 2 is a \_\_\_\_\_

I'm responsible for getting freight and passengers to their destination safely and on schedule. Most of my customers are international transport or shipping companies. In my job I have to make sure that the cargo is not damaged on board the ship or while loading or unloading. I'm also responsible for financial aspects; that means, for example, I have to keep an eye on the budget and estimate costs.

Additionally, I advise customers on shipping rates and prepare quotations for our sales office.

Person 3 is a \_\_\_\_\_

Generally my job is to know where every piece of stock is at any given moment. When new goods arrive, I check where to put them in the warehouse. I use modern computer systems and sophisticated hardware and software. Our warehouse management system helps us store and retrieve the goods quickly. Another part of my job is to liaise with departments such as transport and production. Apart from that, I ensure that vehicles, machines, and any other kind of equipment are maintained to a high level.

8. Match the verbs (1-6) with the activities (a-f) to make phrases from the previous exercise. Then read again to check if necessary.

- |          |  |
|----------|--|
| 1. deal  | a. space on a ship, train, lorry, or plane |
| 2. keep  | b. where to put goods in the warehouse     |
| 3. use   | c. with all the necessary documentation    |
| 4. check | d. modern computer system                  |
| 5. book  | e. an eye on the budget                    |
| 6. make  | f. booking reservations                    |

9. Replace the verbs in bold with words from the box that have the same meaning. Guess what jobs these people do?

*ensure • organize • advise on • supervise • check*

1. I inform clients about import/export restrictions, tariffs and insurance.
2. Workers in this occupation oversee the scheduling and tracking of goods in transit.
3. I have to make **sure** that the cargo is not damaged onboard the ship or while loading or unloading.
4. I also plan the transport of goods.
5. In my job I have to monitor inventory levels.

10. Match the following logistics occupations to the tasks (1-18) listed below. Classify these tasks according to the skills (N-T) needed to perform them.

*customs brokers*  
*purchasing clerks*  
*inventory clerks*  
*dispatchers*

*shipping operations manager*  
*freight forwarder*  
*warehouse manager*

N – numeracy skills R – reading comprehension P – physical skills	W – writing skills C – communication skills T – thinking skills
---	---

1. Represent clients in dealings with government officials.\_\_\_\_
2. Determine job priority, taking into consideration factors like weather, safety, and urgency.\_\_\_\_
3. Interact with customers to clarify procedures and answer questions.\_\_\_\_
4. Evaluate freight costs and inventory costs associated with transit times.\_\_\_\_
5. Lifting boxes, packages and cartons.\_\_\_\_
6. Prepare import/export documents and sign them on behalf of clients.\_\_\_\_
7. Schedule when and how much inventory should be available based on past amounts used and projected demand.\_\_\_\_
8. Climb ladders to store or inspect stock on top shelves.\_\_\_\_
9. Refer to Material Safety Data Sheets to learn whether incoming goods are hazardous and how they should be handled.\_\_\_\_
10. Spatial perception for visualizing space in which goods will be unloaded.\_\_\_\_
11. Discuss problems, work progress and how to complete jobs with supervisors.\_\_\_\_
12. Calculate how many trucks are needed for a given amount of goods.\_\_\_\_
13. Get information from directories, maps and manuals regarding routing, scheduling and regulations.\_\_\_\_
14. Keep daily logs of what is received and sent out, including reference numbers, type of product and billing instructions.\_\_\_\_
15. Keep up-to-date on trade and customs procedures, laws and regulations.\_\_\_\_
16. Prepare incident reports and maintain records.\_\_\_\_
17. Quote duty and tax rates on goods and arrange for payment.\_\_\_\_
18. Remember schedules, code numbers and measurements.\_\_\_\_

11. Match the occupations mentioned in ex.10 with the verbs (a-t) below to make sentences describing everyday tasks for different logistics occupations.

Example: *A dispatcher uses a headset to liaise with drivers.*

*Dispatchers liaise with warehouse workers.*

- |                |              |              |
|----------------|--------------|--------------|
| a) plan        | h) monitor   | o) check     |
| b) schedule    | i) negotiate | p) use       |
| c) calculate   | j) maintain  | q) deal with |
| d) consult     | k) estimate  | r) make sure |
| e) liaise with | l) contact   | s) book      |
| f) assign      | m) quote     | t) process   |
| g) prepare     | n) relay     |              |

### Vocabulary

Full-time means 40 hours a week and a regular schedule. For example, Monday to Friday, 9 to 5.

Part-time means working only a few hours a week. For example, less than 25 hours a week, maybe Monday, Tuesday and Wednesday, 10 to 3.

Casual part-time means that work is not steady. Sometimes it may be 10 hours a week, and sometimes 20. It depends on how much work there is.

Contract work means that you are hired to do a job or a project. When the job or project is finished, so is your employment.

Shift work is a set number of hours in a day. For example, the day shift is usually from 8 am to 4 pm; the afternoon shift is from 4 pm to midnight; and the night shift is from midnight to 8 am.

Salary is a fixed, regular payment to employees. This could be a monthly, weekly or bi-weekly payment.

Wage is the regular payments received for work or services, usually given as an hourly amount.

Benefits are paid for by employers for things like sick pay and parental leave.

12. Fill each space with a suitable word from the box.

1) Customs brokers

*full-time • shifts • part-time • physically demanding • service • shipments • independently • hours*

Workers at border crossings often work <sup>1</sup>\_\_\_ to provide 24-hour <sup>2</sup>\_\_\_ to clients. Brokers in other locations usually work regular <sup>3</sup>\_\_\_ during the week, although they may have to come in on weekends or in the evening

to meet scheduled <sup>4</sup> \_\_\_\_\_. Customs brokers may work <sup>5</sup> \_\_\_\_\_ or <sup>6</sup> \_\_\_\_\_, depending on the company. Brokers may work <sup>7</sup> \_\_\_\_\_ or as part of a team. The work is not <sup>8</sup> \_\_\_\_\_, but it can be stressful.

## 2) Dispatchers

*rotating • equipment • conditions • equipment • centres • shifts • offices • schedule*

Working <sup>1</sup> \_\_\_\_\_ for this occupation vary according to the employer. Some dispatchers work in small <sup>2</sup> \_\_\_\_\_ with simple <sup>3</sup> \_\_\_\_\_, while others work in large call <sup>4</sup> \_\_\_\_\_ with complex, computerized <sup>5</sup> \_\_\_\_\_. Dispatchers work in <sup>6</sup> \_\_\_\_\_. If service runs 24 hours per day, staff may work <sup>7</sup> \_\_\_\_\_ shifts. Nights, holidays and weekends are part of the <sup>8</sup> \_\_\_\_\_.

## 3) Transportation managers

*warehouses • overtime • travelling • networks • shift • regular • 24-hour • environment*

They usually work in an office <sup>1</sup> \_\_\_\_\_. Most work <sup>2</sup> \_\_\_\_\_ hours during the week, but in large organizations <sup>3</sup> \_\_\_\_\_ work may be required to cover <sup>4</sup> \_\_\_\_\_ service. <sup>5</sup> \_\_\_\_\_ is not unusual. Depending on the size and nature of the company, some <sup>6</sup> \_\_\_\_\_ may be necessary to evaluate locations for new <sup>7</sup> \_\_\_\_\_ or distribution <sup>8</sup> \_\_\_\_\_.

## 4) Inventory clerks

*platforms • working • warehouses • stock rooms • hours • weekend • inventory • shipments*

<sup>1</sup> \_\_\_\_\_ conditions in these occupations vary by employer. Clerks usually work in offices, but may also work in <sup>2</sup> \_\_\_\_\_ or <sup>3</sup> \_\_\_\_\_ that are not always climate-controlled. Work on loading <sup>4</sup> \_\_\_\_\_ exposes workers to all kinds of weather. They typically work regular <sup>5</sup> \_\_\_\_\_ during the week, but evening and <sup>6</sup> \_\_\_\_\_ hours may be standard in some jobs, and may be required in others when large <sup>7</sup> \_\_\_\_\_ are due or <sup>8</sup> \_\_\_\_\_ needs to be taken.

13. Fill each gap in the following sentences with a suitable word or phrase. The first letter of each word is given.

1. When a job requires uncomfortable positions or a lot of effort or movement we say the job is p\_\_\_\_ d\_\_\_\_\_.



2. If you usually stop work at 5 pm but have to stay until 7 pm one day to finish a job, we say you are working o\_\_\_.
3. An example of s\_\_\_ w\_\_\_ is a workday that runs from 4 pm to midnight.
4. A building that has central heating and/or air conditioning is c\_\_\_ c\_\_\_.
5. A s\_\_\_ job is mentally demanding, where work is performed under pressure.
6. If you work a r\_\_\_ shift, your working hours will change on a regular basis.

14. Read these ads for logistics positions and answer the questions with a partner.

<p>1. TRANSPORTATION DISPATCHER</p> <p>The Transportation Group is a leading provider of Transportation and Supply Chain services to customers in North America. We are looking for an individual to serve as the liaison between our client base and the transport industry. The successful candidate will have two – five years dispatch experience, strong customer service and administrative skills, proven written and verbal communication skills, and the ability to work in a Total Quality environment that stresses teamwork. Computer literacy is required. Previous experience in third party logistics transportation would be an asset.</p> <p>CANDIDATE MUST POSSESS:</p> <ul style="list-style-type: none"> <li>• <b>Above average communication skills</b></li> <li>• <b>Geographic knowledge of the country</b></li> <li>• <b>Customs knowledge</b></li> <li>• <b>Knowledge of load planning in either an LTL or TL environment</b></li> <li>• <b>Above average computer skills</b></li> </ul> <p>Education requirements: High School; Post Secondary an asset.</p> <p>This is a full-time, permanent position working the afternoon shift.</p> <p>Forward resumes in confidence to Kathy Lee, Operations Manager at klee@abc.com.</p>
<p>2. LOGISTICS COORDINATOR</p> <p>KL Logistics is one of the largest and fastest growing third party transportation logistics providers in France. We offer our clients customized solutions, business growth, peace of mind, and simplicity in</p>

addressing all their transportation logistics needs.

Job Description:

A logistics coordinator is responsible for formulating and delivering the optimal logistical solutions for our clients by organizing the movement of freight in the most cost-effective and reliable manner possible. Other responsibilities include:

- **Finding optimal transportation routes for our clients.**
- **Negotiating rates with carriers.**
- **Problem-solving** client specific issues and ensuring the highest level of customer service.
- **Researching and finding new carriers.**

Job Requirements:

This is an ideal position for a results-oriented, self-motivated individual. Excellent communication and negotiation skills are required, coupled with effective problem-solving and organizational skills. You are also a hi-energy team player with great interpersonal skills looking for career advancement. Experience in the transportation industry would be a definite asset.

This is an entry-level  , **fulltime** position.

Entry-level qualifications *are the minimum requirements for workers with no previous experience in the logistics industry*

- 1) Do any of these jobs interest you? Why or why not? Do you have all the necessary qualifications?
- 2) Are all these jobs permanent positions?
- 3) **Ad 1 requires “the ability to work in a Total Quality environment”.** What is this? Try to explain.
- 4) **Ad 1 uses the term “liaison“.** What does this mean?
- 5) **Ad 2 requires “great interpersonal skills”.** What do you think this means? Why are these skills important in this job?
- 6) Are there any similarities in working conditions or requirements between these two jobs?
- 7) **What are LTL and T/L? If you don’t know, try to find out.**
- 8) Work with your partner to formulate some questions you would ask the employers who posted these ads.

Talking about job responsibilities	
<u>Questions</u> <i>What do you do?</i> <b><i>What's your line of work? / What does your job involve?</i></b>	
<u>Describing jobs</u> <i>I work for a major shipping company.</i> <i>I work in the regional depot.</i> <i>You work in an area or a department.</i>	
<u>Describing responsibilities</u> <b><i>I'm responsible for... / In my job I have to...</i></b> <b><i>My job involves... / I am in charge of...</i></b>	
Personal qualities	
<i>adaptable</i> <i>ambitious</i> <i>calm under pressure</i> <i>collaborative</i> <i>competitive</i> <i>confident</i> <i>creative</i> <i>decisive</i> <i>enthusiastic</i> <i>flexible</i> <i>hard-working</i>	<i>organized</i> <i>passionate</i> <i>persistent</i> <i>proactive</i> <i>persuasive</i> <i>precise</i> <i>punctual</i> <i>a quick learner</i> <i>reliable</i> <i>tactful</i> <i>tolerant</i>

15. Work with a partner to describe these two different jobs. The **phrases in the box “Talking about job responsibilities” will help you.**

<u>Store Supervisor</u> Job specification for position <ul style="list-style-type: none"> <li>• responsible for store and inventory</li> <li>• make purchase requests for all stocked items that are minimum</li> <li>• receive and process incoming orders</li> <li>• ensure materials received are in</li> </ul>	<u>Freight Forwarder</u> Job specification for position <ul style="list-style-type: none"> <li>• arrange routes and schedules, and confirm the details with carriers</li> <li>• book cargo space with carriers</li> <li>• deal with rates and insurance</li> <li>• calculate weight, volume and cost of goods to be moved</li> <li>• prepare quotations and invoices</li> </ul>
---	--

good condition

• clear goods through customs

You can follow the steps below to practice the dialogue.

<i>Partner A</i>	<i>Partner B</i>
Ask B what he/she does.	
	Tell A where you work.
Ask B to give you some details about the job.	
	Tell A about your main job activities. Then ask A about his/her job.
Describe your job activities.	
	Ask A what personal qualities are most important for his/her job.
Tell B what personal qualities you think are most important in your job. Ask B whether these same qualities <b>are important in B's job.</b>	
	Answer in the affirmative or negative. Then tell A about the most important qualities for your job.
Ask B whether he/she enjoys his/her job and why (or why not).	
	Try to explain why you like or dislike your job.

16. Find a logistics sector company that operates in your area. Do they have a Web site? If so, visit the Web site.

- 1) Look at the company's organizational chart. Which department would your profession most likely fall under?
- 2) Describe the company. Does it sound like a good place to work?

3) If the company has a career centre on-line, look at the job postings. Are any of them in your area of expertise? Do you have the necessary qualifications?

## Vocabulary

admit to the country - разрешить въезд

annoyance - досада, раздражение

attorney - адвокат, юрист, поверенный

bale - кипа (товара); тюк

bonded warehouse - таможенный склад для хранения нерастаможенных товаров (не оплаченных пошлиной)

casual - случайный, временный, нерегулярный

consignment - 1) коносамент, транспортная накладная 2) партия груза, груз

convenience foods - консервированные, быстрозамороженные продукты и полуфабрикаты

couple - n. пара; v. соединять; сцеплять

cargo bed - грузовая платформа

crate - 1) решётчатая тара, ящик; 2) крейт, контейнер с ячейками

customs - 1) таможенные пошлины 2) таможня, таможенный пост

customs authority - таможенная администрация

customs broker - агент по таможенной очистке импортных грузов

customs clearance - очистка от таможенных пошлин

customs seal - таможенная печать, таможенная пломба

DHL mail - экспресс-почта

display fixture (equipment) - экспозиционное оборудование

dump - выгружать, разгружать, сваливать

dump (body) truck - самосвал

enforce - *юр.* придавать законную силу (правовому акту), осуществлять, приводить в исполнение

field personnel - специалисты по эксплуатации; персонал, работающий вне офиса

garments - одежда

handling - обработка грузов (погрузочно-разгрузочные работы, сортировка, упаковка, маркировка и прочие подобные работы)

haulier - автотранспортная организация, перевозчик

hazardous cargo - опасный груз

inventory - материально-производственные запасы; инвентаризация;  
**наличные товары**

liaise - (liaise between/with) поддерживать связь

liaison - связь, контакт, регулярный обмен информацией между группами людей, особенно на работе)

loose material - сыпучий материал

LTL - less than truckload – количество груза меньше минимально оплачиваемого по льготному тарифу

payload - полезная нагрузка; оплачиваемый груз, грузоподъемность

perishable - скоропортящийся груз, товар

portable container - переносной контейнер

post-secondary education - высшее образование

procurement - 1) получение, приобретение; закупка 2) поставка, снабжение

~ material procurement - материальное снабжение

protruding - выдающийся, выступающий вперед, торчащий

premises - недвижимость, помещение, здание с прилегающими постройками и участком земли

~ business premises - служебное помещение

~ company premises - площадь, которой владеет компания

purchasing - покупка; закупка; приобретение

quotation - 1) котировка 2) курс 3) расценка 4) цена 5) биржевая цена 6) предложение 7) оферта

ramp - 1) пандус 2) наклонная плоскость 3) "лежащий полицейский" (искусственная неровность для ограничения скорости транспорта)

retail - розничная продажа

restricted goods - ограничиваемые товары (товары, для производства или экспорта/импорта которых требуется специальное разрешение)

scheduling - планирование; распределение; составление графика, расписаний

seize - 1) захватывать 2) налагать арест 3) задерживать

seizure - 1) захват 2) конфискация 3) наложение ареста

strap - 1) лента; ремень; стягивать ремнем 2) скоба; хомут; бугель; строп; скреплять скобой

tailgate - задняя дверь (автофургона), задний откидной борт (авто)

tarpaulin - брезент; покрывать брезентом

Third Party Logistics (3PL) - логистика третьей стороны (3PL) - привлечение внешних ресурсов (аутсорсинг) - означает предоставление комплекса логистических услуг в виде внешнего специализированного агентства для организации логистики компании.

Total Quality environment - среда, в которой реализуется концепция комплексного управления качеством

tow - буксир; буксировать

validity - 1) юридическая сила, действие 2) период действия 3) обоснованность

VAT - value-added tax - налог на добавленную стоимость – НДС

vendor - поставщик, продавец

warehousing - хранение на складе, складирование

white collar - "белый воротничок"; человек, работающий в офисе (служащий, клерк, управляющий); blue collar - "синий воротничок", производственный рабочий

Учебное издание

Боярская Анна Олеговна  
Ладутько Наталия Фёдоровна  
Митьковец Татьяна Евгеньевна

Spoken English for Transportation

Технический редактор  
Компьютерная верстка Н.Ф. Ладутько

---



## **Ситуации для промежуточного и итогового контроля навыков и умений устной речи**

Situation I. *Think over the ways the system of higher education in Great Britain is similar to or different from that in Belarus. Use the plan below:*

- the admission to the universities
- the academic year
- the main teaching and assessment methods
- the degrees provided by the universities
- the facilities and opportunities offered by the universities

Situation II. *Work with a partner and prepare a five-minute presentation about your dream university using the questions below. Give your presentation to the class.*

- 1) Where is the university located?
- 2) What courses does it run?
- 3) How much does the course cost?
- 4) What are the dates of the terms? Are they convenient?
- 5) What is the length of the course?
- 6) Is teaching carried out in small groups (tutorials) or large groups (lectures)?
- 7) How are the students assessed?
- 8) What facilities does the university offer?

Situation III. *Dwell on one of the following statements, 'knowledge is power', 'the roots of education are bitter, but the fruit is sweet', 'The years at the university are the best in your life'.*

Situation IV. *Imagine you are making a website for one of the British universities. Find the information for the following tabs: HOME PAGE, FOR APPLICANTS (accommodation, tuition fees, degree courses, study facilities), CONTACTS.*

Situation V. *Work in groups of four. Imagine that one of you is in charge of the student's exchange programme, the others are a group of students from the University of Leeds. You are to answer their questions and give them the most essential information about the BNTU.*

*Situation VI. Work in groups. Imagine that a group of students from the University of Manchester has arrived in Minsk to take part in the Prospects of Engineering Education Conference. Think over the questions you would like to ask and be ready to answer theirs.*

*Situation VII. Choose a Belarusian manufacturing company. Work with your partner and prepare a five-minute presentation about the company, including the tips below:*

- *company history*
- *company size*
- *products and markets*
- *quality improvement activities*

*You can visit the company website to help you.*

*Give your presentation to the class.*

*Situation VIII. Work in pairs. Your friend has just read the text 'The Industry of Belarus'. Interview him about one of the leading branches of national economy (automotive engineering, tractor and agricultural engineering, radio-electronics, electrical engineering, chemical and petrochemical industry). Ask about:*

- *the leading enterprises in this sector ...*
- *the kinds of products the industry specializes in ...*
- *if the companies produce competitive products ...*
- *where the manufacturing output is exported ...*

Intermediate Lexical-Grammar Test  
(Term 1. "Basic English for Technical Students". Part 1)

I. Put all possible questions to the following statements.

1. She is a physicist.
2. They are second-year students.
3. Water-cooled engines always have a radiator.
4. There is an engine in all motor vehicles.
5. There are two hammers on the workbench.

II. Fill in the gaps with prepositions.

1. **The student is fond ... engineering.**
2. **Tom and Peter are busy ... their coursework.**
3. Oleg is **tired ... doing lab works.**
4. **My group mates are good ... programming.**
5. **Mike is interested ... applied mechanics.**

III. Match the expressions with their synonyms.

1. I am fine	1. vehicle
2. sophomore	2. undergraduate
3. full-time department	3. I am great
4. student	4. second-year student
5. beautiful	5. attractive
6. motor	6. day-time faculty

IV. Choose the correct verb form (*to be* or *to have*)

1. **These objects ... different shapes.**
2. **What shape ... the box?**
3. **... the door square or rectangular?**
4. **... the nails circular?**
5. **I ... very busy today.**
6. **Squares ... four equal sides.**
7. **Triangles ... three sides and three right angles.**

V. Fill in the gaps.

- 1.- **How ... is the box?**  
- It is two centimeters wide.
2. - **How ... is it?**  
- It is three centimeters long.
3. - **By the way how ... is it?**  
- It is two centimeters wide.
4. - **And what is the ... of this box?**  
- It is twelve cubic meters.

VI. Correct mistakes.

1. This road is long than that one.
2. These lamps is circular.
3. How width is the box?

4. The wide of the box is 8 cm.
5. It is the larger box in the workshop.
6. The area of the window is 2 cubic meters.
7. The lorry is high then the bridge.

VII. Put the words in the correct order to make a sentence.

1. Engines/have/modern/almost/all/valves/vehicles.
2. Side/are/these/valve/engines.
3. At/the/side/the/valves/of/the/cylinder/are.
4. Are/not/the/side/engines/very/valve/powerful.
5. Overhead/are/also/these/engines/for/vehicles/valve.
6. The/engine/valves/the/overhead/design/this/in/are.

VIII. Choose the right pronoun.

1. What is (**его**) father?
2. Where are (**ее**) parents?
3. They are with (**своими**) lab work.
4. (**Наша**) flat has five rooms.
5. Will you tell (**нам**) about London?
6. Is there (**что-нибудь**) on the toolboard?
7. Give me (**любой**) tool, please.
8. He saw (**никого**) in the workshop.

Final Lexical-Grammar Test  
(Term 1. "Basic English for Technical Students" Part 1.) Variant 1

I. Fill in the gaps using the proper preposition.

- 1) I'm good...English
- 2) He is interested...the history of computers
- 3) This is a tool ... driving in nails.
- 4) Take an electric drill and switch it... . Then drill a hole.
- 5) ... the left of the door there is a toolbox.
- 6) These alloys are widely used ... making pipes.
- 7) We remove nails ... tyres ... the help of pliers.
- 8) The beaker is full ... liquid.

II. Complete these sentences with *little/ a little; few/ a few; much, many*.

- 1) The workshop is almost empty. There are very ... people there.
- 2) Would you like some more nails? - Yes, but only ... .
- 3) There is ... cement in the sack. We need some more.
- 4) Do you speak German well? - No, only ... words.
- 5) Tom is very busy. He has so ... work to do.
- 6) Are there any tools **in the workshop**? **Yes, but not...**
- 7) We have to hurry. We haven't got ... time.
- 8) This car uses ... fuel. Let's sell it.

III. Form nouns from the following adjectives.

- |               |               |
|---------------|---------------|
| 1) strong -   | 5) flexible - |
| 2) wide -     | 6) soft -     |
| 3) high -     | 7) plastic -  |
| 4) circular - | 8) hard -     |

IV. Correct mistakes in the given sentences.

- 1) How do you do? - I'm excellent, thanks.
- 2) What is he? - He is Petrov, my groupmate.
- 3) There are a file, a chisel and a spanner on the shelf.
- 4) Is this metal box more heavy that one?

- 5) I wonder what is this tool made of?
- 6) Copper is harder than aluminium.
- 7) What are these called?
- 8) Metal is much stronger than plastic

V. Put questions to these sentences.

- 1) It is impossible to live without metals. *(a general question)*
- 2) Steel, copper and aluminium are widely used in engineering. *(an alternative question)*
- 3) The alloy of copper and zinc is known as brass. *(a general question)*
- 4) Steel and cast iron are in the group of ferrous metals. *(an alternative question)*
- 5) This hammer is made of wood and steel. *(a disjunctive question)*
- 6) There are different types of tools in the toolbox. *(a disjunctive question)*
- 7) We transport people and goods with the help of a car. *(a special question)*
- 8) A manometer is an instrument for measuring pressure. *(a special question)*

VI. Translate the following sentences into English.

- 1) Он – студент-первокурсник энергетического факультета.
- 2) Между прочим, существуют различные виды двигателей.
- 3) Если мне не изменяет память, стальные трубы самые тяжелые и наименее гибкие.
- 4) Насколько мне известно, этот сплав обладает коррозионной устойчивостью.
- 5) Я полагаю, этот станок используется для обработки деталей.
- 6) Мне кажется, горючее для 4-тактных двигателей не содержит масла.
- 7) Без сомнения, у большинства машин двигатель находится спереди.
- 8) Послушай, Алексей, я хочу знать, надежен ли этот измерительный прибор.

Time: 45min  
Total Score: 48 points

Final Lexical-Grammar Test  
(Term 1. “**Basic English for Technical Students**” Part 1.) Variant 2

I. Fill in the gaps using the proper preposition.

- 1) I'm bad ... Physics.
- 2) The students are busy... a new task.
- 3) ... the right of the workshop there is a workbench.
- 4) This device is ... reading a thousandth of an ampere.
- 5) There is a great deal ... petrol ... this fuel mixture.
- 6) The lightest ... these metals is aluminium.
- 7) The text deals ... different properties of ferrous metals.
- 8) Side lights are ... the front of a car.

II. Complete these sentences with *little/ a little; few/ a few; much, many*.

- 1) I have too ... homework to do.
- 2) There are only ... screws on the bench. We need some more.
- 3) We have very ... time left. Let's hurry up.
- 4) There is ... petrol in the tank. Let's go to the country.
- 5) Is there ... carbon in this alloy?
- 6) There are not ... cars with 4-stroke petrol engines.
- 7) This car is expensive to run. It uses ... fuel.
- 8) I have ... relatives in Minsk, therefore I often feel lonely.

III. Form nouns from the following adjectives.

- |                |              |
|----------------|--------------|
| 1) long-       | 5) circular- |
| 2) deep-       | 6) elastic-  |
| 3) high-       | 7) tough-    |
| 4) triangular- | 8) flexible- |

IV. Correct mistakes in the given sentences.

- 1) Who is he? - He is an engineer.
- 2) I'm really impressed with the design of this car.
- 3) I'd like to know where is my screwdriver.
- 4) Is glass brittler than cast iron?

- 5) A laser have its own power source and several lenses.
- 6) These objects has the shape of a cylinder, don't they?
- 7) The wide of the box is 6cm.
- 8) It is the larger car in the garage.

V. Put different questions to these sentences.

- 1) Plastics are lighter than metals. *(a general question)*
- 2) Electric wires are generally made of copper. *(an alternative question)*
- 3) The combination of metals and non-metals is known as an alloy. *(a special question)*
- 4) Metals and non-metals have different properties. *(a disjunctive question)*
- 5) An ammeter is used for measuring current. *(a disjunctive question)*
- 6) There are different instruments in the workshop. *(a disjunctive question)*
- 7) We make holes with the help of electric drill. *(a special question)*
- 8) A thermometer is an instrument for measuring temperature of different bodies liquids and gases. *(an alternative question)*

VI. Translate the following sentences into English.

- 1) Позвольте представиться. Я студент 1-ого курса автотракторного факультета.
- 2) Олег, это мой хороший друг Иван. - Добрый день. - Добрый день.
- 3) По-моему, этот металл обладает свойством износоустойчивости.
- 4) Я считаю, что мотоциклов с дизельным двигателем не существует.
- 5) Видишь ли, свойства сплавов часто лучше свойств их составляющих.
- 6) Ты не мог бы мне дать ту медную проволоку? - Нет, извини.
- 7) Между прочим, этот материал менее твердый, чем тот.
- 8) Насколько я помню, лазер используется для получения мощного пучка света



Intermediate Lexical-Grammar Test  
(Term 2. "Basic English for Technical Students". Part 1) Variant 1

I. Match the English words with their Russian equivalents.

- |               |                                     |
|---------------|-------------------------------------|
| 1. contain    | a. улучшать                         |
| 2. improve    | b. рассматривать вопрос; иметь дело |
| 3. devise     | c. возможность                      |
| 4. deal with  | d. открывать                        |
| 5. apply      | e. опыт работы                      |
| 6. capacity   | f. применять                        |
| 7. discover   | g. создавать; разрабатывать         |
| 8. experience | h. вмещать; содержать в себе        |

II. Match the words with the opposite meaning.

Example: fast – slow

- |              |                 |
|--------------|-----------------|
| 1. increase  | a. disadvantage |
| 2. widen     | b. rest         |
| 3. motion    | c. shorten      |
| 4. advantage | d. start        |
| 5. finish    | e. reduce       |
| 6. accurate  | f. disconnect   |
| 7. simple    | g. inaccurate   |
| 8. connect   | h. complex      |

III. Form nouns from the following verbs.

1. to save -
2. to detect -
3. to improve -
4. to compress -
5. to power -
6. to produce -
7. to install -
8. to adjust -

IV. Complete the sentence with the words from the box below.

1. The students **study ... in the lab every week.**
2. The driver **is measuring ... in the wheels now.**
3. My groupmates were investigating ... at 10 o'clock yesterday.
4. **He will be observing ... of a multimeter in the lab tomorrow.**
5. **My friend usually carries out ... in the laboratory.**
6. **The fuel mixture is ignited in the ... .**
7. **Our groupmates are studying ... of this car.**
8. This fuel is used in all types of ... .

*the experiments; the pressure; superconductors; new devices;  
the indications; engines; the fuel system; combustion chamber*

V. Correct mistakes.

1. I have never saw a robot.
2. **The students didn't have finished the experiment** by the end of the lecture.
3. Robots does their work more efficiently than human beings.

4. The engineers will had constructed a new device by the end of April.
5. The scientists wrote a lot of complicated programs for robots.
6. The engine produce power when air and fuel are mixed and burnt.
7. The fuel tank are connected to a fuel pipe.
8. In the engine the fuel and air is burnt and they produce power.

VI. Put the following verbs into correct tense form.

1. **The car ... at the speed of 80 kph now (to move).**
2. The carburetor ... **for mixing fuel with air (to use).**
3. **The students ... various types of robots in operation (to see).**
4. The alternator ... **enough current now (to produce).**
5. The engineers always ... **the fuel system (to control).**
6. Diesel fuel ... **in different engines (to use).**
7. He ... **the indications of a multimeter in the lab tomorrow (to study).**
8. They ... **in the laboratory from 4 till 6 o'clock yesterday (to work).**

## Final Lexical-Grammar Test

(Term 2. "Basic English for Technical Students". Part 1) Variant 1

I. Match the English words with their Russian equivalents.

- |                   |                             |
|-------------------|-----------------------------|
| 1. alloying steel | a. смола, полимер           |
| 2. resin          | b. легированная сталь       |
| 3. fibre          | c. поглощение               |
| 4. absorption     | d. печь                     |
| 5. furnace        | e. волокно                  |
| 6. chamber        | f. поршень                  |
| 7. piston         | g. рулевое управление       |
| 8. steering       | h. камера; отсек; отделение |

II. Form all possible word combinations using the words of both columns and translate them into Russian.

- |                          |   |
|--------------------------|---|
| 1. to elaborate          | a. the steel making process                 |
| 2. to observe            | b. the plan of the research                 |
| 3. to carry out          | c. with alloying elements                   |
| 4. to demonstrate        | d. different operations on milling machines |
| 5. to experiment         | e. the properties of tool steels            |
| 6. to improve the work   | f. different engines                        |
| 7. to use diesel fuel in | g. in a fuel tank                           |
| 8. to store fuel         | h. the fuel pump                            |

III. Fill in the gaps using the proper prepositions.

1. **Four different scale are used ... temperature measurement.**
2. **Barometers may be classified ... two general types.**
3. **The workshop is equipped ... many machine-tools.**
4. **The students carried ... the experiment yesterday.**
5. **They must compare the results ... two tests.**
6. **Fuel and air are compressed ... the piston.**
7. **The body of the car is supported ... the frame.**
8. **Gases are expelled ... the cylinder.**

IV. Put these statements into the Past Tense and the Future Tense.

1. They can study the properties of engineering materials.
2. The engineer may use these substances for the experiment.
3. The students must attend all practical classes.
4. My friend may demonstrate the new applications of steels.
5. Our engineers can extract copper in several ways.
6. They can control the cooling system.
7. The mechanic must check the fuel system.
8. The engineers can complete the testing of a new vehicle.

V. Choose the correct tense form of the verbs.

1. New oil filters *will have been designed/have been designed* according to tractor specifications recently.
2. A new machine tool *had been devised/has devised* by the end of the week.

3. The workpiece *will have been cut/ had been cut* **by 2 o'clock** tomorrow.
4. The new technology *has applied/ has been applied* recently.
5. He *has just tested/ has just been tested* the new equipment in the laboratory.
6. The course project *has been written/ will have been written* by the end of the term.
7. A new model of a lathe *had been delivered/ has delivered* by the end of our practice.
8. The students *will have published/ will have been published* the article by the beginning of the conference.

VI. Choose the appropriate adverbial modifiers to complete these sentences.

**1. Students at the Technical University ...**

carry out different experiments.

**2. Alex was working in the lab ... .**

**3. They have studied electrical devices ... .**

4. Mary completed the experiment a few minutes ... .

5. The students carried **an experiment** ... .

6. They will graduate from the Technical University ... .

7. **I have ... measured the dimensions of the** workpiece.

8. The students studied three types of electrical units ... .

- a. yesterday
- b. for three years
- c. often
- d. already
- e. last term
- f. in two years
- g. from 5 till 7 yesterday
- h. ago

VII. Translate these sentences from Russian into English.

1. Дизельное топливо используется в различных двигателях.

2. Ценность сплавов была обнаружена в древние времена.

3. Медь широко используется в медицине.

4. Медь была добыта более чем 10 000 лет тому назад.

5. Чистая медь – это ковкий металл.

6. Двигатель является одним из главных компонентов любого транспортного средства.

7. Инженеры всегда контролируют систему охлаждения.

8. Они отремонтировали автомобиль на прошлой недели.

Intermediate Lexical-Grammar Test  
(Term 2. "Basic English for Technical Students". Part 1) Variant 2

I. Match the English words with their Russian equivalents.

- |                               |  |
|-------------------------------|--|
| 1. brakes                     | a. <b>настраивать; регулировать</b>      |
| 2. internal combustion engine | b. <b>коробка передач</b>                |
| 3. compress                   | c. <b>топливный бак</b>                  |
| 4. suspension                 | d. <b>система смазки</b>                 |
| 5. lubrication system         | e. <b>сжигать</b>                        |
| 6. fuel tank                  | f. <b>подвески</b>                       |
| 7. adjust                     | g. <b>двигатель внутреннего сгорания</b> |
| 8. gearbox                    | h. <b>коробка передач</b>                |

II. Match the words with the opposite meaning.

- |                 |                  |
|-----------------|------------------|
| 1. to increase  | a. to close      |
| 2. to open      | b. to reduce     |
| 3. to break     | c. to find       |
| 4. to switch on | d. to repair     |
| 5. to lose      | e. to switch off |
| 6. important    | f. receive       |
| 7. give         | g. indifferent   |
| 8. different    | h. unimportant   |

III. Form nouns from the following verbs.

1. to produce –
2. to conduct –
3. to radiate –
4. to accelerate –
5. to compress –
6. to construct –
7. to detect –
8. to separate –

IV. Complete the sentence with the words from the box below.

1. The engine produces ... when air and fuel are ... and burnt.
2. The fuel system consists of ..., a fuel line or a pipe, a pump and ... .
3. A motor ... is a complex engineering construction.
4. The fuel system is used for ... the engine.
5. One of the main components of any vehicle is the ... .
6. There are four ... mechanisms.
7. These mechanisms are the ..., the lubrication system, the electrical system and the ... .
8. They are used to ... the engine.

*a carburetor; vehicle; feed; a tank; engine; fuel system;  
cooling system; mixed; power; feeding; separate*

V. Correct mistakes in the following sentences.

1. The Ford Company produce cars, trucks and tractors.
2. They has already increased the efficiency of a new car.
3. All these machines have been make of metal.

4. The Professor has been explained the application of filters.
5. The climate control system have been expected by the engineer.
6. These engines has just been tested by our mechanic.
7. The engineers have been manufactured the new acoustic system.
8. They has modified shock absorbers.

VI. Put the following verbs into correct tense form.

1. Oil filters ... **in two days (to test)**.
2. People ... petroleum in all branches of industry (to need).
3. **A motor vehicle** ... a complex engineering construction (to be).
4. These cars ... with the experimental fuel system (to equip).
5. An engine ... **power (to produce)**.
6. They ... pistons form plastics (to make).
7. The driver ... **the pressure in the wheels (to measure)**.
8. **We** ... **various electrical devices all the morning tomorrow (to study)**.

Time: 60 min  
Total Score: 56 points

## Final Lexical-Grammar Test

(Term 2. "Basic English for Technical Students". Part 1) Variant 2

I. Match the English words with their Russian equivalents.

- |                           |                               |
|---------------------------|-------------------------------|
| 1. acoustic system        | a. маслофильтр                |
| 2. brake                  | b. подавать; питать; снабжать |
| 3. pump                   | c. гарантировать              |
| 4. independent suspension | d. насос                      |
| 5. cooling system         | e. тормозное устройство       |
| 6. ensure                 | f. независимая подвеска       |
| 7. feed                   | g. акустическая система       |
| 8. oil filter             | h. система охлаждения         |

II. Form all possible word combinations using the words of both columns and translate them in Russian.

- |                   |                                     |
|-------------------|-------------------------------------|
| 1. to study       | a. power                            |
| 2. to measure out | b. the fuel in the fuel tank        |
| 3. to use         | c. new cars                         |
| 4. to produce     | d. the work of the carburetor       |
| 5. to store       | e. this device                      |
| 6. to design      | f. this fuel in all types of engine |
| 7. to explain     | g. a precise amount of fuel         |
| 8. to check       | h. the fuel system of this car      |

III. Fill in the gaps using the proper prepositions.

1. This device is made ... plastic.
2. **We make holes ... the help ... an electric drill.**
3. **We are studying the fuel system ... this car.**
4. **They provide us ... the necessary equipment.**
5. **Gas is kept ... a special tank.**
6. **Petroleum is needed ... all branches of industry.**
7. Fuel is carried ... the fuel pipe.
8. **Our workshops are equipped ... automatic machinery.**

IV. Put these statements into the Past Tense and the Future Tense.

1. Paul can study a new device in the lab.
2. The driver must measure the pressure in the types.
3. They may use the speedometer to indicate the speed.
4. They can perform mathematical operations.
5. We must study the main components of a motor vehicle.
6. The students must carry out some experiments with different electrical devices.
7. Oleg may test a manometer.
8. They can measure electrical units with a multimeter.

V. Choose the correct tense form of the verbs.

1. We *have been shown/ have shown* an experimental tractor with a 6-cylinder engine lately.
2. The engineers *have already increased/ have already been increased* the efficiency of a tractor.
3. The experiment *had been finished/ will have been finished* before our practical classes were over.
4. The mechanic *will have repaired/ have repaired* the car by the end of next month.

5. A lot of different operations *has been performed/ had been performed* by the end of the practice.
6. All necessary data *had been obtained/ will have been obtained* by the time the experiment began.
7. We *will have improved/ have improved* the acoustical system in this tractor by the end of the year.
8. A new modal of a lathe *will have been delivered/ had been delivered* before a new academic year began.

VI. Choose the appropriate adverbial modifiers to complete these sentences.

- |   |                                 |
|---|---------------------------------|
| 1. Fuel is stored in a fuel tank.                       |                                 |
| 2. They will solve the problem.                         | a. since                        |
| 3. The fuel system was checked.                         | b. usually                      |
| 4. A new device has been installed in the car.          | c. two years ago                |
| 5. He will have reparsed his car.                       | d. recently                     |
| 6. <b>She has been an engineer ... 17 years.</b>        | e. tomorrow                     |
| 7. My friend graduated from the Technical University.   | f. for                          |
| 8. <b>We have been in the laboratory ... 4 o'clock.</b> | g. yesterday                    |
|   | h. by the end of the next month |

VII. Translate these sentences from Russian into English using your active vocabulary.

1. Эти автомобили будут отремонтированы через 2 недели.
2. Тестирование нового транспортного средства будет закончено к концу месяца.
3. Это топливо не будет использоваться в этом автомобиле.
4. Топливо и воздух сгорают в двигателе и вырабатывают энергию.
5. Электрические насосы обычно расположены около двигателя.
6. Воздух и топливо сжимаются поршнем.
7. Топливо обычно хранится в топливном баке.
8. Система охлаждения будет проконтролирована инженером.



## Final Lexical-Grammar Test

(Term 3. “**Basic English for Technical Students**” Part 2.) Variant 1

1. Match the verbs with the similar meaning.

- |               |                 |
|---------------|-----------------|
| 1. to create  | a) to carry out |
| 2. to hold    | b) to make up   |
| 3. to perform | c) to capture   |
| 4. to convert | d) to keep      |
| 5. to absorb  | e) to purify    |
| 6. to supply  | f) to turn into |
| 7. to clean   | g) to break     |
| 8. to damage  | h) to provide   |

2. Match the words with the opposite meaning.

- |                  |                 |
|------------------|-----------------|
| 1. insulator     | a) excess       |
| 2. direct        | b) dangerous    |
| 3. to accelerate | c) to slow down |
| 4. shortage      | d) alternating  |
| 5. safe          | e) conductor    |
| 6. initial       | f) cheap        |
| 7. to decrease   | g) final        |
| 8. expensive     | h) to increase  |

3. Match the English words with the Russian equivalents.

- |                               |                               |
|-------------------------------|-------------------------------|
| 1. freezing point             | a) <b>одноцветный</b>         |
| 2. flat battery               | b) <b>ископаемое горючее</b>  |
| 3. fuel mixture               | c) <b>солнечный коллектор</b> |
| 4. alternative energy sources | d) <b>разряженная батарея</b> |
| 5. fossil fuel                | e) <b>точка замерзания</b>    |

- |                    |                                     |
|--------------------|-------------------------------------|
| 6. solar collector | f) электростанция                   |
| 7. power plant     | g) топливная смесь                  |
| 8. single-colour   | h) альтернативные источники энергии |

4. Fill in the gaps with the suitable derivative of the word given in brackets.

- 1) **Scientists and engineers carry out research and solve important ...** problems in computer engineering. (*science*)
- 2) The **most ... machine in the workshop is a lathe.** (*to use*)
- 3) **Automation of all ... processes** is of great importance nowadays. (*industry*)
- 4) **There are many ... institutions that teach computer programming.** (*education*)
- 5) **At first handling ... were carried out** manually. (*to operate*)
- 6) The industrial robot is a general – **purpose, ... machine.** (*to program*)
- 7) **For many years the Ford Company has been deeply involved in the ... of** tractors, cars and trucks. (*to produce*)
- 8) This ... became very popular because it gave off much heat. (*to invent*)

5. Restore the original sentences.

- 1) to provide, is, current, at a low voltage, it, necessary
- 2) to be performed, very important, the functions, are, by this device
- 3) this device, an electrical charge, enables, to be built up and stored
- 4) the transformer, to be increased or decreased, the voltage, allows
- 5) are known, semiconductors, to be made of, silicon
- 6) valuable, this new substance, to possess, is sure, properties
- 7) changing, must, a burnt bulb, the person, switch off, first of all, the power
- 8) **when, the car, repairing, the mechanic's instructions, I, followed**

6. Correct mistakes the following sentences.

- 1) You should to put on special clothing to protect yourself.

- 2) **Drivers must don't speed, especially when they see speed limit signs.**
- 3) The flow of water makes the wheel to turn.
- 4) The assistant warned them not create a magnetic field.
- 5) This information said to be of utmost importance.
- 6) This system reports to be pollution-free.
- 7) I saw Boris being repaired an electrical device in the lab.
- 8) Water and wind power using extensively today seem to be inexhaustible.

7. Translate the following sentences into Russian.

- 1) To supply the current it is necessary to use a transformer.
- 2) This allowed the rules to be followed.
- 3) This method is expected to offer some advantages.
- 4) In the laboratory I found the students studying the work of a switching device.
- 5) The substance to be analysed is of great value.
- 6) Being subjected to high temperatures aluminium loses its strength rapidly.
- 7) Having lost some of its electrons, the atom has a positive charge.
- 8) They were discussing the experiment being carried out in the lab.

8. Translate the following sentences into English using your active vocabulary.

- 1) Обычно используют трансформатор, чтобы подать необходимый ток.
- 2) Лазерная сварка используется для сварки сталей.
- 3) Моя задача заключается в том, чтобы найти неисправность в этом приборе.
- 4) Вот термостат, который нужно заменить.
- 5) Мне нужно, чтобы он отключил электричество.
- 6) Магнит заставляет ток менять направление.
- 7) Похоже, ваш проект имеет ряд преимуществ.
- 8) Будучи серьёзно повреждённой, машина не заводилась.

9. Complete this text by choosing one of the words given below.

### Atoms and Molecules

As you probably know everything in the world, whether solid, **1( .... )**, or gas, is made up of atoms. Each **2( .... )** contains some number of **3( .... )**, **4( .... )**, **5(.... )**. The **6( .... )** of each atom contains the protons and neutrons. Since electrons and protons are **7( .... )**, each atom prefers to have the same number of electrons and protons. Atoms of one or more types are organized into **8( .... )**. There are only a hundred or so types of atoms, but there are an almost infinite number of different molecules. Molecules are the **9( .... )** from which all real objects are made. Molecules are not always so simple. Some **10( .... )** can comprise hundreds of atoms.

*Electrons, protons, neutrons, liquid, atom, nucleus, charged particles, organic molecules, building blocks, molecules*

## Final Lexical-Grammar Test

(Term 3 “ Basic English for Technical Students” Part 2.) Variant 2

1. Match the verbs with the similar meaning.

- |               |                 |
|---------------|-----------------|
| 1. to hold    | a) to tackle    |
| 2. to contain | b) to consider  |
| 3. to possess | c) to keep      |
| 4. to solve   | d) to include   |
| 5. to think   | e) to own       |
| 6. to convert | f) to replace   |
| 7. to enter   | g) to get into  |
| 8. to change  | h) to turn into |

2. Match the words with the opposite meaning.

- |                |              |
|----------------|--------------|
| 1. to contract | a) to absorb |
| 2. shortage    | b) internal  |
| 3. external    | c) to expand |
| 4. to start    | d) excess    |
| 5. to emit     | e) lack      |
| 6. perfect     | f) to finish |
| 7. abundance   | g) single    |
| 8. numerous    | h) imperfect |

3. Match the English words with the Russian equivalents.

- |                        |                                  |
|------------------------|----------------------------------|
| 1. fine particles      | a) <b>первичная обмотка</b>      |
| 2. direct current      | b) <b>замкнутая цепь</b>         |
| 3. closed circuit      | c) <b>мелкие частицы</b>         |
| 4. primary winding     | d) <b>прямой ток</b>             |
| 5. renewable resources | e) <b>правило безопасности</b>   |
| 6. spark plug          | f) <b>воздушный зазор</b>        |
| 7. safety rules        | g) <b>свеча зажигания</b>        |
| 8. air gap             | h) <b>возобновляемые ресурсы</b> |

4. Fill in the gaps with the suitable derivative of the word given in brackets.

- 1) Scientists carry out research and solve important ... problems in computer engineering. (*science*)
- 2) The ... **of modern equipment** is greater than that of the old one. (*effective*)
- 3) The robot can relieve human ... **from hazardous work**. (*to operate*)
- 4) What he needed was a ... **lamp**. (*safe*)
- 5) At that time people were ... afraid of lightning. (*terrible*)
- 6) His ... **could now be used to protect tall buildings during the storm**. (*to discover*)
- 7) ... machines made people more efficient in their everyday job. (*power*)
- 8) **The ... robot is a general** – purpose, programmable machine. (*industry*)

5. Restore the original sentences.

- 1) to provide, is, current, at low voltage, it, necessary.
- 2) to be performed, very important, the functions, are, by this device.
- 3) the transformer, to be increased or decreased, the voltage, allows.
- 4) numerous, to offer, solar heaters, seem, advantages.
- 5) valuable, this new substance, to possess, is sure, properties.
- 6) The operator, by, having been adjusted, continued to work, the machine tool.
- 7) With some other metals, gets, aluminium, when alloyed, much better characteristics.
- 8) Being carried out, the investigations, were, of, great importance.

6. Correct mistakes in the following sentences.

- 1) To join these plates it is rather difficult.
- 2) You have to wear uniform be safe.
- 3) When the driver notices the fault in the car it essential to repair it at once.
- 4) His discovery allowed an invention be made.
- 5) Young specialists known to be professionals in their field.
- 6) I saw Boris being repaired an electrical device in the lab.
- 7) Vehicles driving automatically will appear on the market soon.

8) When repaired the car I **followed the mechanic's instructions.**

7. Translate the following sentences into Russian.

- 1) Servicing your car regularly you prevent it from becoming unreliable.
- 2) Being designed carefully the project promises good results.
- 3) Having been repaired by a good mechanic the car was as good as new.
- 4) Scientific investigations carried out in this lab were of great value.
- 5) In the future we are certain to have vehicles moving at a greater speed.
- 6) The equipment to be installed in the work shop has specific use.
- 7) The instructor told the students to connect the ammeter to the circuit.
- 8) Semiconductors are known to be made of silicon.

8. Translate the following sentences into English using your active vocabulary.

- 1) **Строя дома на солнечных батареях, мы сохраняем энергию.**
- 2) **Научные исследования, которые проводились в лаборатории, были очень ценными.**
- 3) **Автомобиль, который работает на солнечной энергии, не загрязняет окружающую среду.**
- 4) **После того, как я обнаружил неисправность, я остановил автомобиль.**
- 5) **Функция этого прибора - измерять давление в системе.**
- 6) **Чтобы подать необходимый ток, используют трансформатор.**
- 7) **Мне нужно, чтобы он отключил электричество.**
- 8) **Считается, что потребление энергии будет увеличиваться.**

9. Complete this text by choosing one of the words given below.

## Current

Current is the **1(...)** rate of the electrons through the **2(...)**. The **3(...)** that force the current to flow is measured in **4(...)**. **5(...)** and current are not the same thing, although they are closely related. In simple terms, voltage causes current. But current, not voltage, does the work in **6(...)**. The flow of water through a **7(...)** is what makes the turbine spin. The flow of **8(...)** through an electrical circuit is what lights the **9(...)**. Routing and controlling the **10(...)** is the goal of every electrical circuit.

*Circuit, pressure, flow, electrical circuits, volts, turbine, voltage, flow of current, bulb, current.*



## Intermediate Lexical-Grammar Test

### (Term 3. "Basic English for Technical Students" Part 2.) Variant 1

1. Match the words with the similar meaning.

- |              |                 |
|--------------|-----------------|
| 1. to affect | a) large        |
| 2. capacitor | b) to influence |
| 3. insulator | c) cause        |
| 4. huge      | d) condenser    |
| 5. reason    | e) dielectric   |
| 6. to start  | f) to cover     |
| 7. to coat   | g) dirt         |
| 8. impurity  | h) to begin     |

2. Match the words with the opposite meaning.

- |                |                 |
|----------------|-----------------|
| 1. to decrease | a) to discharge |
| 2. initial     | b) to increase  |
| 3. direct      | c) final        |
| 4. to charge   | d) alternating  |
| 5. huge        | e) dangerous    |
| 6. safe        | f) insulator    |
| 7. soft        | g) hard         |
| 8. dielectric  | h) small        |

3. Form the derivatives:

a) (*nouns from the following verbs*)

- |                |               |
|----------------|---------------|
| 1. to expand   | 5. to pollute |
| 2. to consume  | 6. to collect |
| 3. to contract | 7. to start   |
| 4. to rotate   | 8. to mix     |

b) (*adjectives from the following nouns*)

- |           |           |
|-----------|-----------|
| 1. beauty | 5. danger |
|-----------|-----------|

- |                |         |
|----------------|---------|
| 2. interest    | 6. atom |
| 3. culture     | 7. rain |
| 4. electricity | 8. wind |

4. Restore the original sentences.

1. an electric current, source of power, a, is needed, to conduct.
2. to be covered, ten miles, to, was equal, the distance.
3. to make, more elastic, rubber, in order, to mix, it, is, with sulphur, it.
4. reliable results, is, this method, to give, not accurate enough.
5. the strength of the current, know, we, on the resistance, to depend, of the circuit.
6. this material, to test, wanted us, the professor, as soon as possible.
7. the temperature, watched, they, rise gradually.
8. new material, in industry, to be used, know, we.

5. Translate the following sentences into Russian.

1. In order to measure temperature it is necessary to choose some kind of temperature scale.
2. It is to be remembered that atoms interact with each other.
3. Copper to be used for tubing has high corrosion resistant qualities.
4. **It is to be remembered that the object of Joule's experiment** was to obtain the relation between heat and work.
5. The ancient scientists believed a molecule to be the smallest particle of a substance.
6. Everyday observations show hot objects to radiate much more heat than cold ones.
7. The addition of some new elements allows new substances with new properties to be obtained.
8. This causes metal to become softer than before.

6. Translate the following sentences into English.

1. Функция этого прибора—измерять давление в цепи.
2. Моя задача заключается в том, чтобы найти неисправность в этом приборе.
3. Новая топливная система, которую нужно установить, является очень эффективной.
4. Чтобы сварить две металлические пластины, их необходимо размягчить.
5. Следовать правилам техники безопасности совсем несложно.
6. Этот прибор позволяет нам измерить напряжение в цепи.
7. Магнит заставляет ток менять направление.
8. Преподаватель попросил студентов заменить перегоревшую лампочку.

Time: 45 min  
Total Score: 56 points

Intermediate Lexical-Grammar Test  
(Term 3. 'Basic English for Technical students Part 2.) Variant 2

1. Match the words with the similar meaning.

- |               |              |
|---------------|--------------|
| 1) flame      | a) essential |
| 2) to hold    | b) fire      |
| 3) aim        | c) to keep   |
| 4) important  | d) quantity  |
| 5) amount     | e) purpose   |
| 6) to clean   | f) to use    |
| 7) to consume | g) to purify |
| 8) petrol     | h) gasoline  |

2. Match the words with the opposite meaning.

- |                  |                 |
|------------------|-----------------|
| 1) to accelerate | a) to separate  |
| 2) to expand     | b) to preserve  |
| 3) to join       | c) to contract  |
| 4) to damage     | d) to slow down |
| 5) powerful      | e) positive     |
| 6) to turn out   | f) weak         |
| 7) negative      | g) to turn into |
| 8) single        | h) numerous     |

3. Form the derivatives:

a) (*nouns from the following verbs*)

- |                |                 |
|----------------|-----------------|
| 1. to equip    | 5. to weld      |
| 2. to compress | 6. to transform |
| 3. to produce  | 7. to divert    |
| 4. to fuse     | 8. to solve     |

b) (adjectives from the following nouns)

- |             |               |
|-------------|---------------|
| 1. care     | 5. sun        |
| 2. power    | 6. inventions |
| 3. industry | 7. science    |
| 4. comfort  | 8. history    |

4. Restore the original sentences.

1. an electric arc welding, two workpieces, to join, is used.
2. a strong join, the workpieces, to make, of the same metal, must be.
3. the speed, to indicate, of the speedometer, the purpose, is, of a car.
4. should be, to be delivered, clean, the petrol, to the carburetor.
5. the pressure, to be controlled, allow, these instruments, continuously.
6. some time, requires, the question, to be answered.
7. the piston, move, made, steam.
8. she, him, the contacts, wanted, of the circuit, to connect.

5. Translate the following sentences into Russian.

1. To make a strong joint is very important.
2. It is absolutely necessary to put on protective clothing.
3. To check the ammeter it is necessary to connect it to the circuit.
4. The new battery to be used in the car is very effective.
5. The equipment to be installed in the workshop has specific use.
6. The new working conditions permitted these complicated problems to be solved.
7. Alice expected Paul to connect the contacts of the circuit.
8. This device enables the current in the circuit to be measured.

6. Translate the following sentences into English.

1. Чтобы защитить себя, тебе следует надеть защитную спецодежду.
2. Сварить эти две металлические пластины совсем нетрудно.

3. Вот автомобиль, который нужно отремонтировать.
4. Новый аккумулятор, который нужно установить, очень эффективный.
5. Преподаватель попросил студентов измерить напряжение в цепи.
6. Мы хотели бы, чтобы вы протестировали этот прибор.
7. Он обнаружил, что спидометр сломался.
8. Научный руководитель хотел, чтобы мы изменили постоянный ток на переменный.

Intermediate Lexical-Grammar Test  
(Term 4. "Basic English for Technical Students" Part 2.) Variant 1

1. Match the words with the similar meaning.

- |                |                  |
|----------------|------------------|
| 1. visible     | a. usage         |
| 2. to separate | b. to coat       |
| 3. to light    | c. whole         |
| 4. to cover    | d. viewable      |
| 5. image       | e. to split      |
| 6. complete    | f. to illuminate |
| 7. strong      | g. powerful      |
| 8. application | h. picture       |

2. Match the words with the opposite meaning.

- |              |                |
|--------------|----------------|
| 1. different | a. the same    |
| 2. abundant  | b. damage      |
| 3. to split  | c. to combine  |
| 4. to create | d. artificial  |
| 5. natural   | e. simple      |
| 6. to send   | f. to receive  |
| 7. complex   | g. contraction |
| 8. expansion | h. rare        |

3. Translate the following sentences into Russian.

1. I saw him splitting the laser beam into two separate beams.
2. **We'd like to have the dimensions of the object checked.**
3. Holograms being mass-produced, it is advisable to divide them into categories.
4. **I don't mind creating a new device.**
5. The importance of gathering new data seems obvious.
6. We know of lasers having numerous applications
7. **I'm sure of your having read this article earlier.**
8. Hologram is a 3D image, special equipment being necessary for producing it.

4. Correct mistakes in the following sentences.

1. Scientists invented a new way investigating space.
2. Do you mind of my testing this device.
3. The idea use robots is very old.
4. Science is worth in developing.

5. I'm sorry at being late.
6. We suggest to buying new equipment.
7. The teacher insisted to using new method of calculations.
8. Robots ideal for doing different jobs.

5. Restore the original sentences.

1. impossible, machines, thinking, to create, it is.
2. is assumed, to have, the device, many faults.
3. is not, compiling, a complex task, a programme.
4. analysing, we, interested, this phenomenon, were, in.
5. worth, it is, devices, buying, high-quality.
6. suggest, they, another, using, actuator.
7. our, carrying out, he, the lab work, on, insisted.
8. to test metals, are used, for strength, special machines.

6. Translate the following sentences into English.

1. Я хотел бы, чтобы расщепитель электронного луча протестировали.
2. Идея создания робота не нова.
3. Как насчет того, чтобы составить программу?
4. Люди продолжают находить все новые применения для роботов.
5. Будучи самым изобильным элементом во вселенной, водород имеет много применений.
6. Мы настаиваем на покупке нового робота.
7. Ты не возражаешь, если я воспользуюсь твоим компьютером?
8. Изучение промышленных газов очень важно.



Intermediate Lexical-Grammar Test  
(Term 4. "Basic English for Technical Students" Part 2.) Variant 2

1. Match the words with the similar meaning.

- |                |                 |
|----------------|-----------------|
| 1. precise     | a. evidence     |
| 2. capable     | b. surroundings |
| 3. creature    | c. able         |
| 4. data        | d. one more     |
| 5. clever      | e. exact        |
| 6. additional  | f. to carry out |
| 7. to perform  | g. intelligent  |
| 8. environment | h. human-being  |

2. Match the words with the opposite meaning.

- |             |              |
|-------------|--------------|
| 1. repair   | a. to absorb |
| 2. shortage | b. excess    |
| 3. perfect  | c. break     |
| 4. to emit  | d. specific  |
| 5. use      | e. imperfect |
| 6. boiling  | f. harm      |
| 7. liquid   | g. freezing  |
| 8. usual    | h. solid     |

3. Translate the following sentences into Russian.

1. **I can't imagine Pete experimenting with a laser beam.**
2. **I'd like to have the beam-splitter tested.**
3. The latest achievements being applied, holography has developed greatly.
4. **We don't mind testing artificial intelligence.**
5. The necessity of supervising robots sounds obvious.
6. We know of alternative sources of energy being used in Belarus.
7. Holograms can be homemade, safety rules being strictly observed.
8. Holography being an art. **It attracts people's attention and curiosity.**

4. Correct mistakes in the following sentences.

1. People get tired in doing the same work.
2. What is the use creating new robots?
3. They suggest of using new equipment
4. A robot is capable at performing various tasks.

5. I insist to your coming on time.
6. We object at the air being polluted.
7. A robot is good on doing repetitive work.
8. Invented the laser man expanded his possibilities.

5. Restore the original sentences.

1. are known, different metals, at different speeds, to be machined.
2. stand, must never, of the cutting laser beam, on the way, you.
3. steel, oxygen, being used, we know of, in making.
4. helium, , is capable, of, aircraft, lifting.
5. many gases, we know, of, in, used, industry.
6. **imagine, can't, eating, without, ice**-cream, we, our life.
7. machined, is, easily, grey cast iron.
8. a source of destruction, when treated inadequately, becomes, the laser.

6. Translate the following sentences into English.

1. Я хотел бы, чтобы телевизор выключи.
2. Идея создания разумной машины очень стара.
3. Я предлагаю купить новое оборудование.
4. Есть ли трудности в управлении этим роботом?
5. Мы знаем, что азот используется в металлургии.
6. Ты не против, если я тебе помогу?
7. Я был сильно удивлён, что Алиса делает голограмму без чьей либо помощи.
8. Применяв новые технологии, мы сильно увеличили производительность.

Final Lexical-Grammar Test  
(Term 4. “Basic English for Technical Students” Part 2.) Variant 1

1. Match the words with the similar meaning.

- |            |              |
|------------|--------------|
| 1. clever  | a. precisely |
| 2. perform | b. smart     |
| 3. exactly | c. powerful  |
| 4. strong  | d. break     |
| 5. damage  | e. separate  |
| 6. single  | f. carry out |
| 7. wire    | g. coat      |
| 8. cover   | h. lead      |

2. Match the words with the opposite meaning.

- |               |                |
|---------------|----------------|
| 1. the same   | a. to absorb   |
| 2. natural    | b. contraction |
| 3. to clean   | c. to pollute  |
| 4. colourful  | d. different   |
| 5. to connect | e. man-made    |
| 6. shortage   | f. to split    |
| 7. expansion  | g. colourless  |
| 8. to emit    | h. excess      |

3. Translate the following sentences into Russian.

1. A beam –splitter having been repaired, the students began to make a hologram.
2. **Running on hydrogen this car isn't likely to cause pollution.**
3. An empty tank is certain to cause a problem.
4. He complained of my working slowly.
5. Having complained of my working slowly he left the room.
6. The short circuit is reported to have caused a lot of damage.
7. That appears to be a solution to the problem.
8. The material to be investigated is of great value.

4. Translate the following sentences into English.

1. Похоже, автомобиль нуждается в ремонте.
2. Науку стоит развивать.

3. В дизельном топливе много углерода и мало серы.
4. Перезарядив аккумулятор, он смог завести двигатель.
5. Вещество, которое нужно исследовать, имеет большую ценность.
6. Я не возражаю против того, чтобы иметь работа дома.
7. Ты знаешь, как шаттлы находят дорогу в космосе?
8. Мы против того, чтобы транспорт загрязнял атмосферу.

5. Choose the right option.

1. **После того как свечу очистили** the spark plug gave a spark.  
*a) cleaned                      b) having been cleaned                      c) cleaning.*
2. **При нагревании** metals expand.  
*a) when heated                      b) when heating                      c) having heated*
3. New possibilities for **применения** electric cars open up.  
*a) having applied                      b) applying                      c) having applying.*
4. **The miners didn't** know what **вызвало** the explosion.  
*a) cause                      b) caused                      c) had caused*
5. We are sure new vehicles **will be** widely **used** in future.  
*a) будут широко использовать                      b) используют                      c) будут широко использоваться*
6. The explanation **данное** isn't complete.  
*a) given                      b) being given                      c) giving*
7. The new vehicles were reported **to be under development**.  
*a) разработали                      в) разрабатываются                      c) будут разработаны*
8. **While calculating** the speed the student made a mistake.  
*a) вычисляя                      b) вычисляющий                      c) вычислительный*

6. Choose the appropriate adverbial modifiers to complete the sentences.

- |  |                            |
|--|----------------------------|
| 1. A new truck has been delivered to the shop                | a) look                    |
| 2. The students will have learnt everything about the engine | b) just                    |
| 3. He had never studied the cooling system                   | c) in the 1960s            |
| 4. Gas is kept in a special tank                             | d) before                  |
| 5. You will graduate from the university                     | e) by the end of the term  |
| 6. They were checking the pressure in the tyres              | f) in 4 years              |
| 7. The first lasers appeared                                 | g) usually                 |
| 8. They are studying different types of fuels                | h) the whole day yesterday |

7. Complete the sentences inserting the proper derivatives.

1. Copper and aluminium are often (mixture) to form an alloy.
2. The computer memory is capable of (to store) a lot of information.
3. Engineering metals to be discussed have wide industrial (to apply).
4. A problem solved by a digital computer must be (expression) in mathematical terms.

5. Energy is both an everyday word and a (science) term.
  6. Lomonosov was the first to indicate the (different) between the atoms and the molecules.
  7. Data and (instructor) must be given to the computer to act on.
  8. These instruments are designed to (measuring) radiation.
8. Complete this text by choosing one of the words given below.

### History of industrial robotics

The first company **1(....)** a robot was Unimation, founded by Devol and Joseph F. Engelberger in 1956. Unimation robots were also called **2(....)** since their main use at first was **3(...)** objects from one point to another. These robots used **4(....)**. They were **5(...)** to within 1/10,000 of an inch. In the late 1970s several big Japanese conglomerates began to produce **6(....)**.

In 1969 Victor Scheinman at Stanford University **7(....)** an all-electric, 6-axis articulated robot, designed **8(....)** an arm solution. This allowed it accurately to follow arbitrary paths **9(...)** and widened the potential use of the robot to more sophisticated applications such as **10(...)** and **11(...)**. Scheinman then **12(...)** a second arm for the MIT AI Lab, called the "MIT arm" and after that sold those designs to Unimation.

*To produce, invented, hydraulic actuators, assembly, welding, programmable transfer machines, in space, designed, similar industrial robots, to permit, accurate, to transfer*

Final Lexical-Grammar Test  
(Term 4. “**Basic English for Technical Students**” Part 2.) Variant 2

1. Match the verbs with the similar meaning.

- |                |                  |
|----------------|------------------|
| 1. the amount  | a. to remove     |
| 2. to clean    | b. quantity      |
| 3. to reduce   | c. to change     |
| 4. to replace  | d. to decrease   |
| 5. impurity    | e. to repair     |
| 6. to overhaul | f. dust and dirt |
| 7. chain       | g. insulator     |
| 8. dielectric  | h. circuit       |

2. Match the words with the opposite meaning.

- |              |                |
|--------------|----------------|
| 1. to cool   | a. abundant    |
| 2. expansion | b. solid       |
| 3. to absorb | c. to emit     |
| 4. to freeze | d. contraction |
| 5. liquid    | e. to heat     |
| 6. safe      | f. dangerous   |
| 7. natural   | g. to boil     |
| 8. rare      | h. artificial  |

3. Translate the following sentences into Russian.

1. Having cleaned the spark plugs, I could easily start the engine.
2. Dirty spark plugs are sure to cause a problem.
3. You are not likely to know English well.
4. **I'm sure of your having read the article earlier.**
5. The latest achievements being applied, holography has developed considerably.
6. Having read the article he returned it to the library.
7. Second-year students are expected to know Physics well.
8. These batteries seem to be overcharged.

4. Translate the following sentences into English.

1. **Эту машину стоит купить.**
2. **Транспортные средства, как известно, имеют различные типы двигателей.**
3. **Возможно, автомобиль имеет серьезные повреждения.**
4. **Они не возражали, чтобы я им помог.**

5. Мне интересно, из чего состоят шатлы.
6. Идея проверить свечи зажигания не моя.
7. Оборудование, которое должно быть установлено, совершенно новое.
8. Сколько масла в этой горючей смеси?

5. Choose the right option.

1. После того, как система зажигания была отремонтирована, he could easily start the engine.

- a) *the ignition system repaired*    b) *the ignition system having been repaired*  
 c) *the ignition system repairing.*

2. Сборка cars isn't easy.

- a) *assembling*    b) *assembled*    c) *being assembled*

3. Получив good results we stopped the research.

- a) *receiving*    b) *being received*    c) *having received*

4. You can improve the efficiency of your car by применением modern technologies.

- a) *having applying*    b) *applying*    c) *having applied*

5. They were sure that the fault была найдена.

- a) *find*    b) *had found*    c) *had been found*

6. The article said that many cars had been damaged.

- a) *повредили*    в) *повреждают*    с) *было повреждено*

7. The game сыгранная yesterday was not interesting.

- a) *playing*    b) *having played*    c) *played*

8. The first real calculating machine appeared in 1820.

- a) *вычисления*    в) *вычислительная*    с) *вычислили*

6. Choose the appropriate adverbial modifiers to complete the sentences.

- |   |                            |
|---|----------------------------|
| 1. The transmission control has been improved.    | a) now                     |
| 2. The students will have tested all the devices. | b) today                   |
| 3. Why are cars so widely used                    | c) just                    |
| 4. The students had not seen a robot              | d) before                  |
| 5. We carried our final test                      | e) yesterday,              |
| 6. They are drawing graphs                        | f) by the end of the week  |
| 7. He has been repairing his car                  | g) from 4 till 6 yesterday |
| 8. I was waiting for you in the lab               | h) since morning           |

7. Complete the sentences inserting the proper derivatives.

1. There exist (vary) forms of energy.
2. A computer is (capability) of performing different kinds of operations.
3. The greater the (conductor) of the substance the less is its resistance.
4. Software is considered to be a set of (instructor) that tell a computer how to work.

5. This body is (ability) to work.
6. You can easily find the information which is (to store) in your computer.
7. There are two common methods for (measured) velocity.
8. The method to be (application) for solving this problem is very simple.

8. Complete this text by choosing one of the words given below.

### Robot types

In the context of general robotics, most types of **1(...)** would fall into the **2(...)** of robotic arms. Robots exhibit varying degrees of **3(...)**:

Some robots are **4(...)** to carry out **5(...)** without variation and with a high degree of **6 (...)**. These actions are determined by programmed routines that specify the direction, acceleration, velocity and distance of a series of **7(...)**.

Other robots are much more **8(...)** as to the orientation of the object on which they are operating or even the task that has to be performed on the object itself, which the robot may even need to identify. For example, for more **9(...)**, robots often contain machine vision sub-systems acting as their "eyes", linked to powerful **10(...)** or controllers. **11(...)** is becoming an increasingly important factor in the **12(...)**.

*category, autonomy, robots, accuracy, programmed, coordinated motions, precise guidance, artificial intelligence, modern industrial robot, computers, flexible, repetitive actions.*



Intermediate Lexical-Grammar Test 1 (Units 1-3)

**Вариант I**

**I. Выберите правильное определение для каждого данного слова и переведите их на русский язык.**

ring road, route, congestion, safety, traffic, operator

1. the state of being overcrowded, especially with traffic or people
2. a way between two places that buses, planes, ships, etc. regularly travel
3. freedom from danger or risk of injury
4. the movement of vehicles, people in a particular place or for particular purpose
5. main road that bypasses a town or town center
6. a person who owns or operates an industrial or commercial establishment

*Score: 6*

**II. Переведите выделенные слова на английский язык.**

1. The use of (колёсных транспортных средств) encouraged construction of better roads.
2. (Дорожная транспортная система) requires a level (организации труда) and administrative control that could be (обеспечено) by a (центральным правительством).
3. The union has (систематизировал) and simplified the (обычные) administrative procedures in sector where the safety is very important.
4. Many EU (правил) applying to (грузовики) also concern buses and (пассажирские автобусы).
5. The need to (делить) infrastructure with other road (пользователями) raises the important questions of road safety.
6. The (сектор дорожных перевозок) is the victim of its own success.
7. The Interbus (соглашение) is a key instrument for liberalizing the important passenger road transport market between the Union and countries of central and Eastern Europe.

*Score: 14*

**III. Подберите синонимы и переведите их на русский язык.**

Fine, haulage, legislation, penalty, law, transportation, surveillance, reduce, emission, observation, decrease, release.

*Score: 6*

**IV. Переведите на русский язык следующие словосочетания.**

1. the Silk Road
2. all weather transcontinental highway

3. wheeled vehicles
4. waterproof road surfaces
5. traffic density
6. road traffic emission
7. bus occupancy
8. automatic number plate recognition technology
9. fossil fuel consumption
10. traffic flows
11. noise level
12. the vehicle registration number
13. rush-hour traffic intensity

Score: 13

V. **Выберите правильный вариант перевода, обращая внимание на перевод Participle 2.**

1. Air pollution *caused* by intensive car, lorry and air traffic is finally starting to worry.  
a) *вызывая* b) *вызывающая* c) *вызванная*
2. The total journey time by public transport consists of time *taken* to get to or from bus –stop, the waiting time and the time on board the vehicle.  
a) *занимая* b) *занимающее* c) *занимаемое*
3. *Based* on literature study and laboratory test, full scale tests should be carried out on existing roads.  
a) *основываясь* b) *основывая* c) *основанный*
4. The distribution services *offered* included warehousing, administration, order processing and the control of the goods flowing via the transport network.  
a) *предлагая* b) *предлагаемое* c) *предложенное*
5. Transport services *provided* in return for money can be classed as third-party operations.  
a) *обеспечивая* b) *предоставленные* c) *предоставляющие*
6. The investigation *carried out* is based on data from the road surface measurements *made* on stale roads and accidents reported by the police.  
*carried out* a) *проводя* b) *проводимое* c) *проведённое*  
*made* a) *сделанные* b) *дела* c) *делающие*

Score: 7

Total score: 46

(45 минут)

Intermediate Lexical-Grammar Test 1 (Units 1-3)

**Вариант II**

**I. Выберите правильное определение для каждого данного слова и переведите их на русский язык.**

freeway, legislation, route, congestion, safety, traffic

1. the state of being overcrowded, especially with traffic or people
2. a way between two places that buses, planes, ships, etc. regularly travel
3. freedom from danger or risk of injury
4. the movement of vehicles, people in a particular place or for particular purpose
5. a very wide road in the US, built for fast travel
6. the act or process of making laws

*Score: 6*

**II. Переведите выделенные слова на английский язык.**

1. The steady growth of (сектора дорожных перевозок) contributes to the (насыщенность) of the capacity of European roads.
2. This agreement is a major step towards harmonizing, within the Europe, (правила и процедуры) which transport operators have to (выполнять).
3. (Транспортная система) requires a level of (организации труда) and administrative control that could be (обеспечено) by a (центральным правительством).
4. The union has (систематизировал) and simplified the (обычные) administrative procedures in the sector where the safety is very important
5. The need to (делить) infrastructure with other road (пользователями) raises the important questions of road safety.
6. The (сектор дорожных перевозок) is the victim of its own success.
7. The Interbus (соглашение) is a key instrument for liberalizing the important passenger road transport market between the Union and countries of Central and Eastern Europe.

*Score: 14*

**III. Подберите синонимы и переведите их на русский язык.**

Revenue, pollution, fine, haulage, legislation, penalty, law, transportation, surveillance, reduce, emission, observation, decrease, income.

*Score: 7*

IV. **Переведите на русский язык следующие словосочетания.**

1. land transportation networks
2. market observation system
3. traffic capacity
4. waterproof road surfaces
5. traffic density
6. road traffic emission
7. bus occupancy
8. automatic number plate recognition technology
9. fossil fuel consumption
10. traffic flows
11. noise level
12. the vehicle registration number
13. rush-hour traffic intensity

Score: 13

V. **Выберите правильный вариант перевода, обращая внимание на перевод Gerund.**

1. *Using* a satellite based system to levy the charge will allow for the further variation to be implemented

a) *используя* b) *использование* c) *чтобы использовать.*

2. *Varying* the charge by distance travelled within the UK ensured that all the vehicles contribute equally irrespective of their country of registration.

a) *изменяя* b) *изменение* c) *чтобы изменить*

3. *Distinguishing* by vehicle type ensures that the charge relates both to road damage costs and to environmental costs.

a) *отличаясь* b) *выделение* c) *чтобы отличить*

4. There is little scope *for reducing* the annual tax on vehicle ownership further.

a) *для уменьшения* b) *уменьшая* c) *уменьшающий*

5. *By decreasing* overall volumes of traffic within the charging zone, and smoothing traffic flows, charging is estimated to be directly responsible for a 12% reduction in emission.

a) *понижив* b) *снижая* c) *снижающийся*

6. Multimodal transport is one of highly effective and modern ways of *facilitating* movement of import and export.

a) *облегчающий* b) *облегчая* c) *облегчения*

Score: 6

Total score: 46

(45 минут)

Intermediate Lexical-Grammar Test 2 (Units 4-6)

**Вариант I**

**I. Выберите правильное определение для каждого данного слова и переведите их на русский язык.**

rush hour, collision, pollution, traffic jam, agent, transport, ticket, infrastructure

1. a person who acts on behalf of another person, group, business, etc.
2. the business or system of transporting goods or people
3. a long line of vehicles on a road that cannot move or can only move very slowly
4. time of day, when the roads, buses, trains are full because people are travelling to or from work
5. a violent impact of moving objects, crash
6. a piece of paper, cardboard, etc., showing that the holder is entitled to certain rights
7. external surroundings in which a plant or animal lives
8. harmful or poisonous substances introduced into an environment

*Score: 8*

**II. Переведите выделенные слова на английский язык.**

1. (Цель) of these policies is to reduce the number of vehicles on the roads and thus reduce (интенсивность движения) during rush hours.
2. The free way is divided into multi-lane highway (с полностью контролируемым доступом).
3. Many countries in the world (ограничивают) the maximum speed on their roads.
4. Road (выбросы транспорта) and fossil consumption in the zone have been reduced.
5. Shifting travel from automobiles to well-utilized public transport can reduce (потребление энергии) and jams on the roads.
6. (Затор) is a daily fact on major roads.
7. The quality of (безопасности) on European roads is low.
8. The quality of (грузоперевозок) and passenger transportation and economic function are affected.

*Score: 9*

**III. Подберите синонимы и переведите их на русский язык.**

License plate, to back, ticket, crash, collision, to support, receipt, number plate, pollution, contamination, hazardous, impact, dangerous, influence.

*Score: 7*

**IV. Переведите на русский язык следующие словосочетания.**

1. limited access road
2. traffic congestion
3. collision avoidance
4. fleet renewal
5. traffic flow
6. engine output
7. carbon content
8. urban mass transport
9. safety aspect
10. traffic density
11. carbon dioxide emissions
12. road signs

*Score: 12*

**V. Подберите соответствующее окончание к началу предложения.**

- |  |                                    |
|--|------------------------------------|
| 1. Most automobile engines operate                                 | a. in polluting the atmosphere     |
| 2. The rapid development of the internal combustion engine led     | b. on the new fuel system.         |
| 3. The fuel is stored  | c. for sporting events             |
| 4. The electric cars will find                                     | d. on the four-stroke cycle .      |
| 5. His report presented some information                           | e. to motor cars in many countries |
| 6. An instrument panel in modern cars provides a driver            | f. to its use in the tractors      |
| 7. It was a period of the application of gasoline engine           | g. in the past twenty years        |
| 8. Motor cycles were found well suited                             | h. with certain information.       |
| 9. Several experimental types of electric cars have been developed | i. a wide application              |
| 10. The increasing amount of combustion engine traffic results     | j. in a fuel tank                  |

*Score: 10*

**VI. Выполните письменный перевод следующего текста.**

Road transport can be the most flexible option for your international business, especially within the European Union. The motorway network is good and crossing national borders is usually quick and efficient.

Other advantages:

- relatively low cost

- extensive road networks - scheduled delivery days and next day delivery services are a viable option
- you can schedule transport to suit you and you can track the location of goods
- consignments can be secure and private

But there are also risks for road transport:

- long distances overland can take more time
- there can be traffic delays and breakdowns
- there is the risk of goods being damaged, especially over long distances
- toll charges are high in some countries
- some countries have different road and traffic regulations

You can either use your own vehicles, or a carrier. If you operate your own vehicles, you will need to consider licences, fuel costs, regulations, driver training and tax.

The international transport of dangerous goods by road is subject to international legislation, in particular the European Agreement on the International Carriage of Dangerous Goods by Road (ADR). Drivers of vehicles carrying dangerous goods must hold an ADR training certificate in handling dangerous goods. All commercial vehicles that carry dangerous goods must pass the ADR test, with some also having to be built to special standards.

*Score: 40*

*Total score: 86*

*(60 минут)*

Intermediate Lexical-Grammar Test 2 (Units 4-6)

**Вариант II**

**I. Выберите правильное определение для каждого данного слова и переведите их на русский язык.**

environment, shortage, collision, pollution, agent, transport, ticket, infrastructure

1. a person who acts on behalf of another person, group, business, government, etc.
2. the business or system of transporting goods or people
3. a violent impact of moving objects, crash
4. a piece of paper, cardboard, etc., showing that the holder is entitled to certain rights
5. a deficiency or lack in the amount needed, expected, or due
6. external surroundings in which a plant or animal lives
7. harmful or poisonous substances introduced into an environment
8. the stock of fixed capital equipment in a country, including factories, roads, schools, etc., considered as a determinant of economic growth

*Score: 8*

**II. Переведите выделенные слова на английский язык.**

1. The (**безопасность**) aspect in transportation is highly (**существенный**) particularly to road transport.
2. Transport is a prime (**источник шума**) and vibration.
3. (**Цель**) of these policies is to reduce the number of vehicles on the roads and thus reduce (**интенсивность движения**) during rush hours.
4. The free way is divided into multi-lane highway (**с полностью контролируемым доступом**).
5. Many countries in the world (**ограничивают**) the maximum speed on their roads.
6. Road (**выбросы транспорта**) and fossil consumption in the zone have been reduced.
7. Shifting travel from automobiles to well-utilized public transport can reduce (**потребление энергии**) and jams on the roads.
8. (**Затор**) is a daily fact on major roads.
9. The quality of (**безопасности**) on European roads is low.
10. The quality of (**грузоперевозок**) and passenger transportation and economic function are affected.

*Score: 12*





vehicle noise emission regulations since 1970s. Technological progress in engines and exhaust systems has made these vehicles considerably quieter.

Besides vehicle engine and exhaust pipes, much of the noise produced by vehicles today, especially in highway operations, results from the movement of vehicles through the air, and the contact of tires with the road. The former can be reduced by aerodynamic vehicle body designs (which also have the effect of improving fuel efficiency and reducing emission). The latter can be reduced through tire design and improvements in pavement surface textures (which also have the effect of reducing the risks of accident).

Transport is a prime source of noise and vibration. These factors grow fast with traffic volume. In certain areas the noise levels hinder normal work and living. Noise is often cited as the main nuisance in urban areas, and traffic noise is the worst offender.

*Score: 40*

*Total score: 86  
(60 минут)*

Intermediate Lexical-Grammar Test 3 (Units 7-9)

**Вариант I**

**I. Выберите правильное определение для каждого данного слова или словосочетания переведите их на русский язык.**

destination, CFR, barcode, CIF, toll, consumer

1. a charge payable to use a bridge or road
2. a term which means the delivery of goods to the named port of destination at the seller's expense and the cargo insurance at the buyer's expense
3. the place to which someone or something is going or being sent
4. a machine-readable code in the form of numbers and a pattern of parallel lines of varying widths, printed on a commodity and used for stock control
5. a term which means the cargo insurance and delivery of goods to the named port of destination at the seller's expense
6. a person who purchases goods and services for personal use

*Score: 6*

**II. Переведите выделенные слова на английский язык.**

1. The main (**цель**) of producers and (**продавцы**), as well as buyers, is to minimize (**затраты**) for (**перевозка**) and logistics and deliver (**товар**) to customers (**в возможно короткие сроки**).
2. Logistics management is that part of the (**цепочки поставок**) which plans, (**осуществляет**) and controls the efficient, effective (**прямой и обратный поток товаров**) between the point of origin and (**пунктом потребления**) in order to meet (**запросы потребителей**).
3. FIATA documents are easily (**отличимые**) as each carries the FIATA (**фирменный знак**) at the head of the page.
4. (**Таможенные**) procedures involve the inspection of the (**груз**) at each national (**граница**) and the imposition of national (**требования безопасности**), guarantee, (**таможенная накладная**), (**депозитная пошлина**), etc. to cover duties and taxes at risk.
5. National controls and procedures applied by (**таможенные власти**) in each country of transit led to (**значительные расходы**), (**задержки**) and (**вмешательство**) with international transport.

*Score: 23*

**III. Подберите синонимы и переведите их на русский язык.**

Adviser, goal, boundary, consultant, carrier, expenses, storehouse, freight, forwarder, aim, warehouse, load, costs, frontier.

*Score: 7*

IV. **Переведите на русский язык следующие словосочетания.**

- 1) customs clearance charge
- 2) freight turnover
- 3) finished goods inventory
- 4) implementation of new technologies
- 5) risk assessment
- 6) a sine qua non
- 7) single transit document
- 8) to submit the issues to the International Chamber of Commerce
- 9) open and fair competition
- 10) Forwarders Certificate of Receipt

Score: 10

V. **Выберите правильный вариант перевода, обращая внимание на перевод инфинитива.**

1. *To overcome such problems, Europe's transport system needs to be optimized* by means of advanced logistics solutions.  
*to overcome a) преодоление b) чтобы преодолеть c) преодолевая to be optimized a) оптимизировать b) для оптимизации c) оптимизируя*
2. One of the things customers expect is *to know* precisely and at all times where their goods are.  
*a) знать b) узнав c) чтобы знать*
3. All imports and exports are reported *to be declared* via the single administrative document.  
*a) чтобы декларировать b) декларация c) декларируют*
4. In 1950 the Customs Cooperation Council (now the WCO) was established *to secure* "the highest degree of harmony and uniformity in customs systems."  
*a) чтобы обеспечить b) обеспечивая c) чтобы обезопасить*
5. *To be* successful, logistics companies must provide prompt pickup, excellent customer service, and fast, accurate, damage-free delivery.  
*a) будучи успешными b) быть успешными c) для того, чтобы быть успешными*

Score: 6

Total score: 52

(45 минут)

Intermediate Lexical-Grammar Test 3 (Units 7-9)

**Вариант II**

**I. Выберите правильное определение для каждого данного слова или словосочетания переведите их на русский язык.**

seal, inventory, consumer, carnet, producer, destination

1. a complete list of items such as property, goods in stock
2. something such as a piece of sticky paper or wax that is fixed to a container or door and must be broken before the container or door can be opened
3. a customs permit allowing a motor vehicle to be taken across a frontier for a limited period
4. a person who purchases goods and services for personal use
5. a person, company, or country that makes, grows, or supplies goods or commodities for sale
6. the place to which someone or something is going or being sent

*Score: 6*

**II. Переведите выделенные слова на английский язык.**

1. (Логистическая цепочка) can be defined as having the (соответствующий предмет) in the (соответствующем количестве) at the (соответствующее время) at the (соответствующем месте) for the (соответствующую цену) and is the science of process and incorporates all industry sectors.
2. Logistics management is that part of the (цепочки поставок) which plans, (осуществляет) and controls the efficient, effective (прямой и обратный поток товаров) between the (пункт происхождения) and (пунктом потребления) in order to meet (запросы потребителей).
3. Two operations could be run (одновременно) that seems to be extremely (выгодно) for sellers.
4. (Что касается) Customs control measures (на границе), the TIR system (избегает) the need for physical inspection in countries of transit other than (проверка пломб) and the (внешних) conditions of the (грузовой вагон) or container.
5. Customs authorities can (уменьшить) routine administrative (таможенные процедуры) and (посвятить) their resources to specific control measures based on (оценке риска) and intelligence information.

*Score: 24*

**III. Подберите синонимы и переведите их на русский язык.**

Goal, implementation, duty, transaction, objective, freight dispatcher, benefit, logo, expediter, realization, advantage, trade mark, deal, customs.

*Score: 7*

**IV. Переведите на русский язык следующие словосочетания.**

- 1) border crossing procedures
- 2) liability insurance
- 3) per procurationem
- 4) load compartment
- 5) the geographical repositioning of raw materials
- 6) electronic data interchange
- 7) replenishment of inventories
- 8) freight revenue
- 9) Forwarders Certificate of Transport
- 10) customs import value

*Score: 10*

**V. Выберите правильный вариант перевода, обращая внимание на перевод инфинитива.**

1. The vast majority of companies consider customer service *to be* an important aspect of their business.  
*a) является b) будучи c) чтобы быть*
2. The primary purpose of the ICC is *to promote* trade and investment and encourage the free flow of capital.  
*a) содействие b) содействуя c) чтобы содействовать*
3. *To ensure* that the supply chain is operating as efficient as possible, companies have adopted Supply Chain Management processes.  
*a) обеспечить b) для того, чтобы обеспечить c) будучи застрахованными*
4. “Paperless” declarations are expected *to arrive* in the near future.  
*a) появятся b) чтобы появиться c) для появления*
5. Forwarding agents are used by exporters *to arrange* both import and export shipments.  
*a) организуют b) для организации c) организуя*

*Score: 5*

*Total score: 52*

*(45 минут)*

Intermediate Lexical-Grammar Test 4 (Units 10-12)

**Вариант I**

**I. Выберите правильное определение для каждого данного слова или словосочетания переведите их на русский язык.**

Intermodal, pallet, demand, distribution, barrel, perishables

1. a flat wooden or metal platform on which goods are stored so that they can be lifted and moved using a forklift truck
2. things, especially foodstuffs, likely to decay or go bad quickly
3. a slatted wooden case used for transporting goods
4. involving two or more different modes of transport in conveying goods
5. the action of sharing something out among a number of recipients
6. willingness and ability to purchase goods and services

*Score: 6*

**II. Переведите выделенные слова на английский язык.**

1. New types of problems, **such as a significant (рост потребления топлива), (увеличение ущерба окружающей среде), traffic congestion and a (увеличение ДТП) have emerged.**
2. Container **(объём)** is often expressed in **(единицах, эквивалентных 20 футам) (TEU).**
3. **(Бортовой компьютер)** monitors vehicle and **(поведение водителя) - vehicle speed, engine (время простоя), (расстояние), driver's (стиль вождения).**
4. The **(введение)** of electronic **(водительских прав)** could also help with the enforcement of **(штрафов)**, such as the **(потеря подвижности)** of vehicles whose drivers have lost their licenses.
5. Information technology innovations **(требуют)** the electronic **(обмен данных)** and information concerning **(груз)**, vehicle location, current **(условий движения)**, optimal **(схемы движения груза).**

*Score: 19*

**III. Подберите синонимы и переведите их на русский язык.**

Shipping, accident, swap body, consumption, costs, use, expenses, occupant, punishment, transportation, removable truck body, penalty, crash, passenger.

*Score: 7*

**IV. Переведите на русский язык следующие словосочетания.**

1. container handling equipment
2. bulk supply

3. carrying capacity
4. maintenance costs
5. demand forecast data
6. door-to-door delivery system
7. raw material inventory stock level
8. container depot
9. onboard driving aids
10. Intermodal Transport Units
11. to smuggle contraband
12. removable truck body

Score: 12

**V. Выберите правильный вариант перевода, обращая внимание на перевод герундия и причастия.**

1. Wireless mobile communications equipment is becoming more and more common *for linking* drivers with the warehouse as well as the dispatcher.  
a) связав b) для связи c) связывающий
2. A transit duty, or transit tax, is a tax *levied* on commodities *passing* through a Customs area en route to another country.  
*levied* a) взимаемый b) взимался c) взимать  
*passing* a) проходят b) снижая c) при прохождении
3. It is worth *mentioning* that infrastructure impacts the efficiency with which transportation systems operate.  
a) упомянуть b) упоминая c) упомянув
4. Supplies *received* should be checked as soon as possible upon receipt.  
a) получая b) полученные c) получили
5. By *reducing* supply-chain costs, Procter and Gamble is achieving higher profits.  
a) снизив b) снижая c) после того, как снизили

Score: 6

**VI. Выполните письменный перевод следующего текста.**

To be successful, logistics companies must provide prompt pickup, excellent customer service, and fast, accurate, damage-free delivery. Information technology helps to shorten cycle times and speed shipments through every phase of the logistics process. For this reason, information has become as important to the supply chain as cargo.

When a driver accepts a shipment, he checks it against a paper bill of lading which contains a bar code printed by the shippers. Using a hand-held computer in his truck cab, the driver scans the bill into the computer, which then transmits the information over a radio network to a central computer. These radio transmissions keep the database of the central computer constantly updated. With this information, the transport manager knows at all times which goods have been



picked up and delivered, and where, and whether extra people or vehicles will be needed to handle the flow. Access to the central database also enables drivers to inform customers of the status of their goods, and allows them to instantly transmit rescheduling requests to the dispatcher.

In the warehouse, dock management systems deliver information to every member of the warehouse team through bar code scanning and radio frequency terminals. Packages are scanned and the information is used to update the package status in the central database so that transport managers in the office know where packages are at all times.

*Score: 50*

*Total score: 100*

*(60 минут)*

Intermediate Lexical-Grammar Test 4 (Units 10-12)

**Вариант II**

- I. **Выберите правильное определение для каждого данного слова или словосочетания переведите их на русский язык.**

driving license, telematics, crate, goods, barrel, bale

1. the branch of science concerned with the use of technological devices to transmit information over long distances
2. a large wrapped or bound bundle of paper, hay, or cotton
3. a cylindrical container bulging out in the middle, traditionally made of wooden staves with metal hoops round them
4. a slatted wooden case used for transporting goods
5. an official document or certificate authorizing a person to drive a motor vehicle
6. commodities that are tangible, usually movable, and generally not consumed at the same time as they are produced

*Score: 6*

- II. **Переведите выделенные слова на английский язык.**

1. The introduction of containers resulted in vast improvements in (эффективность обработки грузов в порту), thus lowering costs and helping lower (расходы по перевозке) and, in turn, (поддержка торговых потоков).
2. (Учитывая) the tare mass of the container, the maximum (полезная нагрузка) mass is therefore (уменьшены).
3. (Бортовой компьютер) monitors vehicle and (поведение водителя) - vehicle speed, engine (время простоя), (расстояние), driver's (стиль вождения).
4. (Дорожные перевозки) is the mode that has (расширен) the most over the last 50 years, both for passengers and (грузоперевозки).
5. Technological innovation (обеспечивает) an excellent (возможность) to integrate the (виды транспорта), make them safer and help make the European transport system (совместимой) with (устойчивое) transport development.

*Score: 19*

- III. **Подберите синонимы и переведите их на русский язык.**

Seat belt, benefit, income, reduction, truck, restriction, lessening, lorry, safety belt, limitation, revenue, advantage, passenger, occupant.

*Score: 7*

**IV. Переведите на русский язык следующие словосочетания.**

1. International Organization for Standardization
2. to smuggle contraband
3. open side for loading
4. removable truck body
5. carrying capacity
6. multi-lane urban expressway
7. external costs
8. electronic funds transfer
9. hydrogen fuel cells
10. smart protection device
11. semi-finished goods
12. supply chain business process integration

Score: 12

**V. Выберите правильный вариант перевода, обращая внимание на перевод герундия и причастия.**

1. Customs officers are responsible *for ensuring* that *imported* and exported goods are properly identified, and seized *if stolen* or smuggled.  
*for ensuring* a) *обеспечивающие* b) *за обеспечение* c) *обеспечив*  
*imported* a) *импортируемые* b) *импортировали* c) *для импорта*  
*if stolen* a) *украли ли* b) *украсть* c) *в случае кражи*
2. Some parcels must bear special signs *indicating* their contents.  
a) *чтобы указывать* b) *указывая* c) *указывающие*
3. *Using* the Internet reduces data input, eliminates paper work, faxes and phone calls, and improves customer service.  
a) *используя* b) *использование* c) *использованный*
4. The level of any fine *imposed* will vary depending on the degree of the offence involved.  
a) *наложенного* b) *накладывает* c) *при наложении*

Score: 6

**VI. Выполните письменный перевод следующего текста.**

The Internet has had a major effect on logistics and its influence is likely to increase in the future. Supply chain management is now largely a matter of electronic business-to-consumer (B2C)<sup>1</sup> and business-to-business (B2B)<sup>2</sup> commerce. This has increased pressure on companies to deliver their product in real time, and really quickly.

In other words, easy access to information means an increase in customer expectations. One of the things customers expect is to know precisely and at all times where their goods are, which is possible through real time tracking systems that customers can access on-line. They also have increased delivery time

expectations; a customer is not as willing to wait two weeks for something it took five minutes to order on-line.

E-commerce helps companies to meet these expectations. Using the Internet reduces data input, eliminates paper work, faxes and phone calls, and improves customer service and the speed and accuracy of delivery.

This is particularly true for global supply chain management. Imagine that a key part, which is needed for a shipment going out the next day, breaks in production and there are no more in the plant.

Traditionally, in that situation, a plant worker would complete a purchasing requisition form, a supervisor would approve it, and a purchasing clerk would complete and place the order. When it arrived, a receiver would accept and record it, and a stock clerk would put it in inventory.

<sup>1</sup> взаимодействие "бизнес для потребителя"

<sup>2</sup> взаимодействие "бизнес для бизнеса"

*Score: 50*

*Total score: 100*

*(60 минут)*

Intermediate Lexical-Grammar Test 1 (Unit 1 – Unit 5)

Variant 1

I. Complete the sentences (1-6) with the words below (a-f).

- a) catch
- b) speak to
- c) get through
- d) calling about
- e) repeat
- f) returning

1. **Could I ..... Bob Little, please?**
2. **Listen, Steve, I'm actually trying to ..... to Paula.** Is she there at the moment?
3. I'm ..... our meeting tomorrow.
4. Sorry, I didn't .... your name.
5. Could you ..... that, please?
6. I'm just ..... your call from yesterday.

Score 6

II. Do these pairs of sentences mean the same thing or something different? Write S (same) or D (different).

1. Speak up, please. / Speak more loudly, please. ( )
2. **I didn't catch that.** / **I couldn't hear that.** ( )
3. Spell the name of your company. / Repeat the name of your company. ( )
4. **I'll ring you back.** / **I'll call you back.** ( )

Score 4

III. Rewrite the sentences below to make them more polite.

1. Send us a corrected invoice.
2. What do you want to know?
3. What is your name again?
4. Speak loudly.

Score 4

IV. Choose the correct variant to complete these sentences.

1. A swap body is .....  
(a) an empty container.

- (b) a tool to load and unload containers.
- (c) a type of container that can easily be transferred from one means to another.
- (d) tool to secure cargo during transportation.

2. **Perishable cargo can be defined as.....**

- (a) goods that will deteriorate over a given period of time, or if exposed to extreme temperatures (heat or cold), humidity or other environmental conditions.
- (b) goods that are transported by planes.
- (c) any goods, including articles and substances which may pose a danger to the health and safety of people, or damage to property or the environment during carriage.
- (d) large items of specific equipment.

3. **Fragile goods must be handled with .....**

- (a) respect.
- (b) love.
- (c) care.
- (d) sympathy.

4. **A tarpaulin is a .....**

- (a) a type of coat without sleeves, made from one large piece of cloth with a hole in the middle for the head to go through.
- (b) a large cover, often made of wool, used especially on beds to keep people warm.
- (c) a large sheet made of heavy waterproof material, used to cover things with and to keep rain off.
- (d) a piece of cloth or paper used for drying things, especially your body.

Score 4

V. Complete the sentences with prepositions.

1. **The customs authority may be different .....** the immigration authority.
2. **Tax is also often paid .....** goods and services.
3. **Any goods coming .....** and going ..... **of a country have to go through** certain government control procedure and formalities.
4. **We can go through the rest of the consignment details .....** the phone.
5. Governments use and rely ..... the customs service to control the physical movement of goods.

Score 5

VI. Match the words (1-5) with their definitions (a-e) below.

1. customs broker
  2. consignor
  3. bonded warehouse
  4. customs clearance
  5. certificate of origin
- 
- a. a government building where imported goods are stored until tax has been paid on them
  - b. the act of passing goods through customs so that they can enter or leave the country
  - c. an official document that states where a food or product was produced, and by which company
  - d. a person or company that is paid to make sure that all necessary taxes are paid and rules are followed so that goods can be imported into a country
  - e. a person or company that sends goods to someone

Score 5

Total Score 28 (100%)

Intermediate Lexical-Grammar Test 1 (Unit 1 – Unit 5)

Variant 2

I. Complete the sentences (1-6) with the words below (a-f).

- a) speak up
- b) put me through
- c) engaged
- d) read that back
- e) call you back
- f) follow

1. **Sorry, I'm really busy at the moment. Can I ..... later today?**
2. **Could you ..... to your accounts department, please?**
3. **Let me just ..... to you.**
4. Sorry, I can't hear you. Can you ..... a bit, please?
5. I'm afraid his/her line is .....
6. **I'm afraid I don't ..... you. Could you repeat it, please?**

Score 6

II. Do these pairs of sentences mean the same thing or something different? Write S (same) or D (different).

1. Speak more slowly, please. / Please hold on a moment. ( )
2. Can you read that back to me? / Can you take a message? ( )
3. **Let me read that back to you.** / **Let me just check I've got that.** ( )
4. **I'm calling about the truck options described on your website.** / **I'd like to ask about the truck options described on your website.** ( )

Score 4

III. Rewrite the sentences below to make them more polite.

1. What is your question?
2. Send us a corrected invoice.
3. I just want to check the address.
4. Who are you?

Score 4

IV. Choose the correct variant to complete these sentences.

1. A semitrailer is a .....



- (a) a large road vehicle that carries passengers, especially one that travels along a fixed route and stops regularly to let people get on and off.
- (b) a vehicle for carrying earth, stones, etc. in a container which can be lifted up for the load to fall out.
- (c) a large ship or boat.
- (d) a trailer that has wheels at the back and is supported at the front by the vehicle that is pulling it.

2. **A tarpaulin is a .....**

- (a) a type of coat without sleeves, made from one large piece of cloth with a hole in the middle for the head to go through.
- (b) a large cover, often made of wool, used especially on beds to keep people warm.
- (c) a large sheet made of heavy waterproof material, used to cover things with and to keep rain off.
- (d) a piece of cloth or paper used for drying things, especially your body.

3. **Perishable cargo can be defined as.....**

- (a) goods that will deteriorate over a given period of time, or if exposed to extreme temperatures (heat or cold), humidity or other environmental conditions.
- (b) goods that are transported by planes.
- (c) any goods, including articles and substances which may pose a danger to the health and safety of people, or damage to property or the environment during carriage.
- (d) large items of specific equipment.

4. **Customs is.....**

- (a) an accepted way of behaving or of doing things in a society or a community.
- (b) the government department that collects taxes on goods bought and sold and on goods brought into the country, and that checks what is brought in.
- (c) an institution at the highest level of education where you can study for a degree or do research.
- (d) a tax that is paid on goods coming into or going out of a country.

Score 4

V. Complete the sentences with prepositions.

1. **Commercial goods not yet cleared** ..... **customs are held in** a customs area, often called a bonded store, until processed.
2. **Have you come** .....**any conclusion?**
3. **Speed of clearance depends largely** ..... **what controls are required by** legislation and the degree to which information and communication technology is applied.
4. **The units should be picked** ..... **on August 9<sup>th</sup>.**
5. **I'll fill** .... **the quotation for you.**

Score 5

VI. Match the words (1-5) with their definitions (a-e) below.

1. customs officer
  2. export license
  3. customs broker
  4. consignor
  5. bonded warehouse
- 
- a) a place where goods are kept before tax is paid on them
  - b) a person or company that sends goods to someone
  - c) an official document that gives you permission to send something out of the country for sale
  - d) a person or company that is paid to make sure that all necessary taxes are paid and rules are followed so that goods can be imported into a country
  - e) a government official whose job is to check that goods leaving or entering a country are legal

Score 5

Total score 28 (100%)

## Intermediate Lexical-Grammar Test 2 (Unit 6 – Unit 8)

### Variant 1

I. Complete the sentences (1-6) with the words below (a-f).

- a. see to
- b. get back
- c. get in touch
- d. look into
- e. find out
- f. **sort...out**

1. I'll ..... to you as soon as I've spoken to the forwarder.
2. If you can wait a moment, I'll ..... it all ..... for you.
3. Mrs Chapman asked for some help with the orders - **could you ..... it?**
4. I'll ..... the possibility of merging the two departments.
5. I'm trying to ..... with Jane. Do you have her number?
6. **Can you ..... what time the meeting starts?**

Score 12

II.

III. Match the phrases (a-f) with their definitions (1-6) below.

- a) sort something out
- b) find out
- c) get in touch with somebody
- d) look into
- e) see to something/somebody
- f) get back to somebody

1. to deal in a satisfactory or successful way with a problem or situation
2. to speak or write to somebody again later, especially in order to give a reply  
to deal with
3. to do something that has to be done
4. to communicate with somebody, especially by writing to them or telephoning  
them
5. to examine something
6. to get information about something because you want to know more about it,  
or to learn a fact or piece of information for the first time

Score 12

IV. Choose the correct variant to complete these sentences.

1. **Dangerous Goods are .....**

- a) machines and tools used in the production of other goods.
- b) consumable goods such as unhealthy food and beverages, tobacco and alcohol, cleaning products.
- c) any goods, including articles and substances which may pose a danger to the health and safety of people, or damage to property or the environment during carriage.

2. **Freight forwarders .....**

- a) test both hard and software systems, and diagnose and resolve system faults.
- b) plan, design and oversee construction and maintenance of building structures and facilities, such as roads, railways, airports, bridges, power plants, water and sewage systems.
- c) oversee the worldwide movement of cargo, packing, documentation and customs clearance, on behalf of importers and exporters.

3. **CTU means.....**

- a) a freight container, swap-body, vehicle, railway wagon or any other similar unit.
- b) a docking, unloading and loading area.
- c) materials that are radioactive, flammable, explosive and corrosive.

4. **HGV is .....**

- a) a light motor vehicle with an open-top, rear cargo area (bed).
- b) a ship used for transporting passengers.
- c) a large road vehicle used for moving goods.

Score 8

V. Match the beginnings (1-6) of the sentences with the endings (a-f).

- 1. **Turn .....**
- 2. **Take .....**
- 3. **Go straight .....**
- 4. **Go .....**
- 5. **Head .....**
- 6. **Walk up .....**

- a) noth.
- b) on at the major traffic lights.
- c) this street.
- d) through the tunnel.
- e) the first road on the left.
- f) left at the lights.

Score 6

VI. Complete the sentences with prepositions.

- 1. Secure the cargo..... the trailer using straps and chains.
- 2. I have to deal .... all the necessary documentation.
- 3. I am also responsible ..... financial aspects.
- 4. My job is to organize the transport of goods either ....sea, air, road or rail.
- 5. It's .... Oxford Street.

Score 5

VII. Match the words (1-7) with their definition (a-g) below.

- 1. packaging
- 2. carrier
- 3. freight
- 4. freight forwarder
- 5. stack
- 6. trailer
- 7. delivery

- a) goods that are transported by ship, aircraft, train, or truck
- b) the rear section of an articulated lorry
- c) the act of taking goods, letters, etc. to the people they have been sent to
- d) a pile of things arranged one on top of another
- e) a company that arranges for goods to be transported, especially to another country
- f) the materials in which objects are wrapped before being sold
- g) a company that transports goods or people from one place to another

Score 7

Total score 50 (100%)

Intermediate Lexical-Grammar Test 2 (Unit 6 – Unit 8)

Variant 2

I. Complete the sentences (1-6) with the words below (a-f).

- a) see to
- b) get back
- c) get in touch
- d) look into
- e) found out
- f) sort out

1. **I'll find out and ..... to you.**
2. **Her financial records are a mess, but we'll ..... them .....**
3. **These letters need posting." "I'll ..... them later."**
4. **I'll ..... the reasons for the decision.**
5. **Do you ..... with any of your old school friends?**
6. **I haven't ..... anything about him yet.**

Score 12

II. Match the phrases (a-f) with their definitions (1-6) below.

- a) see to something/somebody
- b) find out
- c) get in touch with somebody
- d) look into
- e) sort something out
- f) get back to somebody

- 1 to deal in a satisfactory or successful way with a problem or situation
- 2 to speak or write to somebody again later, especially in order to give a reply  
to deal with
- 3 to do something that has to be done
- 4 to communicate with somebody, especially by writing to them or telephoning  
them
- 5 to examine something
- 6 to get information about something because you want to know more about it,  
or to learn a fact or piece of information for the first time

Score 12

III. Choose the correct variant to complete these sentences.

1. Dangerous goods **are** .....
  - a) nonrenewable organic materials.
  - b) solids, liquids, or gases that can harm people, other living organisms, property, or the environment.
  - c) goods that are ready for consumption in satisfaction of human wants.
  
2. **Freight forwarders** .....
  - a) design and build tall buildings and large structures.
  - b) specialise in moving cargo, they also arrange customs clearance of goods, maintain all documentation, oversee cargo packing and will at times deal with the movement of dangerous goods.
  - c) assist customers with their day-to-day transactions such as deposits, withdrawals and loan payments.
  
3. **CTU means**.....
  - a) explosive materials.
  - b) a loading area.
  - c) a freight container.
  
4. **HGV is** .....
  - a) a large truck used for transporting goods.
  - b) a road vehicle used for transporting people.
  - c) a place where vehicles can be repaired.

Score 8

IV. Match the beginnings (1-6) of the sentences with the endings (a-f).

1. **Get on/off** .....
  2. **Go** .....
  3. **Follow** .....
  4. **Go over** .....
  5. **Take** .....
  6. **Keep** .....
- 
- a) the motorway.
  - b) the railway lines.
  - c) going along there.
  - d) the third exit at the roundabout.
  - e) down to the end of the road.
  - f) the signs.

Score 6

V. Complete the sentences with prepositions.

1. Our customer in London has just **informed me that they are .....of stock and** need an urgent delivery.
2. **I arrange customs clearance .... behalf of my clients.**
3. **Another part of my job is to liaise .... departments such as transport and** production.
4. **It's ..... the corner of** Regent Street and Piccadilly.
5. **I'm really sorry .... this.**

Score 5

VI. Match the words (1-7) with their definition (a-g) below.

1. shiftwork
2. fragile
3. consignee
4. crate
5. procurement
6. consignment
7. haulage contractor

- a) an large box made of wood, plastic, or metal, used for storing or transporting things
- b) the process by which an organization buys the products or services it needs from other organizations
- c) a person or company whose business is transporting goods for others by road or railway
- d) a system in which groups of employees work for different agreed periods during the day and night
- e) the person or company to whom goods or documents are officially sent or delivered
- f) a quantity of goods that are sent or delivered somewhere
- g) easily broken or damaged

Score 7

Total score 50 (100%)



## Intermediate Lexical-Grammar Test 1 (Part 1)

Time: 90 min

1. Match each word in column A with its meaning in column B

A	B
1. THIS SIDE UP	A. Хранить вдали от нагревательных приборов
2. FRAGILE	B. Беречь от влаги (боится сырости)
3. STOW AWAY FROM HEAT	C. Не бросать!
4. USE NO HOOKS	D. Верх здесь!
5. TO BE KEPT COOL	E. Поднимать здесь
6. DO NOT DROP	F. Открывать здесь
7. GLASS – WITH CARE	G. Скоропортящийся продукт
8. PERISHABLE	H. Хранить в прохладном месте
9. TOP	I. Не складировать на палубе
10. KEEP DRY	J. Осторожно!
11. ACID – WITH CARE	K. Не пользоваться крюками
12. OPEN THIS END	L. Осторожно, кислота!
13. DO NOT STOW ON DECK	M. Огнеопасно!
14. INFLAMMABLE	N. Верх!
15. LIFT HERE	O. Осторожно! (Хрупкий груз!)
16. HANDLE WITH CARE	P. Осторожно, стекло!

16 points

2. Choose the right continuation of each sentence.

<p>1. A transit permit shall be valid for one round trip transit <b>journey...</b></p>	<p><b>a. ... to facilitate, simplify and</b> accelerate the customs and other formalities relating to carriage of passengers and goods.</p>
<p>2. It shall also be valid for one vehicle and only for the carrier <b>to whom...</b></p>	<p><b>b. ... unless either Contracting</b> Party expresses its wish in writing to the other Contracting Party to terminate it at least three months prior to the date of expiry.</p>
<p>3. Arms, ammunitions and military equipment and explosives are excluded from <b>the right of transit unless ...</b></p>	<p><b>c. ... through the territory of the</b> Contracting Parties</p>
<p>4. The Contracting Parties shall <b>take all the measures in order...</b></p>	<p><b>d. ... the</b> Convention on the International Transport of Goods undercover of TIR Carnets and/or national laws and regulations.</p>
<p>5. An unloaded vehicle registered in one Contracting <b>Party shall not enter...</b></p>	<p><b>e. ... any kind of insurance</b> complying with the laws and regulations.</p>
<p>6. The transit tourist carriage and shuttle service to be performed by a vehicle registered in the territory of one Contracting Party to or from the territory of the other <b>Contracting Party...</b></p>	<p><b>f. ... the other Contracting Party</b> with reports and results of the inquiry and other necessary information.</p>
<p>7. The International transport of goods by road in accordance with this Agreement shall be <b>subject to the requirements of...</b></p>	<p><b>g. ... it is issued and shall not</b> be transferable.</p>

8. Fuel contained in the standard tanks of vehicles shall <b>be exempt from...</b>	<b>h. ... the territory of the other</b> Contracting Party to collect passengers and goods unless permit is issued for this purpose.
9. All carriages to be performed in accordance with this Agreement shall be covered <b>by...</b>	<b>i. ... laws and regulations</b> governing the road traffic of the other Contracting Party.
10. In cases of accidents, breakdowns or other difficulties, the competent authorities of the Contracting Party in whose territory such an incident occurs, <b>shall provide...</b>	<b>j. ... a permit is obtained from</b> the Contracting Parties.
11. Carriers and crew of the vehicles registered in one Contracting Party shall comply <b>with...</b>	<b>k. .... customs duties and all</b> other taxes and duties. The standard tank is of vehicles.
12. This Agreement shall be automatically renewed for <b>period of one year...</b>	<b>l. ... shall not be subject to</b> obtaining permit.

12 points

*3. Fill in the gaps with the appropriate words and word combinations from the box. Translate the sentences into Russian.*

agreement, cargo damage, contemplated, the terms, damage, property, penalties, responsible for, chargebacks, deliveries, to notify, liable for, indemnify, breakdown, delays, warrants, proprietary information, bill of lading, claims, liabilities, suits, the terms, the provisions, divulge, stipulate, governmental regulations,

insurance policies, cover, invoice, receipt, remit, provision

1. Carrier represents and \_\_\_\_\_ that it does not have a conditional or unsatisfactory safety rating, and agrees to comply with all federal, state, and local laws regarding the \_\_\_\_\_ of the transportation services \_\_\_\_\_ under this Agreement.
2. Carrier agrees that it will not \_\_\_\_\_ to any third party \_\_\_\_\_ of this Agreement, or any \_\_\_\_\_ derived in the course of performance of this Agreement.
3. CARRIER shall be \_\_\_\_\_ any loss, \_\_\_\_\_ or destruction of any \_\_\_\_\_ transported under this Agreement.
4. CARRIER shall \_\_\_\_\_ and hold harmless SHIPPER and PROPAK from and against any and all \_\_\_\_\_, demands, direct or indirect damages, causes of action, \_\_\_\_\_, losses, \_\_\_\_\_, taxes, \_\_\_\_\_ and fines from any source.
5. In the event there is a conflict between \_\_\_\_\_ of this Agreement and the bill of lading, \_\_\_\_\_ of this Agreement shall govern.
6. PROPAK and CARRIER hereby mutually agree and \_\_\_\_\_ that each is familiar with all \_\_\_\_\_, that each will fully comply with said regulations.
7. CARRIER shall maintain \_\_\_\_\_ in force at all times that \_\_\_\_\_ personal liability, property damage and \_\_\_\_\_, as well as all coverage required under applicable state and/or federal law.
8. CARRIER must provide a completed invoice together with all of the signed original \_\_\_\_\_, signed pickup receipts and signed proof of delivery receipt for each shipment included on the \_\_\_\_\_.
9. PROPAK shall \_\_\_\_\_ payment to CARRIER for each load within 30 days of \_\_\_\_\_ by PROPAK of all properly executed paperwork for the load.

29 points

4. Here are some useful phrases connected with the transportation insurance. Match them with their Russian equivalents.

1. The buyer (seller) bears the risk for the transport of the goods.	a. За время перевозок товары застрахованы от утери и /или повреждения.
2. During transportation the goods are insured against loss and / or damage.	b. Если Вы потребуе, мы застрахуем данные товары за Ваш счёт.
3. The risk of loss or damage will be carried by us (you).	c. Транспортная страховка может быть заключена за Ваш счёт
4. The goods are insured while in transit.	d. До прибытия в место назначения товары застрахованы от утери или повреждения.
5. We insure the goods at our (your) cost against damage in transport.	e. Покупатель (продавец) несёт риск, связанный с транспортировкой товара
6. We (you) pay the transport insurance.	f. Стоимость страховки (не)включена в цену наших товаров.
7. The goods are insured	g. Мы застрахуем товары от

against loss or damage until they arrive at destination.	повреждения в пути за наш (Ваш) счёт.
8. Cost of insurance is split equally between customer and seller.	h. Транспортная страховка оплачивается нами (Вами).
9. According to your request we took out a transportation insurance policy and will charge same to you.	i. Стоимость страховки делится поровну между продавцом и покупателем.
10. Should you so desire, we shall insure these goods at your cost.	j. Риски, связанные с утерей и повреждениями, несём мы (несёте Вы).
11. A transport insurance can be taken out, the cost of which we will charge to you.	к. Товары застрахованы на время пребывания в транзите.
12. Cost of insurance is (not) included in our price of goods.	l. Соответственно Вашим требованиям, мы заключили страховку по перевозке и расходы перекладываем на Вас.

12 points

5. Fill in the gaps with the necessary prepositions.

1. \_\_\_\_\_ time to time, shipments \_\_\_\_\_ property provided \_\_\_\_\_ PROPAK'S customers require the services of a motor carrier \_\_\_\_\_ the purpose of transporting commodities \_\_\_\_\_ points in the continental United States.

2. CARRIER agrees that it will use only tractors, trailers and other equipment which are \_\_\_\_\_ good condition and are clean, sound and free \_\_\_\_\_ odors, moisture and other conditions that might result \_\_\_\_\_ loss or damage to or adverse effect \_\_\_\_\_ the goods transported.

3. PROPAK is responsible \_\_\_\_\_ all payments \_\_\_\_\_ CARRIER \_\_\_\_\_ all services rendered \_\_\_\_\_ the CARRIER.

4. CARRIER specifically agrees that it shall not reveal the terms \_\_\_\_\_ which it provides transportation \_\_\_\_\_ any third party represented \_\_\_\_\_ PROPAK.

5. CARRIER shall be liable \_\_\_\_\_ any loss, damage or destruction \_\_\_\_\_ any property transported \_\_\_\_\_ this Agreement.

6. \_\_\_\_\_ the event there is a conflict \_\_\_\_\_ the terms \_\_\_\_\_ this Agreement and the bill \_\_\_\_\_ lading, the provisions \_\_\_\_\_ this Agreement shall govern.

7. This Agreement constitutes the entire Agreement \_\_\_\_\_ the CARRIER and PROPAK \_\_\_\_\_ respect to the subject matter \_\_\_\_\_ this Agreement and may not be modified or amended unless accomplished \_\_\_\_\_ writing, signed \_\_\_\_\_ both CARRIER and PROPAK.

8. CARRIER agrees that it will be responsible \_\_\_\_\_ any SHIPPER or customer chargebacks resulting \_\_\_\_\_ late deliveries or missed appointments

31 points

Total Score: 100 points

## Intermediate Lexical-Grammar Test 2 (Part 2)

Time: 90 min

1. Match a word or word combination in column A with its meaning in column B.

A	B
1. freight forwarder	a) рабочая сила
2. curriculum vitae	b) колебаться, не решаться
3. freight movement	c) заработная плата
4. preliminary	d) двуязычный
5. manpower	e) время работы
6. departmental head	f) участие
7. staff	g) частичная потеря
8. vehicle damage	h) фраговая отправка
9. valuer	i) автобиография
10. working hours	j) начальник отдела
11. part-loss	k) предварительный
12. participation	l) оценщик
13. to be responsible for	m) персонал
14. salary	n) проблема, вопрос
15. to look into the matter	o) страховое покрытие
16. case	p) быть ответственным за
17. bilingual	q) оценивать
18. insurance cover	r) рассмотреть вопрос
19. to hesitate	s) транспортный ущерб
20. to assess	t) экспедитор

20 points

2. Choose the appropriate English words or word combinations found in Letters 21-23 for the Russian variants given in brackets:

opportunity, employer, do not hesitate, enclose, as stipulated,  
freight movements, available, due to personal reasons, well-run, at

your earliest convenience, advertisement, accommodation expenses, challenge, asset, performance-related salary, division, preliminary, previous experience, department, team, with reference to, responsible, in excess of, referees, suitable, notified, curriculum vitae, short-listed candidates, contribute, currently, enclosed, improvement, employers, further

1. I am writing in reply to your (объявление) in the European News for the post of Sales Manager in your European (отдел).
2. I (прилагаю) a full (резюме, краткая биография) and the names of two (поручители) (как требуется).
3. My current (зарплата в зависимости от достижений) is (свыше) £ 30K p.a.
4. I look forward to your reply (как можно скорей).
5. I have held this post for three years now and would welcome an (возможность) to work in Britain.
6. I am (в настоящее время) employed as Freight Coordinator and I am (ответственный) for (перевозка грузов) to and from the US and Britain.
7. We are inviting (подходящий) candidates to attend for a (предварительное) interview on the Saturday.
8. All (кандидаты, прошедшие первичный отбор) will be (извещены) approximately 10 days after interview.
9. We (не колеблясь) to recommend her to any future (наниматель).
10. (Касательно) your advertisement I should like to apply for the job of Supplies manager.
11. (По личным причинам), I have to move to London within the next month.
12. I think my (предыдущий опыт) will be an (ценное качество) and that I could (вносить вклад) significantly to your (команда).
13. References are (имеются в наличии) from my present and previous (работодатели).
14. Please find (в приложении) a copy of my CV for your (дальнейшей) information.
15. I have always enjoyed the (вызов, проблема) of a (хорошо организованный) supplies (отдел) and the constant need for (улучшение) and value analysis.

33 points

3. Choose the best alternative to complete the sentences.

1. The bookkeeper keeps a record of every financial \_\_\_\_\_ .  
a) action      b) transaction      c) entry      d) transcription
2. It's essential to \_\_\_\_\_ the invoice number in any correspondence.  
a) estimate      b) quote      c) say      d) tell
3. This company has a weekly \_\_\_\_\_ of about \$100,000.  
a) pay      b) turnover      c) salary      d) wage
4. Check the \_\_\_\_\_ note and see that you've got everything.  
a) deliver      b) delivered      c) delivery      d) delivering
5. I've just received an \_\_\_\_\_ note telling me that the goods have been dispatched.  
a) advice      b) advise      c) invoice      d) advisory
6. The task of the public relations department is to project the right \_\_\_\_\_ of a company.  
a) painting      b) image      c) picture      d) drawing
7. Because of high shipping costs, it made more sense to \_\_\_\_\_ a manufacturer to produce our range of furniture.  
a) license      b) lease      c) control      d) handle
8. The government has imposed protective traffic to stop the \_\_\_\_\_ of cheap imports when threatened to destroy domestic industries.

- a)rain            b)famine            c)flood            d) storm
9. The technical \_\_\_\_\_ for electrical equipment can vary from country to country.
- a)justification            b)rules            c)specifications            d)uniforms
10. Among other things, a \_\_\_\_\_ contains details of the goods, their destination and the name of the ship carrying them.
- a)bill of lading            b)way-bill            c)bill of exchange            d)receipt
11. The person the goods are sent to is called a \_\_\_\_\_ .
- a) consignor    b)consignee    c)commissioner            d)master
12. She looked at the \_\_\_\_\_ to check where the goods were produced.
- a)certificate of origin    b)test certificate            c)postmark            d)trademark

12 points

4. *Join the beginning of each phrase with the appropriate ending.*

1. Following your advertisement in the "Daily"...
2. Please find enclosed...
3. We regret to inform you that...
4. We look forward to...
5. We acknowledge receipt of...
6. Please accept our sincere apologies...
7. I am writing...
8. Should you require any further information...
9. We would be grateful if you could...
10. We would be very interested in receiving...
11. I would like to reserve...
12. Should you be interested...

- a. ... **your order will be one week late.**
- b. ... **your letter dated 12th January 2010.**
- c. ... **please do not hesitate** to contact us.
- d. .... **a visit from your salesman.**
- e. .... **to enquire about your range of software.**
- f. .... **send us a quotation for 20 items.**
- g. ... **in taking the matter further...**
- h. ... **I am writing to apply for the position of...**
- i. .... **a double room in the name of Smythe.**
- j. ... **doing business with you in the near future,**
- k. .... **for the inconvenience you have been caused.**
- l. .... **a copy of our brochure and price list.**

12 points

5. *Put the phrases in the right order.*

- a) to you look I meeting forward
- b) to delivery am I confirm writing
- c) enclosed find please
- d) of your 15th you letter thank for April



4

- e) sincerely yours
- f) regards with best
- g) information you any require further should
- h) letter please of receipt this acknowledge
- i) hesitate us to contact do please not
- j) to catalogue shall send we be you our pleased

10 points

6. *Choose the right definition*

1. E-business	Economic business Electronic business
2. T-commerce	Total commerce Television commerce
3. C2B	Customer to business Client to boss
4. B2B	Buyer to boss Business to business
5. IMO	International monetary organization in my opinion
6. IMHO	In my humble opinion International monetary help organization
7. OTL	Over the limit Out to lunch
8. HSIK	How should I know Have something in kit
9. BBL	Bring back later Be back later
10. TTYL	Talk to you later The time you left
11. NOYB	Not only your business None of your business
12. FWIW	<b>For what it's worth</b> Full with internet words
13. IRC	Internet relay chat Internal relay comment

13 points

Total Score: 100 points

## Intermediate Lexical-Grammar Test

(К пособию по практическому курсу научно-технического перевода для студентов технических специальностей автотракторного факультета Units 1-2, Variant 1)

**1. Переведите слова в скобках на английский язык и поставьте их в нужную форму.**

- 1) (Поршень) is connected to the (коленчатый вал).
- 2) The (свеча зажигания) emits a spark to (воспламенить) the gasoline.
- 3) The intake or (выхлопной) valves (не изолированы) properly.
- 4) If the (прокладка) breaks down small (отверстия) develop between the cylinder and the cylinder head.
- 5) There is such a thing as an (двигатель внутреннего сгорания).
- 6) The cylinders are small and each individual (такт зажигания) produces comparatively little power.

9 points

**2. Выберите правильный вариант перевода предложений на русский язык.**

- 1) There are about 3,000 Americans who like to collect antique cars.
  - a) Около 3,000 американцев любят коллекционировать античные автомобили.
  - b) Многие, как и 3,000 американцев, любят коллекционировать античные автомобили.
  - c) 3,000 американцам нравится коллекционировать автомобили, которые напоминают античные.
- 2) The annual Geneva Motor Show is one of the best automotive events of the year.
  - a) Ежегодное мотошоу в Женеве – это единственное авто событие года.
  - b) Ежегодное мотошоу в Женеве – это одно из лучших авто событий года.
  - c) Ежегодное мотошоу в Женеве – это самое лучшее авто событие года.

- 3) The hybrid car has a gasoline engine much like the one you will find in most cars.
- Гибридная машина имеет бензиновый двигатель во многом напоминающий те, которые вы можете найти в большинстве обычных автомобилей.
  - Гибридная машина имеет бензиновый двигатель такой же, как и во многих других машинах.
  - Гибридная машина имеет бензиновый двигатель совсем не такой, как в большинстве других машинах.

3 points

**3. Заполните пропуски выделенными словами.**

Spark, crankshaft, bearings, valves, hole, engine, piston, connecting rod, reciprocating internal combustion engine, oil, exhaust, suspension, camshaft

- The most common ... in a cylinder occurs where the top of the cylinder attaches to the cylinder head.
- The ... might be nonexistent or weak for a number of reasons.
- If the ... do not open and close at the right time or at all, air cannot get in and ... cannot get out, so the ... cannot run.
- The piston is connected to the ... by a ... .
- Almost all cars today use a ... .
- If you run out of ... , the ... cannot move up and down freely in the cylinder; and the engine will seize.

10 points

**4. Переведите предложения на русский язык, обращая внимание на перевод инфинитива.**

- The spark plug emits a spark to ignite the gasoline.
- The purpose of a gasoline car is to convert gasoline into motion.
- The easiest way to create motion from gasoline is to burn the gasoline inside the engine.
- The piston moves back up to compress this fuel/air mixture.
- This engine is relatively easy to refuel.

6) The fuel in a steam engine burns outside the engine to create steam.

6 points

**5. *Переведите предложения на английский язык.***

- 1) Если ваша машина не заводится, бензиновый насос может быть сломан или бензиновая труба может быть засорена.
- 2) Двигатель в машине выглядит как большая беспорядочная мешанина металла, различных трубок и проводов.
- 3) Три основные вещи могут случиться: плохая топливная смесь, недостаток искры и недостаток сжатия.
- 4) Сегодня почти у всех машин поршневой двигатель внутреннего сгорания.
- 5) Увеличив количество цилиндров, вы можете получить больше рабочего объема двигателя.
- 6) Камера сгорания – это место, где происходит сжатие и сгорание.

6 points

Total score: 34 points

## Intermediate Lexical-Grammar Test

(К пособию по практическому курсу научно-технического перевода для студентов технических специальностей автотракторного факультета Units 1-2, Variant 2)

### 1. *Переведите слова в скобках на английский язык и поставьте их в нужную форму.*

- 1) (Поддон) contains some amount of oil
- 2) The (рабочий объем) tells you something about how much power an engine can produce.
- 3) A car engine can look like a big confusing (мешанина) of metal, tubes and (проводов).
- 4) The air intake might be (засорено), so there is fuel but not enough air.
- 5) There might be an (загрязнение) in the fuel that makes the fuel not burn.
- 6) If the (подшипники) that allow the (коленчатый вал) to turn freely are work out, the (коленчатый вал) cannot turn so the engine cannot run.

9 points

### 2. *Выберите правильный вариант перевода предложений.*

- 1) The car engine looks like a big, confusing jumble of metal.
  - a) Двигатель автомобиля – это большая, непонятная груда металла.
  - b) Двигатель автомобиля слегка напоминает большую, непонятную груду металла.
  - c) Двигатель автомобиля выглядит, как большая, непонятная груда металла.
- 2) One of the most important things for the driver to know is to drive at the right speed.
  - d) Единственная важная вещь, которую водитель должен знать – это ехать на оптимальной скорости.
  - e) Самая важная вещь, которую водитель должен знать – это ехать на оптимальной скорости.
  - f) Одна из самых важных вещей, которую водитель должен знать – это ехать на оптимальной скорости.
- 3) They have supplied the car with too little fuel.
  - g) Они залили в машину слишком мало топлива.
  - h) Они тоже залили в машину мало топлива.
  - i) Они залили в машину слишком много топлива.

3 points

3. ***Заполните пропуски выделенными словами***

Intake, acceleration, exhaust, valves, light weight battery, service station, power, sump, piston rings

- 1) Increased ... has reduced the ... time and slightly increased the top speed.
- 2) The ... and ... valves open at the proper time.
- 3) The main aim of the ... is to prevent the fuel/air mixture from leaking into the ... during compression and combustion.
- 4) If the ... do not open and close at the right time, air cannot get in and exhaust cannot get out.
- 5) Success of the electric cars depends on ... .
- 6) If you are a poor mechanic you should stop at the ... periodically.

9 points

4. ***Переведите предложения на русский язык, обращая внимание на перевод глагола в пассивном залоге и модальных глаголов.***

- 1) The air intake might be clogged, so there is fuel but not enough air.
- 2) If your car does not start, the petrol pump may be broken or the fuel pipe may be blocked.
- 3) The modern automobile has often been described as a computer on wheels.
- 4) New models are regularly subjected to a number of standardized tests which make it possible to compare results.
- 5) Other sensors are being added as car manufactures add side impact bags.
- 6) The power output has been boosted by a supercharger.

6 points

5. ***Переведите предложения на английский язык***

- 1) Поршень соединен с коленчатым валом шатуном.
- 2) Если искра появляется либо слишком рано либо слишком поздно, топливо не воспламенится в нужное время.
- 3) Свечи зажигания дают искру, чтобы бензин воспламенился.
- 4) Камера сгорания – это место где происходит сжатие и сгорание.
- 5) Сердцевина двигателя – это цилиндр, с поршнем,двигающимся вверх и вниз внутри цилиндра.
- 6) Новый Eclipse автомобили появились на мотошоу и их цена стартовала от 20 000 долларов США.

6 points

Total score: 34 points

## Intermediate Lexical-Grammar Test

(К пособию по практическому курсу научно-технического перевода для студентов технических специальностей автотракторного факультета Units 3-4, Variant 1)

### **1. Переведите слова в скобках на английский язык и поставьте их в нужную форму.**

- 1) The exhaust system includes (выхлопная труба) and (глушитель).
- 2) Diesel fuel (впрыскивается) into the cylinder and the heat and pressure of the compression stroke (заставляют) the fuel to (воспламеняться).
- 3) (Легковесные) parts help the engine perform better.
- 4) This (подход) has more moving parts and also (вызывает) more (запаздывание) between the cam's activation of the valve and subsequent motion of the valve.
- 5) The (распределитель) has one wire going in the center and four, six or eight wires coming out of it.
- 6) Higher (коэффициенты сжатия) produce more power, up to a point

11 points

### **2. Выберите правильный вариант перевода предложений на русский язык.**

- 1) The higher the pressure, the higher the temperature.
  - a) Повышение давления приводит к повышению температуры.
  - b) Чем выше давление, тем выше температура.
  - c) Повышение давления обусловлено повышением температуры
- 2) The cooling system in most cars proves to consist of the radiator and water pump.
  - d) Оказывается, система охлаждения в большинстве автомобилей состоит из радиатора и водяного насоса.
  - e) Доказали, что система охлаждения в большинстве автомобилей состоит из радиатора и водяного насоса
  - f) Система охлаждения в любом автомобиле состоит из радиатора и водяного насоса.
- 3) Mass production of this model was to begin in a year.
  - g) Массовое производство этой модели началось в прошлом году.
  - h) Массовое производство этой модели должно было начаться через год.
  - i) Массовое производство этой модели началось в этом году.

3 points

**3. Заполните пропуски выделенными словами.**

Camshaft, lubrication system, displacement, valve train, alternator, turbocharged, supercharged, exhaust pipe, muffler, displacement

- 1) More .... means more power because you can burn more gas during each revolution of the engine.
- 2) If the ... is too small or the... has a lot of air resistance, this can cause back-pressure.
- 3) The .... consists of the valves and a mechanism that opens and closes them, which is called a ....
- 4) The electrical system consists of a battery and an .....
- 5) High-performance engines are either ..... or ....., which means that air coming into the engine is first pressurized to increase ....
- 6) The ... makes sure that every moving part in the engine gets oil so that it can move easily.

9 points

**4. Переведите предложения на русский язык, обращая внимание на перевод причастия и инфинитивного оборота «сложное подлежащее».**

- 1) Using more gasoline and burning lots of oil, the two-stroke engine is far more polluting.
- 2) Turbochargers and superchargers pressurize the incoming air to cram more air into a cylinder.
- 3) Ford, Daimler-Benz and Ballard are expected to accelerate further the development of fuel-cell-powered components for cars and trucks.
- 4) A blocked filter decreases the air flow to the carburetor, thus increasing the amount of fuel in the mixture.
- 5) At the beginning of the 20th century a new car design seemed to be a fantasy.
- 6) Air resistance can be lessened by putting two intake valves in each cylinder.

6 points

**5. Переведите предложения на английский язык.**

- 1) Автомобили с высокими эксплуатационными характеристиками обычно используют высокий коэффициент сжатия, чтобы получить большую мощность.
- 2) Электрическая система автомобиля состоит из аккумулятора и генератора переменного тока.
- 3) Поршень соединяется с коленчатым валом при помощи шатуна.



- 4) Разница между максимальным и минимальным объемом называется рабочим объемом и измеряется в литрах или кубических сантиметрах.
- 5) Двухтактный двигатель не имеет движущихся клапанов.
- 6) Система зажигания производит электрический заряд высокого напряжения и передает его к свечам зажигания.

6 points

Total score: 35 points

## Intermediate Lexical-Grammar Test

(К пособию по практическому курсу научно-технического перевода для студентов технических специальностей автотракторного факультета Units 3-4, Variant 2)

### **1. Переведите слова в скобках на английский язык и поставьте их в нужную форму.**

- 1) The hotter air is, the less it will (расширяться) when combustion takes place.
- 2) Most modern engines have what are called (верхние кулачки).
- 3) (Дизельное топливо) has a higher energy (плотность) than gasoline, so a diesel engine gets better (пробег).
- 4) The (генератор переменного тока) is connected to the engine by a (ремень) any generates electricity to (перезарядить) the battery.
- 5) Higher-octane gasoline (предотвращает) this sort of early combustion.
- 6) A turbocharger uses a small turbine (прикрепленный) to the exhaust pipe to spin a compressing turbine in the (поток входящего воздуха).

11 points

### **2. Выберите правильный вариант перевода предложений на русский язык.**

- 1) Gas turbine is about three times as powerful as a piston engine of the same weight .
  - a) Газовая турбина почти в три раза мощнее, чем поршневой двигатель такого же веса.
  - b) Газовая турбина почти в три раза мощнее поршневого двигателя и весит столько же.
  - c) Газовая турбина не такая мощная, как поршневой двигатель, хоть и весит столько же.
- 2) Since the density of titanium is about half that of steel, titanium can perform the same task as steel springs.
  - d) Так как плотность титана в два раза больше, чем у стали, титан может выполнять те же функции, что и стальные рессоры
  - e) С тех пор как плотность титана стала в два раза меньше, чем у стали, титан стал выполнять те же функции, что и стальные рессоры.
  - f) Так как плотность титана в два раза меньше, чем у стали, титан может выполнять те же функции, что и стальные рессоры.
- 3) The lighter the piston, the less energy it takes.
  - g) Чем светлее поршень, тем меньше энергии он потребляет.
  - h) Чем легче поршень, тем меньше энергии он потребляет.
  - i) Легкий поршень потребляет меньше энергии.

3 points

3. **Заполните пропуски выделенными словами.**

Catalytic converter, high-performance, timing chain, sump, actuators, camshafts, rotation, intercooler, two-stroke engine.

- 1) A ... produces a lot of power for its size because there are twice as many **combustion cycles occurring per ...** .
- 2) Many ... engines have **four valves per cylinder and this arrangement requires two ... per bank of cylinders.**
- 3) An ... is a special radiator through which the compressed air passes to cool it off.
- 4) The emission control system consists of a ... , a collection of sensors and ... and some other things.
- 5) The oil trickles down into the ... , where it is collected again and the cycle repeats.
- 6) A ... **links** the crankshaft to the camshaft so that the valves are in sync with the pistons.

9 points

2. **Переведите предложения на русский язык, обращая внимание на перевод причастия и инфинитивного оборота «сложное подлежащее».**

- 1) The compressed air passes through the intercooler.
- 2) The electric automobile energized by rechargeable batteries appeared to have a great future nearly a century ago.
- 3) You can cram more air and fuel into a cylinder of a given size.
- 4) Some newer cars are using polished intake manifolds to eliminate air resistance.
- 5) Most drivers are found to have phones in their vehicles or carry phones when they drive.
- 6) Increasing the size of the cylinder, you can get more power from it.

6 points

3. **Переведите предложения на английский язык.**

- 1) Старые двигатели использовали распределительный вал, который размещался в поддоне картера рядом с коленчатым валом.
- 2) Главное преимущество парового двигателя заключается в том, что он может использовать в качестве топлива все, что горит.

- 3) Выхлопная система автомобиля включает в себя выхлопную трубу и глушитель.
- 4) Газораспределительный механизм состоит из клапанов и механизма, который открывает и закрывает его.
- 5) Г. Ройс и Ч. Роллс решили спроектировать самый комфортабельный и надежный автомобиль.
- 6) Любой дизельный двигатель, как известно, снабжен ручной или автоматической коробкой передач.

6 points

Total score: 35 points

## Intermediate Lexical-Grammar Test

(К пособию по практическому курсу научно-технического перевода для студентов технических специальностей автотракторного факультета Units 5-6, Variant 1)

### **1. Переведите выделенные слова на английский язык, используя активный словарь.**

- 1) Inside, brushed aluminium components including the pedals, centre console and (рычаг переключения передач), emphasized the dynamic design of the R 32.
- 2) The new front seats with (встроенные подголовники) and the special R 32 leather (рулевое колесо) were designed for more sporty driver.
- 3) The R 32 is the (высококласный) model in the Golf series.
- 4) The Jaguar X-type Estate will have a sedan engine and a choice between front-wheel (привод) and (полноприводный).
- 5) There is also a seat (датчик присутствия) and a (система контроля давления в шинах).
- 6) The body has (торсионную жёсткость) greater than its previous model.

9 points

### **2. Выберите правильный вариант перевода предложений на русский язык.**

- 1) A modern car is a complex means of transport.
  - a) Современный автомобиль – это комплексное средство передвижения.
  - b) Современный автомобиль – это комплекс средств передвижения.
  - c) Современный автомобиль – это сложное средство передвижения.
- 2) If the battery appears to be flat it is necessary to recharge it.
  - a) Если батарея оказывается плоской, её нужно перезарядить.
  - b) Если батарея кажется разряженной, её нужно перезарядить.
  - c) Если оказывается, что батарея разряжена, её нужно перезарядить.
- 3) Cars operate in a wide variety of temperature.
  - a) Автомобили оперируют при большом разнообразии температур.
  - b) Автомобили работают с разнообразием температур.
  - c) Автомобили работают при разных температурах.

3 points

### **3. Заполните пропуски выделенными словами.**

Front, rear, exhaust, system, tailpipes, anti- dazzle, heated seats, headlights, ensure, throttle, control, gearbox, driveability, pedal, design, response, equipment

- 1) Electronic... .. has improved ... and a lighter ... action.

- 2) Golf is characterized by significant ... modifications to the ... and ... section.
- 3) Electro-hydraulic power steering ... a positive ... to the driver.
- 4) The R 32 has double ... with twin chrome-plated ...
- 5) Golf has a range of standard ... including ... interior mirror, ... , and ... with washer system.
- 6) Two ... first appeared on the Vectra : the five - speed automatic and CVTronic.

14 points

**4. Переведите предложения на русский язык, обращая внимание на перевод глаголов в пассивном залоге.**

- 1) The new front sport seats with built-in head restraints and special leather steering wheel were designed for more sporty drivers.
- 2) As the engine operates, the valves are successively opened and closed, the moment of ignition of the fuel must also be controlled.
- 3) A great attention has been given to the exterior.
- 4) Research is being conducted to develop well-designed in vehicle human/machine interfaces for safe driving.
- 5) The power of the engine is transmitted via a six-speed gearbox.
- 6) When the spark plugs are adjusted properly, they produce a spark.

6 points

**5. Переведите предложения на русский язык, обращая внимание на перевод неличных форм глагола.**

- 1) Having entered the engine, impurities damaged the cylinders, piston and piston rings.
- 2) The R 32 designed by Volkswagen can accelerate to 100 kph in just 6.6 seconds.
- 3) Brushed aluminium components including the pedals, centre console and gear lever, emphasized the dynamic design of the R 32.
- 4) By summing up the information about the speed and distance of various objects on the road, the computer detects all possible dangers.
- 5) A new carburetor offers easier starting in cold weather.
- 6) Being oiled, the moving parts work almost without friction.

6 points

**6. Переведите предложения на английский язык.**

- 1) Автомобиль оборудован системой безопасности, включающей воздушную подушку и подголовники-ограничители.
- 2) Это тело обладает большей торсионной жёсткостью, чем предыдущая модель.

- 3) Целью данной книги является описание электрических инструментов в машине.
- 4) Новая батарея, которую нужно использовать в этой машине, очень эффективная.
- 5) Так как свечи зажигания очистили, они произвели искру.
- 6) Устранив неисправность, водитель уехал со станции техобслуживания.

12 points

Total score: 50 points

## Intermediate Lexical-Grammar Test

(К пособию по практическому курсу научно-технического перевода для студентов технических специальностей автотракторного факультета Units 5-6, Variant 2)

### ***1. Переведите выделенные слова на английский язык, используя активный словарь.***

- 1) This is an electronic management system that interacts with the chassis, (управление) and braking for increasing driver (обратная связь), comfort and (безопасность).
- 2) Two (коробка передач) are used on the Vectra: the five-speed automatic with (ручное переключение) function and the CVTronic.
- 3) In the event of (столкновения) the (педали тормоза и сцепления) are disengaged to protect the driver from (повреждения).
- 4) There are three petrol and diesel engines with (выходная мощность) from 122 ps to 211 ps.
- 5) The new model of the car has automatic airconditioning, (литые диски), multi-function computer and some other elements.
- 6) Golf has a range of standard equipment including (противоослепляющие) interior mirror, (сиденья с подогревом), and (фары) with washer system.

13 points

### ***2. Выберите правильный вариант перевода предложений на русский язык.***

- 1) As the engine operates, the valves are successively opened and closed.
  - a) Как двигатель работает, клапаны последовательно открывают и закрывают.
  - b) Пока двигатель не заработает, клапаны не откроются и не закроются.
  - c) Когда двигатель работает, клапаны последовательно открываются и закрываются.
- 2) Since 1970 there were many brilliant inventions in the automobile industry.
  - a) С 1970 года в автомобильной индустрии было много бриллиантовых изобретений.
  - b) С 1970 года в автомобильной промышленности было много ярких изобретений.
  - c) С 1970 года в автомобильной промышленности было много выдающихся изобретений.
- 3) All the mechanisms in the car but one were operating in a proper way.
  - a) Почти все механизмы в автомобиле работали должным образом.
  - b) Лишь один механизм в автомобиле работал должным образом.
  - c) Все механизмы, кроме одного, работали должным образом.

3 points



### **3. Заполните пропуски выделенными словами.**

Safety, head restraints, airbag, impact, brake, clutch pedals, alloy wheels, gearbox, power output, torsional stiffness

- 1) The new model of the car has automatic airconditioning, ..., multi-function computer and some other elements.
- 2) The car is equipped with ... features, including ..... and ....
- 3) It also possesses a ... with interior reduced gear gate.
- 4) The body has ..... greater than its previous model.
- 5) In the event of ... the ... and ..... are disengaged to protect the driver from injuring.
- 6) There are three petrol and diesel engines with ..... from 122 ps to 211 ps.

10 points

### **4. Переведите предложения на русский язык, обращая внимание на перевод глаголов в пассивном залоге.**

- 1) The gas engine was greatly improved by the use of liquid fuels.
- 2) The mixing is carried out in a carburettor.
- 3) Technology developed for the aeronautical industry has been used, giving an aerodynamic design full of elegance and clarity of line.
- 4) If the driver's car is too close, it will be gently braked, automatically, until sufficient distance is restored.
- 5) Brakes must be applied to stop a car in case of emergency.
- 6) If the engine is tested, it may be started.

6 points

### **5. Переведите предложения на русский язык, обращая внимание на перевод неличных форм глагола.**

- 1) It is impossible to solve economic problems without using the achievements of the scientific and technological revolution.
- 2) Being damaged the car needs a serious overhaul.
- 3) If removed impurities cannot block the carburettor.
- 4) We were interested in analysing this phenomenon.
- 5) A driver must examine the car before starting on a long journey.
- 6) Having been cleaned the filter increased the airflow.

6 points

**6. Переведите предложения на английский язык.**

- 1) Новый карбюратор позволяет легче заводить двигатель в холодную погоду.
- 2) Попад в двигатель, примеси повредили цилиндры, поршень и поршневые кольца.
- 3) После того как новую тормозную систему испытали, её одобрили.
- 4) Так как движущиеся детали смазали, они работают без трения.
- 5) Новая топливная система, которую разработали, будет иметь ряд преимуществ.
- 6) Бензин, который нужно доставить в карбюратор, должен быть чистым.

12 points

Total score: 50 points

## Intermediate Lexical-Grammar Test

(К пособию по практическому курсу научно-технического перевода для студентов технических специальностей автотракторного факультета Units 7-8, Variant 1)

### ***1. Переведите выделенные слова на английский язык, используя активный словарь.***

- 1) (Тарельчатые клапаны) are cooled by transferring heat to the engine (чехол), mostly through the (стержень клапана).
- 2) The operating (сцепление) consists of (толкатель клапана), (штанга толкателя клапана) and (рокера).
- 3) (Выхлопные клапаны) are subjected to the effects of extreme temperature and must be most carefully designed.
- 4) The fuel tank in a hybrid is the energy (хранение) device for the gasoline engine.
- 5) The engine on a hybrid is smaller and uses advanced technologies (снизить) (выбросы) and increase (производительность).
- 6) Any (транспортное средство) is a hybrid when it combines two or more sources of power.

13 points

### ***2. Выберите правильный вариант перевода предложений на русский язык.***

- 1) One of the main components of any vehicle is the engine.
  - a) Один, главный компонент транспортного средства – это двигатель.
  - b) Важнейший компонент транспортного средства – это двигатель.
  - c) Один из главных компонентов транспортного средства – это двигатель.
- 2) There wasn't much room for the passengers in the Mini.
  - a) В Мини было мало комнат для пассажиров.
  - b) В Мини была маленькая комната для пассажиров.
  - c) В Мини было мало места для пассажиров.
- 3) One of the ways we can reduce the amount of pollution from traffic is to use renewable resources.
  - a) Один способ, которым мы можем снизить количество загрязнений от транспорта – это использовать возобновляемые источники энергии.
  - b) Единственный способ, с помощью которого мы можем снизить количество загрязнений от транспорта – это использовать возобновляемые источники энергии.
  - c) Один из способов, которым мы можем снизить количество загрязнений от транспорта – это использование возобновляемых источников энергии.

3 points

### **3. Заполните пропуски выделенными словами.**

Storage, supply, turn, poppet valve, jacket, valve stem, valve-lifter, convex, lever

- 1) ..... are cooled by transferring to the engine ... , mostly through the .....
- 2) A ..... is riding on each cam, which may be a flat or slightly ... surface.
- 3) A gas-powered car has a fuel tank which ... gasoline to the engine.
- 4) The fuel tank in a hybrid is the energy ... device for the gasoline engine.
- 5) The motor ... a transmission and the transmission ... wheels.
- 6) ... is a lever, pivoted near its center.

10 points

### **4. Переведите предложения на русский язык, обращая внимание на употребление многофункциональных слов " that " и " since " .**

- 1) The weight of diesel engine is more than that of a gasoline engine of the same power and it occupies much space.
- 2) In a **typical parallel hybrid** you'll notice that the fuel tank and gas engine connect to the transmission.
- 3) A car that burns twice as much gas to go a mile will generate approximately twice as much pollution.
- 4) Since the end of the World War II there has been a rapid development of jet engines.
- 5) Since the first electric car appeared many changes have taken place in the field of automobile industry.
- 6) Since the jet engine is a powerful source of energy, it is widely used for machines flying at supersonic speed.

6 points

### **5. Переведите предложения на русский язык, обращая внимание на перевод неличных форм глагола.**

- 1) Instead of using brakes to stop the car the electric motor can also slow down the car.
- 2) The function of a car computer is detecting and summing up the information about the road conditions.
- 3) The events to be analyzed are the actions taken during the operations of a car.
- 4) The car supplied with solar batteries does not pollute the environment.
- 5) Certain tests may require the test vehicle to be equipped with particular devices to ensure reliable results.
- 6) This analysis permitted new data to be obtained.

6 points

**6. Переведите предложения на английский язык.**

- 1) Автомобиль, работающий на газе, имеет топливный бак, который снабжает бензином двигатель.
- 2) Снижение потребления топлива автомобилем – один из самых лучших способов уменьшения выбросов.
- 3) Тарельчатые клапаны обычно 2 дюйма в диаметре или меньше.
- 4) Любое транспортное средство является гибридом, когда оно сочетает 2 или более источников энергии.
- 5) В обычном гибриде с параллельным приводом топливный бак и газовый двигатель соединяются с передачей.
- 6) Газовый двигатель был значительно усовершенствован использованием жидкого топлива.

12 points

Total score: 50 points

## Intermediate Lexical-Grammar Test

(К пособию по практическому курсу научно-технического перевода для студентов технических специальностей автотракторного факультета Units 7-8, Variant 2)

### **1. Переведите выделенные слова на английский язык, используя активный словарь.**

- 1) An internal combustion engine is a (поршневой насос), able to draw in a certain amount of air per minute.
- 2) (Тарельчатые клапаны) are cooled by transferring heat to the engine (чехол), mostly through the (стержень клапана).
- 3) The (штанга толкателя клапана) is a light rod or tube with ball ends which carries the motion of the cam-follower to the (рокера).
- 4) The amount of (загрязнение) allowed does not depend on the (пробега) your car gets.
- 5) In a (гибрид с параллельным приводом) both the electric motor and the gas engine can provide (движущая сила) power.
- 6) The reason is (двойкий): (сократить) tailpipe (выбросы) and to improve mileage.

13 points

### **2. Выберите правильный вариант перевода предложений на русский язык.**

- 1) Advanced electronics allow the electric motor to act as a motor as well as a generator.
  - a) Усовершенствованная электроника позволяет электрическому двигателю работать как двигатель также хорошо, как и двигатель.
  - b) Усовершенствованная электроника позволяет электрическому двигателю работать в качестве двигателя и генератора.
  - c) Усовершенствованная электроника позволяет электрическому двигателю работать в качестве двигателя также как и в качестве генератора.
- 2) As the engine is turning slowly the alternator is also turning slowly.
  - a) Как двигатель медленно вращается, так и генератор переменного тока вращается медленно.
  - b) Пока двигатель медленно вращается, до тех пор и генератор переменного тока вращается медленно.
  - c) Так как двигатель вращается медленно, генератор переменного тока также вращается медленно.
- 3) Among possible sources of power for engines one has to consider the possibility of applying atomic energy.
  - a) Среди возможных источников энергии для двигателей один должен рассмотреть возможность применения атомной энергии.
  - b) Возможность применения атомной энергии является одной из множества

источников энергии для двигателей.

с) Среди возможных источников энергии для двигателей нужно рассмотреть возможность применения атомной энергии.

3 points

**3. Заполните пропуски выделенными словами.**

Vehicle, propulsion, reduce, emissions, efficiency, provide, valve head, valve stem, valve guide, exhaust valves, reciprocating pump

- 1) ... .. is held concentric with its seat by a cylindrical ... .. running in the ... .. .
- 2) ... .. are subjected to the effects of extreme temperature and must be most carefully designed.
- 3) An internal combustion engine is a ... .. , able to draw in a certain amount of air per minute.
- 4) Any ... that combines two or more sources of power is a hybrid.
- 5) The engine on a hybrid is smaller and uses advanced technologies ... .. and increase ... .
- 6) As a result in a parallel hybrid both the electric motor and gas engine can ... propulsion power.

11 points

**4. Переведите предложения на русский язык, обращая внимание на употребление многофункциональных слов "that" и "since".**

- 1) Another important problem is that of fuel.
- 2) Any vehicle that combines two or more sources of power is a hybrid.
- 3) It is essential that the flow through the engine can be restricted as little as possible.
- 4) Since the fuel takes up little space but needs air with which to combine, the power output of an engine is limited by its air- pumping capacity.
- 5) Ever since 1904 the trade name of Rolls- Royce has always been the perfect car.
- 6) Since the French engineer Cugnot invented the first self-propelled vehicle in 1770, the automobile industry developed very rapidly.

6 points

**5. Переведите предложения на русский язык, обращая внимание на перевод неличных форм глагола.**

- 1) The function of the speedometer is to indicate the speed of a car.
- 2) The car emissions to be controlled are very harmful to the environment.
- 3) Differential is the device that permits the rear wheels to revolve at different

speeds independently one of the other.

4) Monitoring and adjusting air pressure in tyres is one of the newest developments of the car designers.

5) If not repaired the exhaust system will have to be replaced.

6) Having discovered a broken pump, it is a good idea to repair or replace it.

6 points

**6. Переведите предложения на английский язык.**

1) Клапаны обычно изготавливают из нержавеющей стали, которая будет поддерживать его форму при высокой температуре.

2) Система зажигания делится на 2 цепи: цепь низкого давления и высокого.

3) Топливный бак в гибридной машине – это устройство сохранения энергии для бензинового двигателя.

4) Электрический двигатель в гибридном автомобиле – очень сложный.

5) Водитель может избегать столкновений на дороге, используя радарную систему.

6) Автомобиль, работающий на водороде, был изобретён давным-давно.

12 points

Total score : 50 points



## Intermediate Lexical-Grammar Test

(К пособию по практическому курсу научно-технического перевода для студентов технических специальностей автотракторного факультета Units 9-10, Variant 1)

**1. Переведите слова в скобках на английский язык и поставьте их в нужную форму.**

- 1) Because of the three valve technology and the (изолированный коллектор с воздушным промежутком) the (поперечно расположенный катализатор) reaches its operating temperature just a few seconds after the engine is started from cold.
- 2) The shifter has a C-shaped (кулилка) allowing (полуавтоматическое переключение).
- 3) This includes (двойное зажигание), three valve technology, automatic (выключение цилиндра) and low friction (гильзы цилиндра).
- 4) (Плавность) and low noise emissions are fully retained during (выключение цилиндра).
- 5) The Lexus SC 430 has excellent seat belts and side-impact (воздушная подушка).
- 6) (Выпускные клапаны) help reduce heat loss inside the engine.

11 points

**2. Выберите правильный вариант перевода предложений на русский язык.**

- 1) People's emotions are said to play the most important role in the purchase of their automobile.
  - a) Говорят, что человеческие эмоции играют самую важную роль при покупке автомобиля.
  - b) Люди эмоционально говорят, что игра самая важная часть при покупке автомобиля.
  - c) Человеческие эмоции играют самую важную роль при покупке автомобиля.
- 2) Ford cars are equipped with an electronic instrument panel that calculates how far one can drive on the fuel left in the tank.
  - a) Автомобили Ford оборудованы электронной приборной панелью, которая подсчитывает, как далеко можно уехать на топливе слева от бака.
  - b) Автомобили Ford оборудованы электронной приборной панелью, которая подсчитывает, как далеко можно уехать на топливе, которое осталось в баке.

- c) Автомобили Ford оборудованы электронной приборной панелью, которая подсчитывает, как далеко может уехать один человек на топливе, которое осталось в баке.
- 3) The air compressed passes through the intercooler.
- a) Воздух сжимается и проходит через промежуточный охладитель.
- b) Сжатый воздух проходит через промежуточный охладитель
- c) Воздух сжался и прошел через промежуточный охладитель.

3 points

**3. Заполните пропуски выделенными словами.**

Semi-manual gearshift, tires, traction control, crankcase, catalytic converters, maintains, intake manifold, misfiring, shut-off

- 1) Active safety system includes ABS, EBD, ... , VCS and Brake Assist.
- 2) Automatic cylinder ... is expected to interrupt the link between the valves and camshaft hydraulically by locking the valve control arms.
- 3) The ... can sense changes in engine performance.
- 4) Electronic Brake Force Distribution ... the proper balance of braking force to all four ... .
- 5) The new engine can instantly identify and cure any ... , which helps protect the ... .
- 6) The ... is made of aluminium, with magnesium used for the ... .

9 points

**4. Переведите предложения на русский язык, обращая внимание на перевод инфинитива и инфинитивного оборота «сложное подлежащее».**

- 1) All models are supposed to use a floor mounted handbrake (parking brake) lever located between the front seats.
- 2) The reality of today is that the automotive engineer is expected to know about far more than just mechanical engineering.
- 3) The ignition system is sure to be controlled both mechanically and by a vacuum operated system.
- 4) The three-valve technology is also known to have helped in weight loss.
- 5) **The “night vision” system is to be small enough to be used in automobiles.**
- 6) The principle of lightweight design is certain to be evident for Mercedes cars.

6 points

5. *Переведите предложения на английский язык.*

- 1) Картер двигателя сделан из алюминия, а магний используется для впускного коллектора.
- 2) Еще одним преимуществом этого двигателя считается его выхлопная система.
- 3) Время разгона Lexus SC 430 сравнимо со временем разгона Mercedes SL 500.
- 4) Такая инновация, как система контроля транспортного средства при заносе, может помочь вам избежать несчастных случаев на дороге.
- 5) Lexus SC 430 движется плавно и тихо.
- 6) Выпускные клапаны помогают уменьшить потери тепла внутри двигателя.

6 points

Total score: 35 points

## Intermediate Lexical-Grammar Test

(К пособию по практическому курсу научно-технического перевода для студентов технических специальностей автотракторного факультета Units 9-10, Variant 2)

### **1. Переведите слова в скобках на английский язык и поставьте их в нужную форму.**

- 1) During (частичной загрузки) operation this cures the (присущие недостатки) of large-displacement engines.
- 2) The Lexus is not intended to be driven like (гоночный автомобиль).
- 3) The (выхлопной коллектор) is made of laser welded, high-pressure formed (листовая сталь).
- 4) (Регулирование тягового усилия) reduces (пробуксовывание задних колес) when accelerating on (скользкой) surfaces.
- 5) (Динамические показатели) of Lexus SC is comparable to that of Mercedes and Jaguar.
- 6) ABS prevents (тормоза) from locking up so that the driver (поддерживает) steering control.

7 points

### **2. Выберите правильный вариант перевода предложений на русский язык.**

- 1) A special electronic device signals the engine to stop.
  - a) Сигнал специального электронного устройства останавливает двигатель.
  - b) Специальное электронное устройство дает двигателю сигнал, остановиться.
  - c) Специальное электронное устройство сигнализирует об остановке двигателя.
- 2) On tests Golf proved to be well built and spacious for its size.
  - a) При испытаниях Golf доказал, что он хорошо сконструирован и просторен для своего размера.
  - b) Во время испытаний оказалось, что Golf хорошо сконструирован и занимает много места для своего размера.
  - c) При испытаниях оказалось, что Golf хорошо сконструирован и просторен для своего размера.
- 3) Increasing the size of the cylinder, you can get more power.
  - a) Увеличивая размер цилиндра, вы можете получить большую мощность.
  - b) Увеличенный размер цилиндра дает вам большую мощность.
  - c) Увеличьте размер цилиндра и вы сможете получить большую мощность.

3 points

**3. Заполните пропуски выделенными словами.**

Maintain, cylinder banks, powerplant, roller-type rocker arms, smoothly, bulkhead catalytic converters, steer, brake pedal, torque

- 1) **One camshaft in each of the two ... operates the valves via low-friction ... .**
- 2) **Each cylinder bank features two ... .**
- 3) When you suddenly take a maneuver, press down firmly on the brakes **and ... in the direction you want to go and ... hard pressure on the ... .**
- 4) **The car has a very flexible engine with strong ... at low rpm so it's always ready to deliver smooth power.**
- 5) **The technical features of this 5,789 cc ... are known to have a power output of 367 ps (270 kW) at 5,500 rpm and an impressive torque of 530 Nm.**
- 6) **The five-speed automatic transmission shifts ... .**

9 points

**4. Переведите предложения на русский язык, обращая внимание на перевод инфинитива.**

- 1) There remains one more test to be carried out before using the device.
- 2) Emissions for the engine comply with Euro 4 is concluded to be introduced next year.
- 3) The radar detects the stationary objects ahead of the car to warn the driver about the danger and slow down the speed.
- 4) Diesel sales are expected to make up some 70 percent of Superb sales.
- 5) The cylinder liners are reported to provide additional weight savings up to 46 percent compared with the previous V12 engine.
- 6) Infrared rays emitted by any object on the road are to be intensive enough for sensors to pick them up.

6 points

**5. Переведите предложения на английский язык.**

- 1) Гильза цилиндра, как известно, сделана из специального сплава алюминия и кремния.
- 2) Каждый блок цилиндров имеет 2 поперечно расположенных катализатора.
- 3) Lexus SC 430 – плавный, тихий и мощный, и стоит значительно меньше, чем другие автомобили этого класса.
- 4) Пятискоростная автоматическая коробка передач переключается плавно.

- 5) Оказывается, новый двигатель управляется инновационной системой зажигания переменного тока.
- 6) Lexus SC 430 имеет надежные ремни безопасности.

6 points

Total score: 35 points

## Intermediate Lexical-Grammar Test

**(К пособию по практическому курсу научно-технического перевода для студентов технических специальностей автотракторного факультета Units 11-12, Variant 1)**

### **1. Переведите слова в скобках на английский язык и поставьте их в нужную форму.**

- 1) The new Beetle also has sensitive wipers, cruise control, (складнойключ) with remote control, (фильтрытонкойочистки) and rear – reading lights.
- 2) The warranty for (тормозныеколодки) is for the first 12 months .
- 3) At present sophisticated electronics is playing a big role in (современныхисследованиях).
- 4) The red light and (звуковойсигнал) on the instrument panel warn that the speed should go down.
- 5) The word (“сцепление”) indicates a device attached to cars having changed speed gears of the sliding type.
- 6) The Lexus is not intended to be driven like (гоночныйавтомобиль).

7 points

### **2. Выберите правильный вариант перевода предложений.**

- 1) He had to carry large cans of fuel, for there were no filling stations to refuel the car.
  - j) Он постоянно носил с собой большие канистры с бензином, так как не было заправочных станций, чтобы заправить машину
  - к) Ему приходилось возить с собой канистры с топливом, так как не было заправочных станций, чтобы заправить машину.
  - l) У него было много канистр с топливом для заправки машины, так как не было заправочных станций.
- 2) The new 2 – litre petrol engine, developed at the plant in Sweden is 15 kg lighter than its predecessor.
  - m) Новый двухлитровый бензиновый двигатель, разработанный на заводе в Швеции, весит 15 кг, как и его предшественник.
  - n) Новый двухлитровый бензиновый двигатель, разработанный на заводе в Швеции, весит на 15 кг легче, чем его предшественник.
  - o) Новый двухлитровый двигатель, который весит на 15 кг легче, чем предыдущий двигатель, способствовал строительству завода в Швеции.
- 3) I noted the new Beetle to exhibit excellent driving performance.
  - p) Я обратил внимание, что новый Beetle демонстрирует превосходные эксплуатационные характеристики.

- q) Я обратил внимание на новый Beetle, который демонстрирует превосходные эксплуатационные характеристики.
- r) Я записал, что новый Beetle демонстрирует превосходные эксплуатационные характеристики.

3 points

**3. Заполните пропуски выделенными словами**

Engine, wipers, brakes pads, internal combustion engine, folding key, clutch, brakes

- 1) The cars of that time were very small, the ... being placed under the seat.
- 2) ... having become more efficient, cars achieved greater reliability.
- 3) The word ... indicates a device attached to cars having changed speed gears of the sliding type.
- 4) It also has speed – sensitive ... , ... , cruise control.
- 5) The warranty for ... is for the first 12 months.
- 6) The first electrical cars were built at the end of the 19<sup>th</sup> century, but they could not compete against the ... .

7 points

**4. Переведите предложения на русский язык, обращая внимание на перевод причастия и «сложного дополнения».**

- 1) The car automatically adjusts the clearance, lowering the vehicle at high speeds.
- 2) I assumed these automatically to prevent the front driving wheels from spinning in slippery conditions.
- 3) I consider a 5 – year transferable powertrain warranty to be also standard.
- 4) The system being tested will increase the safety and fuel efficiency of a car.
- 5) A defect undetected caused an accident.
- 6) Clutch is a device which permits the engine to be connected with, or disconnected from, the transmission mechanism.

6 points

**5. Переведите предложения на английский язык**

- 1) Машина разработана согласно потребностям молодых семей, ведущих активный образ жизни.
- 2) Новый Beetle демонстрирует очень небольшой крен на поворотах.



- 3) Оптимальная 4х ступенчатая автоматическая коробка передач переключается легким нажатием.
- 4) Сцепление – это сила, которая препятствует, например, скольжению колеса по поверхности.
- 5) Разработав дизайн этого автомобиля, инженеры приступили к ряду тестов.
- 6) Новый Eclipse автомобили появились на мотошоу, стартуя в цене от 20 000 долларов США.

6 points

Total score: 29 points

## Intermediate Lexical-Grammar Test

**(К пособию по практическому курсу научно-технического перевода для студентов технических специальностей автотракторного факультета Units 11-12, Variant 2)**

### **1. *Переведите слова в скобках на английский язык и поставьте их в нужную форму.***

- 1) The 1,8TGLX adds (стеклоочистители, реагирующие на дождь), heated washer (форсунки стеклоомывателя) and (самозатемняющееся) rear mirrors.
- 2) The New Beetle exhibits excellent (амортизирующие характеристики).
- 3) It also has (складной ключ) with remote control, (фильтры тонкой очистки) and rear – reading lights.
- 4) The warranty for (тормозные колодки) is for the first 12 months.
- 5) Careful design of body panels and joins is the best starting point for (предотвращение коррозии).
- 6) The (паровой двигатель) has been invented in 1825.

9 points

### **2. *Выберите правильный вариант перевода предложений.***

- 1) Scientists are testing a system allowing drivers to see better after dark.
  - s) Ученые проверяют систему, которая заставляет водителей быть внимательнее с наступлением темноты.
  - t) Ученые проверяют систему, позволяющую водителям видеть лучше с наступлением темноты.
  - u) Ученые проверяют систему, которая помогает водителям ездить в темноте.
- 2) For corrosion resistance the following items should be considered by the designer.
  - v) Что касается устойчивости к коррозии, то дизайнер должен учесть следующие пункты.
  - w) Для коррозионной устойчивости дизайнер должен учесть следующие факторы.
  - x) Несмотря на устойчивость к коррозии, дизайнер должен учитывать следующие пункты.
- 3) In spite of the car having the larger engine, the price of a new model has remained unchanged.
  - y) У машины, имеющий больший двигатель, цена осталась неизменной, несмотря на то, что это новая модель.
  - z) Несмотря на то, что у машины больший двигатель, цена новой модели не изменилась.

- a) **Цена новой машины, имеющей большой двигатель, не изменилась.**

3 points

3. ***Заполните пропуски выделенными словами***

Buzzer, safety, highways, radar, right vision system, traffic, clutch

- 1) **The ... used was of a completely new design.**
- 2) **The ... uses a unique camera that can be placed close to the driver\*s head.**
- 3) **The red light and ... on the instrument panel warn that the speed should go down.**
- 4) **To insure maximum ... for the transportation system, it is necessary to plan and design ... on sound engineering techniques.**
- 5) Modern roads should be designed according to the anticipated volume and speed of the ... .
- 6) **... is a device which permits the engine to be connected with or disconnected from the transmission mechanism.**

7 points

4. ***Переведите предложения на русский язык, обращая внимание на перевод независимого причастного оборота и и «сложного дополнения».***

- 1) I also found standard equipment on the GLS model to include the turbocharger.
- 2) The steam engine having been invented in 1825, a self-propelled vehicle was built.
- 3) Brakes having become more efficient , cars achieved greater reliability.
- 4) I assumed these automatically to prevent the front driving wheels from spinning.
- 5) Until now, Jaguar station wagons were relatively rare, appearing only as the result of modifications, performed by British companies such as Lynx.
- 6) A new electronic instrument calculates how far one can drive on the fuel left in the tank.

6 points

**5. *Переведите предложения на английский язык***

- 1) Мы думаем, что нужно использовать эти сплавы для производства подшипника.
- 2) К 1960 году число машин в мире достигло 60 миллионов.
- 3) В то время машины были слишком маленькие, так как двигатель был помещен под сидение.
- 4) Клапанный механизм состоит из клапанов и механизмов, которые открывают и закрывают их.
- 5) Расстояние до впереди движущегося средства рассчитывается и затем отображается на экране.
- 6) Хотя радар был разработан для военных целей, его успешно используют в современных машинах.

6 points

Total score: 31 points

## Final Test

(К пособию по практическому курсу научно-технического перевода для студентов технических специальностей автотракторного факультета, Variant 1)

Time: 90 minutes

***Выполните письменный перевод следующего текста.***

Since being introduced, Electronic stability control (ESC) has received numerous accolades for its ability to reduce vehicle crashes by decreasing skidding and improving vehicle stability. An important aspect of ESC is its ability to work in conjunction with other safety applications. Rollover mitigation (ROM) is one example of this flexibility at work. Through existing ESC sensors, ROM can help reduce rollover risk by determining when a vehicle is experiencing extreme lateral tire forces, and activate to reduce those forces. Additionally, trailer sway mitigation uses existing ESC system components to prevent unstable oscillations and trailer sway through brake interventions on the tow vehicle.

Looking further into the future, it is evident that ESC will serve as a gateway for other important safety systems. The range of data ESC provides can significantly influence the performance of technologies such as adaptive cruise control (ACC), airbags, collision mitigation, and automatic emergency brake systems. For example, while ACC can theoretically function without ESC, when ESC data is provided, the performance and benefits of ACC are expanded for the driver. Specifically, ESC provides an increased deceleration capability through active braking without sacrificing vehicle stability. Additionally, in the event of an emergency braking situation, ESC allows the vehicle to maximize braking, which in the future will assist collision-mitigation technologies in avoiding an accident or at least minimizing the effects of a collision.

Likewise, as ESC helps to maximize braking scenarios, it can also interact with airbags to result in more effective deployments. ESC has the ability to act as an early indicator, communicating to the airbags that a vehicle is in an unstable condition (such as sliding sideways). By pre-arming the airbags with more comprehensive data, the airbags are then able to deploy more quickly and accurately.

Not only does performance improve when controllers from one system are able to communicate with controllers of another system, but this interaction also provides a way to reduce costs for automakers. Defining a worldwide industry standard for basic functions and interfaces in every automotive electronic control unit is a necessity to ensure the effective application of these future, system-to-system interfaces. This common standard is also the only way the industry is truly making the shift from thinking about vehicle safety in terms of crash avoidance, which ultimately saves more lives. And ESC is a key starting point for this growth in system-to-system interface.

## Final Test

(К пособию по практическому курсу научно-технического перевода для студентов технических специальностей автотракторного факультета, Variant 2)

Time: 90 minutes

***Выполните письменный перевод следующего текста.***

The future of commercial vehicles is a subject of many automakers. Today, they are more convinced than ever that focusing on diesel is a smart decision, and that the leading engine technology for the foreseeable future, indeed for the 21st century, will be diesel.

Today's diesel has 98% lower emissions than it did before regulation, and diesel engines in trucks and school buses can be as clean or cleaner than engines powered by any other fuel. The path to low-emitting diesel technology is called International Green Diesel Technology, which combines efficient, high-tech engines that use fuel even more efficiently (and actually start the emissions clean-up in the cylinder); advanced aftertreatment that captures and burns emissions before they escape; and ultra-low-sulfur (ULS) diesel that lets the aftertreatment work, similar to the way that removing lead from gasoline enabled catalytic converters to work in passenger cars.

In fact, diesel has already proven to be the preferred solution for consumers, business, environmentalists, school districts, and the military. From school buses to ambulances to an increasing number of passenger vehicles, the vehicles that people depend on are diesel-powered.

Diesel is already the solution for virtually all heavy-duty trucks and almost all medium-duty trucks. Heavy-duty pickup owners are now switching to diesel. With the technology and new fuel widely available, this trend include diesel in SUVs and light pickups.

Diesel offers immediate advantages over any other power source. New low-emitting diesel vehicles (such as school buses) are just as clean, if not cleaner, than those using natural gas. Hydrogen fuel cells sound exciting, but are decades away. By contrast, within a short time frame, diesel offers the following opportunities:

- To reduce the cost per mile traveled;
- To reduce imports of foreign oil;
- To reduce CO<sub>2</sub> emissions.

When you consider all these advantages, it's clear that governments need to do everything possible to provide incentives to help commercial vehicles make the transition to low-emitting diesel.

**Белорусский национальный технический университет**

**УТВЕРЖДАЮ**

Декан факультета горного дела и инженерной экологии

\_\_\_\_\_ П.В. Цыбуленко

" \_\_\_\_ " \_\_\_\_\_ 2011 г.

Регистрационный № УД-ФГДЭ 08-\_\_\_/р.

**ИНОСТРАННЫЙ ЯЗЫК (АНГЛИЙСКИЙ)**

**Учебная программа для технических и инженерно-экономических специальностей БНТУ  
(дневная форма получения образования)**

Факультет горного дела и инженерной экологии

Кафедра «Английский язык №1»

Курсы – 1, 2

Семестры – 1, 2, 3, 4

Экзамен – 4 семестр

Практические занятия – 150 часов

Зачет – 1, 2, 3 семестры

Всего аудиторных часов по дисциплине – 150

Всего часов по дисциплине – 308

Форма получения высшего образования – дневная

Составили **С.А. Хоменко**, заведующая кафедрой «Английский язык №1», кандидат филологических наук, доцент, **С.П. Личевская**, старший преподаватель

Учебная программа составлена на основе типовой учебной программы дисциплины «Иностранный язык» для высших учебных заведений, утвержденной Министерством образования Республики Беларусь 15 апреля 2008 года. Регистрационный №ТД-СГ.013/тип.

Рассмотрена и рекомендована к утверждению в качестве рабочего варианта на заседании кафедры «Английский язык №1» Белорусского национального технического университета  
(протокол № 1 от 26.09.2011 г.)

Заведующая кафедрой

С.А. Хоменко

Одобрена и рекомендована к утверждению Советом факультета горного дела и инженерной экологии Белорусского национального технического университета  
(протокол № 1 от 26.09 2011 г.)

Председатель Совета

П.В. Цыбуленко



## ПОЯСНИТЕЛЬНАЯ ЗАПИСКА

Иноязычная подготовка рассматривается как составная часть вузовской программы гуманитаризации высшего образования, как средство формирования профессиональной компетентности специалистов технического профиля, активно владеющих иностранным языком для осуществления межкультурной коммуникации как в сферах профессиональных интересов, так и в ситуациях социокультурного общения.

Учебная программа дисциплины “Иностранный язык (английский)” разработана для студентов технических и инженерно-экономических специальностей Белорусского национального технического университета дневной формы получения образования.

Особенностью настоящей программы является компетентностный подход, усиление практико-ориентированной составляющей, направленность на развитие коммуникативной компетенции будущего специалиста в предполагаемых сферах его профессиональной деятельности.

Иноязычная подготовка осуществляется в соответствии с принципами единства целей, методов и технологий обучения иностранному языку; сочетания практической направленности с систематизацией языкового и речевого материала в сознании обучаемых; соединения активной коммуникативности с сознательно-сопоставительным анализом родного и изучаемого языков и опоры на речевой опыт обучаемых; системности в организации взаимосвязанного обучения всем видам речевой деятельности; эффективного управления контролируруемыми и самостоятельными формами работы; интенсификации учебного процесса на основе активизации речемыслительной деятельности студентов; аутентичности в отборе и организации учебных материалов; соизучения языка и культуры; индивидуализации обучения; использования аудиовизуальных и информационных технологий.

Предлагаемая программа – один из вариантов стратегии преподавания иностранного языка в условиях неязыковых специальностей. Она формирует цель обучения, структуру курса и задачи обучения, указывает на характер языкового и речевого учебного материала, на формы текущего и итогового контроля, включая некоторые количественные параметры.

### 1.1 Цели и задачи обучения

**Главная цель** обучения – формирование иноязычной коммуникативной компетенции будущего специалиста, позволяющей использовать иностранный язык как средство профессионального и межличностного общения.

Достижение главной цели предполагает комплексную реализацию ряда целей.

**Практическая цель** предполагает формирование у студентов лингвистической (языковой), речевой, профессиональной, социокультурной, компенсаторной, учебно-познавательной компетенций.

*Лингвистическая (языковая) компетенция* – это совокупность языковых средств (фонетических, лексических, грамматических), а также правил их использования в коммуникативных целях.

*Речевая компетенция* включает совокупность навыков и умений речевой деятельности (говорение, письмо, аудирование, чтение), знание норм речевого поведения, способность использовать языковые средства в связной речи в соответствии с ситуацией общения.

*Профессиональная компетенция*, которая является частью речевой, заключается в овладении умениями профессионально-ориентированного иноязычного общения в предполагаемых ситуациях производственной, научной деятельности, а также в ознакомлении с зарубежным опытом в соответствующей области знаний.

*Социокультурная компетенция* понимается как совокупность фоновых знаний, принятых норм поведения в странах изучаемого языка и связанных с ними умений корректно осуществлять свое речевое и неречевое поведение.

*Компенсаторная компетенция* – совокупность умений использовать дополнительные вербальные средства и невербальные способы решения коммуникативных задач в условиях дефицита имеющихся языковых средств.

*Учебно-познавательная компетенция* – совокупность общих и специальных учебных умений, необходимых для осуществления самостоятельной деятельности по овладению иностранным языком.

**Познавательная цель.** Образование средствами иностранного языка способствует расширению общего кругозора студентов, позволяет сформировать представление о мире как о целостной многоуровневой системе (языковой, социокультурной и т.п.), об особенностях профессиональной деятельности в соизучаемых странах.

**Воспитательная цель** предполагает формирование общенациональных и личностных ценностей, гуманистического отношения к миру, культуры мышления, поведения, общения, потребности в дальнейшем самообразовании и самовоспитании. Также существенным является формирование уважения к другим культурам.

**Развивающая цель** направлена на раскрытие познавательных, интеллектуальных и языковых способностей студентов, совершенствование механизмов оперативной и долговременной памяти, вероятностного прогнозирования, формирование языковой догадки и умения переноса знаний и навыков в новую ситуацию, формирование потребности к самостоятельной познавательной деятельности.

Теоретические исследования процесса овладения иностранным языком, весь практический опыт преподавания позволяют утверждать, что путь к конечной цели должен быть маркирован промежуточными **задачами** обучения, которые формируются следующим образом:

- переориентировать студентов в психологическом плане и практически с понимания иностранного языка лишь как внешнего источника информации и иноязычного средства коммуникации на усвоение и

использование иностранного языка для выражения собственных высказываний и понимания других людей;

- подготовить студентов к естественной коммуникации в устной и письменной формах иноязычного общения;
- научить студентов видеть в иностранном языке средство получения, расширения и углубления системных знаний по специальности и средство самостоятельного повышения своей профессиональной квалификации.

### 1.2 Общие требования к уровню освоения содержания

В результате изучения дисциплины студент должен **знать**:

- особенности системы изучаемого иностранного языка в его фонетическом, лексическом и грамматическом аспектах (в сопоставлении с родным языком);
- социокультурные нормы бытового и профессионального общения, а также правила речевого этикета, позволяющие специалисту эффективно использовать иностранный язык как средство общения в современном поликультурном мире.

Студент должен **уметь**:

- вести общение социокультурной и профессиональной направленности в объеме, предусмотренном настоящей программой;
- читать и переводить литературу по специальности (изучающее, ознакомительное, просмотровое, поисковое чтение);
- письменно выражать свои коммуникативные намерения в сферах, предусмотренных настоящей программой;
- понимать аутентичную речь на слух в объеме программной проблематики.

### 1.3 Требования к практическому владению видами речевой деятельности

В результате изучения дисциплины студент должен **приобрести** следующие умения:

#### **Рецептивные умения**

##### *Аудирование*

Студент должен уметь

- воспринимать на слух иноязычную речь в естественном темпе (аутентичные монологические и диалогические тексты профессионально-ориентированной направленности) с разной полнотой и точностью понимания их содержания;
- воспроизводить услышанное при помощи повторения, перефразирования, пересказа.

Учебные аудио- и видеотексты могут включать до 5% незнакомых слов, не влияющих на понимание основного содержания.

##### *Чтение*

Студент должен уметь:

- владеть всеми видами чтения (изучающее, ознакомительное, просмотровое, поисковое), предполагающими разную степень понимания прочитанного;
- полно и точно понимать содержание разножанровых аутентичных текстов, в том числе, профессионально ориентированных, используя двуязычный словарь (изучающее чтение);
- понимать общее содержание текста (70%), определять не только круг затрагиваемых вопросов, но и то, как они решаются (ознакомительное чтение);
- получать общее представление о теме, круге вопросов которые затрагиваются в тексте (просмотровое чтение);
- найти конкретную информацию (определение, правило, цифровые и другие данные), о которой заранее известно, что она содержится в данном тексте (поисковое чтение).

Тексты, предназначенные для просмотрового, поискового и ознакомительного чтения, могут включать до 10% незнакомых слов.

## **Продуктивные умения**

### ***Говорение***

#### *Монологическая речь*

Студент должен уметь:

- продуцировать развернутое подготовленное и неподготовленное высказывание по проблемам социокультурного и профессионального общения, перечисленным в настоящей программе;
- резюмировать полученную информацию;
- аргументированно представлять свою точку зрения по описанным фактам и событиям, делать выводы.
- Примерный объем высказывания – 15 фраз.

#### *Диалогическая речь*

Студент должен уметь:

- вступать в контакт с собеседником, поддерживать и завершать беседу, используя адекватные речевые формулы и правила речевого этикета;
- обмениваться профессиональной и непрофессиональной информацией с собеседником, выражая согласие/несогласие, сомнение, удивление, просьбу, совет предложение и т.п.;
- участвовать в дискуссии по теме /проблеме, аргументированно отстаивать свою точку зрения.

Примерное количество реплик – 8-10 с каждой стороны.

### ***Письмо***

Студент должен уметь:

- выполнять письменные задания к прослушанному, увиденному, прочитанному, логично и аргументированно излагать свои мысли, соблюдая стилистические и жанровые особенности;

- владеть навыками составления частного и делового письма, правильно использовать соответствующие реквизиты и формулы письменного общения;
- реферировать и аннотировать профессионально ориентированные и общенаучные тексты с учетом разной степени смысловой компрессии.

#### 1.4 Структура курса

В соответствии с действующими учебными планами специальностей в БНТУ на курс обучения английскому языку предусматриваются обязательные аудиторные занятия в I-IV семестрах в объеме 150 часов и 158 часов самостоятельной работы. Распределение учебных часов по годам обучения:

I вариант

1 год	I семестр	34 часа	зачет
	II семестр	34 часа	зачет
2 год	III семестр	34 часа	зачет
	IV семестр	34 часа	экзамен
		136 часов	14 часов
150 часов			

II вариант

1 год	I семестр	68 часов	зачет
	II семестр	68 часов	экзамен
		136 часов	14 часов
150 часов			

#### 1.5 Технологии обучения, рекомендуемые к использованию в процессе обучения иностранному языку (английскому)

Для вовлечения студентов в поиск и управление знаниями, а также для приобретения опыта самостоятельного решения речемыслительных задач рекомендуется использовать в учебном процессе следующие инновационные технологии обучения:

- *проектную технологию*, представляющую самостоятельную, долгосрочную групповую работу по теме, выбранной студентами в рамках изучаемой проблематики;
- *кейс-технологию*, в основе которой лежат осмысление, критический анализ и решение конкретных социальных проблем, с которыми студенты непосредственно сталкиваются в жизни;
- *симуляцию*, которая представляет собой подражательное, разыгранное воспроизведение межличностных контактов, организованных вокруг проблемной ситуации, максимально приближенной к реальной;

- коммуникативные технологии *мозгового штурма, дискуссии, пресс-конференции, презентации*;
- *компьютерные технологии*, предполагающие широкое использование Интернет-ресурсов и мультимедийных обучающих программ.

### 1.6 Организация самостоятельной работы студентов

Обучение английскому языку в техническом университете предполагает следующие формы самостоятельной работы:

- индивидуальная самостоятельная аудиторная работа под контролем преподавателя;
- обязательная самостоятельная работа студентов по заданию преподавателя, выполняемая во внеаудиторное время, в том числе с использованием технических средств обучения.

В соответствии с действующими учебными планами специальностей в БНТУ на курс обучения английскому языку предусматриваются 158 часов самостоятельной работы.

Основной целью самостоятельной работы студентов является закрепление, углубление и совершенствование полученных знаний, навыков и умений, т.е. достижение соответствующего уровня иноязычной компетентности за период обучения.

Для достижения данной цели самостоятельная работа студентов должна носить систематический и непрерывный характер. Организацию самостоятельной работы студентов следует осуществлять с учетом особенностей различных видов речевой деятельности.

#### I семестр

Аудиторная самостоятельная работа под непосредственным контролем преподавателя должна составлять 20 % от общего числа учебных часов на данный семестр, т.е. 6 часов. Внеаудиторная самостоятельная работа должна составлять 34 часа.

Основное назначение самостоятельной работы студентов на данном этапе – формирование навыков и умений применения полученных знаний. На данном этапе самостоятельная работа студентов должна носить репродуктивный характер и предполагает самостоятельное выполнение заданий как на уровне воспроизведения, так и на уровне распознавания в простых стандартных ситуациях.

#### II семестр

Самостоятельная работа под руководством преподавателя должна осуществляться как способ реализации личностно-ориентированного подхода в обучении и должна составлять 20 % от общего числа учебных часов на данный семестр, т.е. 6 часов, и внеаудиторная самостоятельная работа – 40 часов.

Основное назначение самостоятельной работы студентов на данном этапе – формирование навыков и умений в различных видах речевой деятельности. На

данном этапе самостоятельная работа студентов должна носить как репродуктивный характер, так и частично-поисковый характер, что предполагает активную самостоятельную работу студентов в лингафонных кабинетах.

### **III семестр**

Самостоятельная работа под руководством преподавателя должна составлять 25% от общего числа учебных часов на данный семестр, т.е. 8 часов от общего числа учебных часов на данный семестр, и внеаудиторная работа – 44 часа.

На данном этапе самостоятельная работа студентов должна представлять собой частично-поисковый вид самостоятельной работы. Основная цель – закрепление изучаемых понятий и применение их в новых условиях. Основными видами являются:

- решение коммуникативно-познавательных задач;
- перевод текстов;
- задания по поиску информации по данному вопросу;
- подготовка к проведению деловой игры и т.д.

### **IV семестр**

Самостоятельная работа на данном этапе должна носить творческий характер и способствовать развитию творческого потенциала студента и должна составлять 15 % аудиторной самостоятельной работы под руководством преподавателя, т.е. 4 часа, и внеаудиторная самостоятельная работа – 40 часов.

Основная цель – формирование аналитических умений, стимулирование познавательной активности. Задания должны носить проблемный, эвристический, поисково-исследовательский характер. На данном этапе методами обучения должны стать установки, организующие и регулирующие самостоятельную работу студентов в читальных залах, библиотеках, компьютерных классах, в учебно-методических кабинетах.

## **2 СОДЕРЖАНИЕ ДИСЦИПЛИНЫ**

### **2.1 Предметно-тематическое содержание**

#### **2.1.1 Модуль социального общения**

##### **2.1.1.1 Социально-бытовое общение**

2.1.1.1.1 Личностные характеристики (биографические сведения, интересы).

##### **2.1.1.2 Социокультурное общение**

2.1.1.2.1 Социально-познавательная деятельность: жизнь студента (рабочий день, виды учебных занятий, общественная деятельность, досуг) и сравнение с жизнью студентов в стране изучаемого языка.

2.1.1.2.2 Системы образования. Типы учебных заведений в соизучаемых странах. Обучение в вузе.

2.1.1.2.3 Социокультурные нормы делового общения.

2.1.1.2.4 Выдающиеся представители науки и техники, их открытия.

#### **2.1.2 Модуль профессионального общения**

##### **2.1.2.1. Профессиональное общение**

2.1.2.1.1 Введение в специальность, ее предмет и содержание. Общее представление о структуре и характере профессиональной деятельности специалиста.

2.1.2.1.2 Посещение предприятий, соответствующих выбранной специальности, с целью ознакомления с будущей профессиональной деятельностью студента.

2.1.2.1.3 Обмен научно-технической информацией (на выставке, ярмарке, конференции).

2.1.2.1.4 Трудоустройство и карьера.

2.1.2.1.5 Типичные ситуации производственного общения.

2.1.2.1.6 Реферирование и аннотирование статьи по специальности



## 2.2. Виды речевой деятельности

*Аудирование* – умение воспринимать на слух иноязычную речь с разной полнотой и точностью понимания содержания, а также понимать разножанровые аудио- и видеотексты.

*Говорение* – умение осуществлять монологическое, диалогическое и полилогическое общение в соответствии с ситуацией и коммуникативной задачей с соблюдением норм речевого и неречевого этикета.

*Чтение* – умение владеть всеми видами чтения (изучающее, ознакомительное, просмотровое, поисковое), предполагающее разную степень понимания и смысловой компрессии разножанровых текстов.

*Письменная речь* – умение порождать различные виды письменных текстов (резюме, аннотации, анкеты, деловые письма) в соответствии с коммуникативной задачей и нормами, принятыми в странах изучаемого языка.

В учебном процессе предполагается взаимосвязанное обучение видам речевой деятельности, осуществляемое на предметно-тематическом материале курса.

## 2.3 Языковой материал

### 2.3.1 Фонетика

2.3.1.1 Звуковой строй иноязычной речи в сопоставлении с фонетической системой родного языка: особенности произнесения отдельных звуков (гласных, согласных), звукосочетаний, слов и фраз; расхождение между произношением и написанием; фонетическая транскрипция.

2.3.1.2 Интонационное оформление фраз различного коммуникативного типа: повествования, вопроса, просьбы, приказа, восклицания.

2.3.1.3 Фразовое и логическое ударение в сложном предложении.

### 2.3.2 Грамматика

2.3.2.1 *Морфология:*

2.3.2.1.1 Имя существительное: категории числа, падежа, определенности.

2.3.2.1.2 Имя прилагательное: категория степеней сравнения; сравнительные конструкции.

2.3.2.1.3 Местоимения: личные, притяжательные, указательные, вопросительные, неопределенные, возвратные.

2.3.2.1.4 Числительные: простые, производные и сложные, количественные, порядковые, дробные.

2.3.2.1.5 Наречие: классификация, категория степеней сравнения.

2.3.2.1.6 Глагол: видо-временная система, действительный и страдательный залог, модальные глаголы и их эквиваленты; согласование времен.

2.3.2.1.7 Неличные формы глагола: инфинитив, причастие, герундий и конструкции с ними.

2.3.2.1.8 Словообразовательные модели (существительное, прилагательное, наречие, глагол).

2.3.2.1.9 Сослагательное наклонение.

2.3.2.1.10 Служебные слова: предлоги, союзы, союзные слова.

*2.3.2.2 Синтаксис:*

2.3.2.2.1 Простое предложение: типы простых предложений; порядок слов; члены предложения, способы выражения подлежащего и сказуемого, правила их согласования, специфические конструкции и обороты.

2.3.2.2.2 Сложное предложение: сложносочиненное и сложноподчиненное, типы придаточных предложений; бессоюзное подчинение.

2.3.2.2.3 Прямая и косвенная речь: правила перевода в косвенную речь предложений разных типов.

2.3.2.2.4 Вводные слова и предложения.

### 2.3.3 Лексика

2.3.3.1 Наиболее употребительные слова и словосочетания по предметно-тематическому содержанию курса.

2.3.3.2 Сочетаемость слов, свободные и устойчивые словосочетания; общенаучная лексика и терминология.

2.3.3.3 Наиболее распространенные формулы-клише: знакомство, установление/поддержание контакта, выражение просьбы, согласия/несогласия с мнением автора/собеседника, начало, продолжение, завершение беседы, выражение собственного мнения, запрос о мнении собеседника, уверенность/неуверенность.

Объем лексического материала 1500 лексических единиц (продуктивно),  
из них 300- терминологическая лексика.

### 3 УЧЕБНО-МЕТОДИЧЕСКАЯ КАРТА

Номер раздела, темы, занятия	Название раздела, темы, занятия; перечень изучаемых вопросов	Количество аудиторных часов		Материальное обеспечение занятия (наглядные, методические пособия и др.)	Литература	Формы контроля знаний
		практические занятия	управляемая (контролируемая) самостоятельная работа студентов			
1.	<b>Иностранный язык (английский) (308 ч.)</b>	150	158		[1] - [22]	
1.1	<b>1 семестр</b>					
1.1.1	<b>Предметно-тематическое содержание</b>	12	10		[1] - [22]	
1.1.1.1	Социально-бытовое общение					
1.1.1.1.1	Личностные характеристики (биографические сведения, интересы)	2				
1.1.1.2	Социокультурное общение					
1.1.1.2.1	Социально-познавательная деятельность: жизнь студента (рабочий день, виды учебных занятий, общественная деятельность, досуг). Сравнение с жизнью студентов в стране изучаемого языка	6	6			
1.1.1.2.2	Выдающиеся представители науки и техники, их открытия	4	4			
1.1.2	<b>Языковой материал</b>	22	24			
1.1.2.1	Фонетика					
1.1.2.1.1	Звуковой строй иноязычной речи в сопоставлении с фонетической системой родного языка: особенности произнесения отдельных звуков (гласных, согласных), звукосочетаний, слов и фраз; расхождение между	2	4	аудиозапись		

	произношением и написанием; фонетическая транскрипция					
1.1.2.2.	Грамматика					
1.1.2.2.1	Имя существительное: категории числа, падежа, определенности	2			грамматический справочник	
1.1.2.2.2	Имя прилагательное: категория степеней сравнения, сравнительные конструкции	2			грамматический справочник	
1.1.2.2.3	Местоимения: личные, притяжательные, указательные, вопросительные, неопределенные, возвратные	2	2		грамматический справочник	
1.1.2.2.4	Наречие: классификация, категория степеней сравнения	2	2		грамматический справочник	
1.1.2.2.5	Числительные: простые, производные и сложные, количественные, порядковые, дробные	2	2		грамматический справочник	
1.1.2.2.6	Глагол: видо-временная система (действительный залог)	2	4		грамматический справочник	лексико- грамматич еский тест
1.1.2.3	Лексика					
1.1.2.3.1	Наиболее употребительные слова и словосочетания по предметно- тематическому содержанию курса	4	6		словарь	лексико- грамматич еский тест
1.1.2.3.2	Этикетные клише: знакомство, установление/поддержание контакта, выражение просьбы, согласия/несогласия с мнением автора/собеседника	2	4			
	<b>Итого за семестр</b>	34	34			
2.1	<b>2 семестр</b>					
2.1.1.	<b>Предметно-тематическое</b>	8	8			[1] - [22]

	<b>содержание</b>					
2.1.1.1	Социокультурное общение					
2.1.1.1.1	Системы образования. Типы учебных заведений в соизучаемых странах. Обучение в вузе	8	8			
2.1.2	<b>Языковой материал</b>	26	32			
2.1.2.1	Фонетика					
2.1.2.1.1	Интонационное оформление фраз различного коммуникативного типа: повествования, вопроса, просьбы, приказа, восклицания	2	2	аудиозапись		
2.1.2.2	Грамматика					
2.1.2.2.1	Глагол: видо-временная система (страдательный залог); модальные глаголы и их эквиваленты; согласование времен	6	8	грамматический справочник		лексико-грамматический тест
2.1.2.2.2	Простое предложение: типы простых предложений; порядок слов; члены предложения, способы выражения подлежащего и сказуемого, правила их согласования, специфические конструкции и обороты	4	6	грамматический справочник		
2.1.2.2.3	Прямая и косвенная речь: правила перевода в косвенную речь предложений разных типов	4	6	грамматический справочник		лексико-грамматический тест
2.1.2.3	Лексика					
2.1.2.3.1	Сочетаемость слов, свободные и устойчивые словосочетания; общенаучная лексика и терминология	8	6	словарь		
2.1.2.3.2	Этикетные клише: начало, продолжение, завершение беседы, выражение собственного мнения,	2	4			

	запрос о мнении собеседника, уверенность/неуверенность					
	<b>Итого за семестр</b>	34	40			
3.1	<b>3 семестр</b>					
3.1.1.	<b>Предметно-тематическое содержание</b>	10	16		[1] - [22]	
3.1.1.1	Социокультурное общение					
3.1.1.1.1	Социокультурные нормы делового общения	2	4			
3.1.1.2	Профессиональное общение					
3.1.1.2.1	Введение в специальность, ее предмет и содержание. Общее представление о структуре и характере профессиональной деятельности специалиста	2	4			
3.1.1.2.2	Посещение предприятий, соответствующих выбранной специальности, с целью ознакомления с будущей профессиональной деятельностью студента	2	4			
3.1.1.2.3	Типичные ситуации производственного общения	4	4			
3.1.2	<b>Языковой материал</b>	24	28			
3.1.2.1	Фонетика					
3.1.2.1.1	Фразовое и логическое ударение в сложном предложении	2	2	аудиозапись		
3.1.2.2	Грамматика					
3.1.2.2.1	Неличные формы глагола: инфинитив, причастие, герундий и конструкции с ними	10	6	грамматический справочник		лексико-грамматический тест
3.1.2.2.2	Словообразовательные модели (существительное, прилагательное,	2	4	грамматический справочник		

	наречие, глагол)					
3.1.2.2.3	Сложное предложение: сложносочиненное и сложноподчиненное, типы придаточных предложений; бессоюзное подчинение	2	6	грамматический справочник		
3.1.2.3	Лексика					
3.1.2.3.1	Наиболее употребительные слова и словосочетания по предметно-тематическому содержанию курса	4	4			
3.1.2.3.2	Терминологическая лексика	4	6	словарь		лексический тест
	<b>Итого за семестр</b>	34	44			
4.1	<b>4 семестр</b>					
4.1.1.	<b>Предметно-тематическое содержание</b>	14	16		[1] - [22]	
4.1.1.1	Профессиональное общение					
4.1.1.1.1	Обмен научно-технической информацией (на выставке, ярмарке, конференции)	4	4			
4.1.1.1.2	Трудоустройство и карьера	4	4			
4.1.1.1.3	Реферирование и аннотирование статьи по специальности	6	8			
4.1.2.	<b>Языковой материал</b>	20	24			
4.1.2.1	Грамматика					
4.1.2.1.1	Сослагательное наклонение	4	6	грамматический справочник		лексико-грамматический тест
4.1.2.1.2	Служебные слова: предлоги, союзы, союзные слова	2	6	грамматический справочник		
4.1.2.1.3	Вводные слова и предложения	2	2	грамматический справочник		
4.1.2.2	Лексика					



4.1.2.2.1	Наиболее употребительные слова и словосочетания по предметно-тематическому содержанию курса	6	4			
4.1.2.2.2	Терминологическая лексика	6	6	словарь		лексический тест
5.1	<b>Модуль контроля</b>	14				зачет, экзамен
	<b>Итого за семестр</b>	34	40			
	<b>ВСЕГО</b>	308				

## 4 ИНФОРМАЦИОННО-МЕТОДИЧЕСКАЯ ЧАСТЬ

### 4.1 Средства диагностики компетенций студента (Модуль контроля)

Контроль уровня сформированности коммуникативной компетенции проводится в форме текущего, промежуточного (2 лексико-грамматические теста по пройденному языковому материалу и 2 контрольных перевода) и итогового контроля. В I, II и III семестрах итоговый контроль включает проведение зачетов, а в IV семестре проводится экзамен согласно I варианту, либо в I семестре проводится зачет, а во II семестре экзамен согласно II варианту реализации учебной программы.

#### Содержание экзамена:

1. чтение текста объемом 1200-1400 печатных знаков, письменный перевод 1200 печ. знаков (со словарем) (45 мин.); форма контроля – чтение текста на иностранном языке вслух (выборочно) и проверка выполненного перевода;
2. реферативное изложение текста объемом 2000 печатных знаков, ответы на вопросы преподавателя по содержанию прочитанного (15 мин.);
3. ситуативно-обусловленная беседа по изученной проблематике.

### 4.2 Учебные материалы

В учебном процессе используются учебные пособия по специальностям факультетов университета, оригинальные тексты из иноязычных общетехнических и специальных изданий, аудио- и видеоматериалы, образцы заполнения анкет и писем, словари и справочники.

### 4.3 Литература

#### Основная

1. Английский язык для студентов технических вузов: основной курс. Basic English for Technical Students / С.А. Хоменко [и др.]; под общ. ред. С.А. Хоменко, В.Ф. Скалабан. – Минск: Вышэйшая школа, 2004. В 2 ч. – 494 с.
2. Боярская, А.О. Пособие по практическому курсу научно-технического перевода для студентов технических специальностей автотракторного факультета / А.О.Боярская, С.Д. Симонова, Е.В. Слесаренок. – Минск, 2006. – 104 с.
3. Боярская, А.О. English for Transportation. Пособие по английскому языку для специалистов по организации перевозок / А.О. Боярская, Л.В. Педько, Е.В. Слесаренок. – Минск, 2009. – 111 с.
4. Иванович, Л.А. Информационные технологии и робототехника. Пособие по практическому курсу научно-технического перевода для студентов 2 курса факультета информационных технологий и робототехники / Л.А. Иванович, Т.Н. Лапицкая, Л.А. Любавина. – Минск, 2006. – 90 с.
5. Кипнис, И.Ю. Learn to Translate. Пособие для обучения переводу английских научно-технических текстов студентов II курса

- машиностроительного факультета / И.Ю. Кипнис, Л.В. Педько, Ю.В. Безнис. – Минск, 2006. – 178 с.
6. Кипнис, И.Ю. Учебно-методическое пособие по переводу английских научно-технических текстов для студентов II и III курсов машиностроительного факультета специальностей «Интеллектуальные приборы» и «Интегральные сенсорные системы» / И.Ю. Кипнис, Л.В. Педько, Ю.В. Безнис. – Минск, БНТУ, 2005. – 102 с.
  7. Кипнис, И.Ю. Грамматические особенности перевода английского научно-технического текста. Грамматический справочник / И.Ю. Кипнис, С.А. Хоменко. – Минск, 2010. – 121 с.
  8. Кипнис, И.Ю. English for Computer Science Students. Пособие по английскому языку для студентов, изучающих компьютерные технологии / И.Ю. Кипнис, Ю.В. Безнис, С.А. Хоменко. – Минск, 2009. – 103 с.
  9. Лазаренко, А.М. Сосредоточьтесь на экономике. Учебное пособие для студентов экономических специальностей технических вузов / А.М. Лазаренко. – Минск, 2003. – 207 с.
  10. Learning to Talk Shop. Профессиональное общение на английском языке / С.В. Острейко [и др.]; под общ. ред. С.А. Хоменко, В.Ф. Скалабан. – Минск, 2007. – 162 с.
  11. Let's Revise English. Пособие для подготовки к поступлению в магистратуру / С.А. Хоменко [и др.]; под общ. ред. С.А. Хоменко, В.Ф. Скалабан. – Минск, 2007. – 140 с.
  12. Луговая, А.Л. Английский язык для энергетических специальностей / А.Л. Луговая. – М., 2001.
  13. Методическое пособие по английскому языку для студентов II курса МТФ / Р.С. Молочко [и др.]. – Минск, 1990.
  14. Острейко, С.В. Пособие по практическому курсу научно-технического перевода для студентов энергетического факультета / С.В. Острейко, А.М. Силицкая. – Минск, 2008. – 91 с.
  15. Пискун, О.Ф. English for Military Students. Пособие для студентов военно-технического факультета / О.Ф. Пискун, С.А. Хоменко. – Минск, БНТУ, 2006. – 172 с.
  16. Савицкая, Т.В. Технология и оборудование ювелирного производства. Пособие по практическому курсу научно-технического перевода для студентов приборостроительного факультета / Т.В. Савицкая, Д.Ю. Комиссарова. – Минск, БНТУ, 2006. – 88 с.
  17. Tests in the Use of Technical English / С.А. Хоменко [и др.]; под общ. ред. С.А. Хоменко, В.Ф. Скалабан. – Минск: Амалфея, 2003. – 240 с.
  18. Хоменко, С.А. Brush up your English / С.А. Хоменко, В.Ф. Скалабан, А.И. Гресь. – Минск, 2003. – 119 с.
  19. Хоменко, С.А. Reading, Speaking, Writing. Методическое пособие для студентов старших курсов, магистрантов и аспирантов технических специальностей вузов / С.А. Хоменко, В.Ф. Скалабан, С.П. Личевская. – Минск, 2007. – 176 с.

20. Хоменко, С.А. Основы теории и практики перевода научно-технического текста с английского языка на русский. Учебное пособие / С.А. Хоменко, Е.Е. Цветкова, И.М. Басовец. – Минск, 2004. – 204 с.
21. Ялович, Е.И. Горные машины и оборудование. Разработка месторождений полезных ископаемых. Пособие по практическому курсу научно-технического перевода для студентов факультета природных ресурсов и экологии специальностей “Горные машины и оборудование”, “Разработка месторождений полезных ископаемых” / Е.И. Ялович, А.С. Милейко, А.М. Силицкая. – Минск, 2007. – 50 с.
22. Khomenko, S. English for Managers /S. Khomenko, V. Skalaban. – Минск: Вышэйшая школа, 2000. – 400 с.

### **Дополнительная**

1. Английский язык. Учебник для машиностроительных специальностей вузов / В.Н. Бгашев [и др.]. – М., 2003.
2. Антонов, О.И. Английский язык для бизнесмена / О.И. Антонов. – М., 1991.
3. Баранова, Н.П. Гибкие автоматизированные производства / Н.П. Баранова. – М., 1990.
4. Голикова, Ж.А. English Reader for Students of Polytechnic / Ж.А. Голикова, Л.В. Гусарова. – Минск, 1990.
5. Английский для делового общения / Г.Л. Дудкина [и др.]. - Часть I. – Мн., 1991.
6. Английский для делового общения / Г.Л. Дудкина [и др.]. Часть II. – Мн., 1991.
7. Микроэлектроника. Настоящее и будущее. Пособие по английскому языку для технических вузов / Л.П. Зайцева [и др.]. – М., 1990.
8. Иванов, А.О. Английские разговорные формулы / А.О. Иванов, Дж. Поуви. – М.: Просвещение, 1989.
9. Карневская, Е.Б. Учимся слушать и понимать английскую речь / Е.Б. Карневская, Н.А. Павлович. – Мн., 1995.
10. Курашвили, Е.И. Учебник для технических вузов (начальный курс) / Е.И. Курашвили. – М., 1991.
11. Полякова, Т.Ю. Английский язык для диалога с компьютером / Т.Ю. Полякова. – М., 1997.
12. Полякова, Т.Ю. Английский язык для инженеров / Т.Ю. Полякова, Е.В. Синявская. – М., 2000.
13. Сидоренко, Г.И. Малый бизнес: Пособие по чтению на английском языке для студентов экономических специальностей / Г.И. Сидоренко, В.А. Толстоухова. – Мн.: Бриллиант, 1998.
14. Хитрик, А.С. Speech Practice / А.С. Хитрик, А.С. Хоменко. – Минск, 2003. – 132 с.
15. Хитрик, А.С. Let Us Speak English / А.С.Хитрик, С.А. Хоменко, Э.И. Жорова. – Минск, БНТУ, 2005. – 112 с.

16. Хоменко, С.А. Сборник типовых тестов. Английский язык / С.А. Хоменко, В.Ф. Скалабан. – Минск: ТетраСистемс, 2005. – 112 с.
17. Христорождественская, Л.П. Intermediate English Course / Л.П. Христорождественская. – Часть 1. – Минск, 1997.
18. Христорождественская, Л.П. Практический курс английского языка / Л.П. Христорождественская. – Часть 2. – Минск, 1998.
19. Murphy, R. English Grammar in Use / R. Murphy. – Cambridge University Press, 1997.

### Видеокурсы:

Follow me to Britain

Introducing Great Britain

### Компьютерные средства обучения:

Интернет сайты: [www.wikipedia.org](http://www.wikipedia.org)  
[www.britannica.org](http://www.britannica.org)  
[www.englishclub.net](http://www.englishclub.net)  
[www.english-to-go.com](http://www.english-to-go.com)  
[www.globalenvision.org](http://www.globalenvision.org)

## 4.4 Критерии оценки результатов учебной деятельности

### Чтение и письменный перевод

Баллы	Критерии оценки
10 (десять)	Беглое чтение с соблюдением интонационных моделей. Правильный перевод всего текста с соблюдением лексических и грамматических норм перевода на родной язык.
9 (девять)	Недостаточная беглость: незначительные ошибки в произношении. Правильный перевод всего текста с соблюдением лексических и грамматических норм перевода. Допускаются единичные несущественные грамматические ошибки.
8 (восемь)	Недостаточная беглость: ошибки в разделении текста на смысловые группы. При переводе всего текста допускается одна грамматическая ошибка и неточность в переводе лексических единиц.
7 (семь)	Отдельные ошибки в правилах чтения, в интонации и произношении. При переводе 75% текста допускается две грамматические ошибки и неточность в переводе отдельных лексических единиц.
6 (шесть)	Отдельные ошибки в правилах чтения, в интонации и произношении. Допускаются три грамматические и единичные лексические ошибки при переводе 75% текста.
5 (пять)	Грубые ошибки в произношении, в правилах чтения. Допускаются четыре грамматические ошибки при переводе 50% текста. Затруднения в выборе правильного перевода лексических единиц.
4 (четыре)	Отсутствие правильного смыслового и интонационного оформления текста. Допущено более четырех грамматических ошибок при переводе 50% текста. Ошибки в переводе лексических единиц. Отдельные смысловые ошибки при переводе.
3	Отсутствие правильного смыслового и интонационного оформления текста.

(три)	Неадекватный перевод грамматических и лексических структур. Грубые смысловые ошибки при переводе 50% текста.
2 (два)	Отсутствие правильного смыслового и интонационного оформления текста. Неадекватный перевод грамматических и лексических структур. Грубые смысловые ошибки при переводе 40% текста.
1 (один)	Отсутствие правильного смыслового и интонационного оформления текста. Отсутствие навыков чтения. Неадекватный перевод грамматических и лексических структур.

### Говорение. Ситуативно-тематическая беседа

Баллы	Критерии оценки
10 (десять)	Адекватная и полная реализация коммуникативной задачи. Связность, полнота, спонтанность, лексическое и грамматическое разнообразие с использованием идиом, выражений оценочного характера, средств речевого этикета, выражения собственного мнения при отсутствии ошибок.
9 (девять)	Реализация коммуникативной задачи. Связность, полнота, лексическое и грамматическое разнообразие и использование оценочных фраз, средств речевого этикета при отсутствии ошибок.
8 (восемь)	Реализация коммуникативного намерения в ситуациях, предусмотренных учебной программой. Связность, полнота, лексическое и грамматическое разнообразие, использование средств речевого этикета. Наличие единичных несущественных ошибок.
7 (семь)	Реализация коммуникативного намерения в ситуациях, предусмотренных учебной программой. Некоторые нарушения композиционной структуры высказывания. Ограниченность в разнообразии лексических и грамматических структур. Нарушение норм произношения, затрудняющих понимание в отдельных случаях. Наличие единичных ошибок.
6 (шесть)	Недостаточно полная реализация коммуникативного намерения. Ограниченный объем высказывания. Недостаточная беглость речи с оговорками и немногочисленными ошибками в употреблении словаря и грамматических структур.
5 (пять)	Реализация коммуникативного намерения осложнена значительными затруднениями в выборе языковых средств и формулировании содержания речи. Наличие некоторых лексических и грамматических ошибок.
4 (четыре)	Неполная реализация коммуникативного намерения. Ограниченный объем высказывания. Много ошибок в употреблении словаря и грамматических структур. Значительные нарушения произносительных норм, затрудняющих понимание речи.
3 (три)	Ограниченный словарный запас и недостаточное владение грамматическими структурами затрудняют реализацию коммуникативного намерения. Объем высказывания ограничен. Наличие лексических, грамматических и фонетических ошибок сильно затрудняют понимание речи.
2 (два)	Ограниченный словарный запас и недостаточное владение грамматическими структурами затрудняют реализацию коммуникативного намерения. Значительные нарушения произносительных норм, затрудняющих понимание речи. Наличие грубых лексических, грамматических и фонетических ошибок мешают пониманию речи.
1 (один)	Отсутствие реализации коммуникативного намерения

## Лексико-грамматический тест

Баллы	Критерии оценки
10 (десять)	при 100% правильных ответов
9 (девять)	при 95%-99% правильных ответов
8 (восемь)	при 81%-94% правильных ответов
7 (семь)	при 71%-80% правильных ответов
6 (шесть)	при 61%-70% правильных ответов
5 (пять)	при 51%-60% правильных ответов
4 (четыре)	при 41%-50% правильных ответов
3 (три)	при 31%-40% правильных ответов
2 (два)	при 21% и ниже
1 (один)	При 11% и ниже

# **Белорусский национальный технический университет**

**УТВЕРЖДАЮ**

Проректор по учебной,  
воспитательной, аналитической и  
информационной работе

\_\_\_\_\_ Г.Ф. Ловшенко

\_\_\_\_\_

Регистрационный № УД-\_\_\_\_\_

## **СПЕЦКУРС ИНОСТРАННОГО ЯЗЫКА (АНГЛИЙСКИЙ ЯЗЫК)**

**Учебная программа для специальности**

1-44 01 01 **Организация перевозок и управление на автомобильном и  
городском транспорте**

Минск 2013г.



**СОСТАВИТЕЛЬ(И):**

А.О. Боярская, доцент кафедры «Английский язык № 1» Белорусского национального технического университета, кандидат филологических наук, доцент.

**РЕЦЕНЗЕНТЫ:**

**О.В. Веремейчик**, зав. кафедрой иностранных языков Белорусского национального технического университета, кандидат педагогических наук;

**Т.Г. Лукша**, зав. кафедрой английского языка естественных факультетов БГУ, кандидат филологических наук, доцент.

**РЕКОМЕНДОВАНА К УТВЕРЖДЕНИЮ:**

Кафедрой «Английский язык № 1» Белорусского национального технического университета  
(протокол № \_\_\_\_\_ от \_\_\_\_\_ 2013г.)

Заведующая кафедрой \_\_\_\_\_

подпись

С.А. Хоменко

Методической комиссией автотракторного факультета Белорусского национального технического университета  
(протокол № \_\_\_\_\_ от \_\_\_\_\_ 2013г.)

Председатель методической  
комиссии \_\_\_\_\_

С.А. Сидоров

Ответственный за редакцию \_\_\_\_\_ А.О.Боярская  
Ответственный за выпуск \_\_\_\_\_

## ПОЯСНИТЕЛЬНАЯ ЗАПИСКА

Учебная программа разработана для специальности 1-44 01 01 «Организация перевозок и управление на автомобильном и городском транспорте» для специализации 1-44 01 03 «Международные автомобильные перевозки».

**Цель** данного курса – формирование иноязычной коммуникативной компетенции будущего специалиста в области международных автомобильных перевозок, позволяющей использовать иностранный язык как средство профессионального и межличностного общения.

**Задачами** обучения иностранному языку на данном этапе являются:

- совершенствование коммуникативных навыков профессионального общения;
- совершенствование навыков письменного и устного перевода по специальности с английского языка на русский и с русского на английский;
- совершенствование навыков чтения специальной литературы для использования их в профессиональной и в научно-исследовательской работе.

В результате освоения дисциплины «Спецкурс иностранного языка» студент должен

**знать:**

- иностранный язык (английский) на уровне, достаточном для решения профессиональных задач;
- особенности системы изучаемого иностранного языка в его фонетическом, лексическом и грамматическом аспектах;
- социокультурные нормы бытового и профессионального общения, а также правила речевого этикета, позволяющие специалисту эффективно использовать иностранный язык как средство общения;

**уметь:**

- использовать знание иностранного языка в профессиональной деятельности, профессиональной коммуникации и межличностном общении;
- вести общение социокультурной и профессиональной направленности в объеме, предусмотренном настоящей программой;
- читать и переводить литературу по специальности (изучающее, ознакомительное, просмотровое, поисковое чтение);
- письменно выражать свои коммуникативные намерения в сферах, предусмотренных настоящей программой;

**приобрести навыки:**

- работы с профессиональной литературой с целью извлечения и переработки информации;
- презентации информации на английском языке по профессиональной тематике;
- деловой коммуникации в профессиональной сфере.

## **Методы (технологии) обучения**

Учебный процесс базируется на модели смешанного обучения, которая помогает эффективно сочетать традиционные формы обучения и новые технологии. При обучении иностранному языку используются следующие образовательные технологии:

- традиционные технологии: чтение, перевод и анализ текста, реферативный пересказ;
- технология коммуникативного обучения, направленная на формирование коммуникативной компетентности студентов, которая является базовой, необходимой для адаптации к современным условиям межкультурной коммуникации;
- технология индивидуализации обучения, помогающая реализовывать личностно-ориентированный подход, учитывая индивидуальные особенности студентов;
- информационно-коммуникационные технологии, расширяющие рамки образовательного процесса и повышающие познавательную активность, предполагающие использование компьютерных программ и Интернет-технологий для поиска информации, работы с электронными словарями и справочниками;
- проектная технология, которая способствует реализации междисциплинарного характера компетенций, формирующихся в процессе обучения английскому языку.

## **Организация самостоятельной работы студентов**

При изучении данного спецкурса рекомендуется использовать следующие формы самостоятельной работы:

- контролируемая самостоятельная работа в виде выполнения индивидуальных заданий преподавателя (выполнить упражнения, выписать ключевые слова, составить диалог, написать реферативный перевод и др. в соответствии с календарным планом);
- управляемая самостоятельная работа в виде подготовки глоссария профессиональных терминов, эссе по прочитанной литературе, презентаций и проектов;
- подготовка рефератов по пройденным темам с использованием ресурсов Интернета, подготовка выступлений на научную студенческую конференцию.

## **Диагностика компетенций студента**

Для оценки достижений студента используется:

- устный и письменный опрос во время практических занятий;
- промежуточный и итоговый тестовый контроль;
- презентации по пройденному материалу;
- зачет по дисциплине в конце каждого семестра.

Согласно учебному плану на изучение спецкурса отведено всего 330 часов, в том числе 172 часа аудиторных занятий (практические занятия).

### Примерный тематический план

Наименование раздела и темы	Практические занятия (часы)
<b>Раздел I. Профессионально-ориентированное общение</b>	
Тема 1.1. Разговор по телефону	10
Тема 1.2. Погрузка и оформление груза	15
Тема 1.3. Таможня	10
Тема 1.4. Ориентировка на дороге	15
<b>Раздел II. Проблемы международных перевозок</b>	
Тема 2.1. Автомобильные перевозки	10
Тема 2.2. Проблемы на дорогах	10
Тема 2.3. Транспорт и окружающая среда	10
Тема 2.4. Логистика	8
Тема 2.5. Международные организации автомобильных перевозок	12
Тема 2.6. TIR	8
Тема 2.7. Контейнеризация	6
Тема 2.8. Информационные технологии на транспорте	6
<b>Раздел III. Деловая транспортная документация</b>	
Тема 3.1. Контракты и соглашения	14
Тема 3.2. Деловая корреспонденция	20
Тема 3.3. Логистические специальности	8
Тема 3.4. Документы для приема на работу	8
ВСЕГО	172

## СОДЕРЖАНИЕ ДИСЦИПЛИНЫ

### Раздел I. Профессионально - ориентированное общение

#### Тема 1.1. Разговор по телефону

Проблемы коммуникации. Телефонный этикет. Чтение цифр, дат и символов. Обсуждение транспортных проблем по телефону.

#### Тема 1.2. Погрузка и оформление груза

Единицы измерений и аббревиатуры. Типы грузовиков и грузов. Заполнение формы коммерческого предложения. Маркировка и упаковка. Отгрузка и перевозка.

#### Тема 1.3. Таможня

В таможне. Таможенные документы для перевозки грузов.

#### Тема 1.4. Ориентировка на дороге

Как проехать по городу, к заправке. Как спросить направление.

## **Раздел II. Проблемы международных перевозок**

### **Тема 2.1. Автомобильные перевозки**

История дорожного движения. Транспортные перевозки в Европейском Союзе. Мультимодальный транспорт.

### **Тема 2.2. Проблемы на дорогах**

Технология борьбы с заторами в Лондоне и Великобритании. Транспорт в часы пик. Дорожная терминология.

### **Тема 2.3. Транспорт и окружающая среда**

Транспорт в городах. Проблемы транспорта и экологии.

### **Тема 2.4 Логистика**

Логистика как наука. Логистический менеджмент и цепь поставок.

### **Тема 2.5. Международные организации автомобильных перевозок**

FIATA – структура, цели и документы. IRU.

### **Тема 2.6. TIR**

История создания и основные принципы. TIR Carnet.

### **Тема 2.7. Контейнеризация**

Преимущество контейнеризации. Типы контейнеров.

### **Тема 2.8 Информационные технологии на транспорте**

IT - технологии в перевозках. Инновации на транспорте.

## **Раздел III. Деловая транспортная документация**

### **Тема 3.1. Контракты и соглашения**

Контракты и соглашения. Incoterms. Interbus Agreement. Лексика транспортных документов.

### **Тема 3.2. Деловая корреспонденция**

Деловые и коммерческие письма. Запросы, претензии, предложения.

### **Тема 3.3. Логистические специальности**

Логистические специальности в перевозках: экспедитор, логист, таможенный агент, складской менеджер, диспетчер.

### **Тема 3.4. Документы для приема на работу**

Письмо-заявка на работу. Резюме. Сопроводительное письмо. Характеристика.

## ИНФОРМАЦИОННО-МЕТОДИЧЕСКАЯ ЧАСТЬ

### Основная литература

1. Боярская, А.О. English for Transportation. Пособие по английскому языку для специалистов по организации перевозок / А.О. Боярская, Л.В. Педько, Е.В. Слесаренок. – Минск: БНТУ, 2009. – 111 с.
2. Боярская, А.О. Transport Business Documentation: пособие / А.О. Боярская, Л.В. Педько, Е.В. Слесаренок. – Минск: БНТУ, 2011. – 110 с.
3. Боярская, А.О. Spoken English for Transportation: пособие / А.О.Боярская, Н.Ф. Ладутько, Т.Е.Митьковец .– Минск: БНТУ, 2012. – 78 с.

### Дополнительная литература

1. Гниненко, А.В. Англо-русский учебный иллюстрированный словарь: автомобильные и машиностроительные специальности. / А.В. Гвиненко – Москва: Астрель; ФСТ: Транзиткнига, 2005. – 283 с.
2. Пивовар, А.Г. Англо-русский словарь по внешней торговле и международным транспортным операциям / А.Г. Пивовар. – Москва: Астрель. АСТ, 2003 – 476 с.
3. Тверитнев, М.В. Англо-русский и русско-английский автомобильный словарь. – М.: Russo, 1999.
4. Хоменко, С.А. Основы теории и практики перевода научно – технического текста с английского языка на русский: учебное пособие. / С.А. Хоменко, Е.Е. Цветкова, И.М. Басовец, – Минск: БНТУ, 2004. – 203с.
5. Kavanagh, Marie. English for the Automobile Industry / Marie Kavanagh. – Express Series: Oxford University Press, 2007. – 80 pages.
6. Pilbeam, A. Market Leader. Logistics Management. Business English / A.Pilbeam, N.O’Driscoll. – Longmann, 2010. – 98 pages.
7. Trade Facilitation Terms: An English - Russian Glossary. Упрощение процедур торговли: англо-русский глоссарий терминов. – 2-е изд. – Нью-Йорк, Женева, 2011. – 3 10 с.

### КРИТЕРИИ ОЦЕНКИ РЕЗУЛЬТАТОВ УЧЕБНОЙ ДЕЯТЕЛЬНОСТИ

	Критерии оценки
<b>Не зачтено</b>	Недостаточно полный объем знаний в рамках дисциплины; знание части основной литературы, рекомендованной учебной программой дисциплины; использование научной терминологии, изложение ответа на вопросы с существенными ошибками; слабое владение инструментарием учебной дисциплины, неумение ориентироваться в основных направлениях дисциплины; пассивность на практических занятиях; низкий уровень культуры исполнения заданий

<b>Зачтено</b>	Достаточные знания в объеме учебной программы; использование научной терминологии, грамотное, логически правильное изложение ответа на вопросы, умение делать выводы; владение инструментарием учебной дисциплины, умение его использовать; способность самостоятельно применять типовые решения в рамках учебной программы; усвоение основной литературы, рекомендованной учебной программой дисциплины; умение ориентироваться в теориях, методах и направлениях дисциплины ; самостоятельная работа на практических занятиях, фрагментарное участие в групповых обсуждениях, достаточный уровень культуры исполнения заданий
----------------	---