

Measurement Stand, Method and Results of Composite Electrotechnical Pressboard-Mineral Oil Electrical Measurements

P. Rogalski

Lublin University of Technology,
Nadbystrzycka str., 38A, Lublin 20-618, Poland

Received 21.07.2020

Accepted for publication 03.09.2020

Abstract

The paper presents a measuring stand designed and built for testing direct and alternating current properties of power transformers basic insulation component i.e. electrotechnical pressboard impregnated with transformer oil. Measurements of direct and alternating current parameters are performed using the frequency domain spectroscopy and polarization depolarization current methods.

The measuring station includes a specially developed climatic chamber which is characterized by high accuracy of temperature stabilization and maintenance during several dozen hours of measurements. The uncertainty of temperature maintaining during several dozen hours of measurements does not exceed ± 0.01 °C. The computer software developed to control the station allows for remote measurements, changes in supply voltage and temperature settings and acquisition of the obtained results. A new type of measuring capacitor was developed and manufactured, the structure of which significantly reduces the chance of samples contamination during measurements. By increasing the accuracy of temperature stabilization during measurements, the resolution of measurement temperatures was increased, at which it is possible to perform measurements with the frequency domain spectroscopy and polarization depolarization current methods. This allowed to reduce the step of measurement temperature change and thus to increase the accuracy of determining the activation energy of the measured parameters.

The article also contains basic information on the analysis of the direct and alternating current electrical parameters of the composite electrotechnical pressboard-mineral oil-water nanoparticles. The results of several direct and alternating current parameters measurements of a transformer oil impregnated pressboard sample with a moisture content of (5.2 ± 0.1) % by weight obtained by the use of a measuring stand are presented as examples.

Keywords: AC and DC measurements by FDS and PDC methods, electrotechnical pressboard, insulating oil.

DOI: 10.21122/2220-9506-2020-11-3-187-195

Адрес для переписки:

P. Rogalski
Lublin University of Technology,
Nadbystrzycka str., 38A, Lublin 20-618, Poland
e-mail: p.rogalski@pollub.pl

Address for correspondence:

P. Rogalski
Lublin University of Technology,
Nadbystrzycka str., 38A, Lublin 20-618, Poland
e-mail: p.rogalski@pollub.pl

Для цитирования:

P. Rogalski.
Measurement Stand, Method and Results of Composite Electrotechnical Pressboard-Mineral Oil Electrical Measurements.
Приборы и методы измерений.
2020. – Т. 11, № 3. – С. 187–195.
DOI: 10.21122/2220-9506-2020-11-3-187-195

For citation:

P. Rogalski.
Measurement Stand, Method and Results of Composite Electrotechnical Pressboard-Mineral Oil Electrical Measurements.
Devices and Methods of Measurements.
2020, vol. 11, no. 3, pp. 187–195.
DOI: 10.21122/2220-9506-2020-11-3-187-195

Установка, методика и результаты измерений электрических параметров композита электротехнический картон-трансформаторное масло

П. Рогальски

Люблинский технический университет,
ул. Надбыстрицкая, 38А, Люблин 20-618, Польша

Поступила 21.07.2020

Принята к печати 03.09.2020

В работе представлена разработанная и изготовленная установка для исследования одной из главных составляющих изоляции энергетических трансформаторов – электротехнического картона, пропитанного трансформаторным маслом.

В состав установки входит специально разработанная климатическая камера с высокой точностью измерения, стабилизации и поддержания в течение длительного времени температуры. Точность поддержания и измерения температуры в течение нескольких десятков часов измерений не превосходит $\pm 0,01$ °С. Электрические измерения на постоянном токе выполнены с использованием метода токов поляризации и депольаризации (англ. *Polarization Depolarization Current*, сокр. *PDC*), а на переменном токе – методом импедансной спектроскопии (англ. *Frequency Domain Spectroscopy*, сокр. *FDS*). Управление работой установки и процессом измерений осуществляется с помощью разработанной компьютерной программы, которая позволяет дистанционно проводить измерения, изменять вид измерений, величины напряжения и температуры, а также регистрировать результаты измерений.

Разработан и изготовлен измерительный конденсатор нового типа, конструкция которого значительно уменьшает вероятность загрязнения образцов в процессе измерений. Благодаря увеличению точности стабилизации и поддержания температуры во время измерений уменьшен шаг изменения температуры при измерениях методами *FDS* и *PDC*. Это позволило увеличить точность определения энергии активации измеряемых параметров.

Представлена также основная информация по анализу результатов измерений на постоянном и переменном токе композита – электротехнический картон, пропитанный трансформаторным маслом, содержащим нанокapли воды. В качестве примера представлены результаты нескольких измерений основных параметров электротехнического картона, пропитанного трансформаторным маслом, содержащим нанокapли воды в концентрации $(5,2 \pm 0,1)$ % вес., полученные на установке.

Ключевые слова: измерения на постоянном и переменном токе методами *FDS* и *PDC*, электротехнический картон, трансформаторное масло.

DOI: 10.21122/2220-9506-2020-11-3-187-195

Адрес для переписки:

P. Rogalski
Lublin University of Technology,
Nadbystrzycka str., 38A, Lublin 20-618, Poland
e-mail: p.rogalski@pollub.pl

Address for correspondence:

P. Rogalski
Lublin University of Technology,
Nadbystrzycka str., 38A, Lublin 20-618, Poland
e-mail: p.rogalski@pollub.pl

Для цитирования:

P. Rogalski.
Measurement Stand, Method and Results of Composite Electrotechnical Pressboard-Mineral Oil Electrical Measurements.

Приборы и методы измерений.

2020. – Т. 11, № 3. – С. 187–195.

DOI: 10.21122/2220-9506-2020-11-3-187-195

For citation:

P. Rogalski.
Measurement Stand, Method and Results of Composite Electrotechnical Pressboard-Mineral Oil Electrical Measurements.

Devices and Methods of Measurements.

2020, vol. 11, no. 3, pp. 187–195.

DOI: 10.21122/2220-9506-2020-11-3-187-195

Introduction

For over a century cellulose in form of paper and pressboard impregnated with mineral oil is a mainly used material for power transformers insulation. It is related to good electrical parameters and cost efficiency of cellulose-mineral oil composite. This kind of insulation is usually called paper-oil or liquid-solid insulation. The main source of this type of insulation malfunction is increase of cellulose water content. At the beginning of transformer operation water level of cellulose is usually lower than 0.8 %. With years of the device operation water penetrates seals of transformer, solutes in oil and then is transported by it to the solid component of insulation. After exceeding 5 % of water content in pressboard or paper the catastrophic breakdown of transformer is only a matter of time. Recently it was discovered that water in cellulose insulation occurs in form of nanodrops [1] creating cellulose-mineral oil-water nanodrops composite.

Due to the fact that transformers are hermetic devices extraction of insulation sample is impossible. Because of that reason nowadays a lot of effort is made to develop non-destructive methods of paper and pressboard moisture level determination [2]. The most popular are electrical methods. They can be classified into two basic group. The first one includes methods based on measurements in the time domain like the return voltage measurement (RVM) [3, 4] and polarization-depolarization current (PDC) measurement [5], [6] while in the second one there are methods based on measurements using frequency-domain spectroscopy (FDS) [7, 8].

Presented in this article measurement stand enables usage of FDS and PDC method. Due to the low accuracy of temperature stabilization, so far in research of temperature impact on solid-liquid electrical parameters it was necessary to use results for a large temperature differences, for example $\Delta T = 30\text{ }^{\circ}\text{C}$ [9]. By increase of thermal stabilization accuracy during the FDS and PDC measurements of composite cellulose-mineral oil-water nanodrops, it became possible to increase the concentration of the measurements performed in a function of temperature to $\Delta T = 8\text{ }^{\circ}\text{C}$. Usually FDS measurements are made in frequency range from 100 μHz to 5 kHz, with 3 points per decade resolution. A further rise in accuracy was obtained by increasing the number of measurement points per decade to 10 for the frequency range from 1 MHz to 5 kHz and 5 for the frequency range from 100 μHz to 1 MHz.

The aim of this study was to develop a new measurement stand for precise tests of direct and alternating current parameters of the composite electrotechnical pressboard-transformer oil-water nanodrops in a wide range of measurement temperatures, the maintenance accuracy of which is below $\pm 0.01\text{ }^{\circ}\text{C}$. And to present selected measurement results for a sample with a moisture content of 5.2 % by wt.

The new polarization depolarization current and frequency domain spectroscopy measurement stand

Figure 1 shows a diagram with basic elements of the measuring stand. The stand includes: climatic chamber, measuring capacitor with a sample in glass vessel, Omicron Dirana FDS Analyzer, Agilent data acquisition unit with a PT100 temperature sensor, a computer with control and recording software.

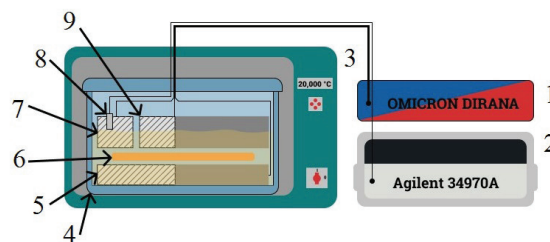

Figure 1 – Diagram of the stand for the measurements of direct and alternating current electrical properties of liquid-solid insulation: 1 – Dielectric Response Analyzer Omicron Dirana; 2 – Agilent 34970a data acquisition unit; 3 – climatic chamber; 4 – glass vessel; 5 – measuring electrode; 6 – sample of oil-impregnated pressboard; 7 – guard electrode; 8 – PT100 temperature sensor; 9 – voltage electrode

The measurement of dielectric response analysis is made by Omicron Dirana FDS meter. The device is equipped with voltage source with maximum output voltage amplitude of 200 V and maximum output current of 50 mA. The voltage source is capable of outputting direct voltage and alternating voltage in frequency range 10 μHz –5 kHz. The meter can measure dissipation factor value up to 100, with accuracy $1\% \pm 3 \cdot 10^{-4}$ and capacitance in range from 10 pF to 100 μF , with accuracy of $0.5\% \pm 1\text{ pF}$. Furthermore, the device is capable of direct current measurement in range of $\pm 10\text{ mA}$, with accuracy of $0.5\% \pm 1\text{ pA}$, which is used in PDC measurements. The meter work is fully supervised by computer software. The Dirana FDS meter is

capable of performing in field measurements on number of devices such as: power transformers, autotransformers, bushings, cables, current and voltage transformers and electric motors, by using predefined setups. Due to high electromagnetic interference in case of infield measurements, the meter is equipped in advance noise suppression functions. Which facilitates measurements both in the laboratory and in the field conditions.

For the need of the measuring station, a three-electrode measuring capacitor was designed and manufactured. It was built only of aluminum, and as an insulator in between guarded and unguarded electrode air gap was used. Before measurement, capacitor is placed in glass cylindrical vessel, which dimensions are few millimeters bigger than capacitor itself. Small volume of oil in the vessel reduces chances of moisture migration between oil and pressboard during measurements performed in different temperatures, due to changes of water solubility in oil. After putting a sample of oil impregnated pressboard into the capacitor, air gap is filled with oil in which the sample was stored. All electrical connections are made of silver plated copper wire without any insulation. This approach is to eliminate potential measured sample contamination. At the end the vessel with the capacitor is hermetically closed.

Temperature value is measured by Agilent 34970a data acquisition unit with use of PT100 sensor in time intervals of 1 s.

The specificity of the measurements requires high accuracy of temperature stabilization during the measurement. In order to obtain this objective, it was decided to build a climate chamber. For this purpose, it was decided to modernize an old stove that was once used for material testing. The housing and heating elements have remained from the old device. The electronic control system was redesigned and made. The new control system includes: the LCD display that allows to monitor the current parameters of the chamber, the keyboard for entering settings, the solid state relay (SRT) as an executive element, the 12 V DC stabilized power supply and the main controller board. Electronic circuit, printed circuit board and software of controller was made. The heart of the controller is the ATMEGA368 microcontroller. The temperature is measured using the four-wire method with use of a PT1000 sensor. The MCP3550-50 Single-Channel 22-Bit Delta-Sigma ADC chip is responsible for the conversion of the analog voltage signal representing temperature to digital form, and then sending its value to the

microcontroller via SPI bus 11 times per minute. Based on the obtained temperature value and using PID algorithm, the microcontroller controls SRT to regulate the power of the heater inside the chamber. For precise control of the heater's power, phase control was used. To make its realization possible, the controller board is equipped with a mains voltage zero crossing detection circuit. Inside the chamber five small fans were used for fast and even heat distribution. In order to achieve temperatures lower than the ambient temperature, it was necessary to use a cold air source. For this purpose, a small freezer was used, which was connected to the climate chamber with two thermally insulated pipes. One of them is equipped with a fan forcing cold air to flow into the chamber. The rotational speed of the fan is supervised by the main controller. The operation of the freezer is steered by a relay located on the controller board. The device is equipped with three independent thermal fuses. One software and two physical in two different circuits. The overheating protections will react selectively after exceeding the temperature of 100 °C. This threshold level was selected due to the flammability of measured mineral oils. The climatic chamber can be controlled via the USB bus by a computer. For this purpose, a Windows Forms Application software was developed, which enables the display of the current temperature and settings. It also provides the settings entering. In addition, the software allows to program any two actions with a given date and time, for example, in order to switch off or change the chamber settings. Measurements of capacitor temperature in time of FDS and PDC measurements are shown in Figure 2.

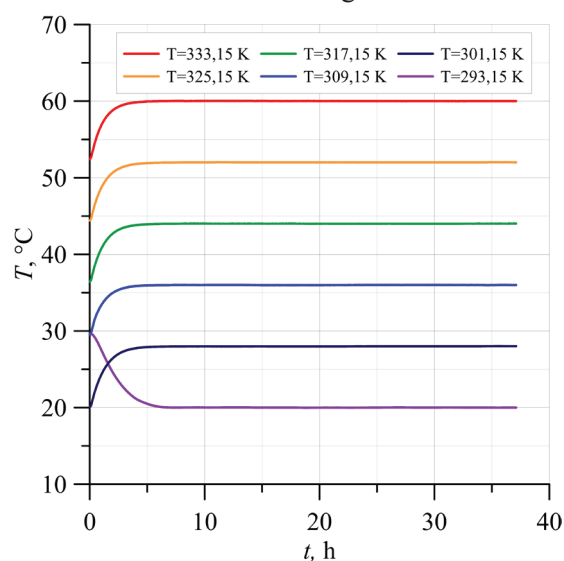

Figure 2 – Time dependence of the measuring capacitor temperature

In order to estimate uncertainty of a temperature stabilization, standard deviation of measured temperatures was calculated (Figure 3). As can be seen in Figure 3, all values of standard deviation are lower than ± 0.01 °C. Higher values of standard deviation for temperature 20 °C and 28 °C than for the rest of temperatures, are caused by on-off cycle of cooling device operation, which is used in this measurements.

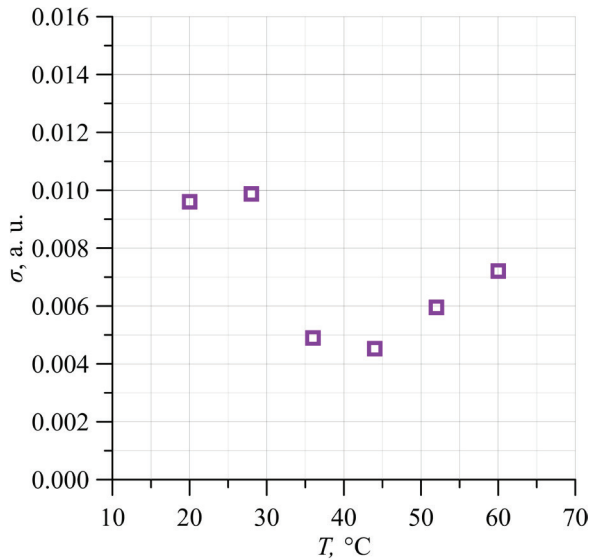

Figure 3 – Measurement uncertainty of temperature stabilization

Fundamentals of the direct and alternating current material parameters analysis of the composite cellulose-transformer oil-water nanoparticles

Direct current conductivity measurements of the composite cellulose-transformer oil-water nanoparticles take place in a three-electrode system [5], in which two electrodes, measuring and voltage, are used to determine the conductivity. The third electrode is designed to conduct the surface current to the ground, characteristic in high-resistance systems. Due to high values of relaxation times in the tested materials, measurements within several hours are necessary to achieve the value of the set current. After obtaining the value of the set current I , the direct current conductivity is determined by the formula:

$$\sigma_{DC} = \frac{I \cdot d}{U \cdot S}, \quad (1)$$

where: I – steady value of current; U – applied voltage; d – pressboard thickness; S – electrode area.

Measurements of the alternating current insulation characteristics of power transformers are performed with FDS meters in a parallel equivalent circuit, shown in the Figure 4a. The phasor diagram for the parallel equivalent circuit is shown in Figure 4b.

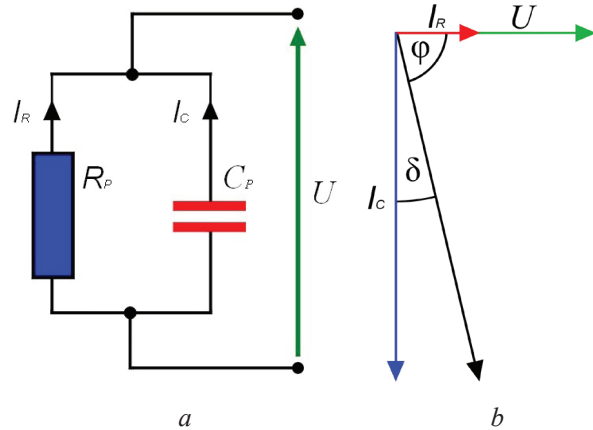

Figure 4 – Parallel equivalent diagram of the insulating material (a): U – supply voltage amplitude; I_R – conduction current amplitude; I_C – displacement current amplitude; R_p – resistance; C_p – capacitance and phasor diagram for the parallel equivalent diagram (b): φ – phase shift angle; δ – loss angle

The second Maxwell equation (generalized Ampere's law) shows that in real dielectric materials a conduction current flows with a density \mathbf{j}_R and a displacement current with a density \mathbf{j}_C , so that [7]:

$$\Delta \times \mathbf{H} = \mathbf{j}_R + \mathbf{j}_C, \quad (2)$$

where: \mathbf{H} – vector of the magnetic field strength; \mathbf{j}_R – conduction current density; \mathbf{j}_C – displacement current density.

In FDS measurements, a sinusoidal forcing electric field with a circular frequency ω is used:

$$\mathbf{E} = \mathbf{E}_0 \sin(\omega t), \quad (3)$$

where: \mathbf{E} – electric field strength; \mathbf{E}_0 – electric field amplitude; ω – circular frequency; t – time.

The conduction current density, falling into the second Maxwell equation, is described by the formula:

$$\mathbf{j}_R(\omega) = \sigma(\omega) \mathbf{E} = \sigma(\omega) \mathbf{E}_0 \sin(\omega t), \quad (4)$$

where $\sigma(\omega)$ – conductivity.

Displacement current density, falling into the second Maxwell equation:

$$j_c(\omega) = \frac{\partial \mathbf{D}}{\partial t} = (\mathbf{D} = \varepsilon_0 \varepsilon' \mathbf{E}) = \omega \varepsilon' \varepsilon_0 \mathbf{E}_0 \sin(\omega t - \frac{\pi}{2}), \quad (5)$$

where: ε' – relative dielectric permittivity; ε_0 – dielectric permittivity of vacuum; \mathbf{D} – electric field induction vector.

The conductivity in equation (4) describes the material's ability to conduct an electric current. The dielectric permittivity ε' in the formula (5) describes the ability of the dielectric to polarize. In impregnated pressboard occurs dependencies of conductivity and permeability on temperature, frequency and moisture. In real dielectrics, the phase shift angle φ ranges from 0° to -90° (Figure 4). Meters designed to measure alternating current parameters of electrical systems, the so-called impedance (admittance) meters measure two basic values characteristic for systems containing passive elements. In the parallel equivalent scheme, these are the values of the phase shift angle φ and the admittance Y :

$$Y = \frac{i}{V}, \quad (6)$$

where: Y – admittance; V – voltage amplitude; i – current amplitude.

Parameters such as conductance G_p and capacitance C_p in a parallel equivalent circuit and the tangent of the loss angle $\tan \delta$ are most often used to analyze the results of in power transformers insulation measurements. The FDS meter calculates these parameters using formulas:

$$G_p = |Y \cos \varphi|; \quad (7)$$

$$C_p = \frac{|Y \sin \varphi|}{\omega}; \quad (8)$$

$$\tan \delta = \frac{1}{|\tan \varphi|} = |\cotan \varphi|. \quad (9)$$

Based on the G_p and C_p values, taking into account the geometrical dimensions of the dielectric material, such as the thickness of the pressboard d and the surface area of the measuring electrode S , the material parameters are calculated using appropriate formulas – conductivity and relative dielectric permittivity, which are included in the second Maxwell equation:

$$\sigma = \frac{G_p d}{S} = \frac{|Y \cos \varphi| d}{S}, \quad (10)$$

where: σ – conductivity; G_p – conductance; d – dielectric thickness; S – voltage electrode surface area.

$$\varepsilon' = \frac{C_p d}{\omega \varepsilon_0 S} = \frac{|Y \sin \varphi| d}{\omega \varepsilon_0 S}, \quad (11)$$

where: C_p – capacitance; ε_0 – dielectric permittivity of vacuum; d – dielectric thickness; S – voltage electrode surface area.

$$\varepsilon'' = \frac{\sigma}{\omega \varepsilon_0} = \frac{|Y \cos \varphi| d}{\omega \varepsilon_0 S}. \quad (12)$$

For the analysis of relaxation processes, the power loss value ε'' , calculated as:

The power loss value is used to develop its dependence on the permeability value, so-called Cole-Cole plots $\varepsilon''(\varepsilon')$. The shape of the Cole-Cole charts is related to the mechanisms of relaxation [10].

The analysis of formulas (4)–(12) shows that the admittance and phase shift angle are the basic measurement parameters determined in the FDS method. On the basis of these values, using the formulas (7)–(12), it is possible to calculate the electrical parameters of cellulose-mineral oil-water nanoparticles composite.

Measurements results of the cellulose-mineral oil-water nanoparticles composite

In the work electrotechnical pressboard and transformer oil with a moisture content of several ppm produced by the world's leading companies, dedicated to the construction for power transformers insulation, were used. A pressboard sample with a moisture content of 5.2 ± 0.1 % by weight was prepared for the tests. The work includes measurements of basic direct and alternating current parameters:

- time dependence of the polarization and depolarization currents and their difference, determining the strength of the resistive current (Figure 5);

- frequency dependence of admittance Y (Figure 6);

- frequency dependence of the phase shift angle φ (Figure 7).

Based on measurements of admittance and phase angle, using the formulas (10)–(12) frequency dependencies of the loss angle tangent $\tan \delta$ (Figure 8), alternating current conductivity σ (Figure 9), permittivity ε' (Figure 10) and power loss value ε'' (Figure 11), were calculated.

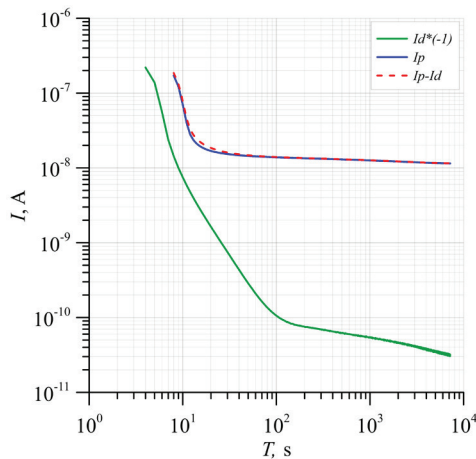

Figure 5 – Time relationships of the polarization current I_p , depolarization current $-I_d$ and their difference $-I_p - I_d$ of the electrotechnical pressboard impregnated with transformer oil with a moisture content of 5.2 % by weight measured at 293.15 K

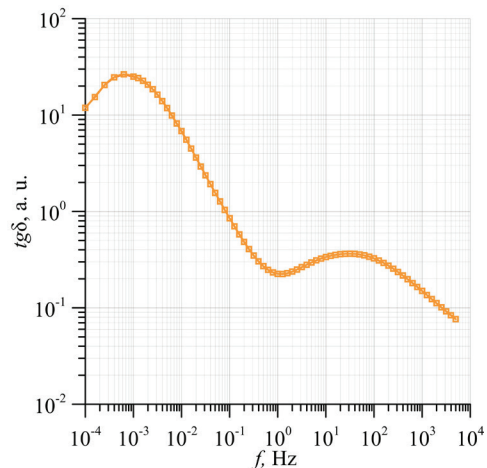

Figure 8 – Frequency dependence of the loss angle tangent of electrotechnical pressboard impregnated with transformer oil with a moisture content of 5.2 % by weight measured at 325.15 K

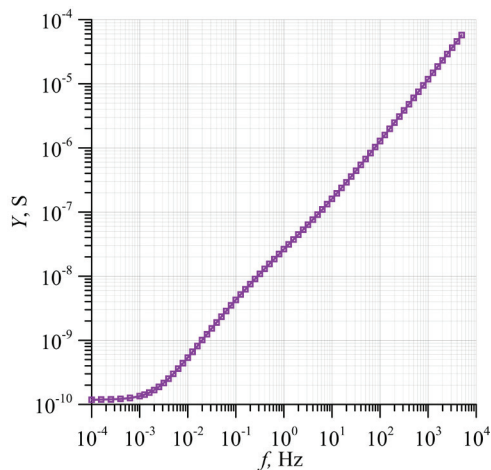

Figure 6 – Frequency dependence of the admittance of electrotechnical pressboard impregnated with transformer oil with a moisture content of 5.2 % by weight measured at 293.15 K

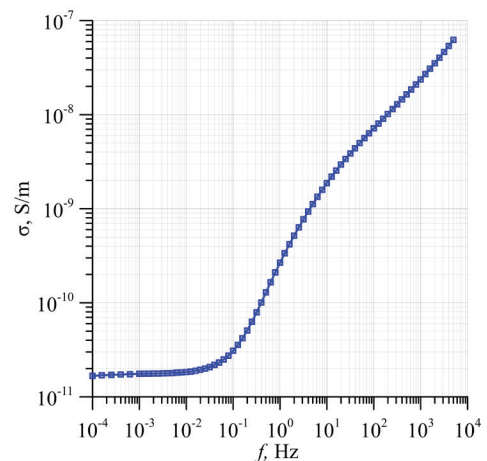

Figure 9 – Frequency dependence of the loss angle tangent of electrotechnical pressboard impregnated with transformer oil with a moisture content of 5.2 % by weight measured at 309.15 K

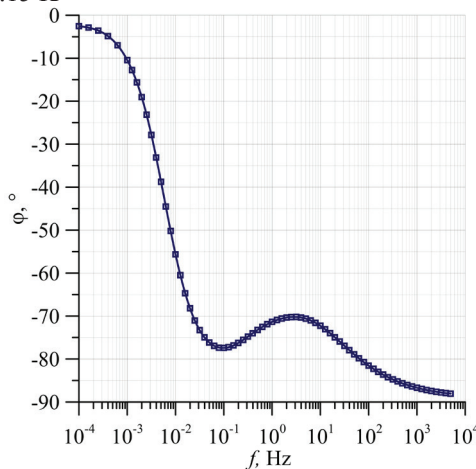

Figure 7 – Frequency dependence of the phase shift angle of electrotechnical pressboard impregnated with transformer oil with a moisture content of 5.2 % by weight measured at 301.15 K

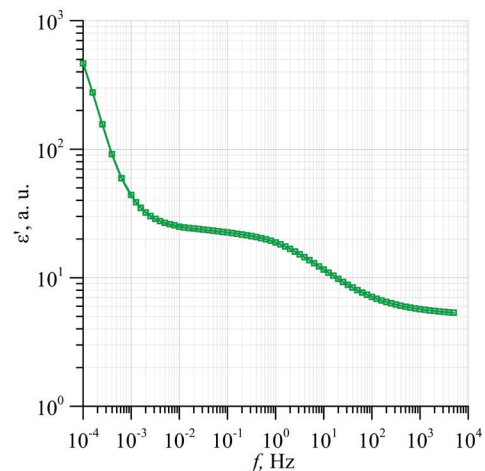

Figure 10 – Frequency dependence of the permittivity of electrotechnical pressboard impregnated with transformer oil with a moisture content of 5.2 % by weight measured at 317.15 K

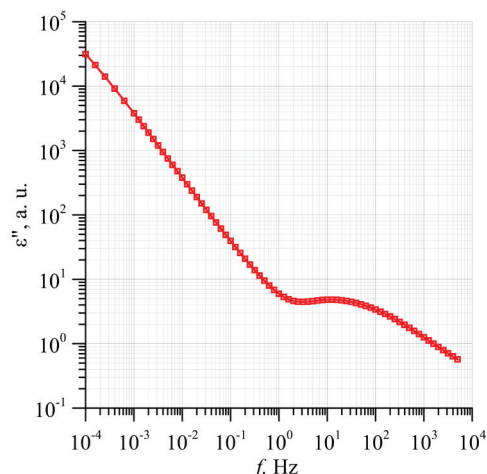

Figure 11 – Frequency dependence of the power loss coefficient of electrotechnical pressboard impregnated with transformer oil with a moisture content of 5.2 % by weight measured at 333.15 K

The shape of the polarization and depolarization current waveforms (Figure 5) is caused by the presence of the sum of two components. The first is the capacitive current that decreases with time, the second is the resistive current that is constant over time. During polarization, after charging is complete, the resistive current that is constant over time can be used to calculate the direct current conductivity. The large changes in the low frequency range visible in the phase shift angle φ (Figure 7), loss angle tangent $\text{tg}\delta$ (Figure 8), permittivity ϵ' (Figure 10) and power loss value ϵ'' (Figure 11) waveforms are caused by the relaxation processes occurring in the water nanoparticles present in the composite electrotechnical pressboard-transformer oil-water nanodrops. The reason for the significant changes in electrical parameters such as admittance Y (Figure 6) and alternating current conductivity σ (Figure 9) in the high frequency range is the phenomenon of hopping conductivity occurring between adjacent potential wells formed by water nanoparticles. The occurrence of water in the composite electrotechnical pressboard-transformer oil-water nanodrops significantly affects the direct and alternating current parameters of the material, thanks to which it is possible to determine its moisture content.

Conclusion

In the paper a new measurement stand for frequency-domain spectroscopy and polarization-depolarization current measurements of oil impregnated pressboard for different temperatures was

presented. The stand includes: climatic chamber; three electrode measuring capacitor with a sample; Omicron Dirana Frequency Domain Spectroscopy and Polarization Depolarization Current Analyzer; Agilent temperature meter with a PT100 temperature sensor; a computer with control and recording software. For the purpose of the stand a new climatic chamber was developed and made. The device allows long term temperature stabilization in range of 0 °C to 100 °C with high accuracy ± 0.01 °C. The use of three independent thermal fuses results in safety operation of the device even without on-site supervision. Equipping the chamber in USB communication with computer and by development of computer software, in combination with meters computer software, enabled fully remote control of the measuring stand. Application of new hermetical three electrode measuring capacitor lowered the chance for sample contamination.

Article presents basics of direct and alternating current material parameters analysis of composite cellulose-transformer oil-water nanodrops based on frequency-domain spectroscopy and polarization-depolarization current measurements. The use of a new climatic chamber with a higher accuracy of temperature stabilization resulted in the possibility of reducing the difference between successive measurement temperatures. Which resulted in the possibility of increasing the number of measurements in the scope of measuring temperatures. Additionally, increasing the number of measurement points per decade increased the accuracy of the measurements. Additionally, by increasing number of measurement points per decade to 10 for the frequency range from 1 mHz to 5 kHz and 5 for the frequency range from 100 uHz to 1 mHz, resulted in increase of measurements accuracy.

The paper presents results of electrical parameters measurements of the composite electrotechnical pressboard-mineral oil-water nanoparticles. The measurements were made on a sample of oil-impregnated pressboard with a moisture content of 5.2 ± 0.1 % by weight.

Acknowledgments

This research was partially supported by the Polish Ministry of Science and Higher Education as a science fund of the Lublin University of Technology, FN-28/E/EE/2020 – Researches of electrical, magnetic, thermal and mechanical

properties of modern electrotechnical and electronic materials, including nanomaterials and diagnostic of electrical devices and their components.

References

1. Żukowski P., Kołtunowicz T.N., Kierczyński K., Subocz J., Szrot M. Formation of water nanodrops in cellulose impregnated with insulating oil. *Cellulose*, 2015, vol. 22, no. 1, pp. 861–866.
DOI: 10.1007/s10570-015-0543-0
2. Zhang M., Liu J., Lv J., Chen Q., Qi P., Sun Y., Jia H., Chen X. Improved method for measuring moisture content of mineral-oil-impregnated cellulose pressboard based on dielectric response. *Cellulose*, 2018, vol. 25, no. 10, pp. 5611–5622.
DOI: 10.1007/s10570-018-1988-8
3. Zhang T., Li X., Lv H., Tan X. Parameter Identification and Calculation of Return Voltage Curve Based on FDS Data. *IEEE Trans. Appl. Supercond.*, 2014, vol. 24, no. 5, pp. 1–5. **DOI:** 10.1109/TASC.2014.2344763
4. Żukowski P., Kołtunowicz T.N., Gutten M., Janura R., Korenciak D., Sebok M. Diagnostics of transformer with insulation oil-paper. *Przegląd Elektrotechniczny*, 2015, vol. 91, no. 8, pp. 69–72 [Online]. Available: <http://pe.org.pl/articles/2015/8/18.pdf>
5. Żukowski P., Kołtunowicz T.N., Kierczyński K., Subocz J., Szrot M., Gutten M. Assessment of water content in an impregnated pressboard based on DC conductivity measurements. Theoretical assumptions. *IEEE Trans. Dielectr. Electr. Insul.*, 2014, vol. 21, no. 3, pp. 1268–1275. **DOI:** 10.1109/TDEI.2014.6832274
6. Zenker M., Kierczyński K. The influence of electric field intensity on the activation energy of the DC conductivity the electrical pressboard of impregnated with synthetic ester. In *Photonics Applications in Astronomy, Communications, Industry, and High Energy Physics Experiments*, 2017, vol. 10445, p. 104455Q.
DOI: 10.1117/12.2280735
7. Żukowski P., Kołtunowicz T.N., Kierczyński K., Rogalski P., Subocz J., Szrot M., Gutten M., Sebok M., Jurcik J. Permittivity of a composite of cellulose, mineral oil, and water nanoparticles: theoretical assumptions. *Cellulose*, 2016, vol. 23, no. 1, pp. 175–183.
DOI: 10.1007/s10570-015-0797-6
8. Żukowski P., Kołtunowicz T.N., Kierczyński K., Rogalski P., Subocz J., Szrot M., Gutten M., Sebok M. Dielectric losses in the composite cellulose-mineral oil-water nanoparticles: theoretical assumptions. *Cellulose*, 2016, vol. 23, no. 3, pp. 1609–1616.
DOI: 10.1007/s10570-016-0934-x
9. Żukowski P., Kołtunowicz T.N., Kierczyński K., Subocz J., Szrot M., Gutten M., Sebok M., Jurcik J. An analysis of AC conductivity in moist oil-impregnated insulation pressboard. *IEEE Trans. Dielectr. Electr. Insul.*, 2015, vol. 22, no. 4, pp. 2156–2164.
DOI: 10.1109/TDEI.2015.004606
10. Seifert J.M., Stietzel U., Kaerner H.C. Ageing of composite insulating materials – new possibilities to detect and to classify ageing phenomena with dielectric diagnostic tools. In *Conference Record of IEEE International Symposium on Electrical Insulation*, 1998, vol. 2, pp. 373–377.
DOI: 10.1109/elinsl.1998.694812