

**МИНИСТЕРСТВО ОБРАЗОВАНИЯ РЕСПУБЛИКИ БЕЛАРУСЬ**  
**Белорусский национальный технический университет**

**Кафедра «Английский язык №1»**

**И.Ю. Ваник**  
**С.П. Личевская**  
**М.С. Левитская**  
**О.К. Молчан**

**ENGLISH FOR PROFESSIONAL COMMUNICATION  
IN INFORMATION TECHNOLOGY**

**АНГЛИЙСКИЙ ЯЗЫК. ПРОФЕССИОНАЛЬНАЯ КОММУНИКАЦИЯ  
В ОБЛАСТИ ИНФОРМАЦИОННЫХ ТЕХНОЛОГИЙ**

**Пособие для студентов факультета информационных  
технологий и робототехники**

**Электронный учебный материал**

**Минск**  
**БНТУ**  
**2020**

Рецензенты:

кафедра английского языка естественных факультетов ФМК БГУ  
(зав. кафедрой канд. филол. наук, доц. А. Э. Черенда)

**Ваник, И. Ю.,**

English for professional communication in information technology = Английский язык. Профессиональная коммуникация в области информационных технологий : электронное пособие для студентов специальностей 1-40 01 01 Программное обеспечение информационных технологий, 1-40 05 01-04 Информационные системы и технологии в обработке и представлении информации, 1-40 05 01-01 Информационные системы и технологии в проектировании и производстве / И.Ю. Ваник, С.П. Личевская, М.С. Левитская, О.К. Молчан. – Минск: БНТУ, 2020. – 151с.

Электронное пособие направлено на обучение иноязычной профессионально ориентированной речи в области информационных технологий. Пособие состоит из 12 разделов, объединенных по тематическому принципу. Каждый раздел включает аутентичный материал для чтения, говорения, аудирования и письма. Данное пособие предусматривает использование гиперссылок и переход на справочный грамматический и видеоматериал. Широкий спектр упражнений направлен на систематизацию знаний студентов по предлагаемой тематике. Пособие можно использовать для самостоятельной аудиторной и внеаудиторной работы студентов.

Белорусский национальный технический университет  
пр-т Независимости, 65, Минск, Республика Беларусь  
Тел (017) 331-40-52  
E-mail: [engl@tut.by](mailto:engl@tut.by)  
Регистрационный № БНТУ/ФГДЭ08-

© БНТУ, 2020

© Ваник И.Ю., Личевская С.П.,  
Левитская М.С., Молчан О.К., 2020

## CONTENTS

<u>UNIT 1 IT GIANTS .....</u>	<u>4</u>
<u>UNIT 2 COMPUTER ARCHITECTURE.....</u>	<u>19</u>
<u>UNIT 3 MOBILE DEVICES.....</u>	<u>31</u>
<u>UNIT 4 OPERATING SYSTEMS.....</u>	<u>44</u>
<u>UNIT 5 DATABASE MANAGEMENT SYSTEM (DBMS).....</u>	<u>56</u>
<u>UNIT 6 GAME DEVELOPMENT.....</u>	<u>68</u>
<u>UNIT 7 ALGORITHMS. PROGRAMMING LANGUAGES .....</u>	<u>81</u>
<u>UNIT 8 ARTIFICIAL INTELLIGENCE AND NEURAL NETWORKS.....</u>	<u>94</u>
<u>UNIT 9 IMAGE RECOGNITION .....</u>	<u>105</u>
<u>UNIT 10 SOFTWARE TESTING .....</u>	<u>116</u>
<u>UNIT 11 CYBERSECURITY .....</u>	<u>129</u>
<u>UNIT 12 ROBOTICS .....</u>	<u>139</u>
<u>REFERENCES .....</u>	<u>149</u>

## UNIT 1

### IT GIANTS

#### START-UP

##### 1. Answer the questions.

1. What IT-companies do you know?
2. What are their most popular products? Which of them do you use?

#### VOCABULARY

##### 1. Match the words to their definitions.

- |                       |   |
|-----------------------|---|
| 1) peripherals        | a) relating to any of various systems which can manipulate data in a variety of forms, such as sound, graphics, or text   |
| 2) application        | b) a small flat computer that you operate by touching the screen  |
| 3) hardware           | c) devices that can be attached to computers  |
| 4) multimedia         | d) a large powerful computer which can be used by many people at the same time and which can do very large or complicated tasks.  |
| 5) podcasting         | e) the programs, routines, etc. for a computer or computer system   |
| 6) interface          | f) a service provided on the internet enabling users to search for items of interest  |
| 7) mainframe computer | g) the physical equipment used in a computer system, such as the central processing unit, peripheral devices, and memory  |
| 8) laptop computer    | h) a program enabling a user to communicate with a computer   |
| 9) search engine      | i) an insulated board or panel on which interconnected circuits and other components are mounted or printed   |
| 10) software          | j) an audio file similar to a radio broadcast, which can be downloaded and listened to on a computer, mp3 player, mobile phone, etc   |
| 11) circuit board     | k) a microcomputer small and light enough to sit on the user's lap and containing, in a single unit, a keyboard, LCD screen, microprocessor, and, usually, a rechargeable battery |

12) tablet computer

l) a piece of software designed to carry out a particular task.

**2. Match the synonyms given below.**

- |                |                       |
|----------------|-----------------------|
| 1. portable    | a. transform          |
| 2. essential   | b. buy                |
| 3. purchase    | c. prominent          |
| 4. integrate   | d. leading            |
| 5. concern     | e. look for           |
| 6. departure   | f. combine            |
| 7. preeminent  | g. keep               |
| 8. retain      | h. origin             |
| 9. ubiquitous  | i. leave              |
| 10. search for | j. integrated circuit |
| 11. feasible   | k. worry              |
| 12. genesis    | l. widespread         |
| 13. convert    | m. mobile             |
| 14. chip       | n. possible           |

**3. Complete the table with the necessary derivatives. Pay attention to the meaning of the words.**

Verb	Noun	Adjective
		productive
operate		
	competition	
apply		
		hopeful
	expression	
succeed		
	popularity	
		innovative
develop		

**READING**

**1. Read the text and answer the questions.**

1. What products does Microsoft develop?
2. What was the name Microsoft derived from?
3. When was the first fully integrated version of MS-DOS with Windows released?
4. What is Skype?

5. Microsoft retained its top position in business and consumer segments after the departure of Bill Gates, didn't it?
6. How much of worldwide online search is handled by Google?
7. What is the range of services offered by Google?
8. The name Google became ubiquitous, didn't it?
9. Is Chrome or Internet Explorer the most popular Web browser?
10. When and where was Apple set up?
11. What innovations did Apple incorporate into its computers after visiting Xerox Corporation's Palo Alto Research Center?
12. What is iTunes?
13. What does podcasting mean?
14. iPad could run all applications that were available for the iPhone, couldn't it?

## **IT Giants**

### **Microsoft**

Microsoft Corporation, leading developer of personal-computer software systems and applications. The company also publishes books and multimedia titles, produces its own line of hybrid tablet computers, offers e-mail services, and sells electronic game systems, computer peripherals (input/output devices), and portable media players.

In 1975 Bill Gates and Paul G. Allen, two boyhood friends from Seattle, converted BASIC, a popular mainframe computer programming language, for use on an early personal computer (PC), the Altair. Shortly afterward, Gates and Allen founded Microsoft, deriving the name from the words microcomputer and software. During the next few years, they refined BASIC and developed other programming languages. In 1980 International Business Machines Corporation (IBM) asked Microsoft to produce the essential software, or operating system, for its first personal computer, the IBM PC. Microsoft purchased an operating system from another company, modified it, and renamed it MS-DOS (Microsoft Disk Operating System). MS-DOS was released with the IBM PC in 1981.

In 1995 the company released Windows 95, which for the first time fully integrated MS-DOS with Windows. Microsoft also became the leader in productivity software such as word-processing and spreadsheet programs.

In its competition with Google, Microsoft moved into cloud computing, where application software and data storage are provided by centralized Internet services and are simply accessed by users through their local PCs.

In 2011 Microsoft bought the Internet voice communication company Skype.

In 2000 company cofounder Gates relinquished his role as CEO (Chief Executive Officer) of Microsoft to Steve Ballmer, whom Gates had met at Harvard University in the 1970s.

There was some concern (and some hopefulness) among industry observers that the departure of Gates would hamper Microsoft's preeminent position in the computer industry. That situation did not materialize. The company retained its top

spot in both business and consumer segments, including operating systems, productivity software, and online gaming services.

### **Google**

Google Inc., American search engine company, founded in 1998 by Sergey Brin and Larry Page that is a subsidiary of the holding company Alphabet Inc. More than 70 percent of worldwide online search requests are handled by Google, placing it at the heart of most Internet users' experience. Its headquarters are in Mountain View, California.

Google began as an online search firm, but it now offers more than 50 Internet services and products, from e-mail and online document creation to software for mobile phones and tablet computers. In addition, its 2012 acquisition of Motorola Mobility put it in the position to sell hardware in the form of mobile phones. Google's broad product portfolio and size make it one of the top four influential companies in the high-tech marketplace, along with Apple, IBM, and Microsoft. Despite this myriad of products, its original search tool remains the core of its success.

The company's name became so ubiquitous that it entered the lexicon as a verb: to google became a common expression for searching the Internet.

In 2008 Google released Chrome, a Web browser with an advanced JavaScript engine better suited for running programs within the browser.

In 2012 Chrome surpassed Microsoft's Internet Explorer (IE) to become the most popular Web browser and, as of 2017, has maintained its lead over IE, Mozilla Corporation's Firefox, and Apple Inc.'s Safari.

### **Apple**

Apple Inc., formerly Apple Computer, Inc., American manufacturer of personal computers, computer peripherals, and computer software. It was the first successful personal computer company and the popularizer of the graphical user interface. Headquarters are located in Cupertino, California.

Apple Inc. had its genesis in the lifelong dream of Stephen Wozniak to build his own computer—a dream that was made suddenly feasible with the arrival in 1975 of the first commercially successful microcomputer, the Altair 8800, which came as a kit and used the recently invented microprocessor chip. In 1976, when the Hewlett-Packard Company, where Wozniak was an engineering intern, expressed no interest in his design, Wozniak, then 26 years old, together with a former high-school classmate, 21-year-old Steven Jobs, moved production operations to the Jobs family garage—and the Silicon Valley garage start-up company legend was born. Jobs and Wozniak named their company Apple.

In 1979 Jobs had led a team of engineers to see the innovations created at the Xerox Corporation's Palo Alto (California) Research Center (PARC). There they were shown the first functional graphical user interface (GUI), featuring on-screen windows, a pointing device known as a mouse, and the use of icons, or pictures, to replace the awkward protocols required by all other computers. Apple immediately incorporated these ideas into two new computers: Lisa, released in 1983, and the lower-cost Macintosh, released in 1984.

Another innovation was a software database called HyperCard, which Apple included free with every Macintosh starting in 1987. Using a technique called hyperlinking, this program was employed by many teachers to organize multimedia elements for classroom presentations—an idea that anticipated the HTML (hypertext markup language) underpinnings of the World Wide Web.

In 2001 Apple introduced iTunes, a computer program for playing music and for converting music to the compact MP3 digital format commonly used in computers and other digital devices. Later the same year, Apple began selling the iPod, a portable MP3 player, which quickly became the market leader (the term podcasting, combining iPod and broadcasting, is used as both a noun and a verb to refer to audio or video material downloaded for portable or delayed playback).

In 2007 Apple introduced the touch-screen iPhone, a cellular telephone with capabilities for playing MP3s and videos and for accessing the Internet.

In 2010 Apple unveiled the iPad, a touch-screen device intermediate in size between a laptop computer and a smartphone. The touch screen was capable of displaying high-definition video. The iPad also had such applications as iTunes built in and could run all applications that were available for the iPhone.

Apple in 2011 introduced iCloud, a cloud computing service in which a user's applications, photographs, documents, calendars, and recently purchased music would be stored in iCloud and automatically updated in the user's other devices. In 2015 Apple introduced a smartwatch, the Apple Watch.

## **2. Read the text again and choose whether these statements are true or false.**

1. Microsoft is a world-famous producer of consumer electronics.
2. The first PC with MS-DOS was released in 1981.
3. Microsoft also became the leader in productivity software such as word-processing and spreadsheet programs.
4. The departure of Gates hampered Microsoft's preeminent position in the computer industry.
5. More than 70 percent of worldwide online search requests are handled by Google.
6. Google specializes only in online search.
7. Google's broad product portfolio and size make it one of the top four influential companies in the high-tech marketplace.
8. The company's name became so ubiquitous that it entered the lexicon as a verb.
9. Apple is a British manufacturer of personal computers, computer peripherals, and computer software.
10. In 1976 Stephen Wozniak and Steven Jobs created Apple in the Jobs family garage.
11. Hyperlinking was employed by many teachers to organize multimedia elements for classroom presentations.
12. In 2005 Apple introduced iTunes.



13. Cloud computing is a service in which a user's applications, photographs, documents, calendars, and recently purchased music would be stored in iCloud and automatically updated in the user's other devices.

**3. Find in the text what these abbreviations stand for.**

IBM, PC, MS-DOS, CEO, IE, PARC, GUI, HTML.

**4. Make a short summary of the text.**

## LANGUAGE FOCUS

### *MULTIFUNCTIONAL VERBS*

**Consult grammar rule using the link:**

[https://drive.google.com/file/d/1mcHix230UJazmsO4cFQVzHr6\\_6QWLMjw/view?usp=sharing](https://drive.google.com/file/d/1mcHix230UJazmsO4cFQVzHr6_6QWLMjw/view?usp=sharing)

**1. Complete the sentences with the verb *to be* in the correct form.**

1. Microsoft Corp. \_\_\_\_ founded by Bill Gates and Paul Allen in 1975.
2. More than 70 percent of worldwide online search requests \_\_\_\_ handled by Google.
3. I \_\_\_\_ working on my science project at the moment.
4. In November 1980, IBM \_\_\_\_ looking for software that would operate their upcoming PC and approached Microsoft.
5. Ivan wants \_\_\_\_ a software developer when he leaves school.
6. All workers \_\_\_\_ to wear uniform.
7. \_\_\_\_ quiet! I can't hear what they \_\_\_\_ saying.
8. Who \_\_\_\_ in charge of the Microsoft Cloud team?
9. Next year our company \_\_\_\_ a participant of the TIBO IT Forum.
10. The online search engine Google \_\_\_\_ one of the most successful sites on the Internet.

**2. Use the words in the box to complete the sentences and make any necessary changes.**

<b>to be interested, to be responsible, to be available, to be designed, to be created, to be compatible, to be recognized, to be called</b>
--

1. Famous pioneers of technology including Steve Jobs, Bill Gates, Mark Zuckerberg and other brilliant minds \_\_\_\_ for shaping the world we live in.

2. In 1989, Microsoft introduced Microsoft Office which \_\_\_\_\_ with all Microsoft products. Technology companies have a unique advantage over other businesses, and it \_\_\_\_\_ the network effect.
3. Both Steve Jobs and Steve Wozniak \_\_\_\_\_ in electronics.
4. Every Apple product \_\_\_\_\_ to protect your personal information.
5. In 2016, Bill Gates and his wife Melinda \_\_\_\_\_ for their philanthropic work.
6. Google also developed innovative features that \_\_\_\_\_ (not) on Facebook.
7. The consortium of dozens of technology and mobile telephone companies \_\_\_\_\_ in order to develop and promote Android.

**3. Complete the sentences with the verb *to have* in the correct form.**

1. At school both Bill Gates and Paul Allen \_\_\_\_\_ common enthusiasm for computers.
2. The cloud \_\_\_\_\_ some built-in advantages.
3. You \_\_\_\_\_ to undertake a series of tests for this project.
4. For 40 years, Apple \_\_\_\_\_ helped teachers unlock the creative potential in every student.
5. When students \_\_\_\_\_ more ways to express ideas, it changes how they think.
6. Bill Gates \_\_\_\_\_ to adapt the new software to work for the IBM PC.
7. You \_\_\_\_\_ already \_\_\_\_\_ lots of opportunities to do the project.
8. As you're driving, you \_\_\_\_\_ (not) to worry about missing messages with the Android Auto app.
9. YouTube \_\_\_\_\_ a great deal of resources to help people advance their careers, prepare for new jobs or grow their businesses.
10. Today we are \_\_\_\_\_ so much work to do.

**4. Complete the sentences with the verb *to do* in the correct form.**

1. Whether you're taking a photo, or getting directions, you can \_\_\_\_\_ it knowing that Apple \_\_\_\_\_ (not) gather your personal information.
2. When \_\_\_\_\_ Sergey Brin and Larry Page found Google?
3. What \_\_\_\_\_ Google specialize in?
4. Research shows that more than 65 percent of today's students will work in jobs that \_\_\_\_\_ (not) even exist yet.
5. The test is well \_\_\_\_\_.
6. Microsoft is constantly \_\_\_\_\_ research in the field of intelligent search tools.
7. Microsoft Dynamics 365 will help the company focus on \_\_\_\_\_ what it \_\_\_\_\_ best: assisting customers more productively.
8. The cloud solution opens the doors to future use-cases which \_\_\_\_\_ (not) even exist today.
9. What \_\_\_\_\_ Azure Machine learning service enable data scientist to \_\_\_\_\_?
10. Apple revolutionized personal technology with the introduction of the Macintosh in 1984, \_\_\_\_\_ it?

**5. Choose the right option.**

1. In 1976, when Steve Jobs \_\_\_\_\_ just 21, he and Steve Wozniak started Apple Computer in the Jobs' family garage.

- a) were
- b) was
- c) has been

2. We \_\_\_\_\_ looking for a technology partner.

- a) am
- b) is
- c) are

3. Apple \_\_\_\_\_ a multigenerational company with employees from 18 to 85.

- a) been
- b) am
- c) is

4. I \_\_\_\_\_ a director of this school for ten years.

- a) has been
- b) have had
- c) have been

5. Cortana, your personal digital assistant, \_\_\_\_\_ access to your search and browsing history.

- a) is
- b) have
- c) has

6. 95 Apple ConnectED schools \_\_\_\_\_ received upgrades to their wireless networks since 2014.

- a) have
- b) were
- c) has

7. Every Apple product \_\_\_\_\_ designed to \_\_\_\_\_ simple and usable.

- a) have, have
- b) is, do
- c) is, be

8. Google \_\_\_\_\_ and always \_\_\_\_\_ an engineering company that thinks big and takes risks.

- a) is, will be
- b) was, does

c) have been, be

9. At Google, we're \_\_\_\_ more than just training, we want to help people put new digital skills to use.

- a) being
- b) having
- c) doing

10. Last year, over 95 billion apps \_\_\_\_ downloaded globally from Play app store.

- a) are
- b) were
- c) have been

## 6. Correct the mistakes.

1. Google was invested billions of dollars over the last decade to make Android what it was today.
2. Phone makers doesn't have to include Google services on their wide range of devices.
3. Today 29% of leaders at Apple were women.
4. Every Apple device are made with incredible attention to every detail throughout the production process.
5. Cyberattacks on manufacturers have increasing in number in recent years.
6. In the past, there was some reasons why multidisciplinary optimization could not be do.
7. Steve Jobs returned to Apple in 1997, wasn't he?
8. What does recent advances in computer processing allow manufacturers to do?
9. Engineers need the ability to have productive whenever they be.
10. Apple's facilities is powered by 100 percent renewable energy.

## SPEAKING

Here is an extract from the motivation speech Steve Jobs, chief executive officer (CEO) and co-founder of Apple Computer and of Pixar Animation Studios, is giving to graduate students at Stanford University. He is making recommendation to pursue their dreams and see the opportunities in life's setbacks (неудачи).

### 1. Study the words that might prove useful:

1.drop out	бросить учебное заведение, выбыть
2.drop in	зайти, заглянуть, (зд. посещать)
3.a drop-in	студент со свободным посещением
4.required	обязательный

5. tuition	обучение
6.a temple	храм
7.stumble into	натолкнуться на, (случайно встретиться, найти)
8. a typeface	гарнитура (очертания) шрифта
9.a font	шрифт
10 gut	(зд.) внутреннее чувство, интуиция
11.destiny	судьба

**Notes:**

Mind the difference between **typeface** and **font**?. In brief: **a font** is what you use, **a typeface** is what you see.

**2. Read through your passage (A or B).**

2.1. Put down questions in the 3<sup>rd</sup> person singular to find out the missing information and complete the lines.

2.2. Work in pairs A and B. Ask each other the questions you have made; your partner knows the answer. Let Student A start. Complete the extract from your worksheet.

**Student A**

The story is about (1).....  
 When I was 17, I went to (2) ..... College that was almost as expensive as Stanford University. My working-class parents had to spend all their savings on (3) ..... . After six months, I decided to drop out because (4) ..... . As soon as I did it, I stopped taking the required classes and began dropping in on (5)..... . That time was pretty hard as I didn't have accommodation, so I slept (6) ..... . I returned Coke bottles for the 5¢ deposits to buy food with. I had to walk 7 miles across town every Sunday night to get one good meal a week at the (7)..... . But looking back, it was one of the best decisions I ever made because much of what I stumbled into by following my curiosity and intuition turned out to be priceless later on.

Reed College at that time offered the best calligraphy instruction in the country. I decided to take a calligraphy class to learn how to do this. I learned about (8)..... , about varying the amount of space between different letter combinations, about what makes great typography great. It all came back to me 10 years later, when we (9)..... . And we designed it all into the Mac: multiple typefaces and proportionally spaced fonts. Mac was the first computer that had beautiful typography which was then copied by Windows. If I had never dropped out of college and had never dropped in on

this calligraphy class, personal computers might not have the wonderful typography that they do.

You can't connect the dots looking forward; you can only connect them looking backward. So you have to trust that the dots will somehow connect in your future. This approach has never let me down, and it has made all the difference in my life.

**Student B**

The story is about connecting the dots.

When I was (1) ..... years old, I went to Reed College that was almost (2) ..... . My working-class parents had to spend all their savings on tuition. After (3) ....., I decided to drop out because I had no idea what I wanted to do with my life. As soon as I did it, I stopped taking (3) ..... classes and began dropping in on the ones that looked interesting. That time was pretty hard as I (4) ....., so I slept on the floor in friends' rooms. I (6) ..... for the 5¢ deposits to buy food with. I had to walk 7 miles across town every Sunday night to get one good meal a week at the Hare Krishna temple. But looking back it was one of the best decisions I ever made because much of what I stumbled into by following my curiosity and intuition turned out to be priceless later on.

Reed College at that time offered (7) ..... in the country. I decided to take a calligraphy class to learn how to do this. I learned about serif and sans serif typefaces, about (8) ....., about what makes great typography great. It all came back to me 10 years later, when we were designing the first Macintosh computer. And we designed it all into the Mac: (9) ..... . Mac was the first computer that had beautiful typography which was then copied by Windows. If I had never dropped out of college and had never dropped in on this calligraphy class, personal computers might not have the wonderful typography that they do. You can't connect the dots looking forward; you can only connect them looking backward. So, you have to trust that the dots will somehow connect in your future. This approach has never let me down, and it has made all the difference in my life.

2.3. Now, have you understood what *connecting the dots* means?

3. Discuss with your partner(s) if you agree or disagree with the following statement: *We learn when we fail.* Comment on this statement. Make use of the phrases from the table to ask for and provide an opinion.

<b>Opinions and agreeing or disagreeing</b>			
<b>Asking for opinions</b> What do you think?	<b>Giving your opinion</b> I think ... In my opinion ...	<b>Agreeing</b> I agree with that because ... I think so too.	<b>Disagreeing</b> I'm afraid I don't agree. I can't agree with

How do you feel about this? What's your opinion of ...?	In my view ... It seems to me that ... I would say that ...	I think that's true for another reason... Yes, that's right. Yes, and also because...	that. I can't go along with that. That's true, but ...
--	---	---	--

## WRITING

Write a passage in the third person singular. Use the information you have learned about Steve Jobs.

You can watch the full video here: Stanford University channel on YouTube: <http://www.youtube.com/stanford>

## LISTENING

### SETTING THE CONTEXT

1. What do you know about Google? When and by where was it founded?
2. Google products are designed to help you work and play, stay organized, get answers, keep in touch, grow your business, and more. How often do you personally use Google products? What are your favorite ones?

### ACTIVATING VOCABULARY

Match the English words (phrases) with their Russian equivalents.

1. campus	a. стажер
2. incredible	b. искать решение какой-либо задачи с помощью техники "мозгового штурма"
3. complexity	c. территория университета
4. efficiency	d. сложность; запутанность
5. perspective	e. эффективность; продуктивность, производительность
6. responsibility	f. ответственность
7. to brainstorm	g. перспектива, ракурс; вид на будущее
8. an intern	h. невероятный, удивительный

### FOCUSING ON PHRASAL VERBS

Study the following phrasal verbs. Then, use these verbs to make 3 sentences about yourself:

<i>Phrasal Verb</i>	<i>Definition</i>	<i>Example Sentence</i>
---------------------	-------------------	-------------------------

<i>to switch over to sth.</i>	<i>to start doing something new or different</i>	<i>And then I switched over to working in Intelligence.</i>
<i>to take off</i>	<i>1) (of an aircraft) to leave the ground and fly 2) to become successful or popular very fast</i>	<i>And I grew up watching the shuttles take off from the Kennedy Space Centre. Her business has really taken off.</i>

**Before proceeding to CHECKING YOUR UNDERSTANDING section, please follow the link to watch the video: <https://www.youtube.com/watch?v=9No-FiEInLA>**

### ***CHECKING YOUR UNDERSTANDING***

**Choose the correct alternative.**



1. “The atmosphere around Google, it's definitely very \_\_\_\_”.
  - employee-centric
  - academic
  - toxic
  - joyful
  
2. \_\_\_\_ is currently working on an email notification for Google Accounts.
  - Paola Correa
  - Kim Day
  - Matt Malone
  
3. Grant Oakley’s code helps developers test their code and that way, the developers can \_\_\_\_
  - write good stable code for Google products.
  - identify and eliminate bugs early in the software development process.
  - have more days of paid vacation.
  
4. Florian Koenigsberger: “If this is what being an intern feels like, \_\_\_\_
  - I’d never want to be an intern in my life.”
  - I'd love to be an intern for the rest of my life.”
  - none of the above.
  
5. According to Paola Correa, the week has been quite \_\_\_\_
  - uneventful.
  - unstoppable, restless, a bunch of activities.

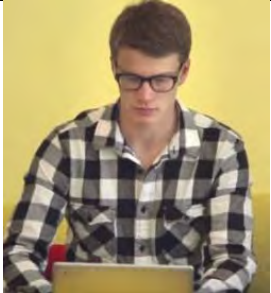
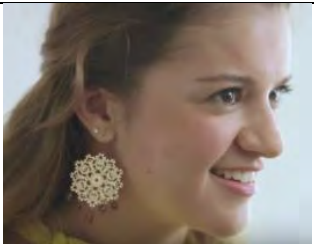

6. Matt Malone: I'm working in the \_\_\_\_
- Online Help Center.
  - Advertising Department.
7. Interns at Google are \_\_\_\_
- at the bottom of the knowledge totem pole.
  - given much more responsibility than expected.
  - doing the most challenging work.
8. At Google you don't necessarily have to know everything \_\_\_\_
- but you have to be willing to learn.
  - you just need to know where to find it, when you need it.
  - but you should know how to brainstorm.

**Watch the video again and match an intern with his/her background and reasons to join Google:**

 <p><b>FLORIAN KOENIGSBERGER</b></p>	<p>a former military</p>	<p>always wanted to work with technology</p>
 <p><b>GRANT OAKLEY</b></p>	<p>Melbourne, Florida</p>	<p>is a graduate in Consumer Operations at Google</p>
 <p><b>PAOLA CORREA</b></p>	<p>Spokane, Washington</p>	<p>loves coding</p>

 <b>MATT MALONE</b>	New York City	thinks that Google is more than just a tech company
 <b>KIM DAY</b>	the University of Miami	studied advertising and marketing

**Answer the following questions.**

1. What does the campus look like?
2. Are the interns treated differently from other employees?
3. How much responsibility do they have?
4. Does Google look like a good place to work at? Why (not)?
5. What's Googliness in your opinion?
6. What do all the interns have in common?

## UNIT 2

### COMPUTER ARCHITECTURE

#### START-UP

##### 1. Answer the questions.

1. What computer do you use: a desktop or a laptop?
2. How does a computer help you?

##### 2. Look at a diagram illustrating the main components of a computer. Then find information about the function of each component.

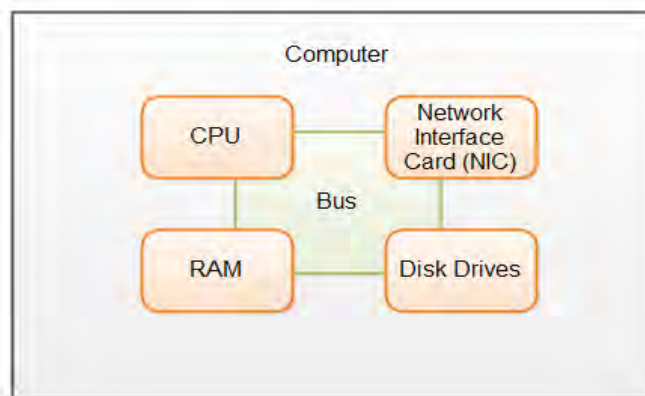

#### VOCABULARY

##### 1. Match the words to their definitions.

- |                |   |
|----------------|---|
| 1) data        | a) the mechanism that handles the reading, writing, and storage of data on the hard disk  |
| 2) to store    | b) a piece of equipment which allows access to other computers or networks, for example the internet  |
| 3) to retrieve | c) a computer program that allows easy entry and manipulation of figures, equations, and text, used esp. for financial planning and budgeting |
| 4) to process  | d) a piece of electronic equipment inside a computer which allows it to receive and show pictures and video                                   |
| 5) to browse   | e) the physical equipment used in a computer system, such as the central processing unit, peripheral devices, and memory                      |
| 6) spreadsheet | f) find or extract (information stored in a computer)   |

- |                   |  |
|-------------------|--|
| 7) to withdraw    | g) to search for information in computer files or on the Internet, especially on the World Wide Web  |
| 8) hardware       | h) to remove something or take it away   |
| 9) router         | i) to keep and save information in a digital device  |
| 10) graphics card | j) to perform mathematical and logical operations on data according to programmed instructions in order to obtain the required information |
| 11) hard drive    | k) information in electronic form that can be stored and used by a computer  |

**2. Match the synonyms given below.**

- |                   |                   |
|-------------------|-------------------|
| 1) to manipulate  | a) suitable       |
| 2) to store       | b) to surf        |
| 3) to browse      | c) to transform   |
| 4) to be composed | d) to handle      |
| 5) delicate       | e) to keep        |
| 6) to access      | f) fragile        |
| 7) to convert     | g) to consist     |
| 8) appropriate    | h) to be admitted |

**3. Complete the table with the necessary derivatives. Pay attention to the meaning of the words.**

Verb	Noun	Adjective
convert		
	manipulation	
		protective
include		
		combined
	usage	
		creative
compose		
	presentation	
		specific

**READING**

**1. Read the text and answer the questions.**

1. What functions does a computer perform?
2. What are main elements of a computer?
3. What peripherals can be connected to a computer?

## A Typical Computer

A computer is an electronic device that manipulates information, or data. It has the ability to store, retrieve, and process data. You can use a computer to type documents, send email, play games, and browse the Web. You can also use it to edit or create spreadsheets, presentations, and even videos.

When most people hear the word computer, they think of a personal computer such as a desktop or laptop. However, computers come in many shapes and sizes, and they perform many different functions in our daily lives. When you withdraw cash from an ATM, scan groceries at the store, or use a calculator, you're using a type of computer.

A typical computer system consists of both hardware and software. The hardware is composed of the electronic and mechanical devices, while software refers to the data and instructions that allow the computer to perform specific functions.

A complete computer system includes a computer system unit, software and peripheral devices such as a central storage system, keyboard, mouse, monitor, printers, scanners and routers. A computer system unit refers to the enclosure for all the internal components of a computer. It is also called a computer tower or computer case, and it protects delicate hardware parts from the external environment.

The combination of hardware and software enables a computer to receive inputs, process them and produce specific outputs. Hardware components are the physical objects that comprise a computer, and include the hard drive disk, graphics cards, motherboards and chips. Software includes programs that allow users to do word and data processing.

Modern computers receive data from several components. A modem enables the computer to access information from the Internet, while the keyboard and mouse submit instructions. Data can also be obtained from peripherals, such as CD and DVD drives and USB memory sticks. The computer's central processing unit processes input data and converts it into appropriate code.

### **2. Read the text again and say whether these statements are true or false.**

1. Computers are mainly desktops and laptops.
2. A typical computer system consists of both hardware and software.
3. The enclosure is used to protect delicate hardware parts from the external environment.
4. Hardware components allow users to do word and data processing.
5. Data in computers can be obtained from peripherals.

### **3. Make a short summary of the text.**

## LANGUAGE FOCUS

### QUESTION TYPES

Consult grammar rule using the link:

<https://drive.google.com/file/d/1-jg-xUHkRfMELgFnqWxiSW5COrOhQPt9/view?usp=sharing>

**1. Match the question with the appropriate answer and comment on the question type.**

1. Is RAM cleared completely when the computer system shuts down?	a. Actually, it does.
2. What devices does the computer system use to display information?	b. Yes, they are.
3. Does the CPU handle instructions?	c. I suppose, octa-core processors are more common.
4. Processors are becoming more and more powerful, aren't they?	d. It's any input device.
5. Are dual-core or octa-core processors more common?	e. Because Apple teams collaborate with each other.
6. What piece of computer hardware is used to provide data into the system?	f. Yes, it is.
7. Why do all the components of iPhone work together efficiently and beautifully?	g. There is main memory consisting of ROM and RAM and backing stores which can be internal, eg. a hard disk or SSD, or external, eg. a USB flash drive.
8. Can you tell me what types of storage a computer uses?	h. These are output devices.

**2. Arrange the words in the correct order to make questions.**

1. What / used / devices / to input / are / sound?
2. A keyboard / input / an automatic / is / or / device / manual?
3. You / back up / how often / your / important / do / data?
4. Retains / of memory / its data / what kind?
5. Inputs / are / outputs / both / and / touchscreens / aren't they?
6. Contain / processor / does / quad-core / or / your computer / octo-core?
7. Did / the first / appear / when / microprocessor?
8. Smartphones / a phone screen / what / use / do / technology / to unlock?

9. Are / for / storage / used / what / devices?
10. When / return / to Apple / did / Steve Jobs?

### 3. Rewrite the sentences as General questions.

1. Microsoft is doing research in the field of intelligent search tools.
2. The invention of the computer has had a huge impact on our day-to-day lives.
3. The internal storage of a computer can use a solid state drive (SSD).
4. Scanners are often incorporated into printers.
5. The iPhone started the internet-connected, portable computing age we live in now.
6. The Apple Watch quickly became the most popular smartwatch on the market.
7. There are two main components to every processor.
8. With Windows10 you'll view up to four apps and all open tasks at one time.

### 4. Add a tag to each sentence.

1. You can operate your ultrabook remotely from your smartphone, \_\_\_\_\_?
2. 3D camera delivers more natural 3D vision in video calls, \_\_\_\_\_?
3. With the new laptop users get multitouch display options, \_\_\_\_\_?
4. Technology has changed significantly since the early days of the Internet, \_\_\_\_\_?
5. Organizations around the world are transforming for the digital era, \_\_\_\_\_?
6. A desktop computer isn't portable, \_\_\_\_\_?
7. The advanced Face ID will allow you to unlock your iPhone with a glance, \_\_\_\_\_?
8. Max bought a genuine Apple power adapter, \_\_\_\_\_?
9. You have to upgrade your Mac to the latest macOS Mojave, \_\_\_\_\_?
10. CPUs aren't only found in desktop or laptop computers, \_\_\_\_\_?

### 5. Make indirect questions using the prompts in brackets. Answer the questions.

1. Is ROM volatile or non-volatile type of memory? (I wonder if ...)
2. How often do you back up data? (Could you tell me ...)
3. How long will RAM hold data? (Do you know ...)
4. When did two Stanford Ph.D. students launch Google? (Have you any idea ...)
5. What Google product do people use to find their way? (Can you tell me ...)
6. Is Google Assistant integration with audiobooks available on Android phones? (I wonder if ...)
7. What new machine learning-powered feature has Google incorporated in Gmail to help complete sentences in emails? (Do you know ...)
8. What is the boot time of your PC? (Can you tell me ...)
9. What kind of processor do you have in your computer? (I wonder...)

10. Can phone makers modify Android in any way they want? (Have you any idea if ...)

**6. Think of the questions to the following sentences.**

1. The most common manual input devices are the keyboard and mouse. (What?, Alternative question, Tag question)
2. Apple created the app revolution with the launch of the AppStore in 2008. (General question, What?, When?)
3. RAM is made up of small memory chips. (What?, What?, Tag question)
4. A program gets loaded from the hard drive into the RAM. (General question, Where?, Tag question)
5. Pavel deleted some video files to free up storage space for new data. (Who?, Why?, Tag question)
6. Memory sticks can hold large quantities of data. (General question, What?, Alternative question)
7. CPUs with multiple cores have more power to run multiple programs at the same time. (What kind of ?, General question, Tag question)
8. AirPods deliver an industry-leading 5 hours of listening time on one charge. (General question, How many?, Alternative question)
9. The new Apple campus will be powered by 100 percent renewable energy. (General question, What?, Tag question)
10. Apple Watch has empowered people with more information about their health. (General question, What?, What kind of?)

**SPEAKING**

1) Find out information about your partner's computer performance features. Before that, make sure you understand the following notions

1. touch ID	идентификация на основе отпечатка пальца
2. processor speed	скорость передачи данных
3. RAM (random access memory)	«оперативка»
4. resolution	разрешение (четкость изображения, общее количество пикселей на экране монитора)

2) Now make questions about the following items with the help of the prompts given. Put words in the correct order to make a question.

1. Computer type	what / computer / is / type / it?
2. Processor speed	of / is / processor / what / speed / the / the?



3. Touch ID	it / have / Touch ID / does?
4. Memory type	what / RAM / have / does / type / it?
5. Hard disk type	type / is / hard / the / disk / what?
6. Monitor type	monitor / does / have / what / it/ kind?
7. CD/DVD-ROM	CD/DVD-ROM / it / does / have/ a?
8. Processor type	type / what / processor / it / does / have?
9. Number of cores	are / cores / there / how many?
10.Memory (RAM)	what size /of/ memory / does / random / access / it / have?
11.Hard disk capacity	what / the hard disk / is /of / the capacity?
12.Monitor size	big / the / monitor (display) /is / how?
13.Monitor resolution	does / resolution / what / the / display / have?

### STUDENT A

a) Study your computer performance features.

Match lines in the description below with the appropriate item from task 2. You will have to answer Student B's questions about your computer.

#### Student A's computer details:

##### *Desktop*

2.3GHz dual-core Intel Core i5 processor

Turbo Boost up to 3.6GHz

8GB or 16GB DDR4 SDRAM

1TB 5400-rpm hard drive; 1TB Fusion Drive; or 256GB SSD

Intel Iris Plus Graphics 640

21.5-inch (diagonal) LED-backlit display

Widescreen display

1920 by 1080 pixels

320 nit brightness

Standard color (sRGB)

1000:1 contrast ratio

b) Ask Student B questions you have made in task 2 about their computer

### STUDENT B

a) Study your computer performance features.

Match the lines in the description below with the appropriate item from task 2. You will have to answer Student A's questions about your computer.

**Student B's computer details:**

***Portable laptop***

Touch ID

Eighth-generation Intel dual-core processor

1.6GHz dual-core Intel Core i5 processor

Turbo Boost up to 3.6GHz

0.16 to 0.61 inch thin

8GB or 16GB memory

128GB, 256GB, 512GB, or 1.5TB SSD

Intel UHD Graphics 617

13.3-inch (diagonal) LED-backlit display with IPS technology

Retina display

2560 by 1600 pixels

300 nit brightness

Full standard color (sRGB)

Up to 12-hour wireless web

Integrated 50.3-watt-hour lithium-polymer battery

30W USB-C Power Adapter

b) Ask Student A questions you have made in task 2 about their computer.

**WRITING**

Write about your partner's computer making use of both the information you have just got and prompts below.

... is packed with...;

... is equipped with...;

... reaches the speed of...;

... has a resolution of...;

... goes right to the edge of the enclosure;

... use your fingerprint to access locked documents, notes and system settings;

... lets you launch apps in a flash;

... lets you work with multiple apps open;

... provides plenty of room for all your documents, photos, and videos;

... ready to play for up to ... hours;

... most colorful Retina display;

... a high-capacity hard drive;

...the latest graphics technologies / ...the latest high-performance graphics.

You can start in the following way:

*My partner's desktop.....*

*My partner's notebook .....*

## LISTENING

### *SETTING THE CONTEXT*

1. Why are programs saved in a different format than the human readable programming languages that they are written in?
2. What are some of the programs that your computer is running even when you're not touching it?
3. What are some of the things your computer needs to know in order to respond properly to a mouse click?

### *ACTIVATING VOCABULARY*

**Match the words with their definitions:**

1. to capture	a) to stop the continuous progress of (an activity or process)
2. to shrink down	b) to take into one's possession or control by force
3. measurement	c) an application, or a component of an interface, that enables a user to perform a function or access a service.
4. to execute	d) the size, length, or amount of something, as established by measuring.
5. to interrupt	e) to put (a plan, order, or course of action) into effect; carry out an instruction or program.
6. widget	f) to decrease in size, range, or extent

**Before proceeding to CHECKING YOUR UNDERSTANDING section, please follow the link to watch the video:**

<https://www.youtube.com/watch?v=AkFi90lZmXA>

### *CHECK YOUR UNDERSTANDING*

**Choose the best answer to these questions.**

1. The BIOS is most like the computer's

A brain

- B eyes and hands
- C stomach
- D lungs
- E none of the above

**2. The CPU can handle \_\_\_\_\_ of instructions a second**

- A thousands
- B millions
- C billions
- D gazillions
- E none of the above

**3. Programs are encoded and stored in memory as**

- A 1's and 0's
- B raw text
- C HTML
- D electrons
- E all of the above

**4. The CPU's job is**

- A to store information
- B to deal with input and output from peripherals
- C to edit files in memory
- D to fetch and execute instructions
- E all of the above

**5. The critical components of your computer's architecture are:**

- A wires, plastic, silicon
- B programs, bits, bytes, HTML
- C peripherals, BIOS, CPU, programs, memory
- D mouse, motherboard, integrated circuits, wires
- E none of the above

**6. BIOS stands for**

- A Biological Input Operating System
- B Basic Input Output System
- C Basic Integer Operating System
- D Basic Input Output Software

E none of the above

**Research shows that people often say frequently used expressions very fast, and so they can be difficult to catch. Follow the link, listen and fill the gaps with frequently used two-word expressions.**

...That between the mouse click  video playing, there was something that captured your intention, understood it. Is it gremlins? Let's imagine that we can shrink down  size of an electron and inject ourselves into a click  mouse.  took your mouse apart, you'd see that it's really a very simple machine. It has a couple buttons  system for detecting motion and distance. You might have an optical mouse that makes these measurements with lights and sensors, but older ones did this  hard rubber ball and some plastic wheels. Same concept. When you click the button on your mouse, it sends a message  computer with information about its position. When your mouse click is received, it's handled  basic input/output subsystem. This subsystem acts like the eyes and  ears and mouth and hands  computer. Basically, it provides a way  computer to interact with its environment. But it also acts like a buffer. In this case, the I/O subsystem decides that your mouse click is pretty important, so it generates an interrupt  CPU. "Hey, CPU! Got a click here. "The CPU, or central processing unit,  brains  whole computer. Just like your brain doesn't take up your whole body, the CPU doesn't take up the whole computer, but it runs the show all .  CPU's job, its whole job, is fetching instructions from memory and executing them, billions of instructions a second. Yes, billions every second: instructions to move your mouse around  screen, to run that clock widget on your desktop, play your internet radio, manage the files you're editing  hard drive, and much, much more. Your computer's CPU is one heck  multitasker! "But oh my gosh, there's a very important mouse click. Let's drop everything now and  deal  with  that!" There are programs for everything  CPU does. A special program  mouse,  clock widget,  internet radio, and for dealing with letters sent  keyboard. Each program was initially written by a human  human-readable programming language, like Java, C++, or Python.

But human programs take up [ ] of space and contain [ ] of unnecessary information [ ] computer, so they are compiled and made smaller and stored in bits of ones and zeros in memory. The CPU realizes that it needs instructions for how to deal with this mouse click, so it looks up the address [ ] mouse program and sends a request [ ] memory subsystem for instructions stored there. Each instruction [ ] mouse device driver is duly fetched and executed. And that's not nearly the end [ ] story! Because the CPU learns [ ] mouse was clicked when the cursor was over a picture [ ] button [ ] monitor screen, and so, the CPU asks memory [ ] monitor program to find out what that button is. And then the CPU has to ask memory [ ] program [ ] button, which means [ ] CPU needs the monitor program again to show the video associated [ ] button, and so it goes. And let's just say there are [ ] of programs involved before you even see the button [ ] screen light up when you clicked it. So, just the simple task of clicking your mouse means visiting all [ ] critical components of your computer's architecture...

## UNIT 3 MOBILE DEVICES

### START-UP

#### 1. Answer the questions.

1. Do you think a good modern smartphone can function as a computer?
2. What are the most important features that you take into account when choosing a portable device?

### VOCABULARY

#### 1. Match the words to their definitions.

- |                     |   |
|---------------------|---|
| 1) to host          | a) a computer screen that allows the user to give commands to the computer by touching parts of the screen rather than by using a keyboard or mouse |
| 2) to synchronize   | b) a device like a pen with which you can input written text or drawing directly into a computer  |
| 3) extension        | c) a display of information on a screen, which uses liquid crystals that become visible when electricity is passed through them                     |
| 4) touchscreen      | d) to store a website or other data on a server so that it can be accessed over the Internet  |
| 5) LCD              | e) lengthening, stretching out, or enlarging the scope of something   |
| 6) stylus           | f) to occur at the same time or coincide or agree in time   |
| 7) flash memory     | g) A headset that provides a two-way connection to the user's cellphone via Bluetooth   |
| 8) cloud storage    | h) a technology that allows computers, mobile phones and other devices to communicate with each other without being connected by wires              |
| 9) wireless headset | i) an electronic (solid-state) non-volatile   |

computer storage medium that can be electrically erased and reprogrammed

10) bluetooth

j) a model of computer data storage in which the digital data is stored in logical pools

**2. Match the synonyms given below.**

- |                 |                   |
|-----------------|-------------------|
| 1) broad        | a) cordless       |
| 2) to replace   | b) to combine     |
| 3) remotely     | c) characteristic |
| 4) handheld     | d) wide           |
| 5) to integrate | e) distantly      |
| 6) intermediate | f) to change      |
| 7) to displace  | g) portable       |
| 8) feature      | h) to supersede   |
| 9) external     | i) medium         |
| 10) wireless    | j) outer          |

**3. Complete the table with the necessary derivatives. Pay attention to the meaning of the words.**

Verb	Noun	Adjective
extend		
	function	
enable		
		descriptive
define		
	comparison	
		wearable
communicate		
		collective
	variety	

**READING**

**1. Read the text and answer the questions.**

1. What functions can modern mobile devices perform?
2. What devices does the category of mobile devices include?
3. Name the features of tablets.
4. What are smartwatches used for?



## **Modern Mobile Devices**

Today's mobile devices are multifunctional devices capable of hosting a broad range of applications for both business and consumer use. Smartphones and tablets enable people to use their mobile device to access the Internet for email, instant messaging, text messaging and Web browsing, as well as work documents, contact lists and more.

Mobile devices are often seen as an extension to your own PC or laptop, and in some cases newer, more powerful mobile devices can even completely replace PCs. And when the devices are used together, work done remotely on a mobile device can be synchronized with PCs to reflect changes and new information while away from the computer.

### **Types of Mobile Computing Devices**

The term mobile device refers to a wide range of consumer electronics. Mobile device typically is used to describe portable devices that can connect to the Internet. However, some also classify connected digital cameras and standard MP3 players as mobile devices as well. The category of mobile devices includes the following devices, as well as others:

#### **Smartphones**

Smartphones combine a mobile phone and a handheld computer into a single device. Smartphones allow users to access and store information (e.g. e-mail) and install programs (applications) while also being able to use a mobile phone in one device. For example, a smartphone could be a mobile phone with some PDA functions integrated into the device or vice versa.

#### **Tablet PCs**

A tablet computer is a computer that is intermediate in size between a laptop and a smartphone. Early tablet computers used either a keyboard or a stylus to input information, but these methods were subsequently displaced by touch screens.

Nearly all tablet computers can access the Internet using Wi-Fi, and many can use mobile phone networks like 2G, 3G, and 4G. Like smartphones, many tablets have sensors including a camera and a microphone. Other features of tablets include high definition, anti-glare displays, a Bluetooth radio (to connect to printers and other devices), flash memory, and cloud storage facilities to back up and synchronize data. Compared to laptop computers, tablets are lighter, more portable, have longer battery life, generate less heat, and don't need a mouse or keyboard to be connected. Typing is usually done on the touch screen with a "virtual" keyboard which appears on the screen. Most tablets allow the user to get notifications even when the tablet is powered off or on standby.

#### **Smartwatches**

A smartwatch is a wearable computer in the form of a wristwatch; modern smartwatches provide a local touchscreen interface for daily use, while an associated smartphone app provides for management and telemetry (such as long-term biomonitors). Some smartwatches function as portable media players, with FM radio and playback of digital audio and video files via a Bluetooth headset.

Some models, called 'watch phones' (or vice versa), have mobile cellular functionality like making calls.

The watch may communicate with external devices such as sensors, wireless headsets, or a heads-up display. Like other computers, a smartwatch may collect information from internal or external sensors and it may control, or retrieve data from, other instruments or computers. It may support wireless technologies such as Bluetooth, Wi-Fi, and GPS. For many purposes, a "watch computer" serves as a front end for a remote system such as a smartphone, communicating with the smartphone using various wireless technologies.

## 2. Read the text again and say whether these statements are true or false.

1. Modern mobile devices are multifunctional.
2. The term 'mobile device' refers only to smartphones.
3. Smartphones combine a mobile phone and a computer into a single device.
4. Tablet PCs have always been equipped with touchscreens.
5. Tablet PCs have smaller weight, longer battery life and generate less heat.
6. Smartwatches function as wearable computers.
7. A smartwatch is only used for long-term biomonitoring.
8. The watch can collect information from internal or external sensors.

## 3. Make a short summary of the text.

### LANGUAGE FOCUS

#### *THERE IS / THERE ARE*

#### *INDEFINITE PRONOUNS*

Consult grammar rule using the link:

<https://drive.google.com/file/d/1EbiBE0xmuL2p5mHpaENX3Q0LVVP3Hlms/view?usp=sharing>

## 1. Complete the sentences using the correct form of there is / there are, there was / there were, there will be.

1. \_\_\_\_ many tablet manufacturers like Google Pixel, Samsung Galaxy Tab, Nexus, and Apple iPad.
2. \_\_\_\_ 1.5 million computer science-related jobs in the US in the nearest future.
3. \_\_\_\_ anything wrong with your laptop?
4. \_\_\_\_ so many kinds of mobile devices available.
5. \_\_\_\_ usually a special mobile operating system built in tablets.
6. How many USB ports \_\_\_\_ on your tablet?
7. In 2018 \_\_\_\_ three major players in the mobile apps space including Google Play, Apple's AppStore and Amazon AppStore.

8. \_\_\_\_ a virtual or a physical keyboard on most smartphones?

**2. Complete the sentences with some, any or no.**

1. I downloaded a new update without \_\_\_\_ difficulty.
2. Everyone gets 5GB of free iCloud storage to get started and it's easy to upgrade at \_\_\_\_ time.
3. There is \_\_\_\_ compatibility with Samsung Health app and iOS.
4. At Apple you will develop your professional skills and work with \_\_\_\_ of the best minds in the business.
5. Can you give me \_\_\_\_ more information about this e-reader model?
6. With iCloud Photos, you can browse, search, and share all the photos and videos from \_\_\_\_ of your devices.
7. According to the producers, with Galaxy Note9's all-day battery you don't need \_\_\_\_ charger.
8. Could I have \_\_\_\_ more details about Samsung Galaxy Tab S4?
9. There is \_\_\_\_ more room for music on my phone.
10. There are \_\_\_\_ features that are Android and iOS compatible.

**3. Play a game «What's in your phone»? Ask questions to your partner using construction there is / there are. Choose at least three items from the list below. Change the roles.**

*Example: - Are there any unread emails in your phone? – No, there aren't any / Yes, there are some.*

Facebook app, 100+ contacts, 300+ pictures, videos, Instagram app, a protective case, a cracked screen, unread text messages, a ringtone as a song, more than 70% battery life, a selfie, a protected password, Android, iOS, headphones with you, Face ID, 8GB of RAM, VK app

**4. Complete the sentences with much / many / little / few / a little / a few.**

1. Generally, even one of the largest companies like Intel only has \_\_\_\_ computer architects.
2. This company is very small. There aren't \_\_\_\_ employees in it.
3. – How \_\_\_\_ does he work? – Too \_\_\_\_.
4. \_\_\_\_ years ago we knew very \_\_\_\_ about augmented reality.
5. How \_\_\_\_ hardware improvements have been made to the Galaxy Note9?
6. Very \_\_\_\_ of my friends have a digital camera, most of them use a built-in camera in their phones.
7. There are \_\_\_\_ layers of defense that protect your phone against malicious threats.

8. The design of this smartphone has made \_\_\_\_ impression on me. I expected more.
9. How \_\_\_\_ external storage is available with microSD card?
10. AR Emoji feature allows you to get \_\_\_\_ animated.

**5. Match the question with the appropriate answer.**

1. – What did you say?	a. – Nobody.
2. – Is everything clear to you?	b. – Please, do.
3. – Is there anybody waiting outside?	c. – Yes, I’m looking for a memory stick.
4. – Does anybody mind if I open the window?	d. – Nothing.
5. – Have you lost anything?	e. Any time. I’ll be in all day.
6. – Are you going anywhere today?	f. – Sorry, but I understand nothing.
7. – What time shall I come tomorrow?	g. – No, I’m too tired.

**6. Choose the right option.**

1. Is there *something* / *nothing* / *anything* interesting?
2. We haven’t demonstrated this to *anything* / *anybody* / *nobody* else.
3. They said *anything* / *nothing* / *something* new.
4. Have you heard *nothing* / *anything* / *nobody* about 5G capabilities?
5. There are so *little* / *many* / *much* times it’s easier to talk to your mobile phone than type.
6. The accuracy of voice recognition has improved dramatically over the last *little* / *a few* / *few* years.
7. I have absolutely *no* / *nothing* / *any* idea where to charge my phone.
8. If you can’t decide now which model to choose take *few* / *a little* / *little* time to think it over.
9. Too *many* / *little* / *much* heat can damage your phone.
10. I was looking for a charger *anywhere* / *everywhere* / *nowhere*, but I couldn’t find it *everywhere* / *nowhere* / *anywhere*.
11. There is *nothing* / *everything* / *something* wrong with the file. I can’t open it.
12. *Anybody* / *nobody* / *everybody* / has ever had any trouble with this machinery.

**SPEAKING**

1) Think about how you use your mobile phone. Add two more uses to the table. Then rank each use from 1 (the most frequent) to 7 (the least frequent).

Use	Ranking 1 (most frequent) – 7 least
-----	-------------------------------------

	<b>frequent)</b>
Taking photos	1.
Checking e-mail	2.
Using social media websites / apps	3.
Making calls to friends / family	4.
Looking up information on the internet	5.
	6.
	7.

When you have completed your table, compare your answers with a partner. Ask for more information.

2) Read through the lines and restore the dialogue by putting them in the correct order.

- Fine thanks. Listen, I haven't got long because I've got a maths class in a minute. I just wanted to see if you're still coming tonight.
-Hi Sandra, it's Cody.
-When is the exam?
-Hello!
-I'm not sure. I think my mum wants me to stay in tonight. I've got a Physics exam this week.
-How are you?
-OK, cool.
-Chat later.
-OK, well, let me speak to my mum and I'll message you later
-On Thursday.
-Well, what about if you come early and then my dad could give you a lift home at about ten. Most people are coming around seven anyway, and it would be cool if you came.
-Yeah, bye.

3) Now get into pairs and choose a situation to role-play. Imagine that you are talking on the phone. Act according to the instructions given.

<p><b>1</b></p> <p>You need to cancel a trip to the cinema because your pet has injured the leg and you'll have to take it to the vet.</p> <p>A – Answer the call and name yourself.</p> <p>B – Greet A in respond. Explain why you are calling.</p> <p>A – Say you regret and say you can meet another time.</p> <p>B – Say goodbye.</p> <p>A – Say goodbye in respond.</p>
--

**2**

Arrange with a good friend to go shopping on Saturday at the shopping centre.

A – Answer the call and name yourself.

B – Greet A in respond. Explain why you are calling.

A – Express your agreement.

B – Make arrangements for the meeting.

A – Agree, say goodbye.

B – Say goodbye in respond.

**3**

Phone your friend A to find out where they are. You've been waiting for them in a café for 20 minutes.

A – Answer the call.

B – Explain why you are calling.

A – Say you regret and explain what is up.

B – Say goodbye.

A – Say goodbye in respond.

Make use of the conversational formula below.

<b>Answer the phone</b>	<b>Greet in respond</b>	<b>Introduce yourself</b>
This is Cody. Hello, Cody speaking. Hello, Jennifer Smith speaking. Hello. Matt here	Hi Cody, how are you doing? Hi Cody, how are you getting on? Hi Jenifer, how is it going? Hi Jennifer, how are you? How are things?	Hey Mike, it's Ruby (calling).
<b>Explain why you are calling</b>	<b>Some more ideas</b>	<b>Inviting someone out</b>
Look here, I .... Listen, ..... I'm calling to .... Well, just a quick call to say... I'm calling about...	I didn't catch. - <i>I didn't hear.</i> Please hold. - <i>I have to leave the call for a moment, please stay on the phone.</i> Hang on. - <i>Wait for a moment.</i> Could you speak up?	Why don't we hang out at...? Do you want to hang out at my place? Let's go ..., shall we? Are you free tonight? Are you doing anything tonight? How about going .../ a game of...?
<b>Express regret</b>	<b>Say goodbye</b>	<b>End up the conversation</b>

Oh, I'm so sorry Sorry to hear that You must be very worried/ stressed Hmmm, that is a problem! That sounds terrible/ awful. No? Really?	Bye, talk to you later. Catch you later! See ya! ( <i>See you later</i> )	Sorry, I've got to hang up. ( <i>I've got to end the telephone call</i> ) I'll call you back later. Give me a buzz later. ( <i>Call me later</i> ). Talk again soon, OK?
<b>Respond to an invitation</b>		
Good idea, I'll be there That would be nice. I'd love to. Sure, that would be great! I'm afraid I can't.		

## WRITING

### Texting (writing text messages)

Study the list of some popular abbreviations and acronyms and their meanings. Acronyms are words that are formed mostly from the initial letters of a word or a phrase.

c - see	ttyl - Talk to you later
u - you	ymmd - You made my day
L8R - later	ctn - Cannot talk now
4 - for	sus - See you soon
b4 - before	hak - Hugs and kisses
2 - to/ two	gr8 - Great
brb - Be right back	idc - I don't care
tyl - Talk to you later	imu - I miss you
Rofl - Rolling on floor laughing.	j/k - Just kidding
lmk - Let me know	np - No problem
nvm - Never mind.	wycm - Will you call me?
hf - Have fun	tyvm - Thank you very much
idk - I don't know	tgif - Thanks God, its Friday
imho - In my humble opinion	sflr - Sorry, for late reply
nntr - No need to reply	omg - Oh my God

Now, what do you think the following abbreviations mean in these text messages? Work in pairs or on your own to work out the phrases or look them up on the Internet.

1. CU L8R
2. OMG UR so funny!
3. LOL
4. THX 4 that
5. CU 2nite
6. LMK
7. BRB
8. HRU
9. PCM
10. G2G

Do you use any similar abbreviations in your language?

Some people think that writing online is making young people's spelling and grammar worse. Do you agree? Why / not?

Now write a message for a situation in the role-play in Speaking. Then send your message to a partner and write a reply.

## LISTENING

### *Setting the context*

1. Do you know when the first portable commercial mobile phone went on sale?
2. How have mobile phones evolved since then?
3. Do you use any kind of wearable device? What features does a smartwatch or a fitness monitor provide?
4. How often do you use a navigation app on a smartphone?

### *Activating vocabulary*

**Match the English words with their Russian equivalents.**

1. hub	a) рентгеновский снимок
2. wearable	b) дополнительный
3. to enhance	c) выполнить
4. additional	d) центр деятельности
5. X-ray	e) всплывать
6. to accomplish	f) усилить
7. to pop up	g) носимый

**Match the words with their definitions.**



1. to superimpose	a) power or ability to do something
2. to revolve	b) to make something greater by adding to it
3. cellular	c) to place or lay one thing over another, typically so that both are still evident
4. to augment	d) to combine with another so that they become a whole
5. capability	e) denoting or relating to a mobile telephone system
6. to integrate	f) to move around in a circle on a central axis

Before proceeding to CHECKING YOUR UNDERSTANDING section, please follow the link to watch the video: <https://www.youtube.com/watch?v=8MEP8uQ3ckU>

*Check your understanding:*

Match the words from column A with the words from column B to form phrases:

1. augmented	a) life
2. communication	b) viewer
3. GPS	c) directions
4. electronic	d) reality
5. heart	e) satellites
6. long battery	f) environment
7. media	g) hub
8. virtual	h) access
9. turn-by-turn	i) rate
10. touchscreen	j) paper

Circle the best answer to these questions.

- Tablets usually run \_\_\_\_\_.
  - Windows
  - Linux
  - iOS
  - Android
- The types of input associated with tablets include \_\_\_\_\_.
  - a keyboard

- a touchscreen
  - a mouse
  - a stylus
3. A tablet is from \_\_\_\_.
- 3,5 inches to 6 inches diagonal device
  - 7 inches diagonal device
  - 14 inches diagonal device
4. A smartphone is \_\_\_\_.
- a wearable device
  - a global positioning system device
  - a communication hub
5. Which device has an exceptionally long battery life?
- A smartphone
  - A tablet
  - An e-reader
  - A smartwatch
6. E-readers use \_\_\_\_.
- a color LCD screen
  - a very light screen
  - a black and white screen
7. The battery in e-readers is used when \_\_\_\_.
- you read information on the screen
  - you change pages
  - you update information
8. A smartwatch \_\_\_\_.
- enhances the ability to watch videos
  - is designed to perform extremely well in direct light
  - integrates with a mobile phone
9. With virtual reality devices \_\_\_\_.
- we combine the real world and the virtual world
  - we completely remove the real world
  - we are able to see everything that's outside of the display you put on
10. A GPS navigator gives you \_\_\_\_.
- turn-by-turn directions

- a wide range of different applications
- information about your heart rate

**Answer the following questions based on the video.**

1. What is the advantage of electronic paper technology?
2. What interesting characteristic do e-readers have?
3. How does augmented reality work?
4. What examples of augmented reality application could you give from the video?
5. How does a GPS navigator receive signals?
6. What are the two ways of updating a GPS device?

## UNIT 4

### OPERATING SYSTEMS

#### START-UP

##### 1. Answer the questions.

1. What popular operating systems do you know? Which one is installed in your devices?
2. Do you think one and the same operating system can be used for computing, programming and gaming?

#### VOCABULARY

##### 1. Match the words to their definitions.

- |                            |  |
|----------------------------|--|
| 1) array                   | a) an improved or updated version of something   |
| 2) password                | b) a computer program that controls a device   |
| 3) default                 | c) the central, most important part of something   |
| 4) upgrade                 | d) a sequence of characters that must be entered in order to gain access to electronically locked or protected computer or security systems, files, etc.   |
| 5) driver                  | e) a computer or program that supplies data or resources to other machines on a network  |
| 6) kernel                  | f) a preset choice, setting, etc. for automatic use as by a program when no other is specified by a user   |
| 7) server                  | g) a technique through which multiple operating systems can be kept within the boot sequence on the same computer  |
| 8) geek                    | h) a group of two or more logically related elements, identified by a single name and usually stored in consecutive storage locations in main memory   |
| 9) dual booting            | i) an emulation of a computer system   |
| 10) virtual machine        | j) a means of interacting with a computer program where the user (or client) issues commands to the program in the form of successive lines of text (command lines)  |
| 11) command line interface | k) a form of user interface that allows users to interact with electronic devices through graphical icons and visual indicators such as secondary notation, instead of text-based user interfaces, typed command labels or text navigation |

- 12) graphical user interface      l) a person regarded as being especially enthusiastic, knowledgeable, and skillful in the use of computers

**2. Match the synonyms given below.**

- |                 |                 |
|-----------------|-----------------|
| 1) generic      | a) to deliver   |
| 2) to upgrade   | b) structure    |
| 3) to terminate | c) common       |
| 4) architecture | d) edition      |
| 5) version      | e) to finish    |
| 6) varied       | f) designed for |
| 7) intended for | g) different    |
| 8) to master    | h) to modernize |
| 9) to ship      | i) to learn     |

**3. Complete the table with the necessary derivatives. Pay attention to the meaning of the words.**

Verb	Noun	Adjective
perform		
	compression	
		terminal
vary		
	preference	
		productive
administer		
	revolution	
		inclusive
populate		

**READING**

**1. Read the text and answer the questions.**

1. What is an operating system?
2. What lower level tasks can it perform?
3. What is the kernel responsible for?
4. Give examples of non-Windows operating systems.
5. What are the two major user interfaces?
6. What is Ubuntu?

## An Operating System

An operating system is a generic term for the multitasking software layer that lets you perform a wide array of 'lower level tasks' with your computer. By low-level tasks it is meant: the ability to sign in with a username and password; sign out the system and switch users; format storage devices and set default levels of file compression; install and upgrade device drivers for new hardware; install and launch applications such as word processors, games, etc.; set file permissions and hidden files; terminate misbehaving applications.

A computer would be fairly useless without an OS, so today almost all computers come with an OS pre-installed. Before 1960, every computer model would normally have its own OS custom programmed for the specific architecture of the machine's components. Now it is common for an OS to run on many different hardware configurations.

At the heart of an OS is the kernel, which is the lowest level, or core, of the operating system. The kernel is responsible for all the most basic tasks of an OS such as controlling the file systems and device drivers. The only lower-level software than the kernel would be the BIOS, which isn't really a part of the operating system.

The most popular OS today is Microsoft Windows, which has about 85% of the market share for PCs and about 30% of the market share for servers. But there are different types of Windows OSs as well. Each Windows OS is optimized for different users, hardware configurations, and tasks.

There are many more operating systems out there besides the various versions of Windows, and each one is optimized to perform some tasks better than others. Free BSD, Solaris, Linux and Mac OS X are some good examples of non-Windows operating systems.

Geeks often install and run more than one OS on a single computer. This is possible with dual-booting or by using a virtual machine. Why? The reasons for this are varied and may include preferring one OS for programming, and another OS for music production, gaming, or accounting work.

An OS must have at least one kind of user interface. Today there are two major kinds of user interfaces in use, the command line interface (CLI) and the graphical user interface (GUI). Right now you are most likely using a GUI interface, but your system probably also contains a command line interface as well.

Typically speaking, GUIs are intended for general use and CLIs are intended for use by computer engineers and system administrators. Although some engineers only use GUIs and some diehard geeks still use a CLI even to type an email or a letter.

Examples of popular operating systems with GUI interfaces include Windows and Mac OS X. Unix systems have two popular GUIs as well, known as KDE and Gnome, which run on top of X-Windows. All three of the above mentioned operating systems also have built-in CLI interfaces as well for power users and software engineers. The CLI in Windows is known as MS-DOS. The CLI in Mac

OS X is known as the Terminal. There are many CLIs for Unix and Linux operating systems, but the most popular one is called Bash.

In recent years, more and more features are being included in the basic GUI OS install, including notepads, sound recorders, and even web browsers and games. This is another example of the concept of 'convergence' which we like to mention.

A great example of an up and coming OS is Ubuntu. Ubuntu is a Linux operating system which is totally free, and ships with nearly every application you will ever need already installed. Even a professional quality office suite is included by default. What's more, thousands of free, ready-to-use applications can be downloaded and installed with a few clicks of the mouse. This is a revolutionary feature in an OS and can save lots of time, not to mention hundreds or even thousands of dollars on a single PC. Not surprisingly, Ubuntu's OS market share is growing very quickly around the world.

As an IT professional, you will probably have to learn and master several, if not all, popular operating systems. If you think this sort of thing is fun and interesting, then you have definitely chosen the right career.

## **2. Read the text again and say whether these statements are true or false.**

1. A computer can work without an operating system.
2. An operating system can run only on one hardware configuration.
3. The kernel is responsible for all the most basic tasks of an OS.
4. Microsoft Windows is the dominant OS on the market.
5. It is impossible to install and run more than one OS on a single computer.
6. Graphical user interface is intended for general use and command line interface is for system administrators.
7. A Linux OS Ubuntu is becoming popular because it is totally free.

## **3. Make a short summary of the text.**

### **LANGUAGE FOCUS**

#### ***DEGREES OF COMPARISON***

**Consult grammar rule using the link:**

**<https://drive.google.com/file/d/1NEINZoeUzG1JVHb2Z8NL5XS4CdFEJKa1/view?usp=sharing>**

#### **1. Make comparisons as in the example.**

***Example: A laptop, a tablet, a smartphone (portable)***

*A laptop is portable. A tablet is more portable.*

*A smartphone is the most portable.*

***A smartphone, a laptop, a desktop (portable)***

*A smartphone is portable. A laptop is less portable.*

*A desktop is the least portable.*

1. Windows 10, Mac OS X, Linux (secure)
2. Nick's program, Phillip's program, Pavel's program (good)
3. Google's Android, Apple's iOS, Windows 10 Mobile (popular)
4. A laptop screen, a tablet screen, a smartphone screen (small)
5. Windows, MacOS, Linux (familiar for ordinary users).
6. Linux user base, Mac OS X user base, Windows user base (large)
7. A laptop, a desktop, a supercomputer (powerful)
8. Windows 10, Mac OS X, Linux (vulnerable)

## **2. Choose the best option.**

1. Recent advances in computer processing allows manufacturers to process information *the fastest / more fast / faster*.
2. Apple park is one of *the most large / the largest / larger* construction projects in the world.
3. Every Apple product is designed to make everyone's life *best / gooder / better*.
4. People use technology to solve some of *the biggest / bigger / the most big* problems facing society.
5. A new display on iPhone XR is *the more advanced / the most advanced / the advancedest* in the industry.
6. Intelligent A12 Bionis is *smarter / more smart / the smartest* chip in a smartpone, with the next generation Neural Engine.
7. Altair Engineering makes computer-aided engineering software used to create *more stronger / more strong / stronger, more better / better / the goodest, more innovative / innovativer / most innovative* products.
8. *The smaller / more small / the smallest* unit of information is a single bit.
9. Google creates tools that help keep everyone *safer / more safe / more safer* online.
10. *The goodest / the best / the better* part about technology is seeing what the world does with it.

## **3. Complete the sentences with the appropriate form of the irregular adjective.**

1. – Are your programming skills improving? – Yes, they're getting \_\_\_\_ (good).
2. The damage to your laptop isn't so bad. It could have been much \_\_\_\_ (bad).
3. It is \_\_\_\_ (bad) smartphone I've ever had.
4. Machine learning could also be used to predict crash risks and \_\_\_\_ (good) understand driver's reactions behind the wheel.
5. These days much \_\_\_\_ (many) people are using smartphones.
6. Windows Phone OS is considered to be \_\_\_\_ (bad) than Android.
7. I've got \_\_\_\_ (far) information on this issue.



8. Apple's more than 100.000 employees are dedicated to making \_\_\_\_ (good) products on earth, and to leaving the world \_\_\_\_ (good) than we found it.
9. Windows 8 is \_\_\_\_ (bad) version of Microsoft Windows.
10. This month Misha's spent \_\_\_\_ (little) time on playing computer games than last month.

**4. Complete the sentences with the appropriate form of the adjective from the box.**

Great, rich, expensive, small, intelligent, good, useful, late

1. An iMac is much \_\_\_\_ than a PC.
2. The availability of data and information is a lot \_\_\_\_ now than it has ever been.
3. What is \_\_\_\_ version of Windows?
4. The recent innovations in cloud technology aim to make Microsoft platforms far \_\_\_\_.
5. The Apple ecosystem offers \_\_\_\_ integration between Mac OS computers and iOS-running mobile devices that no other company can match.
6. Apple computers market share is much \_\_\_\_ than the PC market share.
7. Bill Gates is the founder of Microsoft and one of \_\_\_\_ men in history.
8. The more you know about the business of IT, the \_\_\_\_ IT professional you will become.

**5. Complete the text by changing the form of the words in brackets.**

Linux is an open source OS whereas Windows is commercial. However, Windows remains the winner in terms of popularity. It is \_\_\_\_ (popular) OS for home and office computers, while Linux is \_\_\_\_ (available) on corporate and scientific servers. Though Linux is not \_\_\_\_ (widely-used) OS in the world, it will run \_\_\_\_ (fast) than Windows latest editions. Nevertheless, Windows has \_\_\_\_ (large) collection of videogame software. Linux distributions are \_\_\_\_ (customizable) than Windows, because Windows has very few customization options available. As Windows has a \_\_\_\_ (large) user base than Linux, it is \_\_\_\_ (vulnerable) to viruses and other malware. Thus, Windows has the reputation of being \_\_\_\_ (secure) than Linux simply because it's \_\_\_\_ (widely-used) desktop OS and \_\_\_\_ (targeted).

**6. Make your own sentences using the comparatives and the superlatives.**

1. Microsoft / large software business / in the world.
2. Windows / secure / Linux.
3. Windows 10 PCs provide / fast processors / and quiet Windows hard drives / the previous PCs.
4. Linux / used OS / with the users accounting for 2%.

5. Windows 10 / compatible / with all kinds of software / MacOS X.
6. MacOS X / vulnerable to malware / Windows 10.
7. Windows / wide game selection / of all operating systems.
8. For developers and programmers Linux / good choice.
9. Linux / available for free / Windows and MacOS X.
10. Linux / secure OS / of all.

## SPEAKING

Windows is one of the easiest desktop operating systems to use. Two of its primary design characteristics are user friendliness and simplicity of basic system tasks.

1) Watch an introductory video which is a kind of a tutorial to how to navigate Windows.

[https://youtu.be/\\_jvp61NwGT8](https://youtu.be/_jvp61NwGT8)

2) You will have to explain the basics of how to navigate the interface, using the words and some question as prompts below.

a) Study the vocabulary first

desktop - рабочий стол	double click - двойной клик (щелчек)
screen - экран	icon - значок, иконка
desktop background - фон рабочего стола	to drag - тащить
wallpaper - обои	to release - отпустить
taskbar - панель задач	settings - настройки
shortcut - ярлык (клавиша быстрого доступа)	to switch between - переключиться между
start button - кнопка «Пуск»	maximize - увеличить до предела
File Explorer - файловый менеджер	

b) Answer the questions with a partner looking at the pictures:

- How do you call the screen you see after you have started up the computer?
- What can you see on the screen? Or what does the screen include?
- Where is the taskbar?
- What can you find on the Taskbar?
- What do you click the Start Button for?
- What is the function of File Explorer on the Taskbar?
- How do you open a program, a file or a folder?
- How do you close a window?
- What happens each time you click something?
- What do you do to move windows?
- How do you switch between two windows if you have them open at the same time?

- What can you do with a window using the three buttons on the top right of the window?

- What do you do to return the window to its original size after you have maximized/ minimized the window?

1.



2.

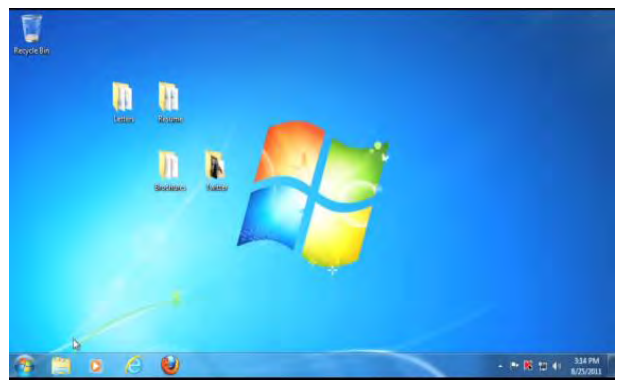

3.

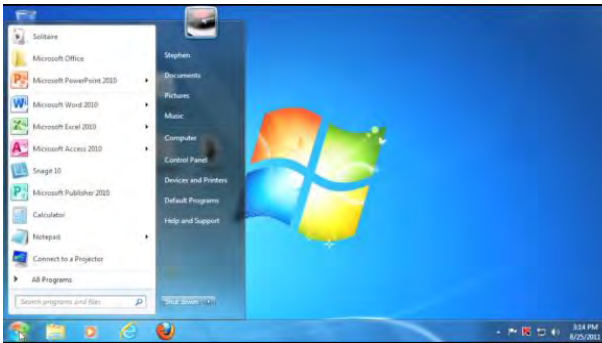

4.

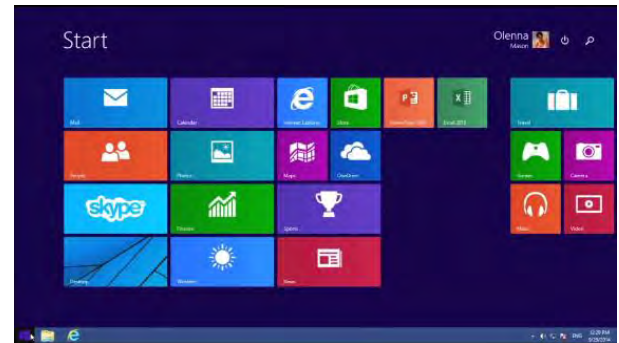

5.

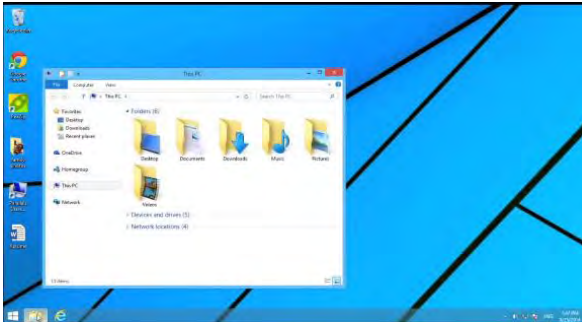

6.

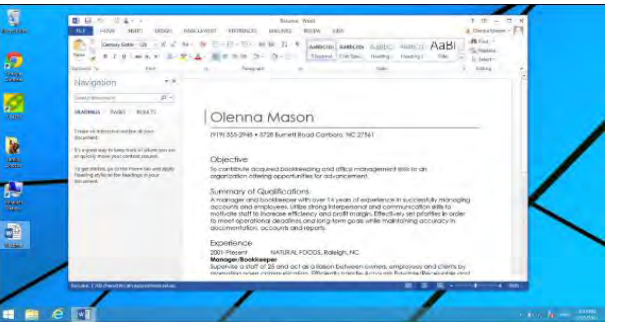

7.

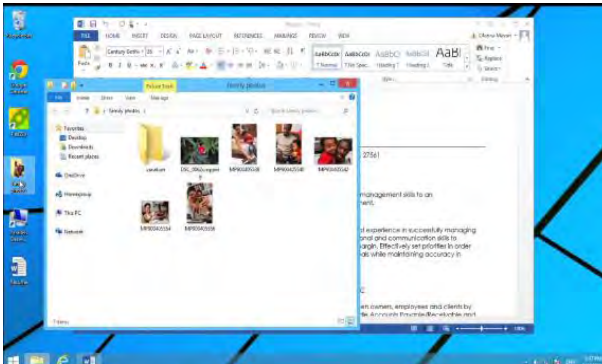

8.

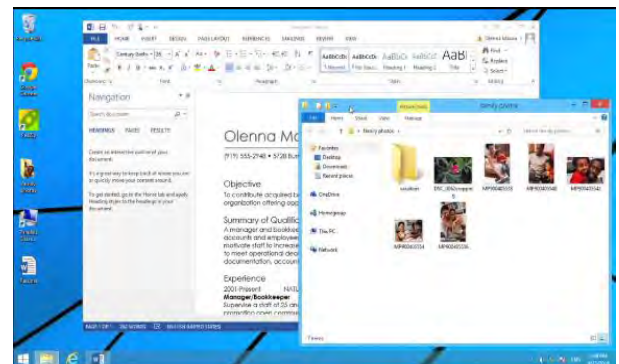

9.

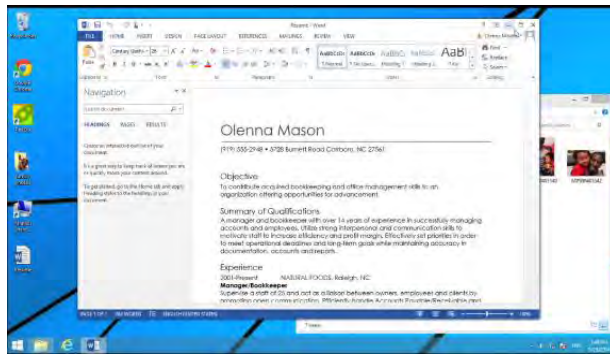

10.

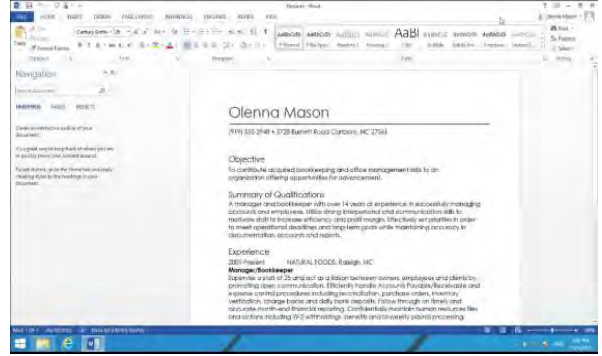

3) Watch the video once again to check your ideas.

4) Optional task:

Watch the video with the sound off and try to voice it yourself using the answers to the questions above.

You can now watch the video again, this time with the sound on, and compare.

## WRITING

Write a short tutorial with the basic information of how to navigate Windows using the questions you have made in Speaking as a guideline.

## LISTENING

### SETTING THE CONTEXT

1. Which operating system do you use? Are you happy with it? Can you single out the main advantage of your OS over the other ones?
2. Have you ever heard about Linus Torvalds? What is he famous for?
3. Read this funny meme to see the difference between a tech enthusiast and a programmer:

### *Programmers:*

I work in IT, which is the reason our house has:

- mechanical locks
- mechanical windows
- routers using OpenWRT
- no smart home crap
- no Alexa/Google Assistant/...
- no internet connected thermostats

### ***Tech Enthusiasts:***

**Tech Enthusiasts:** Everything in my house is wired to the Internet of Things! I control it all from my smartphone! My smart-house is bluetooth enabled and I can give it voice commands via alexa! I love the future!

### ***ACTIVATING VOCABULARY***

**Match the English words (phrases) with their Russian equivalents.**

1. deciding factor	a) осознавать неприкосновенность частной жизни
2. to spot bugs and security flaws	b) многосторонний, многоцелевой, универсальный
3. to lock down a computer	c) быть безопасным по своей сути
4. versatile	d) замечать ошибки и уязвимости
5. to be inherently secure	e) заблокировать компьютер
6. repository	f) коммерческая компания
7. to be privacy conscious	g) решающий, определяющий фактор
8. for-profit company	h) хранилище, репозиторий

### ***FOCUS ON PHRASAL VERBS***

<b><i>Phrasal Verb</i></b>	<b><i>Definition</i></b>	<b><i>Example sentence</i></b>
<b><i>to figure out</i></b>	to understand, find the answer	He's trying to figure out how to earn enough money to go on the trip to Spain.
<b><i>to get into sth</i></b>	to become interested in an activity or subject, or start being involved in an activity	I'll get into later.
<b><i>to mess up</i></b>	to spoil smth or do smth badly	You can mess things up potentially.
<b><i>point sth out</i></b>	to tell someone about some information, often because you believe they do not know it or have forgotten it	I guess I should point out as a disclaimer...



**Before proceeding to CHECKING YOUR UNDERSTANDING section, please follow the link to watch the video:**

<https://www.youtube.com/watch?v=O3n6bArDEbc>

***CHECK YOUR UNDERSTANDING***

**Match the words from column A with the words from column B to form phrases:**

1. tech	a) by default
2. upgrade to	b) list of advantages
3. tech-savvy	c) up to date
4. to run	d) enthusiasts
5. keeping things	e) users
6. totally exhaustive	f) a new version

**Circle the best answer to these questions.**

The most obvious advantage of Linux over Microsoft is \_\_\_\_

- the cost of ownership;
- the use of CLI;
- the use of Linux would not result in a malicious infection on the computer.

If you want to upgrade to a new version of Windows \_\_\_\_

- you need to pay;
- you may donate some money;
- you need to buy a new computer.

Linux is pretty much inarguably more secure than Windows because \_\_\_\_

- it's open-source and it's viewable by a lot of different people;
- if a virus does infect Linux software it can really do way more damage;
- Linux users are tech-savvy so they know how to lock down their computer.

A repository looks like \_\_\_\_

- a big database or storage center for all sorts of different software;
- an official website of the software;
- a department store.

If you want to use an operating system not for a desktop environment, say, build a computer to use as a firewall, you will

- definitely use Windows on your firewall system;
- install a server version of Ubuntu;

- install a special distro called Fedora.

What does *distro* stand for?

- distribution;
- district;
- distinction.

Which operating system is more customizable?

- Linux
- Windows

Linux is definitely a lot better for people who \_\_\_\_

- are very privacy conscious;
- can barely boot up Windows;
- strongly dislike command-line interface.

Telemetry is \_\_

- the automatic recording and transmission of data from remote sources to an IT system for monitoring and analysis;
- a network security device that monitors incoming and outgoing network traffic and decides whether to allow or block specific traffic based on a defined set of security rules;
- none of the above.

**Try to name all the reasons Linux is better than Windows and choose one to talk about.**

## UNIT 5

### DATABASE MANAGEMENT SYSTEM (DBMS)

#### START-UP

##### 1. Answer the questions.

1. Do you often deal with large amount of data?
2. How do you organize them?

#### VOCABULARY

##### 1. Match the words to their definitions.

- |                  |  |
|------------------|--|
| 1) database      | a) the process of restoring a database to a previously defined state, typically recover from error   |
| 2) concurrency   | b) a process of retrieving inaccessible, lost, damaged or formatted data from secondary storage, removable media or files, when the data stored in them cannot be accessed in a normal way |
| 3) integrity     | c) very strong or sturdily built   |
| 4) backup        | d) devices that store application and user information   |
| 5) recovery      | e) the ability of the database to support multiple users and processes simultaneously  |
| 6) storage media | f) a copy of a file or other item of data made in case the original is lost or damaged   |
| 7) robust        | g) state of being a united whole, unity  |
| 8) overhead      | h) a large collection of data in a computer, organized so that it can be expanded, updated, and retrieved rapidly for various uses   |
| 9) rollback      | i) regular and essential expenses  |

##### 2. Match the synonyms given below.

- |              |                            |
|--------------|----------------------------|
| 1) iteration | a) place                   |
| 2) to reside | b) to change               |
| 3) to ensure | c) to process              |
| 4) location  | d) repetition              |
| 5) to handle | e) to guarantee            |
| 6) to modify | f) numerous                |
| 7) multiple  | g) to examine, to check    |
| 8) to audit  | h) to be present, to exist |



**3. Complete the table with the necessary derivatives. Pay attention to the meaning of the words.**

Verb	Noun	Adjective
		iterative
	integrity	
locate		
	dependence	
define		
		secure
	addition	
differ		
		foundational
systematize		

**READING**

**1. Read the text and answer the questions.**

1. What is a database management system (DBMS)?
2. What does this system manage?
3. What administration tasks are supported by the DBMS?
4. The DBMS can offer both logical and physical data independence, can't it?
5. What are the advantages of a DBMS?

**Database Management System**

A database management system (DBMS) is system software for creating and managing databases. The DBMS provides users and programmers with a systematic way to create, retrieve, update and manage data.

A DBMS makes it possible for end users to create, read, update and delete data in a database. The DBMS essentially serves as an interface between the database and end users or application programs, ensuring that data is consistently organized and remains easily accessible.

The DBMS manages three important things: the data, the database engine that allows data to be accessed, locked and modified – and the database schema, which defines the database's logical structure. These three foundational elements help provide concurrency, security, data integrity and uniform administration procedures. Typical database administration tasks supported by the DBMS include change management, performance monitoring, backup and recovery. Many database management systems are also responsible for automated rollbacks, restarts and recovery as well as the logging and auditing of activity.

The DBMS is perhaps most useful for providing a centralized view of data that can be accessed by multiple users, from multiple locations, in a controlled

manner. A DBMS can limit what data the end user sees, as well as how that end user can view the data, providing many views of a single database schema. End users and software programs are free from having to understand where the data is physically located or on what type of storage media it resides because the DBMS handles all requests.

The DBMS can offer both logical and physical data independence. That means it can protect users and applications from needing to know where data is stored or having to be concerned about changes to the physical structure of data (storage and hardware). As long as programs use the application programming interface (API) for the database that is provided by the DBMS, developers won't have to modify programs just because changes have been made to the database. With relational DBMSs (RDBMSs), this API is SQL, a standard programming language for defining, protecting and accessing data in a RDBMS.

#### Advantages of a DBMS

Using a DBMS to store and manage data comes with advantages, but also overhead. One of the biggest advantages of using a DBMS is that it lets end users and application programmers access and use the same data while managing data integrity. Data is better protected and maintained when it can be shared using a DBMS instead of creating new iterations of the same data stored in new files for every new application. The DBMS provides a central store of data that can be accessed by multiple users in a controlled manner.

Central storage and management of data within the DBMS provides:

- Data abstraction and independence
- Data security
- A locking mechanism for concurrent access
- An efficient handler to balance the needs of multiple applications using the same data
- The ability to swiftly recover from crashes and errors, including restartability and recoverability
- Robust data integrity capabilities
- Logging and auditing of activity
- Simple access using a standard application programming interface (API)
- Uniform administration procedures for data

Of course, a DBMS must perform additional work to provide these advantages, thereby bringing with it the overhead. A DBMS will use more memory and CPU than a simple file storage system. And, of course, different types of DBMSes will require different types and levels of system resources.

<https://searchsqlserver.techtarget.com/definition/database-management-system>

## **2. Read the text again and say whether these statements are true or false.**

1. The DBMS provides users and programmers with a random way to create, retrieve, update and manage data.

2. The DBMS essentially serves as an interface between the database and end users or application programs.
3. A DBMS cannot limit what data the end user sees, as well as how that end user can view the data.
4. Developers will have to modify programs just because changes have been made to the database.
5. The DBMS provides a central store of data that can be accessed by multiple users in a controlled manner.
6. A DBMS does not bring with it any overheads.

### 3. Make a short summary of the text.

## GRAMMAR

### *SIMPLE TENSES*

Consult grammar rule using the link:

[https://drive.google.com/file/d/1fm\\_3aEknBMBhtcDJzvMpxKAiX4YgtJmj/viiew?usp=sharing](https://drive.google.com/file/d/1fm_3aEknBMBhtcDJzvMpxKAiX4YgtJmj/viiew?usp=sharing)

### 1. Fill in the gaps with a verb from the box in the correct Present Simple form.

develop, require, support, see, help, deal, manage, have

1. A multiuser database \_\_\_\_ multiple users at the same time.
2. Database designers \_\_\_\_ the database structure.
3. Database systems \_\_\_\_ sophisticated hardware and software and highly skilled personnel.
4. The DBMS \_\_\_\_ to create an environment in which end users \_\_\_\_ better access to more and better-managed data.
5. Database administrators \_\_\_\_ the DBMS.
6. The user \_\_\_\_ the relational database as a collection of tables.
7. Linear Algebra \_\_\_\_ with linear equations, matrices, vectors, etc.

### 2. Complete the text with the affirmative or negative Present Simple form of the verb in brackets.

Data in its raw form \_\_\_\_ (to have) no value. Data \_\_\_\_ (to need) to be processed in order to be of valuable. A flat file database \_\_\_\_ (to store) data in a text file and, unlike a relational database, \_\_\_\_ (not / to contain) multiple tables and relations. Relational databases \_\_\_\_ (to use) Structured Query Language (SQL) that \_\_\_\_ (to provide) an easy programming interface for database interaction. Some common examples of relational databases \_\_\_\_ (to include) MySQL, Microsoft SQL Server, Oracle, etc. Flat file databases \_\_\_\_ (not / to

represent) complex relationships between entities. Some real-life examples of flat databases \_\_\_\_ (to be) contact lists in a mobile phone.

### **3. Write questions about the things underlined in the sentences.**

1. Big data reflects the changing world we live in.
2. Typically, a database structure stores data in a tabular format.
3. Security rules determine which users can access the database.
4. The interface allows the user to interact with the data.
5. Corporations invest considerable amounts of time, effort, and money to ensure that corporate data are used properly.
6. The users employ SQL to create table structures.
7. Database systems require sophisticated hardware and software and highly skilled personnel.
8. The user sees the relational database as a collection of tables.

### **4. Rewrite the sentences, changing the Present Simple Active forms into Passive forms.**

1. Organizations use large amounts of data.
2. You often see the standard acronym DBMS instead of the full name.
3. System analysts and programmers design and implement the application programs.
4. An upside-down tree represents the basic logical structure of the hierarchical model.
5. A DBMS provides security rules to determine access rights of users.
6. Database systems hold crucial company data.
7. Companies don't generally use the network database model today.

### **5. Complete the sentences with the affirmative or negative Present Simple or Future Simple form of the verb in brackets.**

1. While the DBMS \_\_\_\_ (not / guarantee) data quality, it \_\_\_\_ (provide) a framework to facilitate data quality initiatives.
2. If you \_\_\_\_ (update) your database system you \_\_\_\_ (to maximize) its efficiency.
3. Database administrators \_\_\_\_ (not / produce) a useful database environment if a database design \_\_\_\_ (be) poor.
4. Next week if you \_\_\_\_ (not / have) the authorization to edit the data you \_\_\_\_ (have) to get an appropriate access level.
5. As soon as we check the database user permissions, we \_\_\_\_ (let) you know.
6. Next time in case of power failure special utilities within a database system \_\_\_\_ (provide) data recovery.
7. – Can you wait for me? It \_\_\_\_ (not / be) very long.

8. I'm sure Pavel \_\_\_\_ (get) the job. He \_\_\_\_ (have) a lot of experience.

**6. Write the Past Simple of the following verbs:**

drive	cut	retrieve	study
be	do	leave	have
store	begin	try	run
write	represent	make	create
take	give	hold	know
stop	go	understand	develop

**7. Find the past forms of 20 irregular verbs in the puzzle. Read across, down and diagonally.**

H	W	D	W	R	O	T	E	E
A	F	E	I	X	T	H	S	D
D	O	O	N	D	T	O	L	D
C	U	T	R	T	R	U	O	X
M	N	Z	X	G	O	G	S	K
E	D	C	N	C	O	H	A	S
A	X	A	L	E	F	T	I	O
N	R	M	I	X	U	Z	D	L
T	Z	E	S	P	O	K	E	D

**8. Complete the text with the Past Simple Active form of the verbs in brackets.**

Bill Gates \_\_\_\_ (to be born) in 1955 in Seattle, Washington. He \_\_\_\_ (to grow up) in an upper middle-class family. The Gates family atmosphere \_\_\_\_ (to be) warm and close, and all three children \_\_\_\_ (to be encouraged) to be competitive and strive for excellence. When Bill \_\_\_\_ (to turn) 13, his parents \_\_\_\_ (to enroll) him at Seattle's exclusive preparatory Lakeside School. At Lakeside School Gates \_\_\_\_ (to meet) Paul Allen. The pair \_\_\_\_ (to become) fast friends because of their common enthusiasm for computers. They both \_\_\_\_ (to spend) much time together working on programs. In 1970, at the age of 15, Bill Gates and Paul Allen \_\_\_\_ (to go) into business together, developing "Traf-o-Data", a computer program that \_\_\_\_ (to monitor) traffic patterns in Seattle. In 1975, Bill Gates and Paul Allen \_\_\_\_ (to form) Microsoft.

**9. Complete the text with the Past Simple and Present Simple (Active or Passive) and the verbs from the box.**

attract, introduce, publish, consider, understand, publish, outline, follow
---

The relational model \_\_\_\_\_ in 1970 by Edgar F. Codd, a British computer scientist with IBM. He \_\_\_\_\_ “A Relational Model of Data for Large Shared Data Banks.” At the time, the renowned paper \_\_\_\_\_ little interest, and few scientists \_\_\_\_\_ how Codd’s groundbreaking work would define the basic rules for relational data storage. Codd later \_\_\_\_\_ another paper that \_\_\_\_\_ the 12 rules that all databases must follow to be qualified as relational. Many modern database systems (not) \_\_\_\_\_ all 12 rules, but these systems \_\_\_\_\_ relational because they conform to at least \_\_\_\_\_ two \_\_\_\_\_ of \_\_\_\_\_ the \_\_\_\_\_ 12 \_\_\_\_\_ rules.

## 10. Read the text and ask six different types of questions on it.

Last year our company considered replacing spreadsheets with a database to help our business grow. We needed to keep track of the increased amount of customer data. Thus, the customer relationship management (CRM) database was developed by database designers. The CRM system provided a central place for storing all our information and sharing it with other teams. The records were created and the history was tracked of all our interactions with the customers, including phone calls, emails, meetings, presentations and so on. The CRM database made our service more efficient, cost-effective and reliable.

### SPEAKING

You are about to study information about two database applications.

1) Before that, look through the notions below.

1. **backup and recovery** - резервное копирование и восстановление данных
2. **customized** - оптимизированный под требования пользователя
3. **inventory** - учетная информация, инвентарь, перечень
4. **data migration** - перенос данных
5. **data replication** - тиражирование данных
6. **database conversion** - конвертирование данных (преобразование, перенос и проверка согласованности и непротиворечивости данных, оставшихся от прежней программы и необходимых для работы в новой системе.
7. **SQL (Structured Query Language)** - основной интерфейс работы с реляционными БД, используется для добавления, обновления и удаления строк данных, извлечения наборов данных для обработки транзакций и аналитических приложений, а также для управления всеми аспектами работы базы данных.
8. **NOSQL- Not Only SQL** - нереляционные БД, для хранения больших объемов неструктурированной информации
9. **virtualization** – использование виртуальных образов

2) Now study characteristics of one of the applications, A or B.

**Student A**



**Active Query Builder by Active Database Software**

<b>Who Uses This Software?</b>	Business application developers who work on a software dealing with SQL databases.
<b>Target Customer Size (Users)</b>	1 - 49
<b>Starting Price</b>	\$199.00/one-time/user
<b>Free Trial</b>	Yes
<b>Free Version</b>	No
<b>Features</b>	Backup and Recovery Data Migration Data Replication Data Security Database Conversion Mobile Access NOSQL Performance Analysis Relational Virtualization

**Student B**



**Kohezion by Kohezion**

<b>Who Uses This Software?</b>	Kohezion is a business software. It allows end-users to create their own customized applications: client tracker, task tracker, meetings, inventory, calendar or any data you need to manage.
<b>Target Customer Size (Users)</b>	1 - 1000+
<b>Starting Price</b>	\$4.20/month/user
<b>Free Trial</b>	Yes
<b>Free Version</b>	Yes
<b>Features</b>	Backup and Recovery Data Migration Data Replication

	Data Security Database Conversion Mobile Access NOSQL Performance Analysis Relational Virtualization
--	--

3) Get into pairs (A-A, B-B) to make questions about the other application and figure out the target user, the target customer size, the starting price, the features, and if there is a free trial and a free version. Use prompts to make up questions.

1. Who/for?
2. What/can/do?
3. How many users/designed/for?
4. How and how much/should/pay?
5. Can/try/for free?
6. Is/free version?
7. Can/backup/ data?
8. Does/provide/data migration?
9. Can/replicate/data?
10. Are/secured?
11. Does/allow/data conversion?
12. Can/access/ your mobile phone?

4) Get into pairs, A – B.

Take it in turns to ask your partner questions you have made.

## WRITING

Write a comparative analysis of these applications. Don't forget to use the question prompts from **Speaking** and your partner's answers.

Here are some prompts to help you with the task.

- To be (more) likely to do smth ... (Application A is more likely to...)
- To be similar to... (Application A is/ isn't similar to ...)
- Unlike ... (Unlike App A, App B is ...)
- whereas/ while (App A is ..., while/ whereas App B is ...)
- On the one hand, on the other hand (On the one hand, App A is ..., on the other hand it is...)
- In comparison with ... (In comparison with App A, App B is ...)
- In contrast to ... (In contrast to App A, App B is ...)
- There is/ isn't a huge difference between ...



## LISTENING

### *SETTING THE CONTEXT*

1. What is a database? What kind of information can it manage?
2. Have you ever asked a store employee to check their system for a special item? Then you've seen a database in action. Try to name at least 5 more situations when you deal with databases.
3. Imagine that you run an online toy store. What software would you use to keep track of your customer orders?
4. Comment on the following quote: «Even the most complicated tasks can be made simple and user-friendly once you understand how databases work».

### *ACTIVATING VOCABULARY*

**Match the English words (phrases) with their Russian equivalents.**

1. to keep track of smth	a) излишний, избыточный
2. to record	b) назначать, определять, устанавливать
3. redundant	c) следить за ходом чего-либо
4. shipment	d) сущность
5. to assign	e) записывать, фиксировать
6. purchase	f) запрос
7. entity	g) отправка (товаров); перевозка; поставка
8. query	h) приобретение, покупка

**Before proceeding to CHECKING YOUR UNDERSTANDING section, please follow the link to watch the**

**video:** <https://www.youtube.com/watch?v=wR0jg0eQsZA>

**CHECK YOUR UNDERSTANDING**

**Match the words from column A with the words from column B to form phrases:**

1. database	a) popular
2. redundant	b) situation
3. shipping	c) values
4. to be enormously	d) architecture
5. messy	e) information
6. to take	f) from scratch
7. bite-sized	g) side
8. contradicting	h) address
9. to start	i) a look
10. flip	j) tables

**Circle the best answer to these questions.**

1. Imagine that you run an online store. If you record the information about your customers in a spreadsheet you may \_\_\_\_
  - Get some contradicting values for your customer's details;
  - Easily calculate your profit from sales;
  - Organize your orders by creating a relational database.
2. What may happen if you don't keep track of your customer orders according to the video?
  - shipments could get sent to the wrong place;
  - customers might get mixed up;
  - the wrong products could get sent to the wrong people;
  - you may have to pay a penalty for underpayment of estimated tax.
3. It is advisable to keep the information about your online store in some bite-sized tables. These tables might list out \_\_\_\_
  - all your Customers;
  - all your Products;
  - all your Orders;
  - all your profit.
4. A database consists of \_\_\_\_
  - several tables connected to one another;
  - several cells;

- rows and columns.
5. After a customer checks out, we record all the contact info and
    - assign them a customer ID;
    - send them an invoice;
    - send them a mailshot.
  
  6. Database management systems typically don't give you the best options for \_\_\_\_\_
    - visualizing the connections between different tables;
    - optimizing the database performance;
    - improving data sharing.
  
  7. Trying to make sense of a large database when you're in the database can be \_\_\_\_\_
    - very taxing;
    - relaxing;
    - perplexing.
  
  8. In an ERD (Entity Relationship Diagram) \_\_\_\_\_
    - each table translates into an entity and column categories are listed as attributes in their respective entity;
    - each table translates into an attribute and column categories are listed as entities;
    - none of the above.

## UNIT 6

### GAME DEVELOPMENT

#### START-UP

##### 1. Answer the questions.

1. Do you play computer games? If yes, name your favourite ones.
2. Do you know any games created by Belarusian developers?

#### VOCABULARY

##### 1. Match the words to their definitions.

- |                     |   |
|---------------------|---|
| 1) game development | a) to write a program or set of instructions that tells a computer to do something  |
| 2) content          | b) a software development environment designed for people to build video games  |
| 3) to script        | c) a program or framework that lets you to play sound files   |
| 4) sound engine     | d) a degree of lightness, darkness, strength, etc. of a colour  |
| 5) surround sound   | e) computer software that provides an approximate simulation of certain physical systems, such as rigid body dynamics (including collision detection), soft body dynamics, and fluid dynamics, of use in the domains of computer graphics, video games and film |
| 6) vertex shading   | f) a platform for developing software applications  |
| 7) hue              | g) a graphics processing function, which manipulates vertex data values on an X (length), Y (height) and Z (depth) 3D plane through mathematical operations on an object  |
| 8) physics engine   | h) a system of sound recording and reproduction that uses three or more independent recording channels and loudspeakers in order to give the impression that the listener is surrounded by the sound sources  |
| 9) framework        | i) everything that is contained within something  |



build, test and release. While you create a game, it is important to think about the game mechanics, rewards, player engagement and level design.

A game developer could be a programmer, a sound designer, an artist, a designer or many other roles available in the industry.

Game development can be undertaken by a large game development studio or by a single individual. It can be as small or large as you like. As long as it lets the player interact with content and is able to manipulate the game's elements, you can call it a 'game'.

A video programmer, also known as a game software engineer or a video game programmer, develops video games intended for entertainment or educational purposes. While there are usually several layers to this position, a video programmer is primarily charged with the task of writing the code that runs the game and directs probable outcomes of play. They are also involved in scripting supplemental components, such as development tools and computer assisted software to establish the game's platform and interface capability, as well as to develop its architecture. Typically, a team of programmers works together in the production of a single video game. However, many video programmers specialize in a specific area of development.

For example, a video programmer may be dedicated to working exclusively on the sound engine of a video game, including writing script to project 3D positional sound, what is more commonly known as surround sound. The challenge to this role is developing code to drive specific sounds and variations in sound to reflect the attributes of certain characters in the game and the actions they perform, as well as to indicate the level of play or goal accomplishment.

In contrast, a video programmer may be assigned to concentrate on developing the graphics for a game. Depending on the device the game is designed for, the programmer may be asked to develop two dimensional (2D) or three dimensional (3D) graphics, with the former usually being reserved for handheld games, PDAs, and cell phones. In the case of the latter, the video programmer may specialize in creating code to execute advanced 3D graphic effects known as pixel and vertex shading, which provides sharp contrast and color hues to produce a realistic 3D appearance.

Some video programmers specialize in animation, which involves developing a predictable set of physics laws that may or may not resemble those found in the natural world. Also known as dynamical simulation, this aspect of game development is attributed to the creation of a physics engine, which defines how certain characters and objects will move in a given environment and how they will behave when that environment is altered due to an event taking place in the game.

To resolve problems that game frameworks had, tools like libGDX and OpenGL were developed. They helped game development to be a lot faster and easier, providing lots of pre-made functions and features. However, it was still hard to enter the industry or understand a framework for someone coming from a non-programmer background, a common case in the game development scene.

Then game engines like Construct, Game Maker, Unity and Unreal were developed. Generally, an engine has everything that a framework had, but with a more friendly approach by using a graphic user interface (GUI) and helping with the graphic development of the game.

In some cases, like Game Maker and Construct, the amount of pre-made functions are so big that people with no previous programming skills could build a game from scratch, really expanding the scene and making game development accessible for almost anyone.

<https://www.wisegeek.com/what-is-a-video-programmer.htm>

<https://guide.freecodecamp.org/game-development/>

## 2. Read the text again and say whether these statements are true or false.

1. A game developer can be only a programmer.
2. Game development is the art of creating games and describes the design, development and release of a game.
3. Video games are intended only for entertainment.
4. A video programmer is a versatile specialist.
5. A physics engine defines how certain characters and objects will behave in a given environment.
6. Game frameworks provide lots of pre-made functions and features.
7. People with no previous programming skills could build a game from scratch using game engines.

## 3. Make a short summary of the text.

### **LANGUAGE FOCUS**

#### **PROGRESSIVE TENSE FORMS**

Consult grammar rule using the link:

[https://drive.google.com/file/d/1oz8C\\_7hQd2M5jXoRMFPyo4lrxFg0fOnV/view?usp=sharing](https://drive.google.com/file/d/1oz8C_7hQd2M5jXoRMFPyo4lrxFg0fOnV/view?usp=sharing)

### 1. Choose the correct form of Present Progressive (Active or Passive):

1. The popularity of the video game development field *is being boomed / are booming / is booming* these days.
2. Amazing progress *is making / is being made / are being made* in the industry of game development at present.
3. I *is learning / am being learnt / am learning* specific skills through technical tutorial on the topic AR Photography with Unity Toolkit.
4. Nowadays real-time 3D projects *are building / are being built / is being built* with the help of Unity.

5. Our game designers *are being dealt / are being dealing / are dealing* with a new game concept this week.
6. Game studios *are always being looked / are always looking / are always being looking* for great programming talent.
7. Some adjustments *is making / are making / are being made* to the game mechanics right now.
8. In game design teams you *is collaborating / are being collaborating / collaborating* all day with other team members.
9. Our studio *are being used / is being used / is using* C# for coding in Unity.
10. I *am focusing / are focusing / am being focused* on learning Java because it's a very dynamic language with lots of applications.

**2. Change the verb into the correct form of Present Progressive (Active or Passive):**

1. Denis \_\_\_\_ (to study) to be a game programmer.
2. They \_\_\_\_ (to use) Unity to simulate new building designs in interactive 3D space.
3. \_\_\_\_ Julia (to start) a new game development course tomorrow?
4. Unity 3D game engine tools \_\_\_\_ (to learn) by a great number of individuals these days.
5. The designers \_\_\_\_ (to brainstorm) the initial vision for a game right now.
6. \_\_\_\_ you (to have) a better understanding of the Unity 3D editor now?
7. Godot engine has a community that \_\_\_\_ constantly (to fix) bugs and (to develop) new features.
8. \_\_\_\_ Nick (to look) for a game developer position?
9. Steam games \_\_\_\_ constantly (to improve) with the gamers' feedback.
10. Nowadays Artificial Intelligence \_\_\_\_ (to enter) a new growth phase.

**3. Choose the right tense form (Present, Past or Future Progressive).**

1. Nowadays the popularity of game development *was only increasing / will only be increasing / is only increasing*.
2. All day tomorrow we *are being tested / will be testing / were tested* the game to make sure it runs smoothly.
3. When I *am planning / will be planning / was planning* a game I joined a channel of game designers.
4. This evening at 7p.m. Andrew *was playing / will be playing / is being played* PUBG.
5. The battle royal genre *is expanding / were expanding / was being expanded* with new games releasing on a monthly basis.
6. I *will be watching / is watching / is being watched* the latest video uploads on the Construct YouTube channel tonight.
7. DOTA 2 *was currently being played / will currently be playing / is currently being played* by most of my friends.



8. A new mobile app *is developing / was being developed / was developing* by our team the whole last month.

#### 4. Write questions about the things underlined in the sentences.

1. Cloud computing is completely changing our society.
2. Ann was working hard the whole last week to complete the project.
3. Philip will be learning the Unity 3D game engine tools at tomorrow's seminar.
4. The selection of games for Linux is being risen these days.
5. About 7000 games for MacOS are currently being supported by Steam platform.
6. Many people are starting to replace regular laptops with smaller, more mobile devices.
7. Our team will be discussing the game prototypes from 2 till 5 p.m. tomorrow.
8. The world's largest car manufacturers are exploring innovative ways to speed up and enhance the design process.
9. DVD disks are constantly being pushed back by more convenient online game stores.
10. Alexander was trying to sell his laptop the whole last month.

#### 5. Fill in the gaps with a verb from the box in the correct Past Progressive form (Active or Passive) or Future Progressive.

play, discuss, fix, practice, talk, improve, chat, work, test, focus
--

1. I remember, when designing one of my mobile games, I \_\_\_\_\_ on a way to allow players to switch easily between weapons.
2. Tonight at 8 p.m. as Denis \_\_\_\_\_ the bugs, Pavel \_\_\_\_\_ the graphics.
3. Every time a new major element was added, the game \_\_\_\_\_.
4. Tomorrow at this time we \_\_\_\_\_ on better game interaction with a player.
5. Yesterday while Max \_\_\_\_\_ Dota 2, Nick \_\_\_\_\_ to his friend.
6. All day yesterday the issues relating to Game Design Patterns \_\_\_\_\_.
7. I \_\_\_\_\_ building a game through a tutorial with Unity all evening yesterday.
8. Tomorrow at this time, the designers \_\_\_\_\_ about the game mechanics and the flow of the game.

#### 6. Correct the mistakes.

1. If you're on a team, you are being worked with loads of other people who have different backgrounds.
2. Our game developers will be determined the initial game requirements when you come.
3. Yesterday from 9 to 11 a.m. I am reading the fantastic The Art of Game Design by Jess Schell.

4. The world of automotive design is being changed rapidly these days.
5. AAA (Triple-A) game commonly denotes that a game are publishing by a large, established publisher.
6. All day tomorrow our team was being developed the game interface.
7. When the customer came the app was still testing.
8. Microsoft has research labs that is working on a number of breakthrough technologies to improve cybersecurity.

**7. Complete the sentences with the correct Progressive tense form (Active or Passive) of the verbs in brackets.**

1. Next week at this time we \_\_\_\_ (to work) hard to get this project done.
2. Dota \_\_\_\_ constantly (to evolve), but it's never too late to join.
3. Many things about game development \_\_\_\_ (to become) extremely easy with today's game engines.
4. Tomorrow from 3 to 5 p.m. they \_\_\_\_ (to adjust) the game physics.
5. Fiber optic cable and the infrastructure for 5G \_\_\_\_ currently (to deploy) by the company across the country.
6. Microsoft security engineers \_\_\_\_ constantly (to adjust) their security approach.
7. Yesterday while Pavel \_\_\_\_ (to visualize) data and locations, Alexander \_\_\_\_ (to build) various levels.
8. I \_\_\_\_ (to plan) to use an already-made game engine as it provides a wide range of functionalities.
9. 3D modeling of characters and objects \_\_\_\_ (to create) the whole last month.
10. Tomorrow as David \_\_\_\_ (to fix) the problem with the code, we \_\_\_\_ (to make) adjustments to the game mechanics.
11. Now they \_\_\_\_ (to partner) with the leading providers of online education. Currently optical drives \_\_\_\_ (to drop) from pre-made computers and laptops by hardware manufacturers.

**SPEAKING**

1) You have reviews of two computer games (A and B). The reviews are from both critics and from users. Read about one of the games. Before that, learn the words below.

**1. noble** - знатный, дворянин

**2. plague [pleig]** - чума, мор

**3. revenge** - месть

**4. distract** - отвлечь, сбить с толку

**8. glitch** - накладка, «глюк»

**9. hibernation** - гибернация, спящий режим

**10. corporate board** - коллегиальный орган

**11. terraforming** - изменение условий на планете на более подходящие для

5. **potion** - зелье, снадобье  
6. **slingshot** - рогатка  
7. **on the spot** - в тот же момент,  
тут же

человека

12. **conspiracy** - (зд.) тайный сговор  
13. **threaten** - угрожать  
14. **faction** - (зд.) группировка

## Student A

### *A Plague Tale: Innocence*

#### Critic Review

##### General Information

**Release:** May 14, 2019

**Available on:** PC, PlayStation 4, Xbox One PC

**Developer:** Asobo Studio (France)

**Genre:** an action-adventure horror stealth game

**Mode:** single-player

*A Plague Tale: Innocence* is a solid single-player game. It is a combination of action and emotional storytelling.

Players take the role of **Amicia De Rune**, the daughter of a noble man in 14th century France at the time of the plague that is spread by rats. She has a five-year-old brother, **Hugo**, who has a supernatural thing in his blood that makes him a target of the Inquisition. After the Inquisition soldiers attack their home, Amicia and Hugo must make their way through the country. During their journey, they meet other children who help them in their search for answers and revenge.

Amicia and Hugo have to hide from Inquisition soldiers and distract enemies with various skills and alchemical potions. Rats can also be dangerous if they get too close. Amicia arms herself with a slingshot, which can sling rocks at soldiers and can be upgraded. Hugo also gains some skills to fight off the rats and even use them to get past soldiers. Hiding is always preferable to fighting, but sometimes the children have no choice. Amicia can also collect resources in her environments, things that she can use to make alchemical potions on the spot. There are some emotional situations throughout the game that can leave a player in tears. The voice acting is particularly good.

The game has no noticeable bugs or glitches. The graphics are also much better than one might expect: for example, you can see the textures of the clothing distinctly and hair flows in a very natural way. There's nothing to complain about. It is a successful combination of horror, action, survival, combat and story.

#### User Reviews

##### Johnnybg1981

May 24, 2019

At the beginning the game looks very interesting and promising, but at one point it becomes too repetitive.

##### lls27

May 25, 2019

rats rats rats rats rats ratsrats rats ratsrats rats ratsrats rats ratsrats rats ratsrats rats ratsrats rats ratsrats rats rats

## Sioux123

May 22, 2019

It is a lot of dialogues. You don't manage to read. Especially, when it is necessary to move. The text quickly disappears and is badly readable.

### **Student B**

#### **The Outer Worlds**

#### Critic Review

#### **General Information**

**Release:** Oct 25, 2019

**Available on:** PC, PlayStation 4, Xbox One

**Developer:** Obsidian Entertainment (USA)

**Genre:** RPG

**Mode:** single-player

**Description:** **The Outer Worlds** is a new single-player player-driven story sci-fi RPG. According to the plot of the game, you wake up after a long hibernation on a spaceship on its way to Halcyon — a human colony on the far edge of the galaxy. Halcyon is a colony owned and operated by a corporate board. They control everything... except for the alien monsters left behind when the terraforming of the colony's two planets didn't exactly go according to plan. As the main character, you will find yourself involved in a deep conspiracy that threatens to destroy the entire human settlement. During your journey through the furthest colony, you will meet a lot of characters who will want to join your crew. Armed with unique abilities, these companions all have their own missions, motivations, and ideals. It's up to you to help them achieve their goals, or turn them to your own ends. A unique character created by you will be able to influence the course of this story, exploring the depths of space and meeting numerous factions that are fighting for power on Halcyon ... Find your ship, build your crew, and explore the settlements, space stations, and other intriguing locations throughout Halcyon.

#### User reviews

#### Cygnusmoon

Nov 3, 2019

Before buying, everything seemed so attractive, it sounded like nothing could fail. Well, lots of things did. Let's begin with the STORY: The idea and the theme feel so badly carried out. All the missions feel so simple, with a great lack of originality in the quest designing.

It's the low levels of greatness in what happens in the missions. There's no action beyond combat in the game. Nothing blows up, no cinematics, nothing. It seems like the game forgets about the existence of feelings in the players. It will never make you feel sad, happy, furious, nostalgic.

The COMBAT is quite poor, there's little variety of weapons, and the kind of enemies you face is also very repetitive and limited.

#### Esthete

Nov 29, 2019

RPG must have an interesting plot, characters, variability and an interesting gameplay. The Outer Worlds not about that. Plus lags.

**devilchao0**

Oct 26, 2019

Very, very average. The story is not very engaging. I wouldn't call this game bad. It feels very dated and like something that would have come out early. Wait for a sale if you really want to try it.

2) Get into pairs **A-A, B-B**. Make questions you will ask a partner from the opposite group about their game. Use the prompts below to help you.

Ask about

1. the name of the game. (What/ the name.....?);
2. the company which produces it. (What company...?);
3. the platform on which it is played. (What platform...?);
4. the plot and the characters. (Who/ characters? What/ do? When/ happen?);
5. the tasks players have to perform. (What tasks/ have to do? Who helps...? What weapon/ have?);
6. the bad points and good points. (What/ good/bad..?).

Answer these questions about your game and take notes for later use when you will have to answer similar questions from the opposite group partner.

3) Get into pairs A-B, interview each other about the games using the questions you have made. Don't forget to take notes. You will make use of them to complete the writing task.

What similarities and differences have you found?

## WRITING

Write a passage comparing the two games.

Show the similarities and differences of the games. Use the prompts and the template below, the prompts from Unit 5 (Writing), and your own notes on the games:

<b>Comparison</b>	<b>Addition</b>	<b>Generalising</b>	<b>Summarizing</b>
Equally	Additionally	On the whole	Finally
In the same way	Furthermore	In general	Last of all
In a similar way	Along with	To some extent	To sum up
In comparison with	Besides	In many ways	All in all
	In addition		
	Moreover		

### Template:

Topic: **A Plague Tale: Innocence** and *The Outer Worlds*

1. Introduction (*Here is a comparative analysis of two video games...*)
2. Main body
  - Paragraph 1: similarities (*The two games have much in common... : the year of release, platforms, mode, using stealth, etc.*)
  - Paragraph 2: differences (*One can't but mention certain differences ... :the developer, genre, characters, weapon, tasks, etc.*)
- 3 Conclusion

## LISTENING

### SETTING THE CONTEXT

1. All people have played video games at least once, but not all of them are gamers. There may be some gamers among your friends or relatives.
2. Think of 3 games that you really enjoy playing. What do you like most about them?
3. Can you tell the difference between a gamer and an e-sports athlete? What is the latter like?

### ACTIVATING VOCABULARY

**Match the English words (phrases) with their Russian equivalents.**

1. fundamentals	a) ритм, периодичность
2. to master	b) предвещающий; зловещий
3. successive	c) говорить, сообщать
4. rhythm	d) вырабатывать стратегию, разрабатывать подробный план
5. thoughtful	e) изменение; внесение изменений
6. ominous	f) овладевать, усваивать; достичь вершин мастерства (в чём-л.)
7. to communicate	g) последующий; следующий один за другим
8. workflow	h) мгновенный; немедленный, незамедлительный
9. alteration	i) задумчивый
10. to strategize	j) основы, основные положения
11. instantaneous	k) последовательность выполняемых действий; технологический процесс

**Before proceeding to CHECKING YOUR UNDERSTANDING section, please follow the link to watch the**

**video:** <https://www.youtube.com/watch?v=rHEJZXvFc5I>

**CHECK YOUR UNDERSTANDING**

**Match the words from column A with the words from column B to form phrases:**

1. critical	a) effect
2. linear	b) of the iceberg
3. game's	c) of an eye
4. the tip	d) speed
5. to be grounded	e) eye
6. gameplay	f) in reality
7. in the blink	g) aesthetic

**Circle the best answer to these questions.**

The 12 Principles of Animation were first set out \_\_\_\_

- in a book called *The Illusion of Life* by some ex-Disney animators;
- by the author of this video on his blog;
- in a book *Character Animation Crash Course!* by Eric Goldberg.

The 12 Principles of Animation represent \_\_\_\_

- a collection of techniques established by the animators of those earliest Disney feature films;
- a new set of rules for game animators;
- none of the above.

Animation is a time-based \_\_\_\_

- craft;
- draught;
- draft.

Timing is \_\_\_\_

- about measuring change over time;
- the speed or tempo at which an action takes place;
- all above.

What action is not listed in the video as having fast Timing?

- the bounce of a rubber ball;

- the sharp kick of a fired gun;
- the quick blinks of a character's eyelids.

What action isn't said to have slow timing?

- the action of standing up from a seated position;
- the leisurely descent of a paraglider;
- the ominous opening of a Dark Souls door.

According to the video you can use timing to communicate all sorts of stuff such as \_\_\_\_\_

- size, scale and weight;
- character's feelings and emotions;
- all above.

Let's consider the action of standing up from a seated position again. What can a game animator communicate if they program the action to take much longer than usual?

- the character seems excited;
- the character may be startled;
- the character feels tired or depressed.

What is the animator's standard unit for measuring time?

- a frame;
- a second;
- a minute.

What is Spacing in games animation?

- Spacing is about how far something moves or changes from one frame to the next;
- Spacing means increasing the number of frames at the beginning and end of a movement;
- none of the above.



## UNIT 7

### ALGORITHMS. PROGRAMMING LANGUAGES

#### START-UP

##### 1. Answer the questions.

1. How often do you use algorithms in everyday life? Do you know any types of them?
2. Do you know any programming languages?

#### VOCABULARY

##### 1. Match the words to their definitions.

- |                  |  |
|------------------|--|
| 1) loop          | a) a group of people with special technical skills, who work together on a task or project   |
| 2) flowchart     | b) advanced and complex  |
| 3) to execute    | c) a series of organized, planned actions for a particular purpose   |
| 4) ubiquitous    | d) the science or study of analyzing and deciphering codes, ciphers  |
| 5) sophisticated | e) a diagram, often using geometric symbols, showing steps in a sequence of operations, as in manufacturing or in a computer program |
| 6) cryptography  | f) having the ability to be everywhere at once; omnipresent  |
| 7) campaign      | g) to carry out, to perform  |
| 8) crew          | h) a series of instructions in a program, performed repeatedly until some specified condition is satisfied                           |

##### 2. Match the synonyms given below.

- |                  |                   |
|------------------|-------------------|
| 1) feature       | a) omnipresent    |
| 2) selection     | b) insufficient   |
| 3) ubiquitous    | c) main           |
| 4) sophisticated | d) choice         |
| 5) essential     | e) useful         |
| 6) to allocate   | f) timetable      |
| 7) scarce        | g) important      |
| 8) beneficial    | h) to assign      |
| 9) core          | i) advanced       |
| 10) schedule     | j) characteristic |

**3. Complete the table with the necessary derivatives. Pay attention to the meaning of the words.**

Verb	Noun	Adjective
	execution	
		representative
select		
		repetitive
	publicity	
digitize		
	analysis	
		manipulative
reside		
	privacy	

## READING

**1. Read the text and answer the questions.**

1. What is an algorithm?
2. How are algorithms classified?
3. What are the main characteristics of algorithms?
4. Where are algorithms used?

### Algorithms

An algorithm can be defined as "A sequence of steps to be carried out for a required output from a certain given input". There are 3 main features of algorithm from its definition:

1. The essential aim of an algorithm is to get a specific output.
2. An algorithm involves several continuous steps.
3. The output comes after the algorithm finished the whole process.

So basically, all algorithms perform logically while following the steps to get an output for a given input.

#### Types of Algorithm

Algorithms can be classified into 3 types based on their structures:

1. **Sequence:** this type of algorithm is characterized with a series of steps, and each step will be executed one after another.
2. **Branching:** this type of algorithm is represented by the "if-then" problems. If a condition is true, the output will be A, if the condition is false, the output will be B. This algorithm type is also known as "selection type".
3. **Loop:** for this type, the process might be repeatedly executed under a certain condition. It is represented by "while" and "for" problems. But make sure

the process will end after a number of loops under the condition. This algorithm type is also known as "repetition type".

Algorithms can be used in many areas, and they are often represented in flowchart form for visual understanding. In other words, a flowchart is a diagram that represents an algorithm, showing the steps in various boxes and displays the process by connecting the boxes together.

Practical applications of algorithms are ubiquitous and include the following examples:

The Human Genome Project has made great progress toward the goals of identifying all the 100,000 genes in human DNA, determining the sequences of the 3 billion chemical base pairs that make up human DNA, storing this information in databases, and developing tools for data analysis. Each of these steps requires sophisticated algorithms. The savings are in time, both human and machine, and in money, as more information can be extracted from laboratory techniques.

The Internet enables people all around the world to quickly access and retrieve large amounts of information. With the aid of clever algorithms, sites on the Internet are able to manage and manipulate this large volume of data. Examples of problems that make essential use of algorithms include finding good routes on which the data will be, and using a search engine to quickly find pages on which particular information resides.

Electronic commerce enables goods and services to be negotiated and exchanged electronically, and it depends on the privacy of personal information such as credit card numbers, passwords, and bank statements. The core technologies used in electronic commerce include public-key cryptography and digital signatures which are based on numerical algorithms and number theory.

Manufacturing and other commercial enterprises often need to allocate scarce resources in the most beneficial way. An oil company may wish to know where to place its wells in order to maximize its expected profit. A political candidate may want to determine where to spend money buying campaign advertising in order to maximize the chances of winning an election. An airline may wish to assign crews to flights in the least expensive way possible, making sure that each flight is covered and that government regulations regarding crew scheduling are met. An Internet service provider may wish to determine where to place additional resources in order to serve its customers more effectively. These are just a few examples where algorithms are most useful.

<https://www.edrawsoft.com/algorithm-definition.html>

<https://mitpress.mit.edu/books/introduction-algorithms-third-edition>

## **2. Read the text again and say whether these statements are true or false.**

1. All algorithms perform logically while following the steps to get an output for a given input.
2. Branching is an example of "repetition type" algorithm.
3. Practical applications of algorithms are limited.

4. Sophisticated algorithms do not save time and human and machine resources.
5. Electronic commerce is based on the technologies of public-key cryptography.
6. The use of algorithms is more beneficial and widespread in industry than in public service.

### 3. Make a short summary of the text.

## LANGUAGE FOCUS

### *PERFECT TENSES*

Consult grammar rule using the link:

<https://drive.google.com/file/d/1LY98yLAXRjUoAMr6eVuZncEphaetIzF/view?usp=sharing>

**1. Use the words given to make sentences. Use the Present Perfect and proper time words (*since, already, yet, for, just, over, recently*).**

1. I / start / learning Python.
2. Denis / create / his first Unity 3D project.
3. They / be / interested in web development / several years.
4. Dota 2 / be / part of my life / 2015.
5. JavaScript / gain / a lot of popularity / the last few years.
6. Google / give / more than \$250 million toward education / 2005.
7. Many organizations / incorporate / AI into key processes and services.
8. I / not develop / the algorithm to test the code.

**2. Fill in the gaps with a verb from the box in the correct Present Perfect form (Active or Passive).**

**be, develop, build, recommend, convert, introduce, use, share**

1. Being a Java developer, it \_\_\_\_ easy for me to get started with Kotlin.
2. I \_\_\_\_ to learn Python because it's a good language for beginners.
3. – \_\_\_\_ you ever \_\_\_\_ Android Studio? – Sure, I \_\_\_\_ already \_\_\_\_ my first app using Android Studio tools.
4. Kotlin is a cross-platform programming language, so we \_\_\_\_ Kotlin code with all of the target platforms.
5. Pinterest \_\_\_\_ successfully \_\_\_\_ Kotlin in their application, used by 150M people every month.
6. KeepSafe App Lock \_\_\_\_ to 100% Kotlin leading to 30% decrease in source line count.
7. JavaScript is a popular language for web development. Popular sites like eBay, PayPal and Uber \_\_\_\_ using JavaScript.

### 3. Ask questions to the partner using Present Perfect.

1. Ever / download / a video from YouTube?
2. Already / set up / an account in Facebook?
3. Ever / write / code in C++?
4. What app / install / on your smartphone recently?
5. Buy / any Android device over the last few years?
6. Play / Counter-Strike recently?
7. Ever / run / Linux?
8. Already / use / Google Drive to store files?
9. What / buy / online lately?
10. Ever / participate / in an e-sports tournament?
11. Install / any app from Google Play Store over the last few months?
12. What online game / play lately?
13. Ever / develop / a website?
14. What language / use / recently to write code?

### 4. Change the verb into the correct form of Past Perfect or Past Simple (Active or Passive):

1. I \_\_\_\_ (look) through a lot of guides before I \_\_\_\_ (find) the most useful one.
2. Ann \_\_\_\_ (apply) to many companies before she \_\_\_\_ (invite) for an interview.
3. When Misha \_\_\_\_ (decide) to sell his laptop he \_\_\_\_ already (have) it for 5 years.
4. By 2012 Google \_\_\_\_ (scan) more than 15M books.
5. Before Victor \_\_\_\_ (learn) to program in Java he \_\_\_\_ (learn) Python.
6. After I \_\_\_\_ (complete) a tutorial I \_\_\_\_ (write) simple code in C#.
7. Julia \_\_\_\_ (try) a free trial with Unity Learn before she \_\_\_\_ (buy) a full version.
8. The game \_\_\_\_ (adjust) before we \_\_\_\_ (release) it.

### 5. Choose the best option.

1. Valve \_\_\_\_ many classic games like Counter-Strike, Dota 2 that will be played for years to come.
  - a) have been created
  - b) has created
  - c) had created
2. Java Script \_\_\_\_ one of the most dominant languages over the last few years for front-end work.
  - a) had become
  - b) have become
  - c) has become

3. New content \_\_\_\_\_ on the website by this time tomorrow.
- a) has been uploaded
  - b) will have been uploaded
  - c) have uploaded
4. They \_\_\_\_\_ a lot of research before they finally solved the problem.
- a) had conducted
  - b) has been conducted
  - c) will have conducted
5. I \_\_\_\_\_ in Czech Republic for a year before I moved to Greece.
- a) has been
  - b) had been
  - c) have been
6. Our developers \_\_\_\_\_ new features to the game mechanics by next month.
- a) had been brought
  - b) will have brought
  - c) have brought
7. Recently, I \_\_\_\_\_ on a variety of developer tools at Facebook.
- a) has been worked
  - b) will have worked
  - c) have worked
8. The project \_\_\_\_\_ by the deadline last week.
- a) have been completed
  - b) had completed
  - c) had been completed
9. Next year I \_\_\_\_\_ for the company for three years.
- a) have been worked
  - b) will have worked
  - c) will have been worked
10. Android \_\_\_\_\_ the choice of phones available around the world.
- a) will have expanded
  - b) had been expanded
  - c) has expanded
11. By next September Mark \_\_\_\_\_ C++ for a year.
- a) will have been studied
  - b) will have studied
  - c) have been studied

12. Kotlin \_\_\_\_ successfully by major companies.
- a) has been adopted
  - b) had adopted
  - c) will have adopted

### 6. Correct the mistakes.

1. Some of the popular games like Counter-Strike, World of Warcraft will have made with C++.
2. Recently, big tech companies has been chosen Python as their primary back-end programming language.
3. Last week I downloaded a Java Tutorial for Complete Beginners. I has never used Java before.
4. By next October, Pavel has learnt Python for a year.
5. Alexander have applied to many companies before he got the job.
6. For a student who have never been programmed before, using a statically typed language seems unnatural.
7. After Julia has been followed a style guide for Python code she started to program in Python more productively.
8. By this time tomorrow we have wrote a simple program to control a simulated robot.

### SPEAKING

1) Work in groups, A-B-C-D. Each of you has information about some programming languages.

#### Student A

Study this information about some programming languages. Be ready to use this information in the discussion with Student B and Student C

<b>Java</b>	Developed by Sun Microsystems in the mid-1990s, Java is widely used for developing interactive applications for the Internet.
<b>Ada</b>	Named after Countess Ada Lovelace (one of the first programmers); it is a superset of Pascal. Ada is a structured language developed and used by the US Department of Defense. It is now used not only for military applications, but also in air traffic systems (UK), on high-speed rail system (TGV, France), the metro suburban trains in Paris, London, Hong Kong and New York City.
<b>Logo</b>	Logo is an easy-to-use language that is primarily used to teach children how to program.
<b>LISP</b>	Stands for LISt Processor; LISP is designed to process nonnumeric data - that is, symbols such as characters or words. It

	is used to develop applications in the field of artificial intelligence.
--	--

### Student B

Study this information about some programming languages. Be ready to use this information in the discussion with Student A and Student C.

<b>Prolog</b>	Stands for PROgramming LOGic; Prolog is used to develop applications in the field of artificial intelligence. It is a popular tool for natural-language programming
<b>Perl</b>	Its name comes from Practical Report and Extraction Language. It first appeared in 1987 as a Unix-based tool for producing reports but is now widely used for creating interactive webpages.
<b>HTML</b>	Stands for HyperText Markup Language; HTML is a page description language used to prepare a text for display in a browser program.

### Student C

Study this information about some programming languages. Be ready to use this information in the discussion with Student A and Student B

<b>XML</b>	Stands for extensible Markup Language; XML is a metalanguage for creating webpages with meaningful data that can be used by a variety of programs
<b>C++</b>	C++ is an object-oriented superset of C which combines the best features of a structured high-level language and an assembly language - that is, it's relatively easy to code and uses computer resources efficiently. C was originally designed to write systems software but is now considered a general purpose language.
<b>Visual Basic</b>	BASIC stands for Beginners' All-purpose Symbolic Instruction Code; Visual Basic is a simple-to-use language that has a graphical interface. It makes it particularly easy for an inexperienced programmer to create database programs.

### Student D

Study this information about some programming languages. Be ready to use this information in the discussion with Student A and Student B

<b>Pascal</b>	Pascal, named after the mathematician Blaise Pascal, was created primarily to fill the need for a teaching vehicle that would encourage structured programming. It is often used in college computing courses
<b>COBOL</b>	Stands for COmmon Business-Oriented Language; it has been around for a long number of years but is still an important



	transaction-processing language used to process the records of large organizations on mainframe computers
<b>FORTRAN</b>	Stands for FORMula TRANslator; FORTRAN was designed by scientists in 1954 and is oriented toward manipulating formulas for scientific, mathematical, and engineering problem-solving applications.

2) Together decide what would be the most appropriate language to use for each of these situations and explain why you think so.

- a. A schoolteacher wants his young pupils to learn some basic mathematics by controlling a simple robot.
- b. The owner of a small business wants to create a simple database program to keep track of his stock.
- c. An engineer wants to develop a program for calculating the stresses in a mechanical device.
- d. A student wants to create webpages for a personal website.
- e. A systems programmer wants to add some new modules to an operating system.
- f. A programmer working for the US army wants to create a program for controlling a new type of weapon.
- g. A finance company needs to process data from its branch offices on its mainframe computer.
- h. A website designer wants to enable the data on his website to be easily processed by a number of different programs.
- i. A student studying artificial intelligence wants to write some programs for a course project.
- j. A college lecturer wants his students to learn the principles of programming.
- k. A professional programmer wants to create and sell a program for use in language learning.
- l. A website designer wants to password-protect a section of a website.

Make use of the above mentioned phrases of certainty and uncertainty to help you express your point of view.

<b>Certainty</b>	<b>Uncertainty</b>
I'm absolutely convinced that...	I'm not sure about it...
I'm sure that...	I doubt it...
I have no doubt that...	I'm not really sure about...
There's no doubt that...	I don't know for sure...
I think...	It's very unlikely...
I feel that...	I have my own doubts.
In my opinion...	I don't think so...
In my view...	I don't believe this is true...
I tend to think that...	There's some doubt in my mind that

I suppose that...	...
It seems to me that...	I'm not a hundred percent sure...
As far as I know...	▪ I don't know yet...
As far as I understand...	I am not sure/certain, but...
	▪

## WRITING

This writing section focuses on conditional instructions - structures commonly used in programming i.e. if a certain condition is true, then process this instruction: *If X, then Y*. Decision tables are used to indicate how a conditional structure will process data. They show all the different inputs that might arise for each condition and the resulting outputs that would be produced by the conditional instruction.

1) Study this decision table.

It shows the rules that are applied when certain conditions occur and what actions to take. (Y – yes, N – no)

Conditions	Decision rules	
	1	2
guest stays three nights	Y	Y
1 night is Sunday	Y	N
month is January	Y	N
Actions		
Charge 3 nights at full price	N	Y
Charge 2 nights at full price	Y	N
Charge 1 night at half-price	Y	N

Using it we can make rules like these ones:

1. If a guest stays 3 nights in January and if one night is Sunday, then charge 2 nights at full price and 1 night at half-price.
2. If a guest stays 3 nights and one night is not Sunday and it is not January, then charge 3 nights at full price.

2) Now, make similar statements about the decision table below.

Conditions	Decision Rules					
	1	2	3	4	5	6
guest books bed and breakfast	Y	Y	Y	N	N	N
guest books half-board	N	N	N	Y	Y	N
guest books full-board	N	N	N	N	N	Y

and guest has lunch	N	Y	N	N	Y	-
and guest has dinner	N	N	Y	-	-	-
<b>Actions</b>						
charge rate A	Y	Y	Y	N	N	N
charge rate B	N	N	N	Y	Y	N
charge rate C	N	N	N	N	N	Y
Charge menu price less 20%	N	Y	Y	N	Y	N

Start in the following way:

1. If a guest books bed and ... and has no other meal, then charge ...
2. If a guest ... and also has lunch, then ... rate A plus menu ... 20%.
3. If ...
4. If a guest books half-board and ...
5. If...
6. If a guest books full-board, then ...

## LISTENING

### SETTING THE CONTEXT

1. How many programming languages do you know? What is your favorite programming language and why? What languages are the most difficult to master in your opinion?
2. At what age did you start playing around with coding? Have you ever been part of any coding hackathons / projects?
3. Most programming languages are developed for specific reasons (e.g. C++ for writing system software, Cobol for business applications etc.), but there are also some bizarre languages (Whitespace, Cow etc.). What do you know about them? What are they for?
4. What programming languages are you planning to learn next year?

### ACTIVATING VOCABULARY

**Match the English words (phrases) with their Russian equivalents.**

8. downside	h) в сочетании с чем-либо
9. complex	i) сбивающий с толку
10. honorable	j) единственно, исключительно, только
11. in conjunction with sth/sb	k) отрицательная сторона
12. confusing	l) сложный
13. solely	m) уважаемый

**Before proceeding to CHECKING YOUR UNDERSTANDING section, please follow the link to watch the video:**

<https://www.youtube.com/watch?v=wgiW1uFZYr8>

*CHECK YOUR UNDERSTANDING:*

**Match the words from column A with the words from column B to form phrases:**

11.a software	k) used in conjunction with other languages
12.problem-solving	l) cross-platform
13.apply	m) mentions
14.to align	n) choice
15.job	o) engineer
16.to be	p) ability
17.optimal	q) with smb's interests
18.to be	r) market
19.honorable	s) for a job

**Circle the best answer to these questions.**

1. What is more important if you want to work for an IT company?
  - Your education
  - Your personal projects
  - Your work experience
2. What kind of companies tend to care a lot about which specific language you know:
  - IT giants
  - Start-ups
  - Non-governmental organizations
3. If you are interested in making an iPhone application you should learn
  - Javascript
  - Swift
  - Ruby
4. Python is a good choice for those who are interested in \_\_\_\_\_.
  - data science
  - machine learning
  - mobile app development
5. What is easier to learn:
  - Javascript

- C++
  - Not stated
6. What is the main downside of SWIFT:
- It is not cross-platform
  - It isn't easy to get a job for those who know Swift
  - It isn't an easy language to learn
7. Put the programming languages in the same order as they are listed in the video:
- Ruby
  - Swift
  - Java
  - Python
  - Javascript
8. What is the correct way to pronounce the word "SQL":
- [ 'ɛs kju: 'ɛl ]
  - [ 'si:kwəl ]
  - All above

## UNIT 8

### ARTIFICIAL INTELLIGENCE AND NEURAL NETWORKS

#### START-UP

##### 1. Answer the questions.

1. When someone mentions “artificial intelligence” (AI), what is the first thing that comes to your mind?
2. Do you know what a neural network is? Have you ever heard about machine learning?

#### VOCABULARY

##### 1. Match the words to their definitions.

- |                            |  |
|----------------------------|--|
| 1) artificial intelligence | a) the main points of smth. that has been discussed earlier  |
| 2) to interact             | b) a belief or opinion that you develop from the information that you know   |
| 3) rational                | c) a computer system or a type of computer program that is designed to copy the way in which the human brain operates                  |
| 4) machine learning        | d) something that you accept as true without question or proof   |
| 5) buzz                    | e) a small device or machine with a particular purpose   |
| 6) neural network          | f) the ability of a machine or a computer to think, act and learn like humans  |
| 7) assumption              | g) to communicate with or react to smth.   |
| 8) gadget                  | h) the process of computers carrying out tasks by learning from new data, without a human giving instructions in the form of a program |
| 9) inference               | i) excited, usually positive, talk about something or someone  |
| 10) recap                  | j) reasonable or sensible  |

##### 2. Match the synonyms given below.

- |                 |                |
|-----------------|----------------|
| 1) mission      | a) present     |
| 3) smart        | c) whole       |
| 4) current      | d) frightening |
| 5) intervention | e) forecast    |

- 6) entire
- 7) scary
- 8) anticipate
- 9) infancy
- 10) virtually

- f) clever
- g) beginning
- h) task
- i) interference
- j) artificial

**3. Complete the table with the necessary derivatives. Pay attention to the meaning of the words.**

<b>Verb</b>	<b>Noun</b>	<b>Adjective</b>
interact		
	breadth	
		rational
interchange		
	access	
		recognizable
assist		
	action	
		inferable
automate		

## **READING**

**1. Read the text and answer the questions.**

1. What is artificial intelligence (AI)? When did it appear?
2. Is there any difference between AI and machine learning?
3. Where is AI used?
4. Will AI take over?

### **Artificial Intelligence**

The term “artificial intelligence” dates back to 1956 and belongs to a Stanford researcher John McCarthy, who coined the term and defined the key mission of AI as a sub-field of computer science.

Basically, artificial intelligence (AI) is the ability of a machine or a computer program to think and learn. The concept of AI is based on the idea of building machines capable of thinking, acting, and learning like humans.

A more nuanced definition is that artificial intelligence is an interdisciplinary concept that studies the possibility of creating machines capable of interacting with their environment and acting upon the received data in the manner considered intelligent.

While some people falsely consider AI a technology, the more accurate approach would be seeing it as a broad concept in which machines are able to deal with tasks in a way we would call intelligent or smart.

There are certain things a machine/computer program must be capable of to be considered AI.

First, it should be able to mimic human thought process and behavior. Second, it should act in a human-like way – intelligent, rational, and ethical.

AI is not the same as machine learning. Although the two terms are often used interchangeably, they are different. Artificial intelligence is a broader concept, while machine learning is the most common application of AI. We should understand machine learning as a current application of AI that is focused on development of computer programs that can access data and learn from it automatically, without human assistance or intervention. The entire machine learning concept is based on the assumption that we should give machines access to information and let them learn from it themselves.

Artificial intelligence, in its turn, is a bunch of technologies that include machine learning and some other technologies like natural language processing, inference algorithms, neural networks, etc.

Many people associate AI with the distant future. They incorrectly believe that despite all the buzz around artificial intelligence, the technology is not likely to become a part of their lives anytime soon. Little do they know how many aspects of their lives are already affected by AI.

There are intelligent gadgets able to recognize our speech (read: “understand what we want or need”), analyze the information they have access to, and provide an answer or solution. What is remarkable (and a little scary) about such assistants is that they continuously learn about their users until the point at which they are able to accurately anticipate users’ needs.

Spotify, Pandora, and Apple Music are some other touching points between AI and you. These services are capable of recommending music based on your interests. These apps monitor the choices you make, insert them into a learning algorithm, and suggest music you are most likely to enjoy. This particular use of AI is probably one of the simplest among all, but it does a good job helping us discover new songs and artists.

AI is making headway in areas you might least expect it. The current state of artificial intelligence already allows for some basic robot writing. It might be not yet ready to compose in-depth articles or creative stories, but does a pretty good job writing short and simple articles like sport recaps and financial summaries.

Other examples of artificial intelligence in use today include smart home devices like Google’s NEST, self-driving cars like those produced by Tesla, and online games like Alien: Isolation.

Some people claim that AI is still in its infancy. Others assure us that we are only a few years away from AI gaining control over humanity. The truth, however, lies somewhere in between. According to the most trustworthy forecasts out there, AI will outsmart humans at virtually everything in the following 45 years.



Obviously, this won't happen overnight. Industries will be falling under AI's spell one-by-one. Experts predict that within the next decade AI will outperform humans in relatively simple tasks such as translating languages, writing school essays, and driving trucks. More complicated tasks like writing a bestselling book or working as a surgeon, however, will take machines much more time to learn. AI is expected to master these two skills by 2049 and 2053 accordingly.

<https://stopad.io/blog/artificial-intelligence-facts>

## 2. Read the text again and say whether these statements are true or false.

1. Artificial intelligence is a relatively new field of cognitive science.
2. AI is identical to machine learning.
3. AI is not likely to become a part of our lives soon.
4. Intelligent gadgets analyze information and are able to accurately anticipate users' needs.
5. AI has limited application.
6. AI will outperform humans in all spheres.

## 3. Make a short summary of the text.

### LANGUAGE FOCUS

#### *PASSIVE VOICE REVIEW*

Consult grammar rule using the link:

<https://drive.google.com/file/d/15WVmOHULtI2M8ULa2D5-26X9CdmLFPZ/view?usp=sharing>

## 1. Complete the sentences using one of the verbs from the box.

are used, was created, will be taken, are built, are coordinated, is composed, was proposed, can be embedded
---

1. Artificial neural networks \_\_\_\_\_ like human brain, with neuron nodes interconnected like a web.
2. The Turing Test \_\_\_\_\_ in a paper published in 1950 by mathematician and computing pioneer Alan Turing.
3. A chatbot is an Artificial Intelligence feature that \_\_\_\_\_ and used through any major messaging applications.
4. Deep Learning algorithms \_\_\_\_\_ by PayPal company to predict fraudulent transactions.
5. For example, if the image \_\_\_\_\_ of 30 by 30 pixels, then the total number of pixels will be 900.
6. Some people fear that if Strong AI becomes a reality, many jobs \_\_\_\_\_ away from people.

7. All the programs on a computer \_\_\_\_\_ by the Operating System.
8. Linux \_\_\_\_\_ by Finish programmer Linus Torvalds in 1991.

**2. Read the text and define all the subject, verb and object structures. Then rewrite the text using Present Simple Passive verbs.**

Computer scientists create Artificial Neural Networks (ANN) for different purposes. ANN detect and delete spam from a user’s inbox. ANN personalize recommendations to the consumers at e-commerce platforms. Facebook develops machine learning chatbots to simulate human conversation with customers. Deep learning algorithms with ANN predict the likelihood of an event. AI platforms built on ANN simplify transactions in fintech sector.

**3. Complete using the correct form of the verbs in brackets (Simple Tenses).**

1. The concept behind Neural Networks \_\_\_\_\_ (base) on the functioning of the human brain.
2. Construct 3: game making software \_\_\_\_\_ (launch) in 2017. It \_\_\_\_\_ (write) to run entirely in the browser.
3. Last year, over 94billion apps \_\_\_\_\_ (download) globally from Play App Store.
4. In the coming years, a virtual library of games with support from cloud servers \_\_\_\_\_ (access) by more consumers.
5. Indie games don’t usually have massive budgets and \_\_\_\_\_ (develop) by small teams.
6. It \_\_\_\_\_ (announce) that the next International Dota Championship \_\_\_\_\_ (hold) in Stockholm, Sweden.
7. The automated Java to Kotlin converter \_\_\_\_\_ (include) in the Kotlin plugin.
8. When Microsoft first released Windows 3.0 in 1990, it \_\_\_\_\_ (consider) revolutionary.

**4. Match to make sentences.**

1. Artificial neural networks	a) is currently being used in healthcare industry for dosing drugs.
2. The digital payment norm	b) has been introduced by cloud storage.
3. Artificial intelligence	c) it had been adjusted.
4. In October 2019 it was announced that	d) has been changed by cryptocurrency.
5. Some popular and commercial games	e) have been applied by many companies.
6. Another level of data retention	f) “Quantum Supremacy” had been achieved by Google.

7. Before we released the game	g) have been built using the Unity Game Engine.
--------------------------------	---

**5. Choose the best option.**

1. Many companies only introduce innovations after the concepts *have been tried out / is tried out / has been tried out* by smaller studios and received positively.
2. During the training stage the Artificial Neural Network *is teach / are taught / is taught* what to look for and what its output should be.
3. Nowadays machine learning *was being used / is being used / were used* in data analytics to make sense of big data.
4. A new meaning of the word convenience *has created / have been created / has been created* by e-commerce.
5. In 2001, data science *was being introduced / was introduced / has been introduced* as an independent discipline.
6. After our company information *have verified / has been verified / had been verified* we could start to set up our first product.
7. Amazing progress *was being make / was made / was being made* when this team of developers got involved in the project.

**6. Transform the sentences using the verbs either in the Active or Passive Voice.**

1. Users are sharing vast amounts of data through apps, social networks, and websites.
2. Android has expanded the choice of phones available around the world.
3. Full flight information is identified from your face by face recognition system at Chinese airports.
4. Businesses integrate chatbots with websites and messaging apps to automate their regular tasks.
5. The large volume of digital data is being used by companies to deliver better and smarter services to the people.
6. Linux was created by the Finnish programmer Linus Torvalds in 1991.
7. Nowadays the airports across the globe are introducing facial recognition to improve security.
8. Chatbots have also been acknowledged by many companies as an excellent resource for collecting and sharing relevant information.
9. Usersnap is a collaboration space where bugs are reported and visual feedback is collected, shared and discussed by the users.
10. Quality assurance (QA) teams have applied AI in predicting test quality, classifying defects, interacting with apps under tests, and so on.
11. Numerous other technologies, including the Internet of Things, augmented reality, virtual reality, blockchain and 3D printing will influence AI's development, adoption and regulation.

12. Unlike most other programming languages, Python does not utilize curly brackets for delimiting code blocks.

### 7. Correct the mistakes.

1. Mac OS is only find on Apple's iMac and MacBook computers.
2. Complex financial algorithms was testing thoroughly to ensure the programs were without errors.
3. Have Artificial Intelligence technology adopted by financial sector already?
4. Soon the need for traditional trade advisors will reduce by robo advisors.
5. The whole last month the workloads for various machines are recorded and analyzed to optimize the performance.
6. Recently, the findings from data analytics was utilized by nearly every department in the company.
7. Big data also collects from sensors and other inputs in smart devices.
8. As the use of AI becomes increasingly widespread a large number of jobs will automate.
9. Today more than 50 programming languages is actively using.
10. Deep Learning and Machine Learning technology had used by PayPal company for around 10 years.

### SPEAKING

Artificial intelligence is rapidly assimilating itself into people's lives. The incorporation of AI into our daily routines has managed to make living easier and convenient. Today, AI is very much a reality as products use machine learning for a variety of uses - assistance, biometrics, speech recognition and manufacturing, among others.

### Role Play and Discussion

- 1) Get into groups of three or four (A, B, C, and / or D).
- 2) Act according to your role task and speak in favour of the AI technology from your task.

#### Student A

#### Intelligent Personal Assistant

You think an intelligent personal assistant is the best technology. Tell the others three reasons why. Tell them things that are wrong with their things. Also, tell the others which is the least useful of these technologies and why:

- an AI-powered search engine for researchers and scientists;
- systems capable of flagging content on Facebook to fight against terrorism;
- a concealed weapons detection system.

Prior to the class, first, study the following internet resources to help you with the

reasons why an intelligent personal assistant is the best technology:  
<https://hackernoon.com/ai-or-machine-learning-technologies-flourishing-in-fields-where-you-least-expected-7697ff9da90a>

**Student B**

**AI-Powered Search Engine for scientists**

You think an AI-powered search engine for researchers and scientists is the best technology. Tell the others three reasons why. Tell them things that are wrong with their things. Also, tell the others which is the least useful of these technologies and why:

- an intelligent personal assistant,
- systems capable of flagging content on Facebook to fight against terrorism,
- a concealed weapons detection system

Prior to the class, first, study the following internet resources to help you with the reasons why an AI-powered search engine for researchers and scientists is the best technology:

<https://hackernoon.com/ai-or-machine-learning-technologies-flourishing-in-fields-where-you-least-expected-7697ff9da90a>

**Student C**

**Facebook Anti-Terrorist System**

You think anti-terrorist systems on Facebook are the best technology. Tell the others three reasons why. Tell them things that are wrong with their things. Also, tell the others which is the least useful of these technologies and why:

- an AI-powered search engine for researchers and scientists;
- Intelligent Personal Assistant;
- a concealed weapons detection system.

Prior to the class, first, study the following internet resources to help you with the reasons why Facebook Anti-Terrorist System is the best technology:

<https://hackernoon.com/ai-or-machine-learning-technologies-flourishing-in-fields-where-you-least-expected-7697ff9da90a>

**Student D**

**Concealed Weapon Detection System**

You think a concealed weapon detection system is the best technology. Tell the others three reasons why. Tell them things that are wrong with their things. Also, tell the others which is the least useful of these (and why):

- an AI-powered search engine for researchers and scientists,
- systems capable of flagging content on Facebook to fight against terrorism,
- an intelligent personal assistant;

Prior to the class, first, study the following internet resources to help you with the reasons why a concealed weapon detection system is the best technology:

<https://hackernoon.com/ai-or-machine-learning-technologies-flourishing-in-fields-where-you-least-expected-7697ff9da90a>

## WRITING

Make a written presentation of the technology you have spoken in favour of. Make sure to cover the following information:

- Is it already in use?
- What is it used for?
- How does it operate?
- Who are the developers?

## LISTENING

### *SETTING THE CONTEXT*

1. What challenges does modern AI face?
2. What types of Artificial Intelligence do you know? What is the difference between narrow AI and strong AI?
3. Comment on the following quote. Express your views on the future of AI.

“We’re at the beginning of a golden age of AI. Recent advancements have already led to invention that previously lived in the realm of science fiction — and we’ve only scratched the surface of what’s possible.”

Jeff Bezos, Amazon CEO

### *ACTIVATING VOCABULARY*

**Match the English words (phrases) with their Russian equivalents.**

1. commonplace	a) массив данных
2. to recognise	b) браться, приниматься с усердием за что-л.; пытаться найти решение (каких-л. вопросов)
3. inference	c) причинная связь, причинно-следственные отношения
4. to tackle	d) узнавать, распознавать; осознавать
5. dataset	e) обычное явление, привычное дело, типичный случай
6. to unravel	f) полагаться на что-л.
7. causation	g) вывод, заключение, умозаключение
8. to be reliant on sth.	h) выявлять; обнаруживать, разгадывать

**Before proceeding to CHECKING YOUR UNDERSTANDING section, please follow the link to watch the video:**

<https://www.youtube.com/watch?v=rkmz7DAA-t8>

*CHECK YOUR UNDERSTANDING:*

**Match the words from column A with the words from column B to form phrases:**

1. computational	1. cause and effect
2. to crunch	2. fields
3. recognising and	3. correlation
4. fundamental	4. approaches
5. the dynamics of	5. methods
6. traditional	6. challenge
7. scientific	7. big data
8. statistical	8. comparing patterns

**Circle the best answer to these questions.**

1. Machine learning is used in applications like Spotify and Netflix to \_\_\_\_
  - bring down the latency and assure smooth play of videos.
  - give you access to millions of songs and films.
  - help predict your media preferences.
  
2. Deep learning is mainly focused on \_\_\_\_
  - causal deconvolution.
  - classification and statistical correlation.
  - selection, recombination, and mutation to evolve a solution to a problem.
  
3. What may be called a fundamental challenge across all scientific fields nowadays?
  - Understanding the dynamics of cause and effect.
  - Recognizing and comparing patterns.
  - Implementing probabilistic search methods.
  
4. Causal deconvolution by algorithmic generative models means
  - breaking down complicated and interconnected datasets to look at the underlying mechanisms or code that generate them.
  - perceiving the environment and taking actions that maximize the chances of success.
  - supervised and parameter-based model-oriented approach.
  
5. Modern machine learning can \_\_\_\_
  - tell us much about how natural phenomena are formed.
  - identify objects by comparing their features to previous examples it's been shown.
  - none of the above.

6. A revolutionary new form of machine learning can help
  - in fields such as genetics and cell biology.
  - understand how a thunderstorm forms.
  - choose videos to be streamed on Netflix.



## UNIT 9 IMAGE RECOGNITION

### START-UP

#### 1. Answer the questions.

1. Do you think a computer can detect images as well as a person can?
2. Why should we use image detection and recognition?

### VOCABULARY

#### 1. Match the words to their definitions.

- |                         |  |
|-------------------------|--|
| 1) to capture           | a) the act or process of changing something from one position to another, or of exchanging the positions of two things |
| 2) machine vision       | b) an environment which is produced by a computer and seems very like reality to the person experiencing it            |
| 3) salient              | c) a sign on the front and back of a vehicle that shows its license number   |
| 4) image classification | d) a type of machine learning concerned with artificial neural networks allowing advanced pattern recognition          |
| 5) surveillance         | e) a word, idea, or activity which has recently become extremely popular   |
| 6) buzz                 | f) continuous observation of a place, person, group, or ongoing activity in order to gather information                |
| 7) deep learning        | g) a process in computer vision that can classify an image according to its visual content                             |
| 8) license plate        | h) especially noticeable or relevant   |
| 9) virtual reality      | i) the ability of a computer to see  |
| 10) transposition       | j) to catch, to grab   |

#### 2. Match the synonyms given below.

- |                    |               |
|--------------------|---------------|
| 1) to identify     | a) to input   |
| 2) man-made        | b) help       |
| 3) to select       | c) to trace   |
| 4) assistance      | d) artificial |
| 5) replacement     | e) progress   |
| 6) to grant access | f) benefits   |
| 7) advancement     | g) change     |

- 8) to track
- 9) perks
- 10) to feed

- h) to chose
- i) to allow access
- j) to detect

**3. Complete the table with the necessary derivatives. Pay attention to the meaning of the words.**

Verb	Noun	Adjective
	advancement	
isolate		
		trained
localize		
	replacement	
		visual
transpose		
	adoption	
		searchable
engage		

## READING

**1. Read the text and answer the questions.**

1. What is image recognition?
2. How does image recognition work?
3. How image recognition is used in business?
4. What are the benefits of image recognition?

### Image Recognition

Image recognition is the ability of a computer powered camera to identify and detect objects or features in a digital image or video. It is a method for capturing, processing, and examining images. To identify and detect images, computers use machine vision technology that is powered by an artificial intelligence system. A typical image recognition algorithm includes the following: optical character recognition; pattern matching and gradient matching; face recognition; license plate matching; scene identification.

Image recognition technology works by detecting salient regions, which are portions that contain the most information about the image or the object. It does this by isolating the most informative portions or features in a selected image and localizes them, while ignoring the rest of the features that may not be of much interest. The process uses an image recognition algorithm, also known as an image classifier, that takes an image as input and outputs what the image contains. For an algorithm to know what an image contains, it has to be trained to learn the

differences between classes. For instance, if the goal of an image recognition system is to detect and identify dogs, the image recognition algorithm needs to be trained with thousands of images of dogs and thousands of images of backgrounds that do not contain any dogs.

In the commercial world, the major applications of image recognition are face recognition, security and surveillance, visual geolocation, object recognition, gesture recognition, code recognition, industrial automation, image analysis in medical and driver assistance. These applications are revolutionizing the business world, across many industries, and here's how:

### **In E-commerce**

Image recognition has been highly adopted in e-commerce, including search and advertising. Today, mobile applications use the technology to identify specific products, providing potential customers with a more engaging experience of the world around them. It presents a more interactive view of the world by making everything searchable.

### **Business process management**

Image recognition technology can assist in the identification process during business operations. An example of this would be the replacement of traditional ID cards with Face ID. In the workplace, this can be used to determine if a person is granted access to official work documents or simply to check in. Another example where image recognition is applicable for efficient business operations is in the manufacturing process. Machines equipped with image recognition can automatically detect defective products in the manufacturing pipeline.

### **Automotive industry**

Self-driving cars are the buzz in the automotive industry and are already being tested in the U.S. and other parts of the world. These advancements in the automobile world are made possible by computer vision technology which uses AI image recognition. Computer vision systems powered by deep learning are trained using thousands of images such as road signs, pathways, moving objects, vehicles, and people and are fed into the systems neural networks. The systems get intelligent as more training data is fed into the system and this is how autonomous driving is enabled.

Image recognition can really help you with digital marketing. By integrating the application's programming interface to your text-based analytics platforms, you will be able to offer visual insights to your customers without the expensive product creation that uses logo detection. Image recognition can also help you monitor ROI and protect your brand. You will be able to track how a sponsorship is doing with image and logo detection and this will help you determine how much revenue you will get in return. Therefore, integrating an image recognition application programming interface is an easy way of giving your customers the best service.

When using image recognition, you can easily transpose digital information. As opposed to virtual reality, image recognition doesn't replace your environment with a digital one, instead, it adds more perks to it. In addition, you can easily

organize your visual memory. Image recognition software can help you make mental notes through visual. If you take an image, its computer vision will match up with the visual background information, meaning that you can get information about wine bottles, books, DVDs, and many more by simply taking a photo of their covers or labels. When you have these images in your computer, you can then search for the information they contain, counting on keywords, location etc.

<https://sightcorp.com/knowledge-base/image-recognition/>

**2. Read the text again and say whether these statements are true or false.**

1. An artificial intelligence system is used to identify and detect images.
2. A typical image recognition algorithm can only identify faces.
3. Image recognition technology works by detecting minor regions of the object.
4. An image classifier trained to learn the differences between classes takes an image as input and outputs what the image contains.
5. The major applications of image recognition are revolutionizing the business world across many industries.
6. Machines equipped with image recognition still need an operator to detect defective products in the manufacturing pipeline.
7. Image recognition can help you monitor your profit from investments.
8. When using image recognition, it is hard to transpose digital information.

**3. Make a short summary of the text.**

**LANGUAGE FOCUS**

*MODAL VERBS*

Consult grammar rule using the link:

[https://drive.google.com/file/d/1l61Hu\\_Q9KswH\\_TbVqFs\\_pUtvUK9WEMWb/view?usp=sharing](https://drive.google.com/file/d/1l61Hu_Q9KswH_TbVqFs_pUtvUK9WEMWb/view?usp=sharing)

**1. Match the speech situations with the proper sentences.**

1. Ability in the present	a. Could I use your charger?
2. Ability in the past	b. This car can drive in an autopilot mode.
3. Asking permission	c. Could you debug the program?
4. Asking permission politely	d. She could still be at work.
5. Polite request	e. Can I download this app?
6. Possibility	f. At school Bill Gates became entranced with what a computer could do.

**2. Fill in: *can, can't, could, couldn't, will be able to* (for expressing general or specific ability).**

1. Some people are afraid of AI technology, others \_\_\_\_ wait to see AI-powered machines.
2. Bill Gates quickly impressed IBM convincing them that he and his company \_\_\_\_ meet their needs.
3. Steam users \_\_\_\_ see what their friends are doing in the game.
4. Developers hope that in the near future an AI system \_\_\_\_ work with visual content more properly.
5. Google Cloud Vision API \_\_\_\_ detect and extract information about entities in an image, across a broad group of categories.
6. Unfortunately, last time the system \_\_\_\_ identify different objects in the image with high accuracy.
7. Soon you \_\_\_\_ build your own object detection system using Image AI.
8. If the system \_\_\_\_ classify image items, it should be further trained.

**3. Complete the sentences using *could, couldn't, was / were able to* (for expressing general or specific ability).**

1. Denis \_\_\_\_ buy this phone case because it had been sold out.
2. When Nick was 13, he loved programming. He \_\_\_\_ build his first programmable robot with LEGO MINDSTORMS.
3. The topic was rather difficult but I \_\_\_\_ understand the idea.
4. Yesterday an AI powered drone inspected the wind turbine and \_\_\_\_ detect some defective components.
5. Last year we \_\_\_\_ easily find a lot of fascinating places in Italy thanks to GPS navigator.
6. The task was so monotonous that the workers \_\_\_\_ keep up with the rate of product output.
7. As there was nobody to disturb us in the lab, we \_\_\_\_ complete the measurements.

**4. Complete the sentences. Use *could* or *could have* and a suitable verb from the box to express possibility.**

**buy, download, be, integrate, go, take, meet**

1. – Where's Kate? – She \_\_\_\_ in a meeting.
2. – Are you still using Windows 7? You \_\_\_\_ the latest Windows 10 long ago.
3. – When shall we meet tomorrow? – Well, we \_\_\_\_ at 10 a.m.
4. – Did you go to the movies last night? – No, we \_\_\_\_ but we decided to stay at home.
5. – What challenges can manufacturers solve using AI tools? – For instance, manufacturers \_\_\_\_ neural networks to create automated visual inspections.

6. – Did you analyze every single image collected by the drone? – No, it \_\_\_\_ a lot of hours. An AI powered drone had filtered out 90% of data that was not of interest.

7. We \_\_\_\_ the necessary program, but we downloaded a free trial instead.

**5. Put in must (for something that is logically probable) or can't (for something that is logically improbable).**

1. There \_\_\_\_ be something wrong with the laptop! It's making a very unusual noise.

2. This \_\_\_\_ be Peter's smartphone. He's got a Samsung, but this one is a Huawei.

3. – Where's Pavel? – He \_\_\_\_ be in the office. His work starts at this time.

4. This technology is very smart. Its adoption \_\_\_\_ augment the quality of the product.

5. Ann \_\_\_\_ be at work because she never works on Sundays.

6. – You know, I boarded a flight without a boarding pass scan! – They obviously \_\_\_\_ have a facial recognition system at the airport.

7. These calculations \_\_\_\_ be correct! Twenty-seven plus eighteen doesn't equal forty-two.

**6. Put in mustn't or don't / doesn't have to (for expressing obligation).**

1. This online tutorial is free. You \_\_\_\_ pay to get it.

2. We \_\_\_\_ forget to switch off all the devices before we leave.

3. You \_\_\_\_ park the car here.

4. With the AI-powered drone you \_\_\_\_ do the initial review of the gathered images. The drone will filter out the data that is not of interest.

5. Alex \_\_\_\_ go to the university on Sundays.

6. We have a lot of work tomorrow. You \_\_\_\_ be late.

7. Nick \_\_\_\_ miss the classes. He'll leave behind his groupmates.

8. They \_\_\_\_ rush. They've got a lot of time.

**7. Choose the best option.**

1. You \_\_\_\_ design the algorithm. It has been done already.

a) can't

b) don't have to

c) must

2. At the end of the course you \_\_\_\_ build your own app.

a) must have

b) can't

c) will be able to

3. No matter how busy you are, you \_\_\_\_ schedule time to walk out.
- a) must
  - b) couldn't
  - c) was able to
4. For every half-hour spent sitting in front of your computer you \_\_\_\_ take 2-3 minutes break.
- a) don't have to
  - b) should
  - c) were able to
5. Chatbots \_\_\_\_ be programmed for different platforms like Facebook, Twitter, WhatsApp.
- a) was able to
  - b) can't
  - c) can
6. The branches like Image Detection, Classification and Recognition \_\_\_\_ seem similar.
- a) might
  - b) must
  - c) should
7. To train AI tool to detect certain objects you \_\_\_\_ show these objects first.
- a) couldn't
  - b) can
  - c) have to
8. If you just need to find out the number of objects in the picture, you \_\_\_\_ use Image Detection.
- a) might have
  - b) was able to
  - c) should
9. We \_\_\_\_ modernize manual processes by automating them through the use of the biometric technology.
- a) is able to
  - b) can
  - c) must have
10. You \_\_\_\_ be late for the presentation.
- a) can't
  - b) don't have to
  - c) mustn't

## SPEAKING

Biometrics are part of the cutting edge of technology. Put simply, biometrics are any metrics related to human features. Biometrics are a way to measure a person's physical characteristics to verify their identity. These can include physiological traits, such as fingerprints and eyes, or behavioral characteristics, such as the unique way you would complete a security-authentication puzzle. To be useful, biometric data must be unique, permanent and collectible. Once measured, the information is compared and matched in a database.

### **Speak about the following preventive measures using the prompts.**

To do this decide on the relationship between the events in each of the process. Then link them using active and passive structures, prompts and patterns below.

#### **1 Face recognition**

- a. You approach a high-security network.
- b. Key features of your face are scanned.  
(*When ..., ... .*)
- c. The system matches your features to a database record of authorized staff.
- d. Your identity is verified.
- e. You can log on.  
(*If ..., ... allowing ... .*)
- f. Your identity is not verified.
- g. You cannot use the system.  
(*If ..., you are stopped ... .*)

Pattern:

*When you approach a ..., key features of your face ... . If the system ..., your identity ... allowing you to ... . If your identity ..., you are ... .*

#### **2 Voice recognition**

- a. Computers without keyboards will become more common.
- b. These computers are voice-activated.  
(*Voice-activated computers ... .*)
- c. The user wants to log on.
- d. He speaks to the computer.
- e. It matches his voice to a database of voice patterns.  
(*When ..., ... which ... .*)
- f. The user has a cold or sore throat.
- g. He can use the system.
- h. Stress and intonation patterns remain the same.  
(*If ..., is allowed ... because ... .*)

Pattern:

*Voice-activated computers ... . When ..., ... which ... . If ..., is allowed ... because ... .*



### 3 Eye scanning

- a. A person looks through eyepiece.  
(*To use a system or a device ...* )
- b. The laser scans the eye.
- c. The computer records microscopic details of the eye.
- d. It translates data into a unique barcode.  
(*After ..., ... and ...* .)
- e. The system matches it to the one in the database recorded originally.  
(*Then ...* .)

### 4 Hand scanning

- a. You select the language you wish to converse in.
- b. You insert ordinary credit card into the console.  
(*As soon as you ..., you ...* .)
- c. You insert hand to be scanned.
- d. The database starts checking your hand print with one on file.
- e. It checks to make sure your ID matches that on the credit card.  
(*After you ..., the database ... to ... if your ID ...* .)

Pattern:

*As soon as you ..., you ... . After you ..., the database ... to ... if your ID ... .*

## WRITING

Choose one of the technology from **Speaking**. Look for more information on the Internet and write a passage to describe it in more detail.

## LISTENING

### SETTING THE CONTEXT

1. What do you know about Artificial Intelligence?
2. How is deep learning related to machine learning?
3. Read the following brainy quotes. How do you understand them? Express your views on one of them.

*“AI is likely to be either the best or worst thing to happen to humanity.”*

*Stephen Hawking*

*“With artificial intelligence, we are summoning the demon.”*

*Elon Musk*

### ACTIVATING VOCABULARY

**Match the English words (phrases) with their Russian equivalents.**

1. subset	а) смещение, сдвиг
-----------	--------------------

2. to differentiate (between)	b) определять, устанавливать
3. core entity	с) величина, значение
4. layer	d) границы, пределы (возможностей, знаний и т. п.); область действия
5. value	e) основная сущность
6. bias	f) подмножество
7. MRI (Magnetic Resonance Imaging)	g) в особенности, больше всего
8. to replicate	h) разговаривать, общаться
9. notably	i) МРТ (магнитно-резонансная томография)
10. to converse	j) различать, проводить различие
11. to determine	k) повторять, имитировать
12. scope	l) слой

**Before proceeding to CHECKING YOUR UNDERSTANDING section, please follow the link to watch the video:**

<https://www.youtube.com/watch?v=6M5VXKLf4D4>

### ***CHECKING YOUR UNDERSTANDING***

**Match the words from column A with the words from column B to form phrases:**

1. hand-written	a) the surface
2. input	b) support
3. hidden	c) power
4. weighted	d) scope
5. customer	e) layer
6. self-driving	f) units
7. computational	g) digit
8. to scratch	h) layer
9. vast	i) channel
10. graphical processing	j) cars

### **Circle the best answer to these questions**

1. What is Artificial Intelligence?

- A technique that enables a machine to replicate human behavior;
- A computer system that emulates the decision-making ability of a human expert;
- The systemic computational analysis of data or statistics.

2. What is NOT mentioned in the text as the capabilities of deep learning?
  - To translate an entire webpage into a different language;
  - To group images based on their location;
  - To determine whether a piece of fruit in a photo is a banana or an apple.
  
3. According to the video deep learning is \_\_\_\_
  - a type of machine learning inspired by the structure of the human brain;
  - a technique that enables a machine to mimic human behavior;
  - a technique to achieve AI through algorithms trained with data.
  
4. How is machine learning different from deep learning?
  - In machine learning the needed data is conveyed to the machines by humans;
  - In machine learning features are picked out by the neural network without human intervention;
  - None of the above.
  
5. Which layer is located between the output layer and the input layer?
  - Hidden layer;
  - Service layer;
  - Persistence layer.
  
6. What is not listed in the video as a possible scope of application of deep learning?
  - Medical care;
  - Self-driving cars;
  - Food delivery.
  
7. What limitations does deep learning face?
  - A massive volume of data;
  - Computational power;
  - Long training time;
  - All above.
  
8. Some of the popular deep learning frameworks listed in the video include \_\_\_\_
  - TensorFlow;
  - Keras;
  - PyTorch;
  - Gluon.

## UNIT 10 SOFTWARE TESTING

### START-UP

#### 1. Answer the questions.

1. Why is software testing important?
- 2 Do you know what exactly a tester does?

### VOCABULARY

#### 1. Match the words to their definitions.

- |  |  |
|--|--|
| 1) tooling                                 | a) a set of routines, protocols and tools for building software applications   |
| 2) typo                                    | b) all of the activities that make a software system available for use   |
| 3) test script                             | c) a software and input devices by means of which a computer and its user communicate  |
| 4) to verify                               | d) an small mistake in a text made when it was typed or printed  |
| 5) deployment                              | e) question  |
| 6) bug                                     | f) a single software application designed as a suite of independently deployable small services                              |
| 7) UI (user interface)                     | g) set of instructions that will be performed on the system under <i>test</i> to check that the system functions as expected |
| 8) API (application programming interface) | h) a set of products that supports one or more test activities   |
| 9) query                                   | i) to prove to be true   |
| 10) microservices                          | j) a mistake in a computer program   |

#### 2. Match the synonyms given below.

- |                   |                        |
|-------------------|------------------------|
| 1) appropriate    | a) to instruct         |
| 2) to be prone to | b) expensive           |
| 3) error          | c) suitable            |
| 4) robust         | d) to be vulnerable to |
| 5) to replicate   | e) guarantee           |
| 6) costly         | f) strong              |

- 7) to implement
- 8) assurance
- 9) deployment
- 10) to brief

- g) to perform
- h) to copy
- i) mistake
- j) implementation

**3. Complete the table with the necessary derivatives. Pay attention to the meaning of the words.**

Verb	Noun	Adjective
		exploratory
automate		
	complexity	
		multiple
degrade		
	deployment	
		repeatable
save		
	assurance	
		behavioristic

## READING

**1. Read the text and answer the questions.**

1. What is the purpose of testing?
2. Why is manual testing costly?
3. How are tests classified?
4. What do integration tests check?
5. There is sometimes a confusion between integration tests and functional tests, isn't there?
6. What is the essence of end-to-end tests?
7. Why are acceptance tests formal?
8. Do performance tests check the behavior of the system under load?
9. How can one automate tests?
10. When is exploratory testing carried out?

### Different Types of Software Testing

There are many different types of testing that can be used to make sure that changes to the code are working as expected.

#### Manual vs. automated testing

Manual testing is done in person, by clicking through the application or interacting with the software and APIs with the appropriate tooling. This is very expensive as it requires someone to set up an environment and execute the tests

themselves, and it can be prone to human error as the tester might make typos or omit steps in the test script.

Automated tests, on the other hand, are performed by a machine that executes a test script that has been written in advance. These tests can vary a lot in complexity, from checking a single method in a class to making sure that performing a sequence of complex actions in the UI leads to the same results. It's much more robust and reliable than automated tests – but the quality of your automated tests depends on how well your test scripts have been written.

### **Different types of tests**

#### **Unit tests**

Unit tests are very low level, close to the source of your application. They consist in testing individual methods and functions of the classes, components or modules used by your software. Unit tests are in general quite cheap to automate and can be run very quickly by a continuous integration server.

#### **Integration tests**

Integration tests verify that different modules or services used by your application work well together. For example, it can be testing the interaction with the database or making sure that microservices work together as expected. These types of tests are more expensive to run as they require multiple parts of the application to be up and running.

#### **Functional tests**

Functional tests focus on the business requirements of an application. They only verify the output of an action and do not check the intermediate states of the system when performing that action.

There is sometimes a confusion between integration tests and functional tests as they both require multiple components to interact with each other. The difference is that an integration test may simply verify that you can query the database while a functional test would expect to get a specific value from the database as defined by the product requirements.

#### **End-to-end tests**

End-to-end testing replicates a user behavior with the software in a complete application environment. It verifies that various user flows work as expected and can be as simple as loading a web page or logging in or much more complex scenarios verifying e-mail notifications, online payments, etc.

End-to-end tests are very useful, but they're expensive to perform and can be hard to maintain when they're automated. It is recommended to have a few key end-to-end tests and rely more on lower level types of testing (unit and integration tests) to be able to quickly identify breaking changes.

#### **Acceptance testing**

Acceptance tests are formal tests executed to verify if a system satisfies its business requirements. They require the entire application to be up and running and focus on replicating user behaviors. But they can also go further and measure the performance of the system and reject changes if certain goals are not met.

#### **Performance testing**

Performance tests check the behaviors of the system when it is under significant load. These tests are non-functional and can have the various form to understand the reliability, stability, and availability of the platform. For instance, it can be observing response times when executing a high number of requests, or seeing how the system behaves with a significant amount of data.

Performance tests are by their nature quite costly to implement and run, but they can help you understand if new changes are going to degrade your system.

### **Smoke testing**

Smoke tests are basic tests that check basic functionality of the application. They are meant to be quick to execute, and their goal is to give you the assurance that the major features of your system are working as expected. Smoke tests can be useful right after a new build is made to decide whether or not you can run more expensive tests, or right after a deployment to make sure that they application is running properly in the newly deployed environment.

### **How to automate your tests?**

An individual can execute all the tests mentioned above, but it will be very expensive and counter-productive to do so. As humans, we have limited capacity to perform a large number of actions in a repeatable and reliable way. But a machine can easily do that rapidly and will test that login/password combination works for the 100th time without complaining. To automate your tests, you will first need to write them programmatically using a testing framework that suits your application.

### **Exploratory testing**

The more features and improvements go into your code, the more you'll need to test to make sure that all your system works properly. And then for each bug you fix, it would be wise to check that they don't get back in newer releases. Automation is key to make this possible and writing tests sooner or later will become part of your development workflow.

So the question is whether it is still worth doing manual testing? The short answer is yes, and it should be focused on what is called exploratory testing where the goal is to uncover non-obvious errors.

An exploratory testing session should not exceed two hours and need to have a clear scope to help testers focus on a specific area of the software. Once all testers have been briefed, is up to them to try various actions to check how the system behaves. This type of testing is expensive by nature but is quite helpful to uncover UI issues or verify complex user workflows. It's something especially worth doing whenever a significant new capability is added to your application to help understand how it behaves under edge cases.

Finally, it's important to talk about the goal of testing. While it's important to test that users can use your application (I can log in, I can save an object) it is equally important to test that the system doesn't break when bad data or unexpected actions are performed. You need to anticipate what would happen when a user makes a typo, tries to save an incomplete form or uses the wrong API. You need to check if someone can easily compromise data, get access to a resource

they're not supposed to. A good testing suite should try to break your app and help understand its limit.

And finally, tests are code too! So don't forget them during code review as they might be the final gate to production.

<https://www.atlassian.com/continuous-delivery/software-testing/types-of-software-testing>

## 2. Read the text again and say whether these statements are true or false.

1. Software testing is carried out to check that the programs in the computer are run correctly.
2. Manual testing is cheap.
3. Automated tests are more robust and reliable than manual ones.
4. Integration tests verify that different modules or services used by your application work well together.
5. Functional tests check the intermediate states of the system when performing an action.
6. End-to-end tests can be hard to maintain when they're automated.
7. Acceptance tests measure the performance of the system.
8. Smoke testing gives you the assurance that all minor features of your system are working as expected.
9. Exploratory testing helps understand how an application behaves under edge cases.
10. A tester should anticipate what would happen when a user makes a typo or uses the wrong API.

## 3. Make a short summary of the text.

### LANGUAGE FOCUS

#### *THE INFINITIVE*

Consult grammar rule using the link:

<https://drive.google.com/file/d/1ZYHqMR0JLasrUsRTIzLMUqnT4srXvdGB/view?usp=sharing>

#### 1. Insert *to* where necessary.

The goal of software testing is not \_\_\_\_ (find) bugs or \_\_\_\_ (make) software better. You can never \_\_\_\_ (find) all the bugs or defects in a piece of software and you can never \_\_\_\_ (test) every possible input into the software (for any non-trivial app). So, the main idea behind software testing is \_\_\_\_ (reduce) the risk that the customer is greatly impacted when using the software. Customers can \_\_\_\_ (be) impacted by the frequency of an error or by the severity of the problem. As a software developer, you should \_\_\_\_ (be) concerned with the quality of your code.



If you try \_\_\_\_ (test) your code thoroughly and \_\_\_\_ (find) a bug before you hand it over to a tester, it will let your team \_\_\_\_ (save) a lot of time in future.

**2. Complete the sentences. Use the correct form of the verbs in the box.**

produce, use, test, improve, identify, write, fix

1. Do you need this course \_\_\_\_ your testing skills?
2. User Interface testing is used \_\_\_\_ the look and feel of an application.
3. Software testing is performed \_\_\_\_ the quality product.
4. Katalon Studio, automation testing tool, is sophisticated enough \_\_\_\_ for both automated and exploratory testing.
5. Bugs are prioritized and sent to developers \_\_\_\_.
6. I've created some software test cases \_\_\_\_ the types of defects.
7. Selenium, automation testing tool, is flexible enough \_\_\_\_ test scripts in many different languages.

**3. Complete the second sentence so that it means the same as the first, using the word in bold.**

**Example:** *Paul reproduced and fixed the bugs with more detailed steps in the bug report. (allow)*

*More detailed steps in the bug report allowed Paul to reproduce and fix the bugs.*

1. We create test cases faster using hundreds of built-in keywords in Katalon Studio. (**let**)  
Hundreds of built-in keywords .....
2. I found a bug in the code with extra 10 minutes. (**enable**)  
Extra 10 minutes .....
3. The development manager says that you have to re-run the test to make sure the bug is valid. (**want**)  
The development manager .....
4. They use this automation tool to develop and test APIs (Application Programming Interface). (**allow**)  
This automation tool .....
5. The task was rather difficult and urgent, so I had to stay overtime at the office. (**make**)  
Rather difficult and urgent task .....
6. – Why don't you join our Quality Assurance team? (**would like**)  
I .....
7. QA teams generate better test cases with the help of Machine Learning applications. (**let**)  
Machine Learning applications .....

#### 4. Make a new sentence using the verb in brackets.

**Example:** *The code works on my machine. (seem)*

*The code seems to work on my machine.*

1. Machine Learning projects for testing are very promising. (**appear**)
2. The test scripts have been written. (**seem**)
3. Test automation tools improve test efficiency. (**prove**)
4. The concept of test automation has been applied for about 20 years. (**tend**)
5. In the entire mobile app development process, the most tedious and complicated task is app testing. (**turn out**)
6. My testing skills are getting better. (**seem**)

#### 5. Make a new sentence using the verb in brackets.

**Example:** A good AI-assisted tool generates test scenarios. (**say**)

A good AI-assisted tool is said to generate test scenarios.

1. Many organizations will implement ML projects in the coming year. (**know**)
2. Test automation tools have increase test coverage. (**suppose**)
3. Test automation is implemented in many QA processes. (**expect**)
4. Software testing evaluates the functionality of a software app. (**sure**)
5. Test costs have been reduced by applying test automation tools. (**report**)
6. AI will detect and eliminate redundant test cases. (**likely**)
7. API testing checks the functionality, reliability, performance and security of the app. (**know**)

#### 6. Correct the mistakes if necessary.

1. Security testing will continue be a popular topic in the following year.
2. Unit testing is done to be checked whether the individual modules of the source code are working properly.
3. Automation helped them reduce test cycle time.
4. Some companies are still not confident to enough invest in AI.
5. Handle with a vast amount of workload and information the organizations apply AI solutions.
6. Big data testing expects to become popular next year.
7. Test automation tools developers must continuously to update and upgrade tools to fulfill the QA teams demands.
8. Automated testing in QA processes is seemed to provide continuous feedback loops.
9. Important find defects in the early stages of the software development lifecycle.
10. Big data testing lets industries to deal with huge data volumes and diverse data types.
11. Be the first see what is coming and become part of the process.

12. Construct 3 can run on Windows, Macs and Linux machines.

## SPEAKING

Software Testing Exercises

### Exercise 1.

How many bugs can you find on this buggy windows calculator? To find the bugs, compare it to the correct one on your computer. Look for unknown words in a dictionary. Compare your answers with your partner.

Bug count: over 5



### Exercise 2

Find as many bugs as you can on this buggy windows calendar. Look for unknown words in a dictionary. Compare your answers with your partner.

Bug count: over 5

Create calendar: Year:  Year:  Country:

◀ November  January 2013 ▶

### Calendar for December 2013 (India)

December						
Mon	Tue	Wed	Thu	Fri	Sat	Sun
						1
2	3	4	5	6	7	8
9	10	11	12	13	14	15
16	17	18	19	20	21	22
23	24	25	26	27	28	29
30	31					

Phases of the moon: 3 ● 9 ○ 17 ○ 25 ○

Holidays and Observances: 2: 'St Andrew's Day' observed (Scotland), 25: Christmas Day, 26: Boxing Day

09:29  
01-01-2014

### Exercise 3

#### Weather app

Weather app has 2 screens. Screen 1 displays the weather forecast for the first 5 days of the week and screen 2 shows weather forecast for further 5 days. How many bugs can you find on this Weather Forecast screenlet? Compare your answers with your partner.

Bug Count: over 10



### WRITING

To detect bugs is not enough. An essential part of the testing process is to report (to document and send the bug to people in charge of fixing that error or failure). A bug report is a description (or a summary) of the bug which should clearly explain the problem. Different bug tracking apps use different bug report templates which can have a different layout.

Look through the examples of descriptions below.

#### [Pricing] - Update the price to \$29 #6

**Open** garygaspar opened this issue 13 minutes ago · 0 comments

garygaspar commented 13 minutes ago Owner

**Summary:**  
The price mentioned on the pricing page is not correct

**Steps to Reproduce:**  
Go to the pricing page

**Expected Results**  
The price for the basic plan should be \$29

**Actual Results:**  
The price for the basic plan is currently be \$25

## [Pricing] - Update the price to \$29

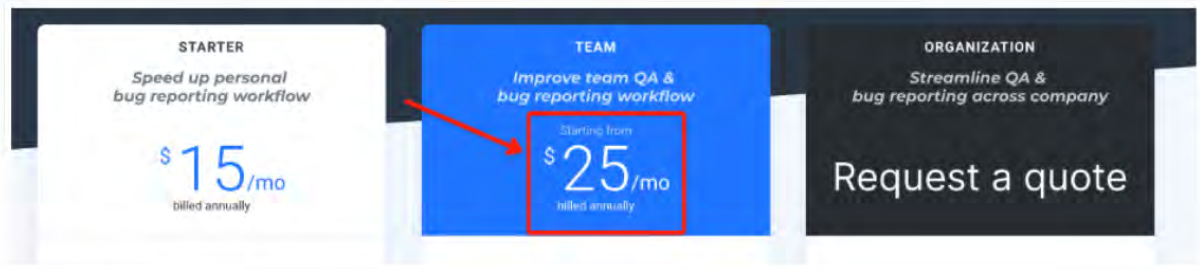

**Summary:** The price mentioned on the pricing page is not correct

**Expected Results:** The price for the Team plan should be \$29

**Actual Results:** The price for the Team plan should be \$25

	A	B	C
1	<b>Category</b>	<b>Label</b>	<b>Value</b>
2	Bug ID	ID number	#123
3		Name	CART - Unable to add new item to my cart
4		Reporter	Mike A
5		Submit Date	03/04/16
6	Bug overview	Summary	When my cart contains one item, I am unable to add a second item via the add to cart button on a product page
7		URL	www.example.com/product/abc
8		Screenshot	www.example.com/screenshot123
9		Platform	Macintosh

Make descriptions of some of the bugs from the Speaking section. Make use of a sample below.

### Calculator

#### A sample bug description

##### Summary:

There is no Iconify («Свернуть») button next to Minimize button in the top of the window.

##### Steps to reproduce:

Go to the calculator page.

##### Expected results:

There should be Iconify button on the right of Minimize button.

##### Actual results:

Iconify button is missing.

## LISTENING

### SETTING THE CONTEXT

1. What is testing? Why is software testing critical?

2. Some programmers believe that people with weak coding skills are assigned to testing. Are they right? Why/why not?

3. Paul R. Ehrlich once said:

***To err is human, but ...***

Make up 3 possible endings for this brainy quote.

4. Look at the picture. Do you know how this paradox is called in software testing?

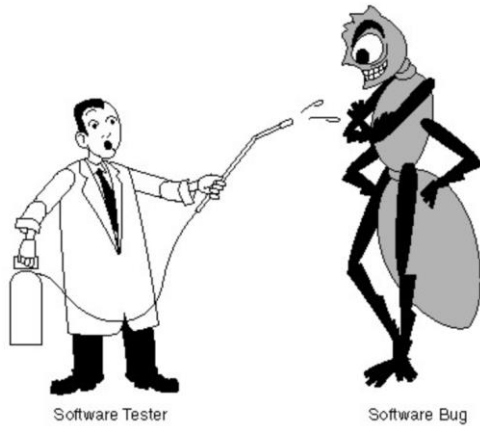

*ACTIVATING VOCABULARY*

**Match the English words (phrases) with their Russian equivalents.**

1. to release	a) возрастать в геометрической прогрессии
2. end-user	b) оценка рисков
3. defect free	c) ошибка, заблуждение
4. to malfunction	d) превозмочь; преодолеть
5. failure	e) доказательство правильности
6. bank account	f) резюме, краткое повторение
7. storage capacity	g) невыявленные дефекты
8. to rise exponentially	h) выпускать в свет
9. exhaustive testing	i) время осуществления проекта
10. risk assessment	j) конечный пользователь
11. to test thoroughly	k) удовлетворять потребности
12. to overcome	l) работать со сбоями
13. precautions	m) отвечать нуждам и потребностям клиента
14. undiscovered defects	n) объем памяти
15. proof of correctness	o) неудача, провал
16. meet the needs and requirements of the client	p) меры предосторожности
17. fulfill the user's needs	q) тщательно тестировать
18. fallacy	r) бездефектный

19.quick recap	s) банковский счет
20.project execution time	t) исчерпывающее тестирование

*FOCUS ON PHRASAL VERBS*

think over	to think about (something) for a period of time especially in an effort to understand or make a decision about it
foul up	to spoil by making mistakes

**Before proceeding to CHECKING YOUR UNDERSTANDING section, please follow the link to watch the video:**

<https://www.youtube.com/watch?v=goaZTAzsLMk>

*CHECK YOUR UNDERSTANDING*

**Match the words from column A with the words from column B to form phrases:**

1. public	a) the user's needs
2. to rise	b) off-the-shelf application
3. taking	c) extra hard
4. exhaustive	d) exponentially
5. storage	e) execution time
6. risk	f) and requirements of the client
7. fulfill	g) launch
8. work	h) testing
9. a commercial	i) all precautions
10.project	j) capacity
11.meet the needs	k) assessment

**Circle the best answer to these questions:**

1. Correctness, completeness and quality of developed computer software should be checked \_\_\_\_

- before the product is released to the end-users;
- right after the public launch of the product;
- by the customers.

2. What costly US accident is mentioned in the video?

- The failure to launch a 1.2 billion dollar military satellite;
- Crediting the bank accounts of 823 clients with 920 million u.s. dollars;
- The destruction of NASA Mars Polar Lander.

3. What is not listed as a possible scenario when you are moving a file from folder A to folder B?



- The file is infected with a virus;
  - Folder B already has a file with the same name;
  - You do not have the security rights to paste the file in folder B.
4. What is called exhaustive testing?
    - Software testing that makes you feel exhausted;
    - Testing performed by a machine that executes a test script;
    - A test approach in which all possible data combinations are used for testing.
  5. What is the “pesticide paradox”?
    - The phenomenon when the system is immune to any bugs;
    - The situation when a small number of modules contains most of the bugs detected;
    - The situation when the same tests are repeated over and over again, eventually the same set of test cases can’t no longer find any new bugs.
  6. What does “defect clustering” mean?
    - A small number of modules contain most of the defects;
    - Some modules don’t need to be tested;
    - Errors are evenly distributed between risky modules.
  7. Early testing helps prevent the system from \_\_\_\_
    - being full of errors;
    - having undiscovered defects;
    - being unusable.
  8. The seventh principle states that testing should \_\_\_\_
    - start as early as possible;
    - be content-dependent;
    - focus on testing commercial off-the-shelf applications.

***Discuss the following questions in the groups of 3:***

1. How can you now define software testing?
2. What can potentially cause monetary or human loss?
3. Is exhaustive testing possible? Why?
4. What operations are likely to cause an operating system to fail?
5. What measures should be taken to overcome so-called «pesticide paradox»?

***Try to name all 7 principles of ST and choose one to talk about.***



## UNIT 11 CYBERSECURITY

### START-UP

#### 1. Answer the questions.

1. Has your computer ever been infected by a virus? If yes, what damage was done to it?
2. Do you know any ways of protecting information in the digital world?

### VOCABULARY

#### 1. Match the words to their definitions.

- |                      |   |
|----------------------|---|
| 1) computer security | a) irrelevant messages sent over the Internet, typically to a large number of users, for the purposes of advertising, phishing, spreading malware, etc. |
| 2) hacking           | b) conversion of data into a special code to prevent unauthorized access;   |
| 3) firewall          | c) an action taken to avoid a dangerous or undesirable event  |
| 4) precaution        | d) a computer system that isolates another computer from the internet in order to prevent unauthorized access   |
| 5) encryption        | e) gaining unauthorized access, breaching defense   |
| 6) spam              | f) protection of computer systems and networks from the theft of or damage to their hardware, software, or electronic data                              |
| 7) threat            | g) to stop smth. from happening   |
| 8) to breach         | h) to remove completely or destroy  |
| 9) to prevent        | i) a possible danger  |
| 10) to erase         | g) to break or violate  |

#### 2. Match the synonyms given below.

- |                  |                |
|------------------|----------------|
| 1) linked        | a) threat      |
| 2) danger        | b) comply with |
| 3) precautionary | c) proper      |
| 4) thief         | d) connected   |
| 5) adequate      | e) additional  |
| 6) conform to    | f) dangerous   |

- 7) supplemental
- 8) harmful
- 9) routinely
- 10) sensitive data

- g) usually
- h) vulnerable data
- i) preventive
- j) intruder

**3. Complete the table with the necessary derivatives. Pay attention to the meaning of the words.**

Verb	Noun	Adjective
protect		
		customizable
	attachment	
revolve		
	security	
		encrypted
continue		
	identity	
		prevalent
destroy		

## READING

**1. Read the text and answer the questions.**

1. What are the main threats to information stored in electronic form?
2. What are modern Internet safety techniques?
3. What harm is done by hackers? What is used to protect information from them?
4. What is the most important principle of both Internet and computer security?

### Internet Security

Internet and computer security are linked concepts for any person who owns a computer with Internet access. While the Internet can provide many tools to protect against hacking and viruses, it is also the primary source of these major computer security threats. Attaching a computer to the Internet introduces greatly increased risks for security breaches. Nevertheless, Internet and computer security can both be improved through precautionary measures, such as anti-virus protection, firewalls, and Internet safety techniques.

Computer security helps protect personal data and information from being viewed or uploaded by unauthorized users. In a computer that does not have an Internet connection, most security precautions will revolve around preventing access to a user that physically takes over the computer. Password protection and encryption programs are two types of computer security that prevent a thief or unauthorized user from getting at information stored on a computer. Once a

computer is hooked up to the Internet, however, threats become far more prevalent and complicated. In addition to password protection and encryption, Internet-using computers may require many additional programs and procedures in order to provide adequate protection from hackers and viruses.

Good Internet and computer security will help prevent hackers from accessing computer files. One primary method for hacking prevention is a hardware or software program known as a firewall. Firewalls are a type of customizable protection, which acts as a checkpoint for all incoming and outgoing information on a computer or network. If a piece of information does not conform to a firewall's settings, it will not be permitted to pass through the system without permission. Most modern operating systems provide a built-in firewall, but external applications can also be purchased for those who wish supplemental firewall protection.

Internet and computer security also aim to protect a network from viruses, which are user-created programs that can perform specific, often harmful, actions if they are accidentally downloaded. Viruses can be used to gain information for identity theft, allow hackers to send spam using a victim's email contacts, or perform needlessly destructive acts, such as erasing a hard drive. Anti-virus programs, which can be purchased or downloaded free online, help find and eliminate viruses before they can do any harm. Anti-virus programs tend to run continuously, so that all data is routinely checked for potential threats.

One of the most important principles of both Internet and computer security is intelligent user behavior. In addition to installing strong firewalls and anti-virus programs, it is important to use caution when using the Internet, just as when entering credit card information. Users should never download email attachments from strangers, and keep all accounts and sensitive computer data protected with strong, complex passwords. In addition, setting anti-virus programs to scan regularly and update automatically can help keep existing protection precautions up-to-date and functional.

<http://www.wisegeek.net/what-is-the-relationship-between-internet-and-computer-security.htm>

## **2. Read the text again and say whether these statements are true or false.**

1. Attaching a computer to the Internet is as risky as storing information in computer files.
2. Computer security can be improved through anti-virus protection, firewalls, and Internet safety techniques.
3. Password and encryption are enough to protect information from hackers and viruses.
4. Viruses perform destructive acts, such as erasing a hard drive.
5. Users should always update their security techniques as well as being cautious when using the Internet.

### 3. Make a short summary of the text.

## LANGUAGE FOCUS

### *THE PARTICIPLE*

Consult grammar rule using the link:

<https://drive.google.com/file/d/180oa7BN6J1-T0dXjhIrSjMO4nIWUCpUp/view?usp=sharing>

### 1. Study the following word combinations with the Participle I Simple and Participle II. Translate them into Russian.

#### *a) Participle I Simple*

Cybercriminals collecting financial data, Trojan programs stealing access codes, virus protection software being installed now, hackers creating malicious software programs, cryptographic protocols encrypting critical data, the computers being scanned by the security software right now, banking websites having extra layers of encryption, cybercriminals spying on you.

#### *b) Participle II*

A downloaded file, an infected website, inadequately-protected computers and servers, malicious code spread via the network, antivirus software built by world-class security firms, viruses attached to an executable file, malicious websites designed to scam individuals, a type of malware disguised as legitimate software, files sent as email attachments.

### 2. Complete the sentences using the proper form of the Participle I Simple and Participle II.

1. Cybercrime includes single actors or groups \_\_\_\_ (target) systems for financial gain or to cause disruption.
2. Security programs can detect and remove malicious code \_\_\_\_ (hide) in Master Boot Record and \_\_\_\_ (design) to encrypt or wipe data from computer's hard drive.
3. Kaspersky Lab \_\_\_\_ (recognize) for its world-class, anti-malware products can protect a range of computers and devices against cybercrime.
4. You also should be alert for spam and phishing emails \_\_\_\_ (attempt) to steal your identity.
5. The Internet banking security software \_\_\_\_ (download) now, will keep your online banking transactions secure.
6. Only anti-malware solution \_\_\_\_ (receive) regular updates will protect your device against the latest threats.

7. It is critical to have a comprehensive Internet security suite \_\_\_\_ (install) on your system.

### 3. Choose the correct form of the Participle.

1. **Activated / activating** the infected host file or program you make the virus active **enabling / having enabled** it to run and replicate on your system.
2. **Encrypted / having encrypted** all the user's information the cybercriminals demanded payment to return access to the user.
3. **Having found / finding** its way onto your system the worm made multiple copies of itself and damaged the files.
4. **Once activated / activating** Trojans can allow cybercriminals to steal your sensitive data.
5. **Applying / applied** a specially developed Trojan cybercriminals often attack a single targeted company.
6. **Having collected / collecting** information on a password for the user account a Trojan program sent the data to the criminal.
7. When **identified / identifying**, new threats are analyzed by cyber-security professionals to evolve new defenses.
8. **Having been clicked / having clicked** a fake link in the email, the user went to the criminals' server.

### 4. Make one sentence from two using an -ing clause.

*Example: The cybercriminal attracts the user's attention to the infected file. Then he gets the user to click on it.*

*Attracting the user's attention to the infected file, the cybercriminal gets the user to click on it.*

1. A small Trojan virus enters the user's computer via a vulnerability. It then downloads and installs larger Trojan viruses from the Internet.
2. Cybercriminals attacked a bank's server. After they illegally transferred funds from customers' banks accounts.
3. Fraudsters also target online banking users with fake e-mails. They request the users to enter credit card details.
4. A backdoor Trojan was employed by hackers. Then it gave cybercriminals remote control over the infected computer.
5. Banks websites have extra layers of encryption these days. They protect all sensitive customer data.
6. Worms don't require a host program in order for them to run. They spread via the network or Internet connection making multiple copies.

### 5. Complete the sentences using the proper form of the Participle.

1. Unreal is a pure C++ engine \_\_\_\_ (design) for high performance.
2. It's not rare to see people \_\_\_\_ (spend) tens or hundreds of hours on their favorite, well-designed games.
3. The system scans the environment and makes the decisions \_\_\_\_ (base) on what it 'sees'.
4. \_\_\_\_ (not become) suspicious, the company's employee entered their corporate system access password.
5. When \_\_\_\_ (pack) and \_\_\_\_ (encrypt) Trojans may evade antivirus software that's running on the victim's computer.
6. Kaspersky's research shows that more than 75% of malicious software \_\_\_\_ (create) by cybercriminals aim to infect large numbers of computers.
7. A protection update \_\_\_\_ (develop) now, will be ready for distribution soon.
8. Cybercriminals are also creating and distributing Trojan spy programs \_\_\_\_ (steal) 'online currency' from a user's e-gold or WebMoney account.
9. \_\_\_\_ (be so deeply embedded) within the system, a computer virus couldn't be detected on the user's computer for a long time.
10. After \_\_\_\_ (click) on a malicious link, the user received a scary pop-up \_\_\_\_ (claim) infection.

## SPEAKING

We are exposed to cyber dangers every day, so using the ideas and prompts below work out some Internet safety rules. You can use the Imperative or modal verbs: **can, should, must, have to.**

### Example:

Safety rules on using websites:

- Use secure websites while surfing in the web.
- You should use secure websites while surfing in the web.

	adjectives	verbs
1. websites	secure	use
2. password (name, common dictionary words, number, lower and upper case character)	strong (long, different)	create, choose, (not) share, change
3. information: address, phone number, likes and dislikes, daily routine	personal	(not) give to strangers, (not) share

4. uploading photos and videos of yourself	careful, dangerous	be
5. you/ people	rude	(not) be
6. friends	online	(not) make
7. what you download, attachment from a stranger	careful	be, (not) open,
8. information on the internet, everything	false	Be, (not) believe

## WRITING

Write down the rules you have just worked out for a *Safety Rules on Using Websites* manual. You can add some more.

## LISTENING

### SETTING THE CONTEXT

1. Why is cybersecurity important? Try to name as many reasons as possible.
2. Did you know that there is a hacker attack every 39 seconds? Does this information make you feel scared?
3. Read the following brainy quote. How do you understand it? Express your views on it.

**IF YOU THINK TECHNOLOGY  
CAN SOLVE YOUR SECURITY PROBLEMS,  
THEN YOU DON'T UNDERSTAND THE PROBLEMS  
AND YOU DON'T UNDERSTAND THE TECHNOLOGY  
- BRUCE SCHNEIER**

### ACTIVATING VOCABULARY

**Match the English words (phrases) with their Russian equivalents.**

1. investigation	a) непреднамеренно, неумышленно
2. vulnerability	b) учетные данные для входа
3. to replicate	c) перегружать; потрясать
4. unintentionally	d) расследование, исследование
5. to lure	e) копировать, воспроизводить
6. to disguise	f) заслуживающий доверия; надёжный
7. to overwhelm	g) завлекать
8. trustworthy	h) маскировать, искажать; представлять в ложном свете
9. login credentials	i) уязвимость

**Before proceeding to CHECKING YOUR UNDERSTANDING section, please follow the link to watch the video:**

[https://www.youtube.com/watch?v=AuYNXgO\\_f3Y&list=PLzdnOPI1iJNfMRZm5DDxco3UdsFegvuB7&index=7](https://www.youtube.com/watch?v=AuYNXgO_f3Y&list=PLzdnOPI1iJNfMRZm5DDxco3UdsFegvuB7&index=7)

*CHECK YOUR UNDERSTANDING*

**Match the words from column A with the words from column B to form phrases:**

1. unmanned	a. program
2. unintentional	b. updates
3. to commit	c. cyber crimes
4. executable	d. service
5. distributed denial of	e. scam
6. phishing	f. decisions
7. security	g. aerial drones

**Circle the best answer to these questions.**

1. Cybersecurity investigations are of a great importance because \_\_\_\_

- cybercrime causes huge financial problems;
- cybercriminals are elusive;
- cyber army may replace a regular army.

2. What has happened to many unmanned aerial drones in the last few years? They have been \_\_\_\_

- hijacked;
- stolen;



- hacked.
3. What are the people committing cybercrimes like?
    - They don't fit a single profile;
    - They are mostly teenagers competing for bragging rights;
    - They are organized online crime gangs.
  4. What is not listed as a possible consequence of replacing traditional weapons with cyberweapons?
    - Shutting down national surveillance systems;
    - Shutting down national energy grids;
    - Shutting down transportation systems.
  5. What does Google Security Princess do?
    - She tries to make Google's software as secure as possible;
    - She develops new Goggle products;
    - She discloses vulnerabilities in products made by Google competitors.
  6. How can an attacker infect someone's computer?
    - They might lure a victim into installing a malicious program;
    - If the software on your computer has a vulnerability, malware can install itself without even needing explicit permission;
    - All above.
  7. What use of botnets is mentioned in the video?
    - Performing a distributed denial-of-service (DDoS) attack on a web server;
    - Mining cryptocurrencies;
    - Stealing personal information.
  8. Distributed Denial of Service (DDoS) means:
    - flooding the targeted machine or resource with superfluous requests in an attempt to overload systems;
    - an attack accomplished through a network of remotely controlled, hacked computers or bots;
    - all above.
  9. What is called a phishing scam?
    - Sending emails that mimic reputable entities like banks, online resources and credit card companies to trick the receivers into sharing their financial and personal information;
    - Tricking a user into buying and downloading unnecessary and potentially dangerous software, such as fake antivirus protection;

- Tracking the keystrokes to intercept passwords and other sensitive information typed in through the keyboard.

10. Ninety percent of the time the system gets hacked \_\_\_\_

- because of a security bug;
- because of a simple mistake made by a human;
- because of the presence of some backdoors.

## UNIT 12 ROBOTICS

### START-UP

#### 1. Answer the questions.

1. What are the main areas of robot application? Why are they so widely used?
2. Are there any areas that can never be replaced by robots?

### VOCABULARY

#### 1. Match the words to their definitions.

- |                    |   |
|--------------------|---|
| 1) replicate       | a) an important positive development; a long step when walking or running                   |
| 2) law enforcement | b) to walk or travel without any real purpose or direction                                  |
| 3) drone           | c) remotely controlled  |
| 4) to roam         | d) the police or other officials who stop crime or catch criminals                          |
| 5) teleoperated    | e) an aircraft that does not have a pilot but is controlled by someone on the ground        |
| 6) warehouse       | f) a computer program that works automatically  |
| 7) chore           | g) one of the parts or features of something  |
| 8) bot             | h) a large building used for storing goods  |
| 9) facet           | i) a job or piece of work that is often boring or unpleasant but needs to be done regularly |
| 10) stride         | j) make or do something in exactly the same way, to copy or repeat smth.                    |

#### 2. Match the synonyms given below.

- |                  |               |
|------------------|---------------|
| 1) intersection  | a) harm       |
| 2) to substitute | b) to put in  |
| 3) harsh         | c) control    |
| 4) to insert     | d) to replace |
| 5) supervision   | e) wonder     |
| 6) to roam       | f) large      |
| 7) to fix        | g) severe     |
| 8) enormous      | h) to travel  |
| 9) marvel        | i) to repair  |
| 10) injury       | j) crossing   |

**3. Complete the table with the necessary derivatives. Pay attention to the meaning of the words.**

<b>Verb</b>	<b>Noun</b>	<b>Adjective</b>
wonder		
		consistent
	enforcement	
		amazing
deepen		
	supervision	
		entertaining
marvel		
	relation	
		maximum

**READING**

**1. Read the text and answer the questions.**

1. What is robotics?
2. What are the basic characteristics of robots?
3. How are robots classified?
4. Where are robots applied now?

**Robots and Robotics**

Robotics is the intersection of science, engineering and technology that produces machines, called robots, that substitute for (or replicate) human actions.

As technology progresses, so too does the scope of what is considered robotics. Earlier, 90% of all robots could be found assembling cars in automotive factories. These robots consist mainly of mechanical arms tasked with welding or screwing on certain parts of a car. Today, we're seeing an evolved and expanded definition of robotics that includes the development, creation and use of bots that explore Earth's harshest conditions, robots that assist law-enforcement and even robots that assist in almost every facet of healthcare.

While the overall world of robotics is expanding, a robot has some consistent characteristics:

1. Robots all consist of some sort of mechanical construction. The mechanical aspect of a robot helps it complete tasks in the environment for which it's designed.

2. Robots need electrical components that control and power the machinery. Essentially, an electric current (a battery, for example) is needed to power a large majority of robots.
3. Robots contain at least some level of computer programming. Without a set of code telling it what to do, a robot would just be another piece of simple machinery. Inserting a program into a robot gives it the ability to know when and how to carry out a task.

The robotics industry is still relatively young, but has already made amazing strides. From the deepest depths of our oceans to the highest heights of outer space, robots can be found performing tasks that humans couldn't dream of achieving.

Mechanical bots come in all shapes and sizes to efficiently carry out the task for which they are designed.

Pre-programmed robots operate in a controlled environment where they do simple, monotonous tasks. An example of a pre-programmed robot would be a mechanical arm on an automotive assembly line. The arm serves one function – to weld a door on, to insert a certain part into the engine, etc. – and its job is to perform that task longer, faster and more efficiently than a human.

Humanoid robots are robots that look like and/or mimic human behavior. These robots usually perform human-like activities (like running, jumping and carrying objects), and are sometimes designed to look like us, even having human faces and expressions.

Autonomous robots operate independently of human operators. These robots are usually designed to carry out tasks in open environments that do not require human supervision. An example of an autonomous robot would be the Roomba vacuum cleaner, which uses sensors to roam throughout a home freely.

Teleoperated robots are mechanical bots controlled by humans. These robots usually work in extreme geographical conditions, weather, circumstances, etc. Examples of teleoperated robots are the human-controlled submarines used to fix underwater pipe leaks during the BP oil spill or drones used to detect landmines on a battlefield.

The manufacturing industry is probably the oldest and most well-known user of robots. These robots and co-bots (bots that work alongside humans) work to efficiently test and assemble products, like cars and industrial equipment.

Shipping, handling and quality control robots are becoming a must have for most retailers and logistics companies. Because we now expect our packages arriving at blazing speeds, logistics companies employ robots in warehouses, and even on the road, to help maximize time efficiency. Right

now, there are robots taking your items off the shelves, transporting them across the warehouse floor and packaging them.

Robots can be seen all over our homes, helping with chores, reminding us of our schedules and even entertaining our kids. Additionally, robots have now evolved to do everything from autonomously mowing grass to cleaning pools.

Robots have made enormous strides in the healthcare industry. These mechanical marvels have use in just about every aspect of healthcare, from robot-assisted surgeries to bots that help humans recover from injury in physical therapy.

<https://builtin.com/robotics>

## 2. Read the text again and say whether these statements are true or false.

1. Robots replicate human actions.
2. Nowadays robots are used mainly at automotive factories.
3. All robots have mechanical, electrical and programming component.
4. Humanoid robots look like and/or mimic human behavior.
5. Autonomous robots still require human supervision.
6. Robots are rarely used in other spheres apart from manufacturing.

## 3. Make a short summary of the text.

### LANGUAGE FOCUS

#### *THE GERUND*

Consult grammar rule using the link:

<https://drive.google.com/file/d/1yTuCwBBQgywDZWsJcwKMThA9cYPKTXTu/view?usp=sharing>

## 1. Rephrase each sentence so that it begins with the Gerund as a subject.

*Example: It's important to do your own research.*

*Doing your own research is important.*

1. It's getting easier to equip robots with powerful sensing and computing systems.
2. It's necessary for industrial robots to detect objects or people nearby.
3. The current approach is to teach robots.
4. It took lots of experiments to confirm this hypothesis.
5. It's rather challenging to give a robot biped locomotion.
6. It's not hard to write code in Python.
7. It's essential to get anti-virus software that is suited to your computer type.

**2. Link these sentences using prepositions (in, without, by, instead of, before) + Gerund.**

**Example:** *Scientists conduct undersea research. They apply newly developed soft robots. Scientists conduct undersea research by applying newly developed soft robots.*

1. In Japan, engineers have taught a robot to dance. They demonstrate the movements themselves.
2. We were able to translate the article into English. We didn't use a dictionary.
3. Military robots are designed to assist troops. They carry heavy gear.
4. People don't perform certain hard and dangerous manufacturing tasks themselves. They use robots.
5. First, check reputable forums or review sites. Then download a free app or a browser plug-in.
6. Some robotic exoskeletons have industrial or military applications. They give the wearer added mobility and endurance to carry heavy loads.
7. Telemedicine robots allow doctors to check on patients at another hospital. Doctors don't need to go there.

**3. Complete the sentences using the words from the box.**

<b>looking, capable, prevent, interested, insist, concentrate, responsible</b>
--

1. Are you \_\_\_\_ in taking a robotics course, and become a roboticist?
2. Isaac Asimov's Three Laws of Robotics were designed to \_\_\_\_ a robot from harming humans.
3. A robot is an autonomous machine \_\_\_\_ of sensing its environment, carrying out computations to make decisions, and performing actions in real world.
4. Big industrial companies are \_\_\_\_ forward to deploying cost-effective, multipurpose and collaborative machines.
5. Who will be \_\_\_\_ for carrying out this task?
6. Just try to \_\_\_\_ on improving the learning algorithm of a robot.
7. They \_\_\_\_ on integrating the collaborative robots into the manufacturing process as soon as possible.

**4. Put the verbs in brackets into the Infinitive or the Gerund form. These verbs can be followed by either the Gerund or the Infinitive with a change in meaning.**

1. A collaborative robot automatically stops \_\_\_\_ (work) when anybody gets too close to the machinery.
2. I remember \_\_\_\_ (build) and \_\_\_\_ (program) my first real robot with Lego Mindstorm.
3. Don't forget \_\_\_\_ (join) us for coffee break!

4. A self-driving car detected a pedestrian and stopped \_\_\_\_ (let) him cross the road.
5. Remember \_\_\_\_ (switch off) all the appliances before leaving.
6. We recommend \_\_\_\_ (read) independent reviews and \_\_\_\_ (watch) videos to see which antivirus you might like \_\_\_\_ (use).
7. When you combine sensors, computers, actuators, and user interfaces into a robot and try \_\_\_\_ (operate) it in the real world, things still don't work perfectly.
8. The company regrets \_\_\_\_ (inform) employees that the Minsk office will close next month.
9. – The robot vacuum isn't working. I wonder what's wrong with it? – Have you tried \_\_\_\_ (recharge) the battery?
10. I forgot \_\_\_\_ (type) an extra set of parentheses, as a result the code in Python didn't work.
11. Now they regret \_\_\_\_ (invest) into this costly equipment.
12. I would recommend you \_\_\_\_ (integrate) 3D sensing technology with your robot.
13. – Have we already discussed this topic? I forget \_\_\_\_ (read) about it.

### 5. Put the verbs in brackets into the Infinitive or the Gerund form.

1. Would you like \_\_\_\_ (participate) in 3D technology conference?
2. Do you like \_\_\_\_ (read) e-books?
3. We decided \_\_\_\_ (implement) collaborative robots for pick and place operations.
4. I prefer \_\_\_\_ (learn) online to \_\_\_\_ (learn) in the classroom.
5. – Shall we leave now? – I would prefer \_\_\_\_ (wait) a little bit.
6. I'm learning \_\_\_\_ (speak) German.
7. – Do you mind \_\_\_\_ (work) extra two hours?
8. I enjoy \_\_\_\_ (drive) a car.
9. Julia wants \_\_\_\_ (practice) more English.
10. This antivirus needs \_\_\_\_ (update).
11. They decided \_\_\_\_ (adapt) their software for the maximum number of systems before release.
12. Ivan has suggested \_\_\_\_ (develop) a cross-platform application.
13. Have you finished \_\_\_\_ (write) up a defect report for a developer to look at?
14. We are planning \_\_\_\_ (start) a new project next week.

### SPEAKING

Robots are vastly used in all spheres of our lives. Speak about why and how robots are applied in the workplace, in the army, and medicine. Use the ideas and prompts below.

#### Robots in the workplace

- offer safety



- heavy machinery/ hot temperatures and sharp objects → injure the human being
- do dangerous tasks
- remove some of the risks
- not depend on the work of other people
- not take vacation time
- not take breaks
- work all the time → speed up the production
- more reliable than ...
- tasks that people don't enjoy: menial work, repetitive motion, or dangerous jobs

### **Robots in the army and search and rescue missions**

- to combat the missions (e.g. MAARS Robots – Military Advanced Armed Robots)
- be equipped with the GPS monitor
- be programmed to look at the fire and no-fire zones
- to open the doors
- to bring out the human bodies
- be used in places where the human can't reach: where the fire or natural disaster take place
- rescue people / inaccessible places

### **Robots in medicine**

- specialize in human treatment (surgical and rehabilitation robots)
- assist in the care/older physically/ mentally challenged people
- assist surgeons / perform operations
- sterilizing rooms
- delivering medical supplies, equipment
- give a prescription
- be programmed to pick the dose (according to the order from physicians or pharmacists), package it and hand over it to the individual

While speaking use the following linking words and phrases

<b>Purpose</b>	<b>Addition</b>
In order to / So as to do smth...	Moreover / Furthermore / In addition / Besides / What's more, ... In addition to... / Besides, ... Apart from..., except for
<b>Exemplification</b>	<b>Reason and cause</b>
For example	Because / As / Since

For instance Such as	Because of / On account of / Owing to / Due to
<b>Succession</b>	<b>Result</b>
First of all First / Firstly To begin with Second / Secondly / Then... Third / Thirdly After that... Finally / In short / To sum up In conclusion / Lastly / Last but not least...	As a result of: Therefore As a result Consequently For this reason

## WRITING

Write a passage about how robots serve either in military, medical or industrial sector. Use the prompts and linking words from **Speaking** to help you.

## LISTENING

### SETTING THE CONTEXT

1. Where do people use robots? Think of as many unusual ways to use robots as possible.
2. Have you ever heard about ghost kitchens? What are they like? Google the other names for the same concept.
3. You are going to watch a video about the use of robots in food processing. Modern robots are able to make burgers, patties, pizza, salads and coffee on their own. Which dish (from the ones listed above) would you like to try? Why?

### ACTIVATING VOCABULARY

**Match the English words (phrases) with their Russian equivalents.**

1. delivery	a) сбережения
2. labor costs	b) предварительная настройка
3. to hire	c) акционер; владелец акций
4. repetitive	d) настраиваемый
5. shrinking population	e) загрузочный ковш
6. customizable	f) периодически повторяющийся
7. savings (pl)	g) поставка, доставка
8. shareholder	h) торговый автомат
9. hopper	i) сокращение населения
10. preset	j) затраты на оплату труда
11. vending machine	k) нанимать, приглашать на

	работы
--	--------

**Before proceeding to CHECKING YOUR UNDERSTANDING section, please follow the link to watch the video:**

<https://www.youtube.com/watch?v=zCaDJOGnkuo>

*CHECK YOUR UNDERSTANDING*

**Match the words from column A with the words from column B to form phrases:**

l) healthy	a) kitchens
m) robotic	b) workers
n) vending	c) students
o) ghost	d) dishes
p) unskilled	e) system
q) repetitive	f) heating
r) responsibly	g) conveyor belt
s) engineering	h) machines
t) to be obsessed	i) work
u) induction	j) tasks
v) prep	k) with robotics
w) mechanical	l) farmed ingredients

**Circle the best answer to these questions.**

In *The Spice* restaurant in Boston the customer may be served healthy dishes \_\_\_\_.

- for up to 8 dollars;
- in 7 minutes;
- designed by a robot.

Restaurant owners in Japan need to have restaurants that are able to work efficiently with fewer humans because of \_\_\_\_.

- a low number of unskilled workers;
- low labor costs;
- a high number of robots with remarkable movement capabilities.

Because of the use of pizza making robots and locally sourced responsibly farmed ingredient Zume's pizzas are \_\_\_\_.

- about half the calories and half the fat of the national average for a pizza;
- about half the price of the national average for a pizza;
- all above.

MIT researchers found that \_\_\_\_.

- human and machine teams (when working together) are the most productive;
- human teams are more productive than machine teams;
- only machine teams are more productive than only human teams.

Four MIT engineering students started \_\_\_\_.

- The Spice restaurant;
- The Zume pizza;
- The Creator burger restaurant.

What is true about the Creator burger restaurant?

- The machines are able to make 240 burgers in an hour;
- The Creator burger is cheaper than a burger at McDonald's;
- All the prep work is done by the machines.

What is Sally?

- An AI driven robotic arm that works as a kitchen assistant;
- A healthy food vending machine;
- A mobile kitchen system.

Sally can be found \_\_\_\_.

- in hospitals;
- in schools;
- in virtual kitchens.

Who started a kitchen company called Cloud Kitchens?

- The former CEO of Uber;
- The former CEO of SpaceX;
- The former CEO of Google.

Zume stopped making pizzas in 2020 and refocused on mobile kitchen systems because of \_\_\_\_.

- the rise in online food deliveries these days;
- the lack of unskilled workers;
- the cost of delivery trucks.

**The video you've watched is rich in numbers.**

**Try to recall what these numbers refers to:**

1. seven dollars and fifty cents	
2. 46 years old	
3. 150 meals	
4. 240 burgers	
5. 70 locations	
6. 20,000 devices	

## REFERENCES

1. Demetriades, D. Information Technology Workshop / D. Demetriades. – Oxford : Oxford Univ. Press, 2010. – 39 p.
2. Evans, V. Career Paths: Information Technology / V. Evans, J. Dooley, S. Wright. – Express Publishing, 2014. – 40 p.
3. Evans, V. New Round-Up 6 Student's Book / V. Evans, J. Dooley. – Pearson Education Limited, 2015. – 256 p.
4. Glendinning, E. H. Oxford English Information Technology Student's Book / E. H. Glendinning, J. McEvan. – 2nd ed. – Oxford : Oxford Univ. Press, 2011. – 222 p.
5. Glendinning, E. H. Technology 1 Student's Book / E. H. Glendinning, A. Pohl. – Oxford : Oxford Univ. Press, 2012. – 135 p.
6. Glendinning, E. H. Technology 2 Student's Book / E. H. Glendinning, A. Pohl. – Oxford : Oxford Univ. Press, 2012. – 135 p.
7. Longman Dictionary of Contemporary English / Pearson Education Limited, 2007. – 1949 p.
8. Ricca-McCarthy, T. English for Telecoms and Information Technology / T. Ricca-McCarthy, M. Duckworth. – Oxford : Oxford Univ. Press, 2007. – 95 p.
9. Academic Tutorials: quick and easy learning [Электронный ресурс]. – Режим доступа: [http:// www.academictutorials.com](http://www.academictutorials.com)
10. Artificial Intelligence [Электронный ресурс]. – Режим доступа: <https://stopad.io/blog/artificial-intelligence-facts>
11. BBC [Электронный ресурс]. – Режим доступа: <http://www.bbc.co.uk/education>
12. Britanica [Электронный ресурс]. – Режим доступа: [http:// www.britanica.com/technology/automation](http://www.britanica.com/technology/automation)
13. Byte-Notes: computer science learning platform [Электронный ресурс]. – Режим доступа: [http:// www.byte-notes.com](http://www.byte-notes.com)
14. Computer Security [Электронный ресурс]. – Режим доступа: <http://www.wisegeek.net/what-is-the-relationship-between-internet-and-computer-security.htm>
15. Database Management System [Электронный ресурс]. – Режим доступа: <https://searchsqlserver.techtarget.com/definition/database-management-system>
16. Game Development [Электронный ресурс]. – Режим доступа: <https://guide.freecodecamp.org/game-development/>
17. Introduction to Algorithms [Электронный ресурс]. – Режим доступа: <https://mitpress.mit.edu/books/introduction-algorithms-third-edition>
18. Image Recognition [Электронный ресурс]. – Режим доступа: <https://sightcorp.com/knowledge-base/image-recognition/>
19. Software Testing [Электронный ресурс]. – Режим доступа: <https://www.atlassian.com/continuous-delivery/software-testing/types-of-software-testing>
20. Robotics [Электронный ресурс]. – Режим доступа: <https://builtin.com/robotics>

21. Митрошкина, Т.В. Английский язык: полный курс подготовки к централизованному тестированию и экзамену / Т.В. Митрошкина. – Минск: Тетралит, 2013. – 512 с.